

BLACK+ DECKER™

6,000, 8,000, 10,000 & 12,000 BTU
ELECTRONIC WINDOW AIR CONDITIONER

INSTRUCTION MANUAL

CATALOG NUMBER

BWAC06WT

BWAC10WT

BWAC08WT

BWAC12WT

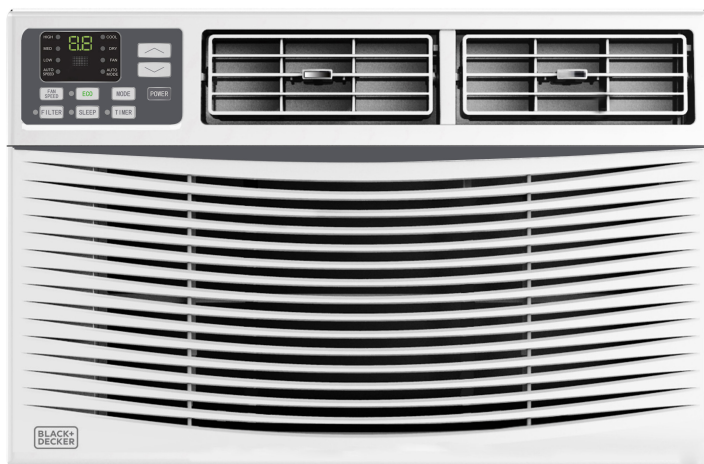

Thank you for choosing BLACK+DECKER!

PLEASE READ BEFORE RETURNING THIS PRODUCT FOR ANY REASON.

If you have a question or experience a problem with your BLACK+DECKER purchase, go to www.blackanddecker.com/instantanswers

If you can't find the answer or do not have access to the Internet, call 844-299-0879 from 10:30 a.m. to 6:30 p.m. EST Mon. - Fri. to speak with an agent. Please have the catalog number available when you call.

SAVE THIS MANUAL FOR FUTURE REFERENCE.

CONTENTS

SAFETY INFORMATION

Important Safety Instructions.....	3-7
Grounding Instructions.....	5
Safety Guidelines	6
Power Cord Operation	7

SET UP & USE

Parts Included	8
Installation & Assembly	9-13
Control Panel	14-15
Remote Control	16-17

CLEANING & CARE	18-19
-----------------------	-------

TROUBLE SHOOTING & WARRANTY

Before You Call For Service	20
Customer Service.....	20
Troubleshooting.....	21-22
Limited Warranty	23

PRODUCT REGISTRATION

Thank you for purchasing our BLACK+DECKER product. This easy-to-use manual will guide you in getting the best use of your air conditioner.

Model number

Serial number

Remember to record the model and serial numbers. They are on a label on the rear.

Date of purchase

Staple your receipt to your manual. You will need it to obtain warranty service.

SAFETY INFORMATION



DANGER

DANGER - Immediate hazards which **WILL** result in severe personal injury or death



WARNING

WARNING - Hazards or unsafe practices which **COULD** result in severe personal injury or death



CAUTION

CAUTION - Hazards or unsafe practices which **COULD** result in minor personal injury

IMPORTANT SAFETY INSTRUCTIONS



WARNING

When using electrical appliances, basic safety precautions should be followed, including the following

1. Air conditioner must be connected to proper electrical outlet with the correct electrical outlet with the correct electrical supply.
2. Proper grounding must be ensured to reduce the risk of shock and fire. **DO NOT CUT OR REMOVE THE GROUNDING PRONG.** If you do not have a three-prong electric receptacle outlet in the wall, have a certified electrician install the proper receptacle. The wall receptacle **MUST** be properly grounded.
3. Do not operate air conditioner if power cord is frayed or otherwise damaged. Avoid using it if there are any cracks or abrasion damage along the length, plug connector or if the unit malfunctions or is damaged in any manner. Contact an authorized service technician for examination, repairs or adjustments.
4. **DO NOT USE AN ADAPTER OR AN EXTENSION CORD.**
5. Do not block airflow around the air conditioner.
6. Always unplug the air conditioner before servicing it or moving it.
7. Do not install or use the air conditioner in any area where the atmosphere contains combustible gases or where the atmosphere is oily or sulphurous. Avoid any chemical coming in contact with your air conditioner.
8. Do not place any object on the top of the unit.
9. Do not use the air conditioner near a bathtub, shower or wash basin.

SAVE THESE INSTRUCTIONS
HOUSEHOLD USE ONLY

SAFETY INFORMATION

HANDLING ALKALINE BATTERIES

WARNING

When handling alkaline batteries, basic safety precautions should be followed, including the following

1. Should fluid from the battery accidentally get into your eyes, there is a threat of loss of eyesight, do not rub them. Immediately rinse your eyes with clean tap water and then consult a physician immediately.
2. Do not put the battery in a fire, expose it to heat, dismantle or modify it. If the insulation or safety valve is damaged, the battery may leak fluid, overheat or explode.
3. Do not insert the battery with the poles reversed. Doing so may cause some abnormality or a short and the battery may leak fluid, overheat or explode.
4. Keep the battery out of the reach of children. If the battery is swallowed, contact a physician immediately.
5. If the alkali fluid gets in your mouth, rinse your mouth with water and contact a physician immediately.
6. If the alkali fluid gets on your skin or clothes, it may burn your skin, thoroughly rinse the affected area with tap water.
7. Do not mix new and old batteries or other makes of batteries. The different attributes may cause the battery to leak fluid, overheat or explode.
8. This battery was not made to be recharged. Recharging this battery may damage the insulation or internal structure and may cause the battery to leak fluid, overheat or explode.
9. Do not damage or remove the label on the exterior of the battery. Doing so may cause the battery to short, leak fluid, overheat or explode.
10. Do not drop, throw or expose the battery to extreme impact. Doing so may cause the battery to leak fluid, overheat or explode.
11. Do not alter the shape of the battery. If the insulation or safety valve is damaged, the battery may leak fluid, overheat or explode.
12. Immediately remove batteries when they have lost all power. Leaving the batteries in the unit for a long time may cause the batteries to leak fluid, overheat or explode due to gas that is generated by the batteries.
13. Remove the batteries from the unit when not using the unit for an extended period of time. The batteries may leak fluid, overheat or explode due to gas that is generated by the batteries.
14. Do not apply solder directly to the batteries. The heat may cause the batteries to leak fluid, overheat or explode.
15. Do not get the batteries wet. Doing so may cause the batteries to overheat
16. Store batteries someplace out of direct sunlight where the temperature and humidity are not high. Not doing so may cause the batteries to leak fluid, overheat or explode. Also, it may cause the life and performance of the batteries to decline.
17. Follow the regulations of the local government when disposing of these batteries.

SAVE THESE INSTRUCTIONS
HOUSEHOLD USE ONLY

SAFETY INFORMATION

GROUNDING INSTRUCTIONS

ELECTRICAL REQUIREMENTS

The electrical requirements are a 115 volt 60 Hz, AC only, 15 amp. It is recommended that a separate circuit serving only the product be provided. The product is equipped with a 3-wire cord having a 3-prong grounding plug. It must be plugged into a wall receptacle that is properly installed and grounded.

This appliance must be grounded. In the event of an electrical short circuit, grounding reduces risk of electric shock by providing an escape wire for the electric current. The cord provided with this appliance is equipped with a grounding wire and a grounding plug. The plug must be plugged into an outlet that is properly installed and grounded.

Avoid the use of three prong adapters or cutting off the third grounding prong in order to accommodate a two prong outlet. This is a dangerous practice since it provides no effective grounding for the air conditioner and may result in shock hazard.

WARNING

Improper use of the grounding plug can result in a risk of electric shock.

Consult a qualified electrician or serviceman if:

- 1) The grounding instructions are not completely understood.
- 2) You are unsure that the appliance is properly grounded.
- 3) You have any questions about the grounding or electrical instructions.

POWER SUPPLY CORD

1. Avoid the use of an extension cord because of potential safety hazards under certain conditions. Have a qualified electrician or serviceman to install an outlet near the appliance.
2. If it is absolutely necessary to use longer cord sets or an extension cord, extreme care must be exercised.
 - a) Use only a grounding type 3-wire extension cord that has a 3-blade grounding plug and a 3-slot receptacle that will accept the plug on the appliance.
 - b) The marked electrical rating of the cord set or extension cord must equal to or greater than the electrical rating of the appliance. The longer cord should be arranged so that it will not drape over the counter top or table top where it can be pulled on by children or tripped over unintentionally.

NOTE: Neither BLACK+DECKER nor the dealer can accept any liability for damage to the product or personal injury resulting from failure to observe the electrical connection procedures.

SAFETY INFORMATION

SAFETY GUIDELINES

To prevent injury to the user or other people and property damage, the following instructions must be followed. Incorrect operation due to ignoring of instructions may cause harm or damage.

ALWAYS DO THIS	NEVER DO THIS	ENERGY SAVE
<ul style="list-style-type: none"> • Your air conditioner should be used in such a way that it is protected from moisture. e.g. condensation, splashed water, etc. Do not place or store your air conditioner where it can fall or be pulled into water or any other liquid. Unplug immediately. • Always transport your air conditioner in a vertical position and stand on a stable, level surface during use. • Turn off the product when not in use. • Always contact a qualified person to carry out repairs. If the supply cord is damaged it must be repaired by a qualified technician. • Keep an air path of at least 12 inches all around the unit from walls, furniture and curtains. • If the air conditioner is knocked over during use, turn off the unit and unplug from the power supply immediately. 	<ul style="list-style-type: none"> • Do not operate your air conditioner in a wet room such as a bathroom or laundry room. • Do not touch the unit with wet or damp hands or when barefoot. • Do not press the buttons on the control panel with anything other than your fingers. • Do not remove any fixed covers. Never use this appliance if it is not working properly, or if it has been dropped or damaged. • Never use the plug to start and stop the unit. • Always use the switch on the control panel to start or shut off the unit. • Do not cover or obstruct the inlet or outlet grilles. • Do not use hazardous chemicals to clean or come into contact with the unit. Do not use the unit in the presence of inflammable substances or vapour such as alcohol, insecticides, petrol, etc. • Do not allow children to operate the unit unsupervised. • Do not use this product for functions other than those described in this instruction manual. 	<ul style="list-style-type: none"> • Use the unit in the recommended room size. • Locate the unit where furniture cannot obstruct the air flow. • Keep blinds/curtains drawn. • Keep the filters clean. • Keep doors and windows closed to keep cool air in and warm air out.

SAFETY INFORMATION

LCDI POWER CORD AND PLUG

This air conditioner is equipped with an LCDI (Leakage Current Detection and Interruption) power cord that is required by UL. This power supply cord contains state-of-the-art electronics that sense leakage current. If the cord is damaged and leakage occurs, power will be disconnected from the unit.

The test and reset buttons on the LCDI Plug are used to check if the plug is functioning properly.

To test the plug:

1. Plug power cord into a grounded 3 prong outlet.
2. Press RESET (on some units a green light will turn on).
3. Press the TEST button, the circuit should trip and cut all power to the air conditioner (on some units a green light may turn off).
4. Press the RESET button for use. You will hear a click and the A/C is not ready for use.

NOTES:

- The RESET button must be engaged for proper use.
- The power supply cord must be replaced if it fails to trip when the TEST button is pressed and the unit fails to reset.
- Do not use the power supply cord as an ON/OFF switch. The power supply cord is designed as a protective device.
- A damaged power supply cord must be replaced with a new power supply cord.
- The power supply cord contains new user serviceable parts. Opening the tamper-resistant case voids all warranty and performance claims.



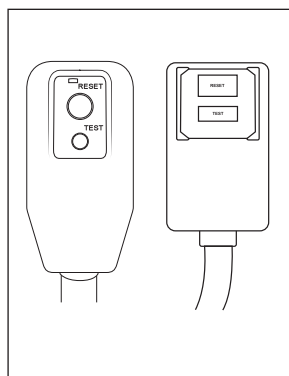





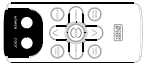
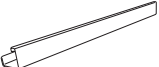

NOTE: Your units power cord and plug may differ from the one shown.



SET UP & USE

PARTS INCLUDED

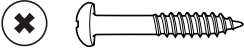
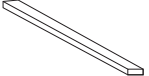
(appearance may vary)

IMAGE	PART	QUANTITY
	Window Air Conditioner	1
	Remote Control	1
	Top Mounting Rail	1
	Sponge Window Sash Seal	1
	Frame Lock	2
	Filler Panels (Marked Left & Right)	2
	Sash Lock	1
	Sponge Window Sash Seal	1
	3/8" Screws (only included with BWAC06WT & BWAC08WT)	4
	1/2" Screws	3
	3/4" Screws	4
	Foam Top Window Gasket (For use as needed)	1
	Insulation Strip (sponge)	2

SET UP & USE

INSTALLATION & ASSEMBLY FOR 6K & 8K

Some assembly is required for your new air conditioner. Please read and follow these instructions carefully.

1. This air conditioner is designed to be installed in a standard double-hung window with a window width between 22" and 36" (559mm - 914mm).
2. The air conditioner can be installed without the accordion panels to fit in a narrow window opening. See the window dimensions.
3. The lower sash (the lower part of the window that moves up and down) must allow for 14.5" of vertical clearance when open. (See Fig. 1)
4. All supporting parts must be secured to firm wood, masonry or metal.
5. The electrical outlet must be within reach of the power cord.

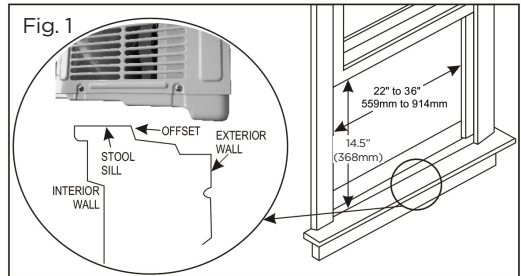

INSTALLATION & ASSEMBLY FOR 10K & 12K

Some assembly is required for your new air conditioner. Please read and follow these instructions carefully.

1. This air conditioner is designed to be installed in a standard double-hung window with a window width between 22" and 36" (559mm - 914mm).
2. The air conditioner can be installed without the accordion panels to fit in a narrow window opening. See the window dimensions.
3. The lower sash (the lower part of the window that moves up and down) must allow for 16" of vertical clearance when open. (See Fig. 2)
4. All supporting parts must be secured to firm wood, masonry or metal.
5. The electrical outlet must be within reach of the power cord.

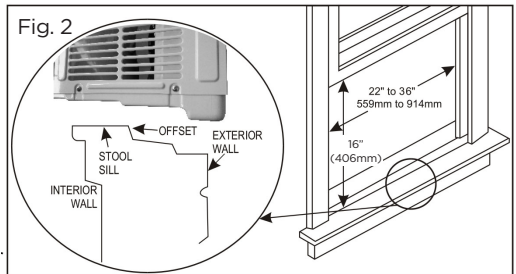

NOTE: Save the product packaging and installation instructions for future reference. Store the air conditioner in the product box when not in use for an extended amount of time.

SET UP & USE

TOP RAIL ASSEMBLY (ONLY FOR 6K & 8K)

The top rail must be assembled prior to installing the air conditioner in the window.

Tools Needed: Phillips screwdriver

1. Remove the air conditioner from the box and place on a hard flat surface.
2. Remove top rail from the bottom of the packaging material.
3. Align the hole in the top rail with those in the top of the unit. (See Fig. 3)
4. Secure the top rail to the unit with the 3/8" screws. (See Fig. 4)

NOTE: For safety reasons, all 4 screws must be used to attach top rail.

Fig. 3

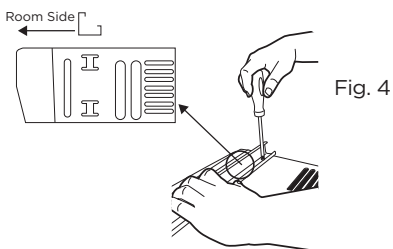
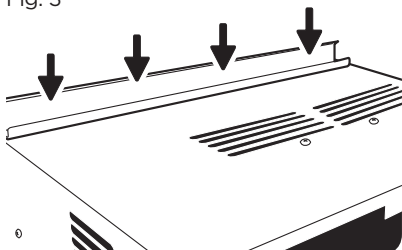

Fig. 4

CAUTION

When handling the unit, be careful to avoid cuts from the sharp metal edges and aluminum fins on the front and rear coils

SET UP & USE

HOW TO INSTALL

NOTE: Top rail and sliding panels at each side are offset to provide the proper pitch to the rear of 5/16". This is necessary for proper condensed water utilization and drainage. If you are not using the side panels for any reason, this pitch to the rear must still be maintained.

1. Place unit on floor, a bench or a table. There is a left and right window filler panel - be sure to use the proper panel for each side. When installed, the flange for securing the panel in place to the window sill will be facing into the room.
 - A. Hold the accordion panel in one hand and gently pull back the center to free the open end.
 - B. Slide the free end of the panel into the cabinet. Slide the panel down. Be sure to leave enough space to slip the top and bottom of the frame into the rails on the cabinet. (See Fig. 5)
 - C. Once the panel has been installed on the side of the cabinet, make sure it sits securely inside the frame channel by making slight adjustments. Slide the top and bottom ends of the frame into the top and bottom rails of the cabinet. (See Fig. 6)
 - D. Slide the panel all the way in and repeat on the other side.

Fig. 5

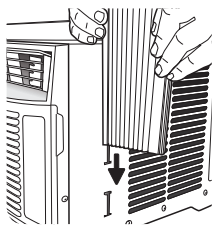
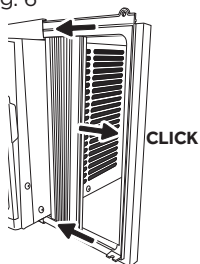

Fig. 6



NOTE: Once installed, the accordion panel cannot be removed without detaching the frame from the air conditioner.

2. Keep a firm grip on the air conditioner. Carefully place the unit into the window opening so the bottom of the air conditioner frame is against the window sill. Carefully close the window behind the top rail of the unit.

SET UP & USE

3. Extend the side panels out against the window frame. (See Fig. 7)
4. Drive three 1/2" locking screws through filler panel holes into window sash on both left and right sides. (See Fig. 8 & 9)
5. Place the frame lock between the frame extensions and the window sill. Drive 3/4" locking screws through the frame lock and into the sill on both left and right sides. (See Fig. 10)
NOTE: To prevent window sill from splitting, drill 1/8" pilot holes before driving screws.
6. To secure lower sash in place, attach right angle sash lock with two 3/4" screws. (See Fig. 11)
7. Cut foam seal strip and insert in the window space between the upper and lower sashes. (See Fig. 12)

Fig. 7

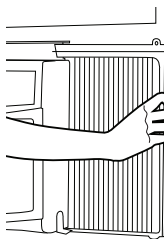

Fig. 8

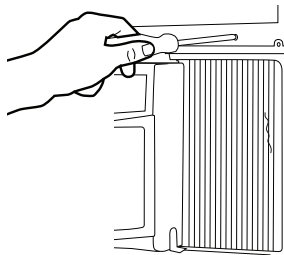

Fig. 9

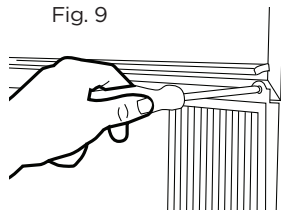

Fig. 10

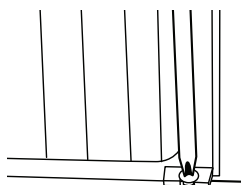

Fig. 11

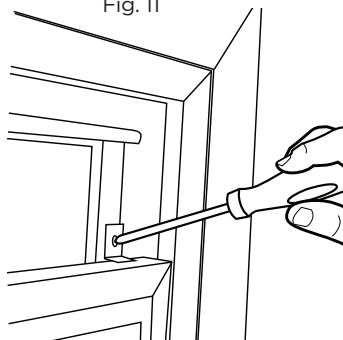
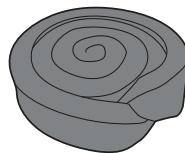

Fig. 12



SET UP & USE

IF A/C IS BLOCKED BY STORM WINDOW

Add wood or remove storm window before air conditioner is installed. (See Fig. 13)

If storm window frame must remain, be sure the drain holes or slots are not caulked or painted shut. Accumulated rain water or condensation must be allowed to drain out.

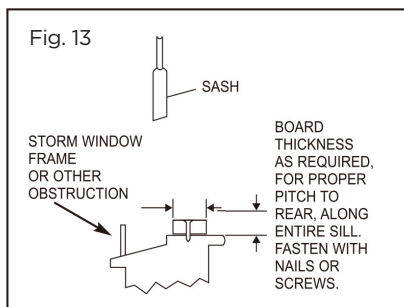

REMOVING A/C FROM WINDOW

- Turn A/C off and disconnect power cord.
- Remove sash seal from between windows and unscrew safety lock.
- Remove screws installed through frame and frame lock.
- Close (slide) side panels into frame.
- Keeping a firm grip on air conditioner, raise sash and carefully “rock” air conditioner backward to drain any condensate water in base of unit. Be careful not to spill any remaining water while lifting unit from window. Store parts WITH air conditioner.

AIR CONDITIONER USE

Operating your air conditioner properly helps you obtain the best possible results.

This section explains proper air conditioner operation.

IMPORTANT:

- If you turn off the air conditioner, wait at least 3 minutes before turning it back on. This prevents the air conditioner from blowing a fuse or tripping a circuit breaker.
- Do not try to operate your air conditioner in the cooling mode when outside temperature is below 65°F (18°C). The inside evaporator coil will freeze up and the air conditioner will not operate properly.

NOTE: In the event of a power failure, your air conditioner will operate at the previous settings when the power is restored.

SET UP & USE

CONTROL PANEL

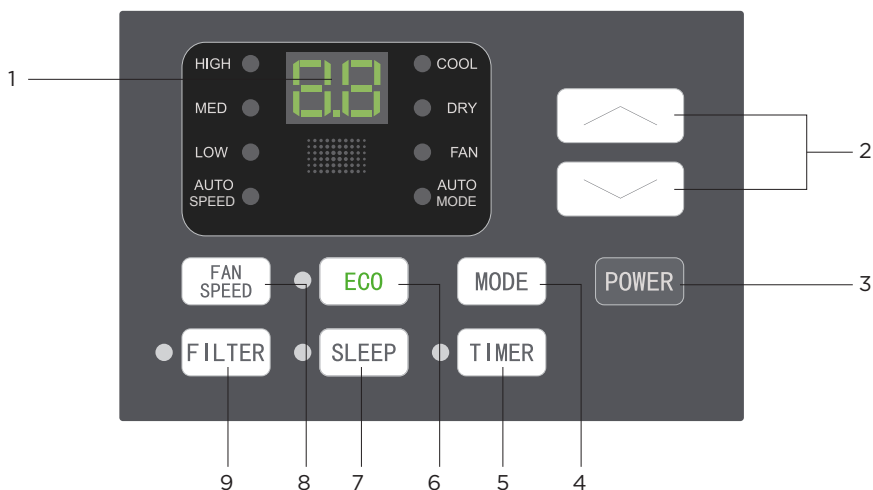

NOTE: This display always shows the room temperature in Fan Mode except when setting the Set temperature or the Timer.

NORMAL OPERATING SOUNDS

- You may hear a pinging noise caused by water hitting the condenser, or rainy days, or when the humidity is high. This design feature helps remove moisture and improve efficiency.
- You may hear the thermostat click when the compressor cycles on and off.
- Water will collect in the base pan during rain or days of high humidity. The water may overflow and drip from the outside part of the unit.
- The fan may run even when the compressor is not on.

1. **DIGITAL DISPLAY:** When in operation mode (Cool, Dry, Fan and Auto) the set temperature will be displayed. Time will be displayed when using the timer button.

2. **▲ AND ▼ BUTTON:** Use these buttons on the control panel and remote to increase or decrease the set temperature or timer. Temperature range: 61°F-88°F or 16°C-31°C.

3. **POWER BUTTON:** Turns the air conditioner on and off.

SET UP & USE

- MODE BUTTON:** Press the mode button to cycle through the various modes: Cool, Dry, Fan and Auto.
Cool Mode: The cooling function allows the air conditioner to cool the room and at the same time reduces air humidity. Press the MODE button to activate the COOL mode. To optimize the function of the air conditioner, adjust the temperature and the speed by pressing the button indicated.
Dry Mode: This function reduces the humidity of the air to make the room more comfortable. Press MODE button to set the DRY mode. An automatic function of alternating cooling cycles and fan will be activated.
Fan Mode: Allows the air conditioner to help with room ventilation. Press MODE button to set the FAN mode. With pressing FAN SPEED button, the speed changes in the following sequence: Hi, Med and Lo in FAN mode. The remote control also stores the speed that was set in the previous mode of operation. In AUTO mode, the unit automatically chooses the fan speed and the mode of operation (COOL, DRY or FAN).
- TIMER BUTTON:** Use these buttons on the control panel and remote to set the timer.
Timer Off: The timed stop is programmed by pressing TIMER button. Set the stop time by pressing the button “**Λ**” or “**V**” until the stop time displayed is to your choosing. Then press TIMER button again.
Timer On: When the unit is off, press TIMER button once and set the desired temperature by pressing the button “**Λ**” or “**V**”. Press TIMER button a second time and set the stop time by pressing the button “**Λ**” or “**V**”. Press TIMER button a third time to confirm the setting.
NOTE: Timer can be set to automatically turn off or on from 30 minutes to 24 hours. Each press of the “**Λ**” or “**V**” buttons will increase or decrease the timer. The timer can be set in 30 minute increments below 10 hours and 1 hour increments for 10 hours or above. The SET light will turn on while setting. To cancel the set function, press the TIMER button again.
- ECO BUTTON:** When the unit is in ECO mode, the indicator light on the display will turn on. In ECO mode, the compressor will turn off once the room is cooled to the set temperature but fan will continue to run in 10 minute segments. The compressor will turn back on when the room temperature rises above the user set temperature.
- SLEEP BUTTON:** Press the SLEEP button and the sleep light will illuminate after 10 seconds and all other indicator lights will be off. In SLEEP mode, the air conditioner will automatically adjust the temperature and fan speed to make the room more comfortable during the night. The set temperature will automatically raise by 1°C (1.8°F) every 30-60 minutes and at most change six times or reaches a maximum temperature of 28°C (82°F).
- FAN SPEED BUTTON:** Press the FAN SPEED button to choose the fan speed options. You can choose Hi, Med, Low in FAN mode.
- FILTER BUTTON:** After the compressor works for 500 total hours, the filter check light will turn on to remind the user to clean the filter. When the filter check light is off, it is useless to press the filter check button. When the filter check light is on, it can be turned off by pressing the filter check button.

SET UP & USE

REMOTE CONTROL

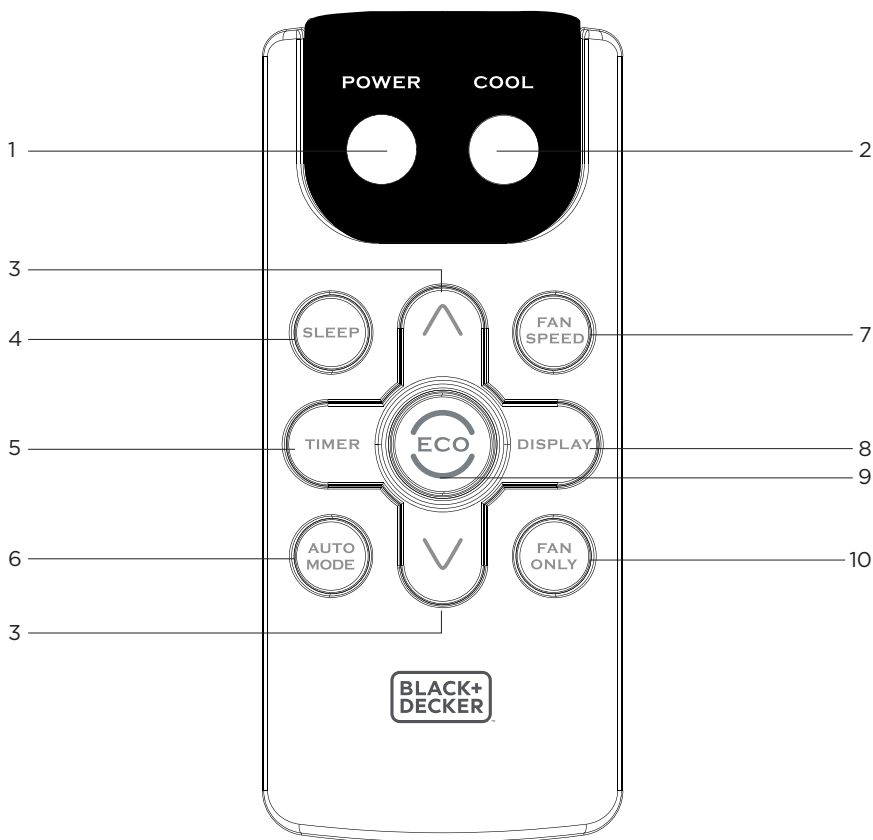

INSERTING OR REPLACING THE BATTERIES

Removing the cover on the rear of the remote control:

Insert two R03 "AAA" 1.5V batteries (not included) in the correct position (see instructions inside the battery compartment).

Replace the cover

If the remote control unit is replaced or disposed of, the batteries must be removed and discarded in accordance with current legislation as they are harmful to the environment.

NOTE: Do not mix old and new batteries or different types of AAA batteries.

SET UP & USE

1. **POWER:** Turns the air conditioner on and off.
2. **COOL:** Press the COOL button to COOL mode.
3. **▲ AND ▼:** Use these buttons on the control panel and remote to increase or decrease the set temperature or timer. Temperature range: 61°F-88°F or 16°C-31°C.
4. **SLEEP:** Press the SLEEP button, the sleep light will be on after 10 seconds, and all the left lights will be off. In SLEEP mode, the air conditioner will automatically adjust the temperature and fan speed to make the room more comfortable during the night. The set temperature will automatically raise by 1°C every 30-60 minutes and at most change six times until the set temperature is 28°C. And every running time depends on the set temperature.
5. **TIMER:** Use these buttons on the control panel and remote to set the timer.
Timer Off: The timed stop is programmed by pressing TIMER button. Set the stop time by pressing the button “▲” or “▼” until the stop time displayed is to your choosing. Then press TIMER button again.
Timer On: When the unit is off, press TIMER button once and set the desired temperature by pressing the button “▲” or “▼”. Press TIMER button a second time and set the stop time by pressing the button “▲” or “▼”. Press TIMER button a third time to confirm the setting.
NOTE: Timer can be set to automatically turn off or on from 30 minutes to 24 hours. Each press of the “▲” or “▼” buttons will increase or decrease the timer. The timer can be set in 30 minute increments below 10 hours and 1 hour increments for 10 hours or above. The SET light will turn on while setting. To cancel the set function, press the TIMER button again.
6. **AUTO:** Press AUTO button to enter into AUTO mode directly. In this mode the fan speed and the temperature are set automatically according to the room temperature (tested by the temperature sensor which is incorporated in the indoor unit).
7. **FAN SPEED:** Press the FAN button to choose the fan speed options. You can choose between 3 speeds and auto mode. Three fan speeds are Hi, Med and Lo.
8. **DISPLAY:** To press the DISPLAY button, it can switch off/on all lights of LED display.
9. **ECO:** When the unit is in ECO mode, the indicator light on the display will turn on. In ECO mode, the compressor will turn off once the room is cooled to the set temperature but fan will continue to run in 10 minute segments. The compressor will turn back on when the room temperature rises above the user set temperature.
10. **FAN ONLY:** Press the FAN ONLY button to FAN ONLY mode.

SET UP & USE

CARE AND CLEANING

Clean your air conditioner to keep it looking new and to minimize dust build up.

AIR FILTER CLEANING

The air filter should be checked at least once every month to see if it needs cleaning. Trapped particles and dust can build up in the filter and may decrease airflow as well as cause the cooling coils to accumulate frost. To clean the air filter:

1. Remove the filter by pulling down on the indents of the filter door on the front of the unit (See Fig. 13).
2. Wash the filter using liquid dish soap and warm water. Rinse the filter thoroughly. Gently shake the filter to remove excess water.
3. Let the filter dry completely before placing it into the air conditioner.
4. If you do not wish to wash the filter, you may vacuum the filter to remove the dust and other particles.

Fig. 13

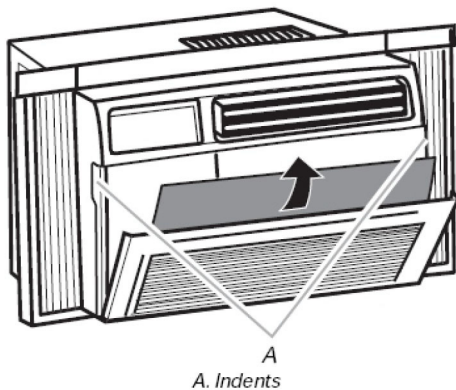

SET UP & USE

WEAR AND TEAR

To minimize wear and tear on the air conditioner, always wait at least 3 minutes before changing modes. This will help prevent the compressor from overheating and the circuit breaker from tripping.

CABINET CLEANING

To clean the air conditioner cabinet:

- Unplug the air conditioner to prevent shock or a fire hazard. The cabinet and front panel of the air conditioner may be dusted with an oil free cloth or washed with a cloth dampened in a solution of warm water and mild liquid soap. Rinse thoroughly with a damp cloth and wipe dry.
- Never use harsh cleaners, wax or polish on the cabinet front.
- Be sure to wring excess water from the cloth before wiping around the controls. Excess water in or around the controls may cause damage to the air conditioner.

WINTER STORAGE

To store the air conditioner when it is not in use for an extended period of time, remove it carefully from the window according to the installation instructions and cover it with plastic or place it in the original box.

TROUBLESHOOTING & WARRANTY

BEFORE YOU CALL FOR SERVICE

IF THE AIR CONDITIONER FAILS TO OPERATE:

- A) Check to make sure that the air conditioner is plugged in securely. If it is not, remove the plug from the outlet, wait 10 seconds and plug it in again securely.
- B) Check for a blown circuit fuse or a tripped main circuit breaker. If these seem to be operating properly, test the outlet with another appliance.

IF NONE OF THE ABOVE SOLVES THE PROBLEM, CONTACT A QUALIFIED TECHNICIAN. DO NOT TRY TO ADJUST OR REPAIR THE AIR CONDITIONER YOURSELF.

CUSTOMER SERVICE

IMPORTANT

DO NOT RETURN THIS PRODUCT TO THE STORE

If you have a problem with this product, please contact the W Appliance Co. Customer Satisfaction Center at 844-299-0879.

**DATED PROOF OF PURCHASE, MODEL # AND SERIAL #
REQUIRED FOR WARRANTY SERVICE**

TROUBLESHOOTING & WARRANTY

Troubleshoot your problem by using the chart below. If the air conditioner still does not work properly, contact W Appliance Co. customer service center. Customers must never troubleshoot internal components.

TROUBLE	POSSIBLE CAUSE	POSSIBLE REMEDY
The air conditioner will not start	The air conditioner is unplugged	<ul style="list-style-type: none"> • Make sure the air conditioner plug is pushed completely into the outlet.
	The fuse is blown/circuit breaker is tripped	<ul style="list-style-type: none"> • Check the house fuse/circuit breaker box and replace the fuse or reset the breaker.
	Power failure	<ul style="list-style-type: none"> • The unit will automatically restart when power is restored. • There is a protective time delay (approx. 3 minutes) to prevent tripping of the compressor overload. For this reason, the unit may not start normal cooling for 3 minutes after it is turned back on.
	The current interrupter device is tripped	<ul style="list-style-type: none"> • Press the RESET button located on the power cord plug. • If the RESET button will not stay engaged, discontinue use of the air conditioner and contact a qualified service technician.
The air conditioner does not cool as it should	Air flow is restricted	<ul style="list-style-type: none"> • Make sure there are no curtains, blinds or furniture blocking the front of the air conditioner.
	The temperature control may not be set correctly.	<ul style="list-style-type: none"> • Lower the set thermostat temperature.
	The air filter is dirty	<ul style="list-style-type: none"> • Clean the filter. See the Cleaning & Care section of the manual.
	The room may be too warm	<ul style="list-style-type: none"> • Please allow time for the room to cool down after turning on the air conditioner.
	Cold air is escaping	<ul style="list-style-type: none"> • Check for open furnace registers and cold air returns.
	The cooling coils are frozen	<ul style="list-style-type: none"> • See “Air Conditioner Freezing Up” below.
The air conditioner is freezing up	Ice blocks the air flow and stops the air conditioner from cooling the room	<ul style="list-style-type: none"> • Set the MODE dial to HIGH FAN or HIGH COOL and set the thermostat to a higher temperature.
The remote control is not working	The batteries are inserted incorrectly. The batteries may be dead	<ul style="list-style-type: none"> • Check the position of the batteries. • Replace the batteries.

TROUBLESHOOTING & WARRANTY

TROUBLE	POSSIBLE CAUSE	POSSIBLE REMEDY
Water is dripping outside	Hot and humid weather	<ul style="list-style-type: none">• This is normal.
Water is dripping inside the room	The air conditioner is not correctly tilted outside	<ul style="list-style-type: none">• For proper water drainage, make sure the air conditioner is slightly tilted downward from the front of the unit to the rear.
Water collects in the base pan	Moisture removed from the air is draining into the base pan	<ul style="list-style-type: none">• This is normal for a short period in areas with low humidity and normal for a longer period in areas with high humidity.

TROUBLESHOOTING & WARRANTY

LIMITED WARRANTY

Any repair, replacement, or warranty service, and all questions about this product should be directed to W Appliance Co. at **844-299-0879** from the USA or Puerto Rico.

W Appliance Co. warrants to the original purchaser that the product will be free from defects in material, parts and workmanship for the period designated for this product. The warranty commences the day the product is purchased and covers up to a period of **1 year (12 months) for labor/1 year (12 months) for parts (manufacturing defects only)/and a total of 5 years (60 months) for compressor part only.**

W Appliance Co. agrees that it will, at its option, replace the defective product with either a new or remanufactured unit equivalent to your original purchase during the warranty period.

Exclusions: This warranty does not apply to the below:

1. If the appearance or exterior of the product has been damaged or defaced, altered or modified in design or construction.
2. If the product original serial number has been altered or removed or cannot be readily determined.
3. If there is damaged due to power line surge, user damage to the AC power cord or connection to improper voltage source.
4. If damage is due to general misuse, accidents or acts of God.
5. If repair attempts are done by unauthorized service agents, use of parts other than genuine parts or parts obtained from persons other than authorized service companies.
6. On units that have been transferred from the original owner.
7. On products that have been purchased as refurbished, like new, second-hand, in a "As-Is" or "Final Sale" terms.
8. To products used in a commercial or rental setting.
9. To products used in settings other than ordinary household use or used other than in accordance with the provided instructions.
10. To damages for service calls for improper installations.
11. To glass parts and other accessory items that are included with the unit.
12. Transportation and shipping costs associated with the replacement of the unit.
13. Food loss for loss due to product failure or delay in service, repair or replacement.
14. Service calls to instruct you how to use your product.
15. Service calls to repair or replace the house fuse, reset the circuit breaker or correct the wiring in the house.

REPAIR OR REPLACEMENT AS PROVIDED UNDER THIS WARRANTY IS THE EXCLUSIVE REMEDY OF THE CUSTOMER; W Appliance Co. SHALL NOT BE LIABLE FOR ANY INCIDENTAL OR CONSEQUENTIAL DAMAGES FOR BREACH OF ANY EXPRESS OR IMPLIED WARRANTY ON THIS PRODUCT, EXCEPT TO THE EXTENT PROHIBITED BY APPLICABLE LAW. ANY IMPLIED WARRANTY OF MERCHANTABILITY OF FITNESS FOR A PARTICULAR PURPOSE ON THIS PRODUCT IS LIMITED TO THE DURATION OF THE WARRANTY.

Some states do not allow the exclusion or limitations of incidental or consequential damages, or limitations on how long the warranty lasts. In these cases the above exclusions or limitations may not apply to you. This warranty gives you specific legal rights and you may also have other rights which vary from state to state.

Obtaining Service: To obtain service, product literature, supplies or accessories please call **844-299-0879** to create a ticket for exchange/repair. Please make sure to provide the date of purchase, model number and a brief description of the problem. Our customer service representative will contact you or send detailed return instructions.

W Appliance Co. does not warrant that the appliance will work properly in all environmental conditions, and makes no warranty and representation, either implied or expressed, with respect to the quality, performance, merchantability, or fitness for a particular purpose other than the purpose identified within this user's manual. W Appliance Co. has made every effort to ensure that this user's manual is accurate and disclaims liability for any inaccuracies or omissions that may have occurred. Information in this user's manual is subject to change without notice and does not represent a commitment on the part of W Appliance Co.. W Appliance Co. reserves the right to make improvements to this user's manual and/or to the products described in this user's manual at any time without notice. If you find information in this manual that is incorrect, misleading, or incomplete, please contact us at **844-299-0879**.

W Appliance Co.
1356 Broadway
New York, NY 10018

BLACK & DECKER, BLACK+DECKER, the BLACK & DECKER and BLACK+DECKER logos and product names and the orange and black color scheme are trademarks of The Black & Decker Corporation, used under license. All rights reserved.

Product in this box may differ slightly from that pictured. Does not affect function. Not all accessories shown in photography are included in this package.

Imported by W Appliance, Inc., 1356 Broadway, New York, NY 10018