

**THE ASSEMBLY INSTRUCTION
OF
3PCS Edison Bistro Set**

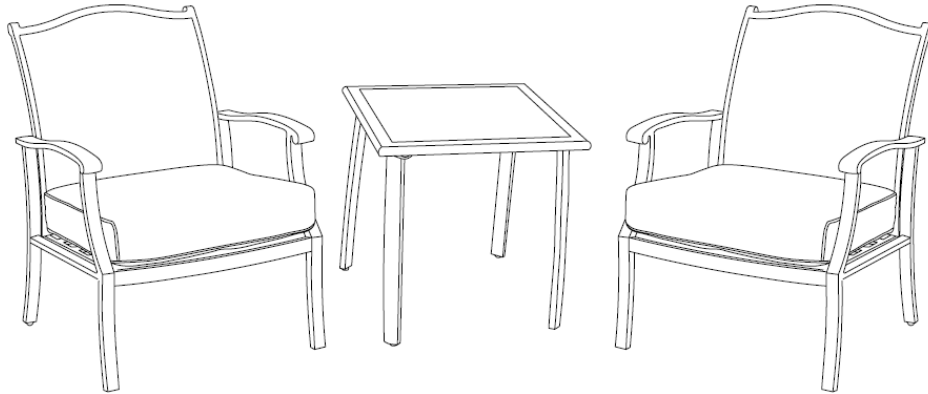

Caution:

This 3PCS Edison Bistro Set was made for the explicit purpose of providing outdoor functions and is not to be used as a toy. This product is not intended for Inclement /Severe weather in any form including, but not limited to: rain, hail, sleet, snow and/or wind. The Manufacturer recommends that with formidable weather approaching you store and/or cover this table. Do not locate structure near any open flame. Do not use structure as a support. Do not shake, lean or climb on it. A competent adult should supervise children under the age of 10 at all times. This product is NOT intended for commercial use and will void the warranty.

LIMITED WARRANTY

Yotrio Corporation, Nogales, CA. 91748, extends a two year frame and one year fabric limited warranty to the original purchaser as a sign of our dedication to the highest possible quality standards. The warranty is design to cover this 3PCS Edison Bistro Set under normal residential use. This Warranty is non-transferable and void if the furniture is used in non-residential environment and/or has been abused. The warranty also becomes void in the event the 3PCS Edison Bistro Set has been damage by acts of God, calamity or misuse. This warranty does not cover in the event of inclement weather such as rain, hail, sleet, snow or wind. We reserve the right to make substitutions with similar merchandise, if the model in questions is no longer in production. The manufacturer recommends that with ANY formidable weather approaching you disassemble and store your 3PCS Edison Bistro Set in a safe location.

For further details please refer to the CAUTION warning section of this Assembly instruction.



DO NOT RETURN TO RETAILER

IF YOU HAVE ANY QUESTIONS OR CONCERNS
PLEASE VISIT OUR WEBSITE AT:

www.yotrioint.com

OR TOLL FREE AT:









1-866-905-4107

MONDAY-FRIDAY 8:30 AM TO 5:00 PM PACIFIC STANDARD TIME /
11:30 AM TO 8:00PM EASTERN STANDARD TIME

YOTRIO CUSTOMER CARE

ASSEMBLY INSTRUCTION OF 3PCS EDISON BISTRO SET

JDC-1357D

	Part list	Description	Qty
A		Chair Back	1
B		Left Arm	1
C		Right Arm	1
D		Chair Base	1
E		Bolt (E)	6
F		Bolt (F)	2
G		Washer	8
H		Bolt Cover	8
I		Allen Wrench	1

Step 1: Assemble Left Arm (B) and Right Arm (C) together with Chair Base (D) by using Bolts (E) and Washers (G). But do not tighten them. Please see Fig. 1

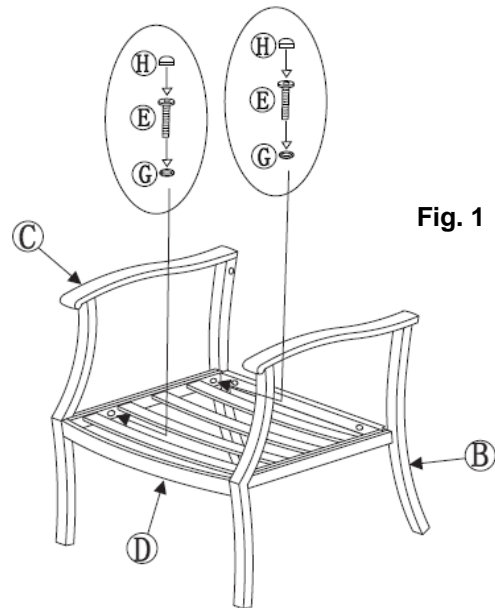

Fig. 1

Step 2: Assemble Chair Base (D) together with Chair Back (A) by using Bolts (E) and Washers (G). And then assemble Chair Back (A) together with Left Arm (B) and Right Arm (C) by using Bolts (F). Please tighten all Bolts and put on the Bolt Covers (H) on the Bolts (E) and Bolts (F). Please see Fig. 2

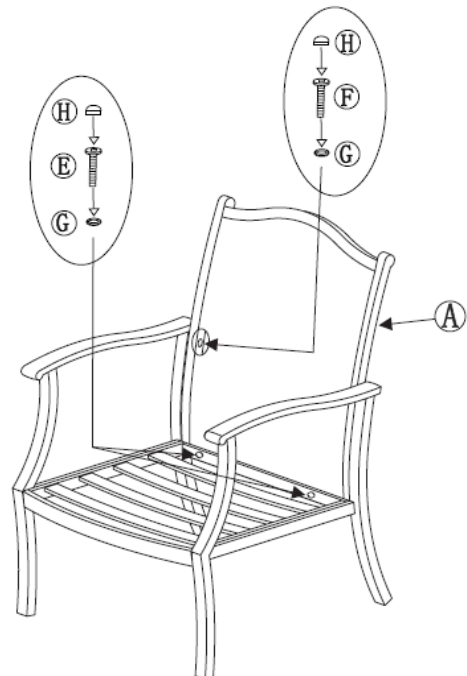
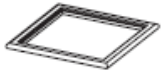







Fig. 2

ASSEMBLY INSTRUCTION OF 3PCS EDISON BISTRO SET

JDT-2049-2020

	Part list	Description	Qty
A		Table Rim	1
B		Table Leg	4
C		Table Top	1
D		Bolt	8
E		Washer	16
F		Bolt Cover	16
G		Allen Wrench	1

Step 1: Lay down the Table Rim (A) on a soft surface such as a blanket. Assemble Table Legs (B) and the Table Rim (A) by using Bolts (D) and Washers (E). Tighten all the bolts and put all the Bolt Covers (F) on. Please see Fig. 1

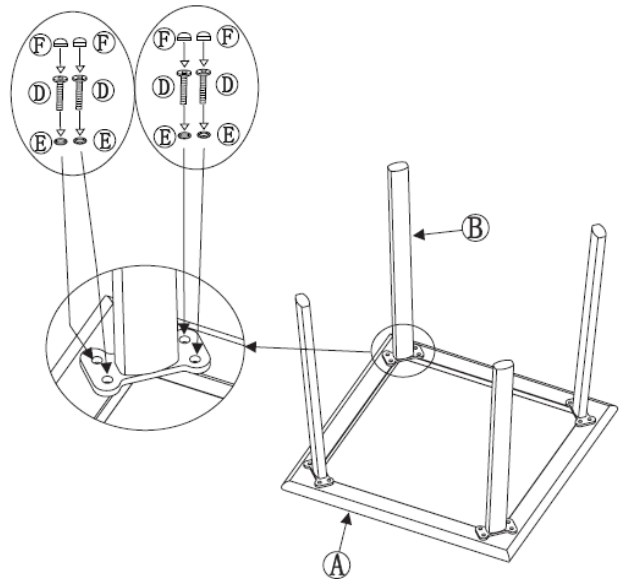

Fig. 1

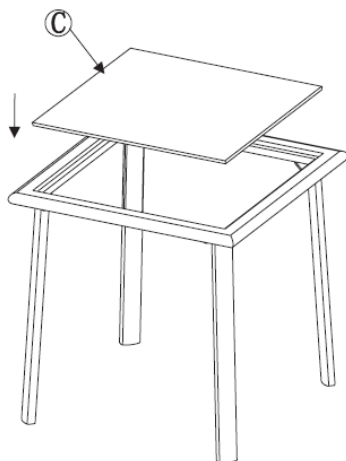

Fig. 2

Step 2: Turn the table upside down on a flat surface and carefully put the Table Top (C) on. Please see Fig. 2