



LG

Life's Good

OWNER'S MANUAL

MICROWAVE OVEN

PLEASE READ THIS OWNER'S MANUAL THOROUGHLY
BEFORE OPERATING.

LCSP1110ST

TABLE OF CONTENTS

SAFETY	3-5	USING THE PIZZA OVEN	17, 18
Precautions to Avoid Possible Exposure		Cooking with Auto Pizza	17
to Excessive Microwave Energy	3	Cooking with the Bake Feature.....	18
Grounding Instructions	3	TROUBLESHOOTING	19-21
Electronic Interference	3	Questions and Answers	19, 20
Important Safety Instructions	4, 5	Before Calling for Service	21
UNDERSTANDING YOUR MICROWAVE OVEN	6-9	Federal Communications Commission Radio	
Specifications	6	Frequency Interference Statement	21
Installation	6	WARRANTY	21
Parts and Accessories	7		
Control Panel Features	7		
Cookware Guide	8		
Tips for Microwave Cooking.....	9		
Cleaning	9		
USING YOUR MICROWAVE OVEN	10-17		
Clock/Kitchen Timer/Child Lock/Add 30 Seconds.....	10		
More & Less Functions/Timed Cooking/			
Multistage Cooking.....	11		
Microwave Power Levels	12		
Quick Touch Cooking	13		
Reheat.....	14		
Auto Defrost/Auto Defrost Table	15		
Cooking Tips	16, 17		

Thank you for purchasing a LG microwave oven.

Please record the model number and serial number of this unit for future reference. We also suggest you record the details of your contact with LG (LG Electronics U.S.A., Inc.) concerning this unit.

Staple your receipt here for proof of purchase.

Model No: _____
 Serial No: _____
 Dealer: _____

 Dealer Phone No: _____

Customer Relations
 LG Electronics U.S.A., Inc.
 Service Division Bldg. #3
 201 James Record Rd.
 Huntsville, AL 35824-0126

SAFETY

PRECAUTIONS TO AVOID POSSIBLE EXPOSURE TO EXCESSIVE MICROWAVE ENERGY

- DO NOT attempt to operate this oven with the door open, since open-door operation can result in harmful exposure to microwave energy. **It is important not to defeat or tamper with the safety interlocks.**
- DO NOT operate the oven if it is damaged. It is particularly important that the oven door close properly and that there is no damage to the:
 - door (bent),
 - hinges and latches (broken or loosened),
 - door seals and sealing surfaces.
- DO NOT place any object between the oven front face and the door or allow soil or cleaner residue to accumulate on sealing surfaces.
- THE OVEN should not be adjusted or repaired by anyone except properly qualified service personnel.

GROUNDING INSTRUCTIONS

This appliance must be grounded! If an electrical short circuit occurs, grounding reduces the risk of electric shock by providing an escape wire for the electric current. This appliance

is equipped with a cord having a grounding wire with a grounding plug. Insert the plug into an outlet that is properly installed and grounded.

WARNING

If you use the grounding plug improperly, you risk electric shock.

Ask a qualified electrician or the Sears Service Department if you do not understand the grounding instructions or if you are not certain whether the appliance is properly grounded.

This appliance has a short power supply cord to reduce the risk of anyone tripping over or becoming entangled in the cord. You may use an extension cord if you are careful.

If you use an extension cord, be sure that:

- The extension cord has the same electrical rating as the appliance.
- The marked rating of the extension cord shall be equal to or greater than the electrical rating of the appliance.
- The extension cord is a grounding-type 3-wire cord.
- The extension cord does not drape over a countertop or tabletop, where it can be pulled on by children or tripped over accidentally.
- The electrical cord is dry and not pinched or crushed in any way.

NOTE: This oven draws 12.5 amperes at 120 volts, 60 hz.

ELECTRONIC INTERFERENCE

1. Microwave oven operation may interfere with TV, phone, or radio reception.
2. When there is interference, it may be reduced or eliminated by taking the following measures:
 - a. Clean the door and the sealing surfaces of the oven.
 - b. Reorient the receiving antenna of radio or TV.
 - c. Relocate the microwave oven in relation to the TV, phone, or radio.
 - d. Move the microwave oven away from the receiver.
 - e. Plug the microwave oven into a different outlet so the microwave oven and receiver are on different branch circuits.

SAFETY

IMPORTANT SAFETY INSTRUCTIONS

The safety instructions below will tell you how to use your microwave oven to avoid harm to yourself or damage to your oven.

⚠ WARNING – To reduce the risk of burns, electric shock, fire, injury to persons, or exposure to excessive microwave energy:

1. **Read all the instructions before using your microwave oven.**
2. **Do not allow children to use this oven without close supervision!**
3. Read and follow the specific **PRECAUTIONS TO AVOID POSSIBLE EXPOSURE TO EXCESSIVE MICROWAVE ENERGY** found on page 3.
4. **Do not tamper with the built-in safety switches on the oven door!** The oven has several built-in safety switches to make sure the power is off when the door is open.
5. **When cleaning the door and the surfaces that touch the door, use only mild, nonabrasive soaps or detergents and a sponge or soft cloth.**
6. **If your oven is dropped or damaged,** have it thoroughly checked by a qualified service technician before using it again.
7. **To avoid a fire hazard:**
 - a) **Do not severely overcook foods.** It can cause a fire in the oven.
 - b) **Do not use recycled paper products in your oven.** They can contain particles that can cause arcing or may ignite.
 - c) **Do not overcook potatoes.** Overcooking could cause a fire.
 - d) **Do not store combustible items** (bread, cookies, etc.) **in the oven** because if lightning strikes the power lines, it may cause the oven to turn ON.
 - e) **Do not use wire twist-ties in the oven.** Be sure to remove them before placing the item in the oven.
 - f) **Do not use the cavity for storage purposes.** Do not leave paper products, cooking utensils, or food in the cavity when not in use.
8. **If a fire should start:**
 - a) **Keep the oven door closed.**
 - b) **Turn the oven off.**
 - c) **Disconnect the power cord or shut off the power at the fuse or circuit breaker panel.**
9. **Do not use this oven for commercial purposes.** This microwave is made for household use only.
10. **Install or locate this appliance in accordance with the provided installation instructions.**
11. **To avoid electric shock:**
 - a) **This appliance must be grounded!** Connect it only to a properly grounded outlet. (See the Grounding Instructions on page 3.)
 - b) **Do not operate this appliance if it has a damaged cord or plug,** if it is not working properly, or if it has been damaged or dropped.
 - c) **Do not immerse the electrical cord or plug in water.**
 - d) **Keep the cord away from heated surfaces.**
 - e) This appliance should be serviced only by qualified service personnel.
12. Liquids such as water, coffee, or tea are able to be overheated beyond the boiling point without appearing to be boiling due to surface tension of the liquid. Visible bubbling or boiling when the container is removed from the microwave oven is not always present. **THIS COULD RESULT IN VERY HOT LIQUIDS SUDDENLY BOILING OVER WHEN THE CONTAINER IS DISTURBED OR WHEN A SPOON OR OTHER UTENSIL IS INSERTED INTO THE LIQUID.** To reduce the risk of injury to persons:
 - 1) Do not overheat the liquid.
 - 2) Stir the liquid both before and halfway through heating it.
 - 3) Use extreme care when inserting a spoon or other utensil into the container once heating has begun.
 - 4) Do not use straight-sided containers with narrow necks.
 - 5) After heating, allow the container to stand in the microwave oven for a short time before removing the container.
13. **Keep the glass tray and the turntable roller rest in the oven when you are cooking.**
14. **Do not use the oven outdoors. Do not store the oven outdoors. Do not use this product near water.**
 - For example, near a kitchen sink, in a wet basement, near a swimming pool or similar location.
15. **Do not cover or block any openings in the oven.**
16. **Do not run the microwave oven empty.**
17. **Do not let the cord hang over the edge of a table or counter.**
18. **Do not heat glass turntable excessively.**
 - Do not cook bacon directly on the glass turntable.
 - Do not allow the gray film on special microwave cooking packages to touch the glass turntable. Put the package on a microwave-safe dish.
 - Keep a browning dish at least 3/16 in. (.5 cm) above the glass turntable. If you use the browning dish incorrectly, you could break the glass turntable.
19. **Be careful not to chip or scratch the edges of the turntable.** Chips or scratches may cause the turntable to break during use.
20. Some items (such as whole eggs and sealed containers, for example, closed glass jars) are able to explode and should not be heated in this oven.
21. **Use this appliance only for its intended use as described in this manual.** Do not use corrosive chemicals or vapors in this appliance. This type of oven is specifically designed to heat, cook, or dry food. It is not intended for industrial or laboratory use.

SAVE THESE INSTRUCTIONS!

SAFETY – PIZZA OVEN

IMPORTANT SAFETY INSTRUCTIONS

⚠WARNING – When using electrical appliances, especially around children, basic safety precautions should also be followed, including the following:

1. Read all the instructions before using your pizza oven.
2. Do not touch hot surfaces. Use handles or knobs.
3. To protect against electrical hazards, do not immerse cord, plug, or the appliance in water or other liquid.
4. Close supervision is necessary when any appliance is used by or near children.
5. Unplug from outlet before cleaning. Allow to cool before putting on or taking off parts or cleaning.
6. Do not operate any appliance with a damaged cord or plug, or after the appliance malfunctions or has been dropped or damaged in any manner. Return appliance to nearest authorized service center for examination, repair, or adjustment.
7. The use of accessory attachments not recommended by the manufacturer may cause hazards.
8. Keep the cord away from heated surfaces. Do not let the cord hang over the edge of table or counter, as it could be pulled off.
9. Do not use outdoors.
10. Do not use on or near a hot gas or electric burner or in a heated oven.
11. Do not use appliance for other than its intended use.
12. Oversized foods, metal foil packages, or utensils must not be inserted into this appliance, as they may create a fire or electrical hazard.
13. A fire may occur if this oven is covered or touching flammable material, including curtains, draperies, walls, etc. when in operation.
14. Do not attempt to dislodge food when this appliance is plugged in.
15. Do not clean with metal scouring pads. Pieces can break off the pad and touch electrical parts, creating a risk of electrical shock.
16. Do not use paper products when operated in pizza oven mode.
17. Do not store any materials other than the manufacturer's recommended accessories in this oven when not in use.
18. Do not cover racks, tray, or any other part of the oven with aluminum foil. This will cause overheating of the oven.
19. Extreme caution must be used when moving an appliance containing hot oil or other liquids.
20. Always attach plug to appliance first, then plug cord into the wall outlet. To disconnect, turn controls to OFF then remove plug from wall outlet.
21. Use extreme caution when removing tray or disposing of hot grease.
22. Extreme caution should be exercised when using containers constructed of other than metal or glass.
23. Do not place any of the following materials in the oven: paper, cardboard, or plastic.

SAVE THESE INSTRUCTIONS!

UNDERSTANDING YOUR MICROWAVE OVEN

SPECIFICATIONS

Power Supply		120 VAC, 60 Hz
Rated Power Consumption	Microwave	1,450 W
	Pizza Oven	1,400 W
Power Output	Microwave	1,000 W*
	Pizza Oven	1,400 W
Frequency		2,450 MHz
Rated Current	Microwave	12.5 A
	Pizza Oven	12.5 A
Overall Dimensions (W x H x D)		19 ⁵ / ₁₆ " x 15 ¹ / ₂ " x 17 ¹ / ₄ " (51 x 39 x 44 cm)
Oven Cavity Dimensions (W x H x D)		14 ¹ / ₁₆ " x 8 ⁷ / ₈ " x 13 ¹ / ₄ " (37 x 23 x 34 cm)
Capacity of Oven Cavity		1.1 Cu. Ft.

*IEC 60705 RATING STANDARD

Specifications subject to change without prior notice.

INSTALLATION

Carefully remove your microwave oven from the shipping carton. Be sure to remove all packing materials from the oven cavity and pizza cavity before use.

A. Circuits

For safety purposes this oven must be plugged into a 20-amp circuit. No other electrical appliances or lighting circuits should be on this line. If in doubt, consult a licensed electrician.

B. Placement of the Oven

Your microwave oven can be placed easily in your kitchen, family room, or anywhere else in your home. Place the oven on a flat surface such as a kitchen countertop or a specially designed microwave oven cart at least 39.4 in. (100 cm) from the floor. Do NOT place your microwave oven over a range, cooktop, or other heat-producing appliances. Free airflow around the oven is important. Allow at least 4 in. (10 cm) of space at the top, sides, and back of the oven for proper ventilation.

C. Turntable Installation

Place the turntable roller rest in the circle on the oven floor and then place the glass turntable on the turntable roller rest.

NOTES:

- Never place the glass turntable in the oven upside down. Blocking the air inlet and/or outlet openings can damage the oven.
- Never operate the oven without the turntable in place.

D. Pizza Oven Pan

Place the pizza oven pan in the pizza drawer.

NOTE:

- Never operate the pizza oven without the pizza oven pan in place.

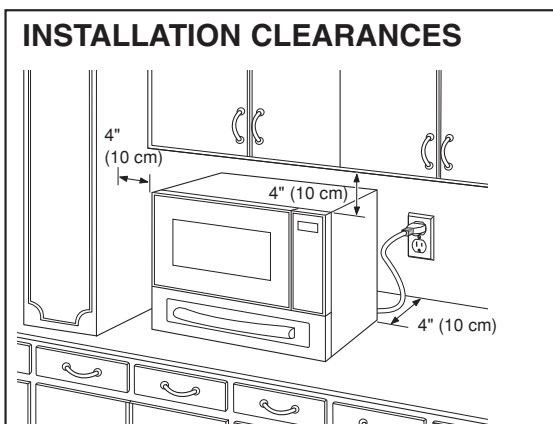

UNDERSTANDING YOUR MICROWAVE OVEN

PARTS AND ACCESSORIES

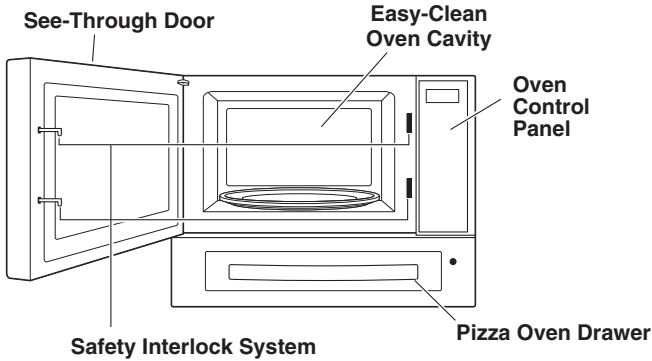

Your oven includes the following accessories:

- 1 Use and Care Guide
- 1 Glass Turntable
- 1 Turntable Roller Rest
- 1 Pizza Oven Pan

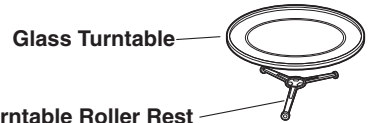

Glass Turntable

Turntable Roller Rest

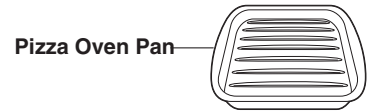

Pizza Oven Pan

CONTROL PANEL FEATURES

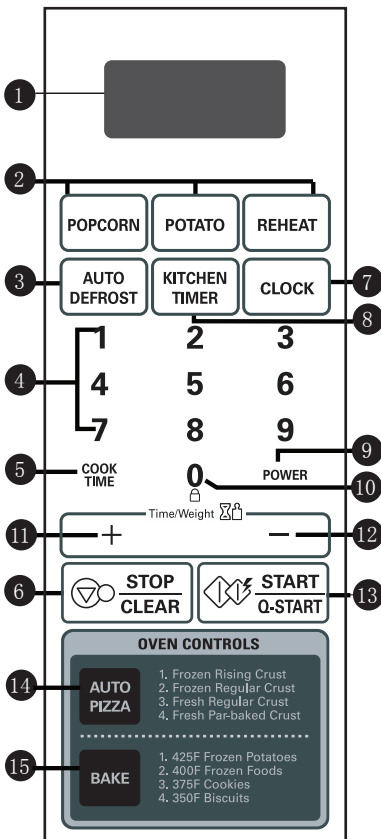

1. **DISPLAY.** The Display includes a clock and indicators to tell you time of day, cooking time settings, and cooking functions selected.
2. **QUICK TOUCH COOKING.** These pads allow you to cook most of your favorite foods without having to select cooking times and power levels.
3. **AUTO DEFOST.** Touch this pad to automatically defrost frozen meat, poultry, or fish, according to weight, up to 6.0 lbs.
4. **NUMBER PADS.** Touch number pads to enter cooking times, cook powers, quantities, weights, or food categories.
5. **COOK TIME.** Touch this pad to set a cooking time.
6. **STOP/7 @5 F.** Touch this pad to stop the oven or clear entries.
7. **CLOCK.** Touch this pad to enter the time of day.
8. **KITCHEN TIMER.** Touch this pad to use your microwave oven as a kitchen timer.
9. **POWER.** Touch this pad to set the cooking power level.
10. **CHILD LOCK.** Touch and hold the 0 pad for 3 seconds to activate this feature. Touch and hold the 0 pad for 3 seconds again to deactivate this feature.
11. **MORE.** Touch this pad to add 10 seconds of cooking time each time it is pressed.
12. **LESS.** Touch this pad to subtract ten seconds of cooking time each time it is pressed.
13. **START / EIGHT FIVE FIVE.** Touch this pad to start all entries. If no other settings have been made, touch this pad to cook at 100% power for 30 seconds. Press again to add time in 30 second increments, up to 9 minutes and 59 seconds. Cooking will start immediately.
14. **AUTO PIZZA.** Touch this pad to automatically bake fresh or frozen pizza.
15. **BAKE.** Touch this pad to select a temperature to bake selected food items.

UNDERSTANDING YOUR MICROWAVE OVEN

COOKWARE GUIDE

Most heat-resistant, nonmetallic cookware is safe for use in your microwave oven.

However, to test cookware before using, follow these steps:

1. Place the empty cookware in the microwave oven.
2. Measure 1 cup (250 ml) of water in a glass measuring cup and place it in the oven beside the cookware.
3. Microwave on 100% power for 1 minute. If the dish is warm, it **should not** be used for microwave cooking.

USE

Ovenproof Glass

- Glass treated for use in high-intensity heat includes utility dishes, bread dishes, pie plates, cake plates, liquid measuring cups, casseroles, and bowls without metallic trim.

China

- Bowls, cups, serving plates, and platters without metallic trim can be used in your oven.

Plastic

- When using plastic wrap as a cover, make sure that the dish is deep enough so the plastic wrap does not touch the food. As the food heats, it may melt the plastic wrap wherever the wrap touches the food.
- Place plastic wrap loosely over the top of the dish and secure it by pressing the wrap to the sides of the dish.
- Vent by turning back one corner of the plasticwrap. This will allow excess steam to escape.
- Use plastic dishes, cups, semi-rigid freezer containers, and plastic bags **only for short time cooking. Use these with care because the plastic may soften from the heat of the food.**

Paper

- Microwave-safe paper towels, waxed paper, paper napkins, and paper plates with no metallic trim or design can be used in your oven.
- Refer to the manufacturer's label for use of any paper product in the microwave oven.

DO NOT USE

Metal Utensils

- Metal shields food from microwave energy and produces uneven cooking. Avoid metal skewers, thermometers, or foil trays.
- Metal utensils can cause arcing, which is a discharge of electric current. Arcing can damage your microwave oven.

Metal Decoration

- Do not use metal-trimmed or metal-banded dinnerware, casserole dishes, etc.

Centura™ Tableware

- The Corning Company recommends that you do not use Centura tableware and some Corelle™ closed-handle cups for microwave cooking.

Aluminum Foil

- Do not use large sheets of aluminum foil because they hinder cooking and may cause arcing. You may use small pieces of foil to shield poultry legs and wings.
- Keep all aluminum foil at least 1 inch from the walls and door of the oven.

Wood

- Wooden bowls, boards, and baskets will dry out and may split or crack when you use them in the microwave oven.

Tightly Closed Containers

- Tightly closed cookware can explode. Be sure to leave an opening for steam to escape from covered cookware.

Brown Paper

- **Do not use brown paper bags.** They absorb heat and could burn.

Metal Twist Ties

- Always remove metal twist ties as they can become hot and cause a fire.

UNDERSTANDING YOUR MICROWAVE OVEN

TIPS FOR MICROWAVE COOKING

BROWNING

Meat and poultry with high fat content that are cooked for 10 or 15 minutes or longer will brown lightly. Foods cooked a shorter time can be brushed with a browning agent, such as Worcestershire sauce, soy sauce, or barbecue sauce.

COVERING

A cover traps heat and steam and causes the food to cook more quickly. Use a lid or microwave-safe plastic wrap with one corner folded back to vent the excess steam. Lids on glass casseroles can become hot during cooking. Handle carefully. Waxed paper will prevent the food from splattering in the oven and help retain heat. When warming bread items, use waxed paper, napkins, or paper towels. To absorb extra moisture, wrap sandwiches and fatty foods in paper towels.

SPACING

Arrange individual foods, such as baked potatoes, cupcakes, and hors d'oeuvres in a circle and at least 1 inch apart. This will help the food cook more evenly.

STIRRING

Stirring blends flavors and redistributes the heat in foods. Always stir from the outside toward the center of the dish. Food at the outside of the dish heats first.

TURNING

Large foods, such as roasts and whole poultry, should be turned so that the top and bottom cook evenly. Also turn over chicken pieces and chops.

CLEANING

Wipe the oven inside and outside with a soft cloth and a mild detergent solution, then rinse and wipe dry. This should be done weekly or more often, if needed. Never use cleaning powders or rough pads. Excessive oil splatters on the inside top will be difficult to remove if left for many days. Wipe splatters with a wet paper towel, especially after cooking chicken or bacon.

TURNTABLE

The turntable and turntable roller rest are removable. They should be hand-washed in warm (not hot) water with a mild detergent and a soft cloth. Once they are clean, rinse well and dry with a soft cloth. Never use cleaning powders, steel wool, or rough pads.

- The glass turntable may be cleaned in the sink. Be careful not to chip or scratch the edges as this may cause the turntable to break during use.
- The turntable roller rest should be cleaned regularly.

ARRANGEMENT

Do not stack food. Arrange in a single layer in the dish for more even cooking. Because dense foods cook more slowly, place thicker portions of meat, poultry, fish, and vegetables toward the outside of the dish.

TESTING FOR DONENESS

Because foods cook quickly in a microwave oven, you need to test frequently for doneness.

STANDING TIME IN OVEN

Depending on density, food often needs to stand from 2 to 15 minutes either in or outside the oven after cooking power shuts off. Outside of oven, you usually need to cover food during standing time to retain heat. Remove most foods when they are slightly undercooked and they will finish cooking during standing time. The internal temperature of food will rise about 10°F during standing time.

SHIELDING

To prevent some portions of foods in rectangular or square dishes from overcooking, you may need to shield them with small strips of aluminum foil to block the microwaves. You can also cover poultry legs and wing tips with foil to keep them from overcooking. Always keep foil at least 1 inch from oven walls to prevent arcing.

PIERCING

Pierce the shell, skin, or membrane of foods before cooking to prevent them from bursting. Foods that require piercing include yolks and whites of eggs, hot dogs, clams, oysters, and whole vegetables, such as potatoes and squash.

PIZZA OVEN PAN

The pizza grill pan features a non-stick surface and is dishwasher safe. It should be washed regularly in a dishwasher or warm, soapy water.

SPECIAL CARE

For best performance and safety, the inner door panel and the oven front frame should be free of food or grease buildup. Wipe often with a mild detergent, then rinse and wipe dry. Never use cleaning powders or rough pads.







After cleaning the control panel, touch STOP/PRESS TO CANCEL to clear any entries that might have been entered accidentally while cleaning the panel.

USING YOUR MICROWAVE OVEN

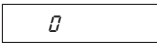
CLOCK

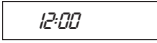
When the oven is first plugged into a power outlet, please set the clock.

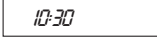
Example: To set the clock for 10:30.

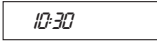





- | Touch: | Display Shows: |
|---|---|
| 1.  |  |
| 2.  |  |
| 3. 10 30
  |  |
| 4.  |  |

NOTE: This is a 12-hour clock.

KITCHEN TIMER

Your microwave can be used as a kitchen timer. You can set up to 99 minutes and 99 seconds.



Example: To set the kitchen timer for 3 minutes.

- | Touch: | Display Shows: |
|--|---|
| 1.  |  |
| 2. 3 00
  |  |
| 3.  | 
Time counts down to 0. |

CHILD LOCK

Use this safety feature to lock the control panel when you are cleaning the oven, or to prevent children from using the oven unsupervised.

To set Child Lock.

- | Touch: | Display Shows: |
|---|---|
| 1.  | Time of day |
| 2. 0
 |  |
- Touch and hold until "L" appears (approximately 4 seconds).



To cancel CHILD LOCK.

- | Touch: | Display Shows: |
|---|----------------|
| 1. 0
 | Time of day |
- Touch and hold until "L" disappears (approximately 4 seconds).

ADD 30 SECONDS

A time-saving pad, this simplified control lets you quickly set and start microwave cooking at 100% power without the need to set the time and press START.

Example: To cook for 1 minute.

- | Touch: | Display Shows: |
|---|--|
| 1.  | Time of day |
| 2.  Twice. | Time counting down and power level 10. |

NOTE: If you touch ADD 30 seconds, it will add 30 seconds each time the pad is pressed, up to 9 minutes and 59 seconds.

USING YOUR MICROWAVE OVEN

MORE & LESS FUNCTIONS

This convenient feature lets you add or reduce cooking time in 10 second increments while a cooking cycle is in process without having to restart the cooking cycle.

Example: When cooking is in process with 2 minutes remaining, you want to add 20 seconds.

Touch:

Display Shows:

2:00

1. + Touch two times.

2:20

Time counting down

NOTE: Use the LESS pad to decrease the cooking time in 10 second increments.

TIMED COOKING

This feature lets you program a specific cook time and power level. For best results, there are 10 power level settings in addition to HIGH (100%) power. Refer to the "Microwave Power Levels Table" on page 12 for more information.

NOTE: If you do not select a power level, the oven will automatically cook at 100% power.

Example: Timed Cooking for 2 minutes.

Touch:

Display Shows:

1. Cook Time

:0

2. 5 3 0
⏏

5:30

3. Power

PL 10

4. 8

PL 8

5.  START
Q-START

5:30

Time counting down

MULTISTAGE COOKING

For best results, some recipes call for different cooking power levels during different stages of a cook cycle. You can program your oven to switch from one power level to another for up to 3 stages.

Example: To set a 2-stage cook cycle.

Touch:

Display Shows:

1. Cook Time

:0

2. 3 0 0
⏏ ⏏ to set a 3-minute cook time for the first stage.

3:00

3. Power

PL 10

4. 8 to set an 80% cook power for the first stage.

PL 8

5. Cook Time

:0

6. 7 0 0
⏏ ⏏ to set a 7-minute cook time for the second stage.

7:00

7. Power

PL 10

8. 5 to set a 50% cook power for the second stage.

PL 5

9.  START
Q-START

3:00

10. When the first stage is over, you will hear two short tones as the oven begins the second cook stage.

USING YOUR MICROWAVE OVEN

MICROWAVE POWER LEVELS

Your microwave oven has 10 cook power levels to allow you to cook or heat a wide variety of foods. Refer to the table below for suggestions:

Microwave Power Level Table



Power Level	Use
10 (High)	<ul style="list-style-type: none">• Boiling water.• Making candy.• Cooking poultry pieces, fish, and vegetables.• Cooking tender cuts of meat.• Whole poultry.
9	<ul style="list-style-type: none">• Reheating rice, pasta, and vegetables.
8	<ul style="list-style-type: none">• Reheating prepared foods quickly.• Reheating sandwiches.
7	<ul style="list-style-type: none">• Cooking egg, milk, and cheese dishes.• Cooking cakes, breads.• Melting chocolate.
6	<ul style="list-style-type: none">• Cooking veal.• Cooking whole fish.• Cooking puddings and custard.
5	<ul style="list-style-type: none">• Cooking ham, whole poultry, and lamb.• Cooking rib roast, sirloin tip.
4	<ul style="list-style-type: none">• Thawing meat, poultry, and seafood.
3	<ul style="list-style-type: none">• Cooking less tender cuts of meat.• Cooking pork chops, roast.
2	<ul style="list-style-type: none">• Taking chill out of fruit.• Softening butter.
1	<ul style="list-style-type: none">• Keeping casseroles and main dishes warm.• Cream cheese.
0	<ul style="list-style-type: none">• Standing time.

USING YOUR MICROWAVE OVEN



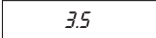

QUICK TOUCH COOKING

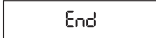
Use this function to cook food without entering a cook time or power level. Refer to the Quick Touch Cook Table below for more information.

Example: To cook a 3.5 oz. bag of microwave popcorn.

- | Touch: | Display Shows: |
|--|---|
| 1.  |  |
| 2.  | Time counting down |
| 3. At the end of cooking time, 2 short tones and 1 long tone will sound. |  |

Example: To cook 1 potato.

- | Touch: | Display Shows: |
|--|---|
| 1.  |  |
| 2.  | Time counting down |
| 3. At the end of cooking time, 2 short tones and 1 long tone will sound. |  |

CATEGORY	TOUCH	SERVING SIZE	DIRECTIONS
Popcorn	1 time 2 times	3.5 oz. 3.0 oz.	<ul style="list-style-type: none"> Follow package instructions. Do not try to pop unpopped kernels. Heat only 1 package at a time.
Potato	1 time 2 times 3 times 4 times	1 ea. (8 oz.) 2 ea. (16 oz.) 3 ea. (24 oz.) 4 ea. (32 oz.)	<ul style="list-style-type: none"> 8-10 oz. per potato Place in center of the turntable on paper towel. Pierce potato several times with fork. After cooking, let stand for 5 minutes.

USING YOUR MICROWAVE OVEN

REHEAT

Reheat provides four preset categories for reheating food.

Example: To reheat 2 food plate servings.

Touch:

Display Shows:

1. 

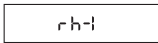

Refer to the cooking guide to select the food type.

Category	Touch Pad	Display Shows
Food plate	1 Time	r h-1
Soup/Sauce	2 Times	r h-2
Casserole	3 Times	r h-3
Roll/Muffin	4 Times	r h-4

REHEAT (continued)

Example: To reheat 2 food plate servings.

Touch:

Display Shows:

2. 2

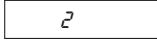

Refer to the cooking guide to select the food quantity.

Category	Number of cups/items
Food plate	1-2 servings
Soup/Sauce	1-4 cups
Casserole	1-4 cups
Roll/Muffin	1-4 pieces

3. 

Time counting down

4. At the end of cooking time, 2 short tones and 1 long tone will sound.

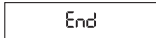

PRESS REHEAT	CATEGORY	SERVING AMOUNT	DIRECTIONS
1 Time	Food Plate r h-1	1 serving (10 oz.) 2 servings (15 oz.)	<ul style="list-style-type: none"> Place on low plate. Cover with vented plastic wrap. Let stand 3 minutes after cooking.
2 Time	Soup/Sauce r h-2	1 cup 2 cups 3 cups 4 cups	<ul style="list-style-type: none"> Place in shallow microwaveable casserole. Cover with vented plastic wrap. After cooking, stir and let stand 3 minutes.
3 Times	Casserole r h-3	1 cup 2 cups 3 cups 4 cups	<ul style="list-style-type: none"> Place in shallow microwaveable casserole. Cover with vented plastic wrap. After cooking, stir and let stand 3 minutes.
4 Times	Roll/Muffin r h-4	1 piece (2 oz.) 2 pieces (4 oz.) 3 pieces (6 oz.) 4 pieces (8 oz.)	<ul style="list-style-type: none"> Place on paper towel. Do not cover.

USING YOUR MICROWAVE OVEN





AUTO DEFROST

Three defrost sequences are preset in the oven. The defrost feature provides you with the best defrosting method for frozen foods. The cooking guide will show you which defrost sequence is recommended for the food you are defrosting.

For added convenience, the AUTO DEFROST includes a built-in beep mechanism that reminds you to check, turn over, separate, or rearrange the food during the defrost cycle. Three different defrosting options are provided.

1. MEAT
2. POULTRY
3. FISH

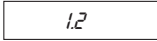
* Available weight is 0.1–6.0 lbs. (.05 to 2.7 kg).

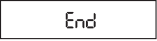
Example: To defrost 1.2 lbs. of ground beef.	
Touch:	Display Shows:
1. 	
2. 1 and 2 to enter the weight.	
3. 	Time counting down
4. At the end of cooking time, 2 short tones and 1 long tone will sound.	

EQUIVALENT WEIGHT TABLE

Ounces	Decimal Weight
1.6	.10
3.2	.20
4.0	.25 – One-quarter pound
4.8	.30
6.4	.40
8.0	.50 – One-half pound
9.6	.60
11.2	.70
12.0	.75 – Three-quarters pound
12.8	.80
14.4	.90
16.0	1.00

NOTE:

When you touch the START/ADD 30 pad, the display changes to defrost time countdown. The oven will beep during the DEFROST cycle. At this time, open the door and turn, separate, or rearrange the food.

Remove any portions that have thawed. Return frozen portions to the oven and touch START/ADD 30 to resume the defrost cycle. **The oven will not stop during the BEEP unless the door is opened.**

For best results:

- Remove fish, shellfish, meat, and poultry from its original closed paper or plastic package (wrapper). Otherwise, the wrapper will hold steam and juice close to the foods, which can cause the outer surface of the foods to cook.
- Form the meat into the shape of a doughnut before freezing. When defrosting, scrape off thawed meat when the beep sounds and continue defrosting.
- Place foods in a shallow glass baking dish or on a microwave roasting rack to catch drippings.
- Foods should still be somewhat icy in the center when removed from the oven.

AUTO DEFROST TABLE

Category	Food
<i>DEF 1</i> MEAT	BEEF Ground beef, round steak, cubes for stew, tenderloin steak, pot roast, rib roast, rump roast, chuck roast, hamburger patty
	LAMB Chops (1-in. [2.5-cm] thick), rolled roast
	PORK Chops (1/2-in. [1-cm] thick), hot dogs, spareribs, country-style ribs, rolled roast, sausage
<i>DEF 2</i> POULTRY	VEAL Cutlets (1 lb. [0.5 kg], 1/2-in. [1-cm] thick).
	POULTRY Whole (under 4 lbs. [1.8 kg]), pieces, breasts (boneless)
	CORNISH HENS Whole TURKEY Breast (under 6 lbs. [2.7 kg])
<i>DEF 3</i> FISH	FISH Filets, whole steaks
	SHELLFISH Crab meat, lobster tails, shrimp, scallops

USING YOUR MICROWAVE OVEN

WARNING: Do not use large sheets of aluminum foil because they hinder cooking and may cause arcing. You may use small pieces of foil to shield poultry legs and wings. Keep all aluminum foil at least 1 inch from the walls and door of the oven.

COOKING TIPS

Meat

1. No special techniques are required. Meat should be prepared as with conventional cooking. Season if desired. Always thoroughly defrost meat before cooking.
2. Place the meat on a microwave roasting rack or microwave-proof plate and place on the turntable.
3. Cook according to the Meat Cooking Table (below). Use the longer time for large cuts of meats and the shorter time for small cuts of meats. For thicker chops, use the longer time.
4. Turn the meat once halfway through the cooking time.
5. Let stand for 5-10 minutes wrapped in foil after cooking. The standing time is very important as it completes the cooking process.
6. Make sure meat, especially pork, is thoroughly cooked before eating.

Meat	Microwave Power	Cooking Time Per Pound
BEEF Standing/Rolled Rib – Medium – Well-Done Ground Beef (to brown for casserole) Hamburgers, fresh or defrosted (4 oz. each) – 2 patties – 4 patties	8 8 HIGH (100%) HIGH (100%) HIGH (100%)	8 to 10 minutes 8 to 10 minutes 5½ to 8½ minutes 2 to 4 minutes 3 to 5 minutes
PORK Loin, Leg Bacon – 4 slices – 6 slices	8 HIGH (100%) HIGH (100%)	12 to 16 minutes 2 to 3 minutes 3 to 4 minutes

NOTE: The times listed above are only a guide. Allow for differences in individual tastes and preferences. The times may also vary due to the shape, cut, and composition of the food.

Poultry

1. No special techniques are required. Poultry should be prepared as with conventional cooking. Season if desired.
2. Poultry should be thoroughly defrosted. Remove giblets and any metal clamps.
3. Prick the skin and brush lightly with vegetable oil unless the poultry is self-basting.
4. All poultry should be placed on a microwave roasting rack or a microwave-proof plate and placed on the turntable.
5. Cook according to the instructions in the Poultry Cooking Table below. Turn over halfway through the cooking time. Because of its shape, poultry has a tendency to cook unevenly, especially in very bony parts. Turning food over helps to cook these areas evenly.
6. Remove from oven, wrap in foil, and let stand for 5–10 minutes before carving. The standing time is very important, since it completes the cooking process.
7. Make sure poultry is thoroughly cooked before eating. Whole poultry is completely cooked when the juices run clear from the inside thigh when it is pierced with a sharp knife. Poultry pieces should be pierced with a sharp knife through the thickest part to ensure that the juices are clear and the flesh is firm.

Poultry	Microwave Power	Cooking Time Per Pound
CHICKEN Whole Breast (boned) Portions	8 8 8	10 to 14 minutes 9 to 13 minutes 10 to 16 minutes
TURKEY Whole	8	10 to 14 minutes

NOTES:

- The times listed above are only a guide. Allow for differences in individual tastes and preferences. The times may also vary due to the shape, cut, and composition of the food.
- If whole poultry is stuffed, the weight of the stuffed bird should be used when calculating the cooking time.

USING YOUR MICROWAVE OVEN

COOKING TIPS (continued)

Fish

1. Arrange fresh or frozen fish in a large shallow non-metallic dish or casserole.
2. Cover with pierced microwave plastic wrap or casserole lid.
3. Place the dish on the turntable.
4. Cook according to the instructions in the Fish Cooking Table below. Flakes of butter can be added to the fish, if desired.
5. Let stand as directed in the Cooking Table before serving.
6. After standing time, check to see that the fish is thoroughly cooked. The fish should be opaque and flake easily.

FISH	Microwave Power	Cooking Time Per Pound	Butter	Standing Time
Fish Filets	HIGH	4 to 7 minutes	Add 1 to 2 tbsp (15 to 30 ml) lemon juice	2 to 3 minutes
Whole Mackerel, cleaned and prepared	HIGH	4 to 7 minutes	—	3 to 4 minutes
Whole Trout, cleaned and prepared	HIGH	5 to 8 minutes	—	3 to 4 minutes
Salmon Steaks	HIGH	6 to 7 minutes	Add 1 to 2 tbsp (15 to 30 ml) lemon juice	3 to 4 minutes

USING THE PIZZA OVEN

COOKING WITH AUTO PIZZA

Four pizza bake functions are preset in the oven. The AUTO PIZZA feature automatically selects the best cooking method and time for various pizza types. The cooking guide shows which AUTO PIZZA function is recommended for the the pizza you are cooking.

Example: To cook a frozen regular crust pizza.

Touch:

1.  Twice.

2. 

3. At the end of cooking time, 2 short tones and 1 long tone will sound.

Display Shows:

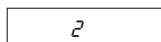
 2

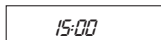
 15:00

Red indicator light will come on and time counting down.

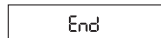
 End

Press AUTO PIZZA	Pizza Type	Cooking Time
1 time	Frozen rising crust pizza	21 minutes
2 times	Frozen regular crust pizza	15 minutes
3 times	Fresh regular crust pizza	15 minutes
4 times	Fresh par-baked crust pizza	25 minutes
+	Touch this pad to add 10 seconds of cooking time each time it is pressed.	
-	Touch this pad to subtract 10 seconds of cooking time each time it is pressed.	

NOTE: ALWAYS use the pizza tray when cooking in the pizza oven. Take care when removing food; the tray will be hot!

USING THE PIZZA OVEN







COOKING WITH THE BAKE FEATURE

Four BAKE temperatures are preset in the oven. The BAKE temperature feature provides you with easy programming to bake selected food items.

CAUTION: DO NOT USE THIS OVEN FOR BROILING FOODS. This oven is not intended for broiling.

Oven temperatures may vary. Adjust oven temperatures and baking times as necessary.

Example: To bake at 400° F for 12 minutes.

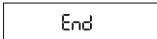
- | Touch: | Display Shows: |
|---|--|
| 1.  Twice. |  |
| 2. 12 0 0   To enter cook time. |  |
| 3.  | Red indicator light will come on and time counting down. |
| 4. At the end of cooking time, 2 short tones and 1 long tone will sound. |  |

NOTE: ALWAYS use the pizza tray when cooking in the pizza oven. Take care when removing food; the tray will be hot!

Press BAKE	BAKE temperature	Recommended food
1 time	425° F (218° C)	Frozen potatoes
2 times	400° F (204° C)	Frozen foods
3 times	375° F (190° C)	Cookies
4 times	350° F (176° C)	Biscuits

TROUBLESHOOTING

Questions and Answers

Operation

Question	Answer
Why is the oven light not on during cooking?	There may be several causes. Have you: <ul style="list-style-type: none"> • Set a cooking time? • Pressed the START pad?
Why is the clock display blank or off?	Make sure the microwave oven is plugged into a working outlet. Check for a blown house fuse or tripped circuit breaker.
Why does steam come out of the air exhaust vent?	Steam is normally produced during cooking. The microwave oven has been designed to vent this steam.
Will the microwave oven be damaged if it operates empty?	Yes. Never operate the oven empty or without the glass turntable.
Does microwave energy pass through the viewing screen in the door?	No. The metal screen bounces the energy back to the oven cavity. The holes (or ports) allow only light to pass through. They do not let microwave energy pass through.
Why does a tone sound when a pad on the control panel is touched?	The tone tells you that the setting has been entered.
Can the microwave oven be damaged if food is cooked for too long?	Like any other cooking appliance, it is possible to overcook food to the point that the food creates smoke and even possibly fire and damage to the inside of the oven. It is always best to be near the oven while you are cooking.
When the oven is plugged into the wall outlet for the first time, it doesn't work properly. What is wrong?	The microcomputer controlling your oven may temporarily become scrambled and fail to function as programmed when you plug it in for the first time or when power resumes after a power interruption. Unplug the oven from the 120-volt household outlet and then plug it back in to reset the microcomputer and then reset the clock.
Why is there light reflection around the outer case?	This light is from the oven light which is located between the oven cavity and the outer wall of the oven.
What are the various sounds heard when the microwave oven is operating?	The clicking sound is caused by a mechanical switch turning the microwave oven's magnetron ON and OFF. The heavy hum is from the change in power the magnetron draws as it is turned ON and OFF by a mechanical switch. The change in blower speed is from the change in line voltage caused by the magnetron being turned ON and OFF.
Why is there a fan running after the pizza oven is stopped?	The fan will continue operating to cool the internal components of the pizza oven.

TROUBLESHOOTING

Questions and Answers (continued)

Food

Question	Answer
What is wrong when baked foods have a hard, dry, brown spot?	A hard, dry, brown spot indicates overcooking. Shorten the cooking or reheating time.
Why do eggs sometimes pop?	When baking, frying, or poaching eggs, the yolk may pop due to steam buildup inside the yolk membrane. To prevent this, simply pierce the yolk with a wooden toothpick before cooking. CAUTION: Never microwave eggs in the shell.
Why are scrambled eggs sometimes a little dry after cooking?	Eggs will dry out when they are overcooked, even if the same recipe is used each time. The cooking time may need to be varied for one of these reasons: <ul style="list-style-type: none"> • Eggs vary in size. • Eggs are at room temperature one time and at refrigerator temperature another time. • Eggs continue cooking during standing time.
Why do baked apples sometimes burst during cooking?	The peel has not been removed from the top half of each apple to allow for expansion of the interior of the apple during cooking. As in conventional cooking methods, the interior of the apple expands during the cooking process.
Why do baked potatoes sometimes burn during cooking?	If the cooking time is too long, fire could result. At the end of the recommended cooking time, potatoes should be slightly firm. CAUTION: Do not overcook.
Why is a standing time recommended after microwave cooking time is over?	Standing time allows foods to continue cooking evenly for a few minutes after the actual microwave oven cooking cycle ends. The amount of standing time depends upon the density of the foods.
Why is additional time required for cooking food stored in the refrigerator?	As in conventional cooking, the initial temperature of food affects total cooking time. You need more time to cook food taken out of a refrigerator than for food at room temperature.
Why is pizza underdone or burnt?	You may need to adjust the cooking time and temperature.
Why does the pizza pan get hot?	The pizza pan is used to retain heat and help brown the food.
Can I use the pizza oven to broil foods?	No. The oven is to be used for baking select food items and pizzas only.
Can I cook without the pizza pan?	No. The pan must be used for any baking done in the oven.

TROUBLESHOOTING

BEFORE CALLING FOR SERVICE

You can often correct operating problems yourself. If your microwave oven fails to work properly, locate the operating problem in the list below and try the solutions listed for each problem.

If the microwave oven still does not work properly, contact the nearest Sears Parts & Repair Center, which is fully equipped to handle your service requirements. See warranty on page 2.

Problem	Possible Causes
Oven does not start	<ul style="list-style-type: none"> • Is the power cord plugged in? • Is the door closed? • Is the cooking time set? • Has the house circuit breaker tripped or blown?
Arcing or sparking	<ul style="list-style-type: none"> • Are you using approved cookware? • Is the oven empty?
Incorrect time of day	<ul style="list-style-type: none"> • Have you tried to reset the time of day?
Unevenly cooked foods	<ul style="list-style-type: none"> • Are you using approved cookware? • Is the glass turntable in the oven? • Did you turn or stir the food while it was cooking? • Were the foods completely defrosted? • Was the time/cooking power level correct?
Overcooked foods	<ul style="list-style-type: none"> • Was the time/cooking power level correct?
Undercooked foods	<ul style="list-style-type: none"> • Are you using approved cookware? • Were the foods completely defrosted? • Was the time/cooking power level correct? • Are the ventilation ports clear?
Improper defrosting	<ul style="list-style-type: none"> • Are you using recommended cookware? • Was the time/cooking power level correct? • Did you turn or stir the food during the defrosting cycle?

FEDERAL COMMUNICATIONS COMMISSION RADIO FREQUENCY INTERFERENCE STATEMENT (U.S.A. ONLY)

WARNING:

This equipment generates and uses ISM frequency energy and if not installed and used properly, that is in strict accordance with the manufacturer's instructions, may cause interference to radio and television reception. It has been type-tested and found to comply with limits for ISM Equipment pursuant to part 18 of FCC Rules, which are designed to provide reasonable protection against such interference in a residential installation.

However, there is no guarantee that interference will not occur in a particular installation. If this equipment does cause interference to radio or television reception, which can be determined by turning the equipment off and on, the user is encouraged to try to correct the interference by one or more of the following:

- Reorient the receiving antenna of the radio or television.
- Relocate the microwave oven with respect to the receiver.
- Move the microwave oven away from the receiver.
- Plug the microwave oven into a different outlet so that the microwave oven and the receiver are on different branch circuits.

The manufacturer is not responsible for any radio or TV interference caused by **unauthorized modification** to this microwave oven. It is the responsibility of the user to correct such interference.



LG MICROWAVE OVEN LIMITED WARRANTY – USA

Model LCSP1110ST

LG Electronics, Inc. will repair or replace your product, at LG's option, if it proves to be defective in material or workmanship under normal use, during the warranty period set forth below, effective from the date of original consumer purchase of the product. This warranty is good only to the original purchaser of the product and effective only when used in the United States, including U.S. Territories.

<u>WARRANTY PERIOD:</u>	<u>HOW SERVICE IS HANDLED:</u>
<p>LABOR: Two Years from the Date of Purchase*.</p> <p>PARTS (<u>except as listed below</u>): Two Years from the Date of Purchase*.</p> <p>MAGNETRON: Ten Years from the Date of Purchase*.</p> <p>Replacement Units and Repair Parts are warranted for the remaining portion of the original unit's warranty period.</p> <p>* Retain your Sales Receipt to prove the date of purchase. A copy of your Sales Receipt must be submitted at the time warranty service is provided.</p>	<p>Please call 1-800-243-0000 and choose the appropriate option. (Phones are answered 24 hours a day, 365 days per year.) Please have the product type (Microwave) and your ZIP code ready.</p> <p>Or visit our website at: http://us.lgservice.com</p>

THIS WARRANTY IS IN LIEU OF ANY OTHER WARRANTY, EXPRESS OR IMPLIED, INCLUDING WITHOUT LIMITATION, ANY WARRANTY OF MERCHANTABILITY OR FITNESS FOR A PARTICULAR PURPOSE. TO THE EXTENT ANY IMPLIED WARRANTY IS REQUIRED BY LAW, IT IS LIMITED IN DURATION TO THE EXPRESS WARRANTY PERIOD ABOVE. LG WILL NOT BE LIABLE FOR ANY INCIDENTAL, CONSEQUENTIAL, INDIRECT, SPECIAL, OR PUNITIVE DAMAGES OF ANY NATURE, INCLUDING WITHOUT LIMITATION, LOST REVENUES OR PROFITS, OR ANY OTHER DAMAGE WHETHER BASED IN CONTRACT, TORT, OR OTHERWISE. Some states do not allow the exclusion or limitation of incidental or consequential damages or limitations on how long an implied warranty lasts, so the above exclusion or limitation may not apply to you. This warranty gives you specific legal rights and you may also have other rights that vary from state to state.

THIS LIMITED WARRANTY DOES NOT APPLY TO:

- Service trips to your home to deliver, pick up, and/or install the product, instruct, or replace house fuses or correct wiring, or correction of unauthorized repairs.
- Damages or operating problems that result from misuse, abuse, operation outside environmental specifications or contrary to the requirements of precautions in the Operating Guide, accident, vermin, fire, flood, improper installation, acts of God, unauthorized modification or alteration, incorrect electrical current or voltage, or commercial use, or use for other than intended purpose.

The cost of repair or replacement under these excluded circumstances shall be borne by the consumer

CUSTOMER INTERACTIVE CENTER NUMBERS

To obtain Customer Assistance, Product Information, or Dealer or Authorized Service Center location :	Call 1-800-243-0000 (24 hours a day, 365 days per year) and select the appropriate option from the menu. Or visit our website at: http://us.lgservice.com
---	--

TO CONTACT LG ELECTRONICS BY MAIL:

LG Customer Interactive Center
P. O. Box 240007
201 James Record Road
Huntsville, Alabama 35824
ATTN: CIC

