

BAYOU CLASSIC®

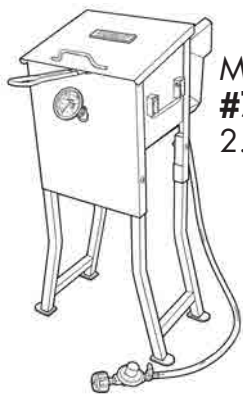

MODEL
#700-725
2.5-Gallon



MODEL
#700-701
4-Gallon

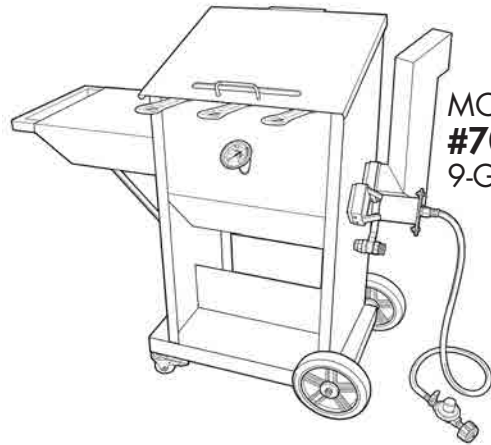

MODEL
#700-709
9-Gallon

STAINLESS BAYOU® FRYER OWNER'S MANUAL

Safety Alerts, Assembly & Operating Instructions
General Maintenance & Storage

This Instruction Manual contains important information necessary for the proper assembly and safe use of this appliance. Carefully read and follow all warnings and instructions before assembling and using this appliance.

KEEP THIS MANUAL FOR FUTURE REFERENCE

⚠ WARNING

- This appliance does not have automatic thermostat controls so must be attended and monitored at all times during oil heat up and frying.
- Oil heated above 400°F can ignite and cause a fire.
- Monitor the thermometer every 3 minutes to ensure cooking oil does not exceed 400°F.
- Shut off gas if oil exceeds 400°F or begins to smoke.
- Lid must be open during oil heat up and frying.
- In case of fire; close lid, turn off gas and call Fire Department.
- Do not attempt to extinguish an oil/grease fire with water.
- Surface of the appliance is extremely hot.
- This appliance is not to be used to fry whole turkeys.

NOT FOR COMMERCIAL USE

For Questions and Information call us at: **1-800-864-6194** • Monday - Friday 8:00am - 5:00pm CST
Barbour International, Inc. • 101 Cypress Way • Brandon, MS 39042 • www.thebayou.com

The warnings and safety instructions in this manual **MUST** be understood and followed to provide reasonable safety and efficiency while using your appliance. Read the assembly, operation, and storage instructions thoroughly before operating or servicing this equipment.

FAILURE TO FOLLOW THESE INSTRUCTIONS COULD RESULT IN FIRE, EXPLOSION OR BURN HAZARD, WHICH COULD CAUSE PROPERTY DAMAGE, PERSONAL INJURY OR DEATH.

⚠ WARNING ⚠

- This fryer is a high pressure gas appliance for **OUTDOOR USE ONLY** (Outside any enclosure). **DO NOT** use in a building, home, garage, balcony, porch, tent or any other enclosed area. Gas appliances shall not be used on or under apartment/condominium balconies or decks. **DO NOT** install or use in or on recreational vehicles, pick-up trucks or boats.
- This appliance does not have automatic thermostat controls and **MUST BE ATTENDED** and monitored at all times during oil heat up, frying, and cool down periods.
- Only use replacement/accessory parts manufactured by Barbour International, Inc.
- Combustion by products from the use of this product can contain chemicals known to the State of California to cause cancer, birth defects, or other reproductive harm.
- This product contains a chemical(s) known to the State of California to cause cancer, birth defects or other reproductive harm.
- **THIS APPLIANCE IS NOT TO BE USED TO FRY WHOLE TURKEYS.**

Remember: Think Safety and Use Common Sense!

⚠ DANGER ⚠

IF YOU SMELL GAS:

1. Shut off gas to the appliance.
2. Extinguish any open flame.
3. If odor continues, keep away from the appliance and immediately call your fire department.

⚠ DANGER ⚠

- **Sober adult operation ONLY!** Only a qualified person shall operate this appliance. The use of alcohol, prescription or non prescription drugs may impair ability to properly assemble or safely operate this appliance.
- Do not use this fryer for other than its intended purpose.
- Never allow oil or grease to exceed 400°F (200°C), it can ignite and cause a fire. Shut off gas if oil exceeds 400°F or begins to smoke.
- Regardless of thermometer reading, if the oil/grease starts to smoke, turn **OFF** fuel supply to the burner and **STOP COOKING IMMEDIATELY**. This indicates the thermometer is not working properly. Discard the thermometer and call 1-800-864-6194 M-F 8am-5pm CST for assistance.
- Never operate this appliance within 10 feet of any structure or combustible material. Do not operate it within 25 feet of combustible/flammable liquids such as gasoline or paints.
- In case of fire, close lid, turn off gas and call Fire Department.
- Do not attempt to extinguish an oil/grease fire with water.

CONTENTS

| | | | |
|------------------------------------|-------|--------------------------------------|---------|
| Table of Contents/Safety Symbols | 1 | Liquid Propane Gas Information | 10 - 11 |
| Safety Precautions & Warnings | 2 | Gas Leak Testing Instructions | 12 - 13 |
| Note to Consumer & Warranty | 3 | Set-Up and Positioning | 14 |
| Assembly Instructions | | Set-Up for 2.5 Gallon Tabletop Fryer | 15 |
| #700-725 2.5-Gal. | 4 | Lighting Instructions | 16 |
| #700-709 9-Gal. | 5 | Operating Instructions | 17 |
| #700-701 4-Gal. | 6 - 7 | Cooking Oil | 18 - 19 |
| Thermometer Assembly | 8 | Cleaning and Storage | 20 |
| Regulator Hose Assembly | 8 | Trouble Shooting Tips | 21 |
| Connecting Regulator Hose Assembly | 9 | FAQs and Helpful Tips | 22 |

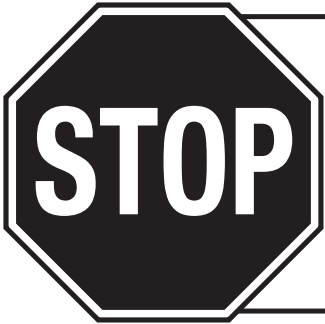

If you have a missing or damaged part, **please do not return** this item to the store.

Call **Barbour International, Inc.** for assistance:

1-800-864-6194



Monday-Friday 8:00am - 5:00pm CST



SAFETY SYMBOLS



The symbols and boxes shown below explain what each heading means. Read and follow all of the safety warnings and instructions contained in this manual and on the cooker.

THE PURPOSE OF THIS SAFETY ALERT SYMBOL  IS TO ATTRACT YOUR ATTENTION TO POSSIBLE HAZARDS AS YOU ASSEMBLE AND USE THIS PRODUCT.

WHEN YOU SEE THE SAFETY ALERT SYMBOL  PAY CLOSE ATTENTION TO THE INFORMATION WHICH FOLLOWS!

 DANGER  → Indicates an imminently hazardous situation which, if not avoided, will result in death or serious injury.

 WARNING  → Hazard or unsafe practices which could result in severe property damages, personal injury, or death.

 CAUTION  → Hazard or unsafe practices which could result in minor personal injury, product, or property damages.

Carefully read and follow all **WARNINGS, SAFETY PRECAUTIONS, ASSEMBLY and OPERATING INSTRUCTIONS** contained in this manual and on the cooker.

DO NOT skip any of the warnings and instructions! SAVE THIS MANUAL FOR FUTURE REFERENCE.

SAFETY PRECAUTIONS AND WARNINGS

! WARNING !

This fryer does not have automatic thermostat controls. Failure to follow these instructions could result in fire or explosion which could cause property damage, personal injury or death!



ALWAYS

operate in a clear open area away from buildings, trees and shrubs.



OUTDOOR USE ONLY!

Do not operate inside patios, garages or carports.



NEVER LEAVE APPLIANCE UNATTENDED!



NEVER

use under any roof or overhang.



NEVER

use on decks, boats or any combustible surface!



NEVER

place flammable or combustible materials within 25-ft of fryer.



NEVER

close lid when preheating oil or frying.



NEVER!

let children or pets near the cooking area **during** and **after** use.



NEVER!

No barefeet or sandals when cooking.



HOT!

Unit is extremely hot during and after use. Allow 2 hours for unit to cool down before touching. Below 115°F (45°C)



ALWAYS

wear protective mitts, gloves, and long sleeve clothing when cooking.



ALWAYS

use an accurate thermometer to monitor temperature when preheating oil or frying.

Remember: Think Safety and Use Common Sense!

NOTE TO CONSUMER

This LP Gas Cooker is a specialized high pressure gas appliance having greater heat output than traditional kitchen stoves. It operates using an open flame, and you must use extreme caution and attention when operating. It is referred to as "**fryer**" and "**appliance**" in this manual and on warning tags. Same as a kitchen stove, this appliance does not have automatic thermostat controls so must be attended and monitored at all times during use. Owning and operating this appliance includes accepting responsibility and liability for using it safely and properly according to all applicable laws, common sense practices, and all information found within the manual.

This appliance is for **OUTDOOR USE ONLY**, providing multiple cooking options such as frying fish, chicken, french fries, hushpuppies, onions and wings. **This appliance is not to be used to fry whole turkeys.**

Restrict the use of this appliance to sober adults who can read, understand and follow the warnings and instructions in this manual, and on the fryer. Safety Alerts alone cannot eliminate the hazards that they signal. Strict compliance with these instructions, plus common sense operation, are primary accident prevention measures.

If you have any doubts or concerns about your ability to use this appliance call 1-800-864-6194. If, after talking with a Bayou Classic Customer Service Representative, you still have concerns about operating this appliance, **DO NOT USE!** Contact your dealer for return and refund.

The assembly and operation of this appliance must conform with local codes or; in the absence of local codes, with the National Fuel Gas Code, ANSI Z223.1/NFPA 54, Storage and Handling of Liquefied Petroleum Gases, ANSI/NFPA 58, Natural Gas and Propane Installation Code, CSA B149.1, Propane Storage and Handling, CSA B149.2, or the Standard for Recreational Vehicles, ANSI A119.2/NFPA 1192 and the Recreational Vehicle Code, CSA z240 RV Series.

Where conflicts exist between instructions and information in this manual and local or national codes or regulations regarding use and operation of this appliance, the operator shall comply with the codes or laws put in force by the regulatory authority for the zone in which the equipment is operated. To check your local codes, see your local LP gas dealer or Natural Gas Company.

Sincerely,

The logo for Bayou Classic, featuring the brand name in a stylized, gothic-style font with a registered trademark symbol.

LIMITED WARRANTY

Barbour International, Inc. ("Vendor") warrants to the original retail purchaser of this gas fryer/cooker and no other person, that if this gas fryer/cooker is assembled and operated in accordance with the printed instructions accompanying it, then for a period of one (1) year from the date of purchase, all parts in such gas fryer/cooker shall be free from defects in material and workmanship. Vendor may require reasonable proof of your date of purchase from an authorized retailer or distributor. Therefore, you should retain your sales slip or invoice. This Limited Warranty shall be limited to the repair or replacement of parts, which prove defective under normal use and service and which Vendor shall determine in its reasonable discretion upon examination to be defective. Before returning any parts, you should contact Vendor's Customer Service Department using the contact information listed below. If Vendor confirms, after examination, a defect covered by this Limited Warranty in any returned part, and if Vendor approves the claim, Vendor will replace such defective part without charge. If you return defective parts, transportation charges must be prepaid by you. Vendor will return replacement parts to the original retail purchaser, freight or postage prepaid.

This Limited Warranty does not cover any failures or operating difficulties due to accident, abuse, misuse, alteration, misapplication, improper installation or improper maintenance or service by you or any third party, or failure to perform normal and routine maintenance on the gas fryer/cooker, as set out in this owner's manual. In addition, the Limited Warranty does not cover damage to the finish, such as scratches, surface chips and cracks, discoloration, rust or other weather damage, after purchase.

This Limited Warranty is in lieu of all other express warranties. Vendor disclaims all warranties for products that are purchased from sellers other than authorized retailers or distributors. AFTER THE PERIOD OF THE ONE (1)-YEAR EXPRESS WARRANTY, VENDOR DISCLAIMS ANY AND ALL IMPLIED WARRANTIES, INCLUDING WITHOUT LIMITATION THE IMPLIED WARRANTIES OF MERCHANTABILITY AND FITNESS FOR A PARTICULAR PURPOSE. FURTHER, VENDOR SHALL HAVE NO LIABILITY WHATSOEVER TO PURCHASER OR ANY THIRD PARTY FOR ANY SPECIAL, INDIRECT, PUNITIVE, INCIDENTAL, OR CONSEQUENTIAL DAMAGES. Vendor assumes no responsibility for any defects caused by third parties. This Limited Warranty gives the purchaser specific legal rights; a purchaser may have other rights depending upon where he or she lives. Some jurisdictions do not allow the exclusion or limitation of special, incidental or consequential damages, or limitations on how long a warranty lasts, so the above exclusion and limitations may apply to you.

Vendor does not authorize any person or company to assume for it any other obligation or liability in connection with the sale, installation, use, removal, return, or replacement of its equipment, and no such representations are binding on Vendor.

ASSEMBLY INSTRUCTIONS

2.5-Gal. Fryer

READ ALL SAFETY WARNINGS & ASSEMBLY INSTRUCTIONS CAREFULLY BEFORE ASSEMBLING OR OPERATING YOUR FRYER. Inspect contents in the box to ensure all parts are included and undamaged.

FOR MISSING PARTS OR ASSISTANCE, PLEASE CALL 1-800-864-6194 M-F 8am - 5pm CST.

Proof of purchase will be required.

Model #700-725

TOOLS REQUIRED: PARTS INCLUDED:

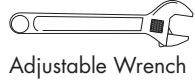

Adjustable Wrench

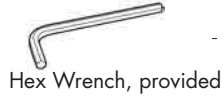

Hex Wrench, provided



Thermometer Wrench, provided



1 - Fryer Body



1 - Stainless Steel Basket



1 - Regulator Hose Assembly with Gas Inlet Cover

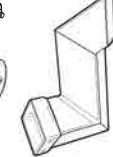

1 - Exhaust Vent



1 - Drain Hose



1 - Thermometer

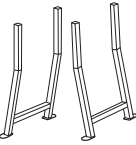

2 - Extension Legs

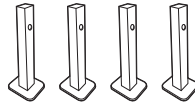

4 - Short Legs

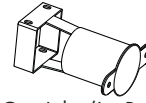

1 - Gas Inlet/Jet Burner

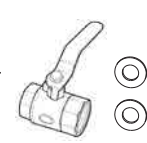

1 - Drain Valve with 2 Gaskets



1 - Hex Wrench



1 - Thermometer Wrench



4 - Large Hex Bolts/Washers/Nuts for either Extension Legs or Short Legs



4 - Short Hex Bolts/Washers/Nuts for Gas Inlet



2 - Long Hex Bolts/Washers/Nuts for Heat Exhaust

1. Attach **LEGS** to base of fryer:

(a) **Freestanding application:** Slide Extension Legs into holes on the Fryer. Attach using the 4 Large Hex Bolts/Washers/Nuts.

-OR-

(a) **Tabletop application:** Slide 4 Short Legs into holes on the Fryer. Attach using the 4 Large Hex Bolts/Washers/Nuts.

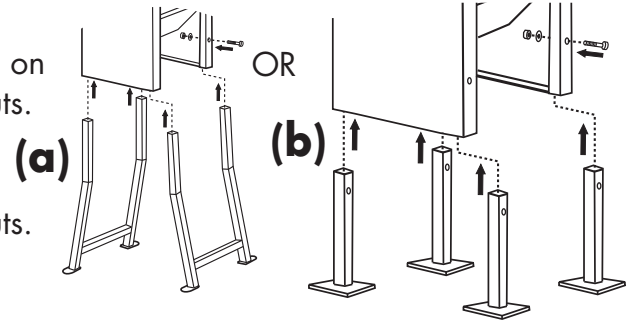

⚠ WARNING ⚠ This fryer must be operated with either the short or long legs attached.

2. (a) Attach **EXHAUST VENT** to **LEFT** opening on back of Fryer using 2 Long Hex Bolts/Washers/Nuts.

Check to verify that all connections on the pre-assembled Gas Inlet/Jet Burner are screwed together tightly.

(b) Attach the **GAS INLET** to **RIGHT** opening on back of Fryer using 4 Short Hex Bolts/Washers/Nuts. Attach **REGULATOR HOSE ASSEMBLY** with **GAS INLET COVER** to **GAS INLET** using pre-attached Hex Bolts/Nuts.

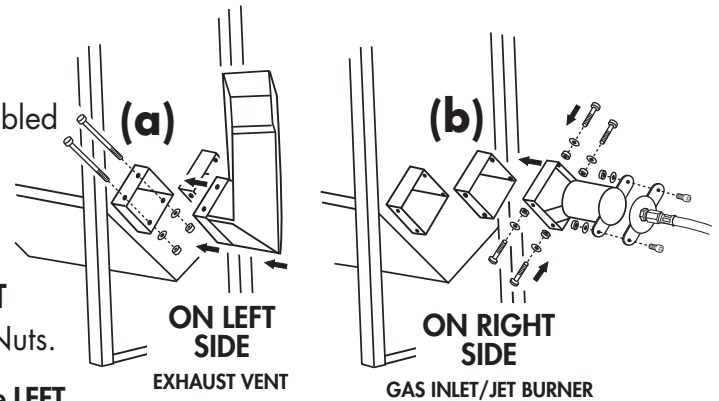

⚠ WARNING ⚠ Exhaust vent **MUST** be attached to the **LEFT** opening on back panel so that exhaust flows **AWAY** from burner intake and **AWAY** from the person lighting the burner.

3. Screw Drain Valve onto Fryer Body. Wrench tighten. **NOTE: When Attaching Drain Valve, make sure that the Locking Tab for Handle is positioned towards the Fryer Body.**

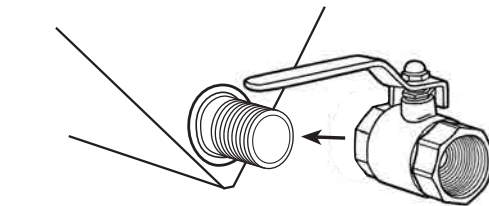

4. Lock Basket Handle into place by inserting handle into loops on Basket. Then with some pressure, carefully force Basket Handle Bars around the clasp on the Basket.

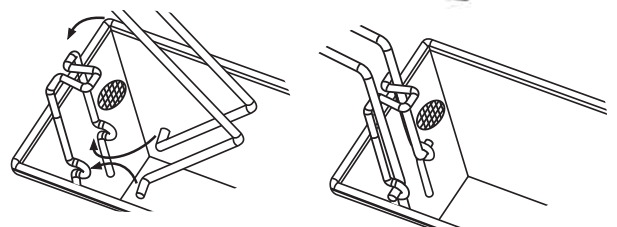

5. Attach Regulator Hose Assembly to Brass Connector on Gas Inlet/Jet Burner. **Refer to pages 8 - 9.**

4-Gal. Fryer

ASSEMBLY INSTRUCTIONS

READ ALL SAFETY WARNINGS & ASSEMBLY INSTRUCTIONS CAREFULLY BEFORE ASSEMBLING OR OPERATING YOUR FRYER. Inspect contents in the box to ensure all parts are included and undamaged.

FOR MISSING PARTS OR ASSISTANCE, PLEASE CALL 1-800-864-6194 M-F 8am - 5pm CST.

Proof of purchase will be required.

Model #700-701

TOOLS REQUIRED:



Adjustable Wrench



Hex Wrench, provided



Thermometer Wrench, provided

PARTS INCLUDED:



1 - Fryer Body

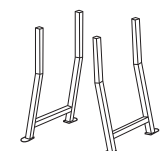

2 - Extension Legs for Legs

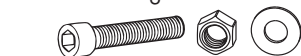

4 - Large Hex Bolts/Washers/Nuts for Extension Legs



2 - Stainless Steel Baskets

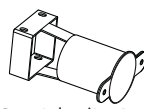

1 - Gas Inlet/Jet Burner



1 - Exhaust Vent



1 - Regulator Hose Assembly with Gas Inlet Cover

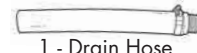

1 - Drain Hose



1 - Thermometer



1 - Hex Wrench

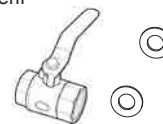

1 - Drain Valve with 2 Gaskets

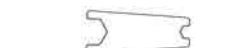

1 - Thermometer Wrench

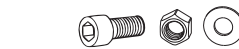
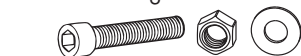

4 - Short Hex Bolts/Washers/Nuts for Gas Inlet

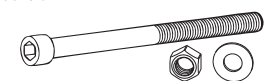

2 - Long Hex Bolts/Washers/Nuts for Heat Exhaust

- Slide Extension Leg into holes on the Fryer. Attach using the 4 Large Hex Bolts/Washers/Nuts.

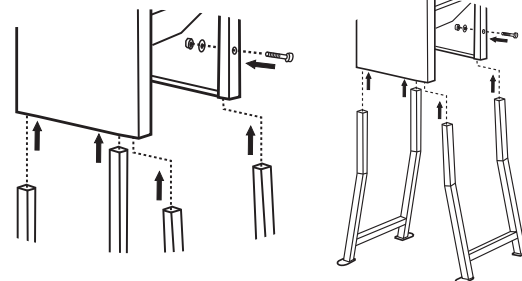

- Attach **EXHAUST VENT** to **LEFT** opening on back of Fryer using 2 Long Hex Bolts/Washers/Nuts. Check to verify that all connections on the pre-assembled Gas Inlet/Jet Burner are screwed together tightly.

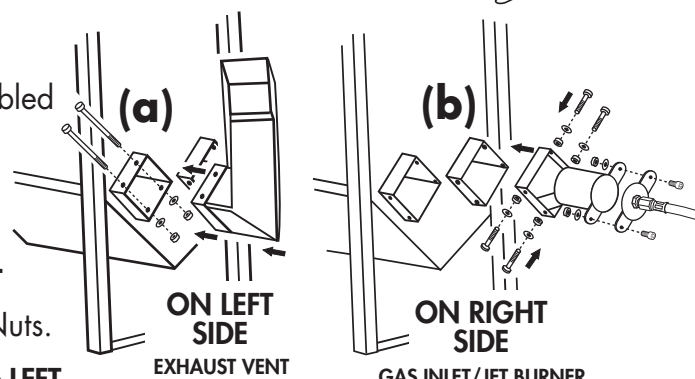

- Attach the **GAS INLET** to **RIGHT** opening on back of Fryer using 4 Short Hex Bolts/Washers/Nuts. Attach **REGULATOR HOSE ASSEMBLY** with **GAS INLET COVER** to **GAS INLET** using pre-attached Hex Bolts/Nuts.

⚠ WARNING ⚠

Exhaust vent **MUST** be attached to the **LEFT** opening on back panel so that exhaust flows **AWAY** from burner intake and **AWAY** from the person lighting the burner.

- Screw Drain Valve onto Fryer Body. Wrench tighten. **NOTE: When Attaching Drain Valve, make sure that the Locking Tab for Handle is positioned towards the Fryer Body.**

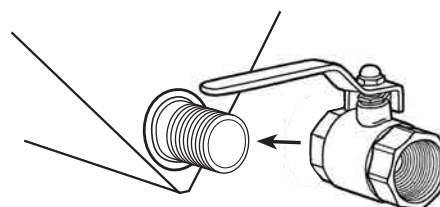

- Lock Basket Handle into place by inserting handle into loops on Basket. Then with some pressure, carefully force Basket Handle Bars around the clasp on the Basket.

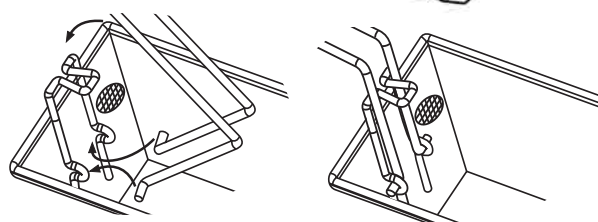

- Attach Regulator Hose Assembly to Brass Connector on Gas Inlet/Jet Burner. **Refer to pages 8 - 9.**

9-Gal. Fryer

ASSEMBLY INSTRUCTIONS

READ ALL SAFETY WARNINGS & ASSEMBLY INSTRUCTIONS CAREFULLY BEFORE ASSEMBLING OR OPERATING YOUR FRYER. Inspect contents in the box to ensure all parts are included and undamaged.

FOR MISSING PARTS OR ASSISTANCE, PLEASE CALL 1-800-864-6194 M-F 8am - 5pm CST.

Proof of purchase will be required.

Model #700-709

TOOLS REQUIRED:



Adjustable Wrench

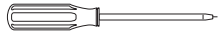

Phillips Head Screwdriver



Hex Wrench, provided



Thermometer Wrench, provided

PARTS INCLUDED:



1 - Fryer Body



1 - Cart Bottom



2 - Locking Casters



2 - Wheels

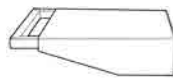

1 - Side Shelf

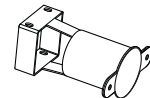

1 - Gas Inlet/
Jet Burner



3 - Stainless Steel Baskets



1 - Wheel Axle



2 - Side Shelf Brackets

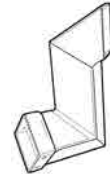

1 - Exhaust Vent



1 - Regulator
Hose Assembly
with Gas Inlet Cover



1 - Drain Valve
with 2 Gaskets



1 - Tank Hook



1 - Thermometer



1 - Hex Wrench



1 - Thermometer Wrench

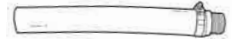

1 - Drain Hose



1 - Wingnut
for Tank Hook



2 - Acorn Nuts/Washers
for Wheels



2 - Acorn Nuts
for Side Shelf



4 - Hex Bolts
for Side Shelf



4 - Large Hex Bolts/Washers/Nuts
for Cart Bottom



4 - Short Hex Bolts/Washers/Nuts
for Gas Inlet

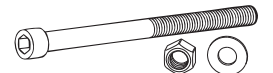

2 - Long Bolts/Washers/Nuts
for Heat Exhaust



This Fryer is HEAVY! Moving, unpacking and assembly is a TWO PERSON operation. Before lifting onto cart, open lid and remove all components and packaging from inside.

- Place Cart Bottom upside down on floor and slide in Wheel Axle. Attach both Large Wheels using Acorn Nuts and Washers.

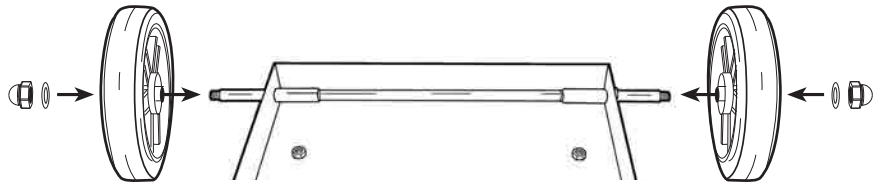

- Screw on Locking Casters in front holes of Cart Bottom. Wrench Tighten.

Flip over Cart Bottom, right side up.

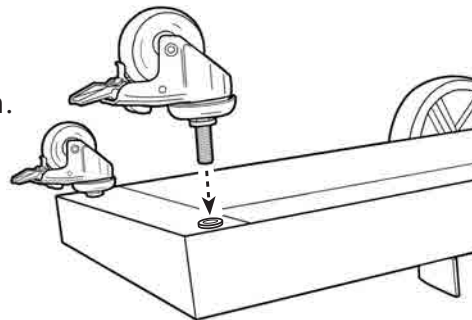

- When placing Fryer Body on Cart Bottom, make sure the **Tank Hook** on Fryer Body will align with the **Tank Rest** on Cart Bottom.

Carefully lift Fryer Body and place on top of Cart Bottom. Align the brackets on Fryer Body to the holes on Cart Bottom.

Attach using 4 Large Hex Bolts/Washers/Nuts.

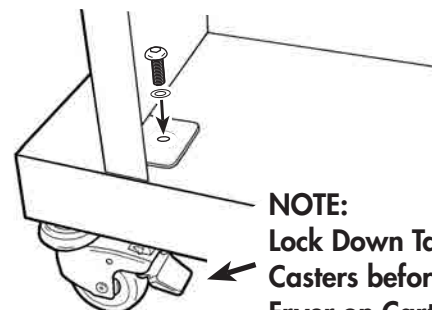

NOTE:
Lock Down Tabs on
Casters before placing
Fryer on Cart

4. Attach 2 Acorn Nuts on Shelf Side of Fryer as shown below. Then Slide Side Shelf onto Acorn Nuts on side of Fryer Wall.

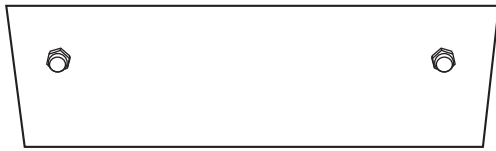

Acorn Nuts attach to Fryer Wall

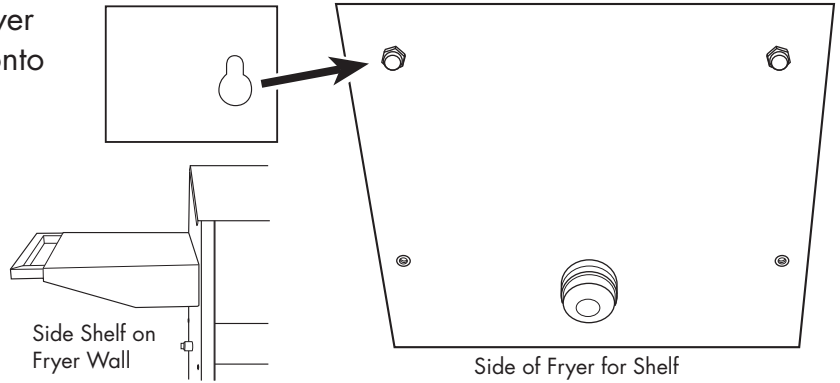

Side Shelf on Fryer Wall

Side of Fryer for Shelf

5. Attach Shelf Brackets to Side Shelf and Fryer using 4 Small Hex Bolts/Washers.

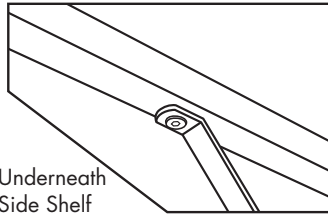

Underneath Side Shelf

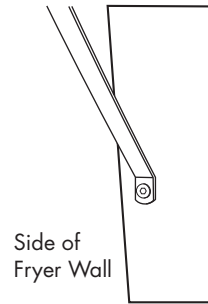

Side of Fryer Wall

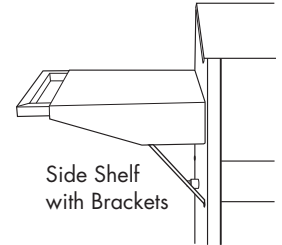

Side Shelf with Brackets

6. (a) Check to verify that all connections on the pre-assembled Gas Inlet/Jet Burner are screwed together tightly. Attach the **GAS INLET** to the **LEFT** opening on back of Fryer using 4 Short Hex Bolts/Washers/Nuts.
- (b) Attach **EXHAUST VENT** to **RIGHT** opening on back of Fryer using 2 Long Hex Bolts/Washers/Nuts. Attach **REGULATOR HOSE ASSEMBLY** with **GAS INLET COVER** to **GAS INLET** using pre-attached Hex Bolts/Nuts.

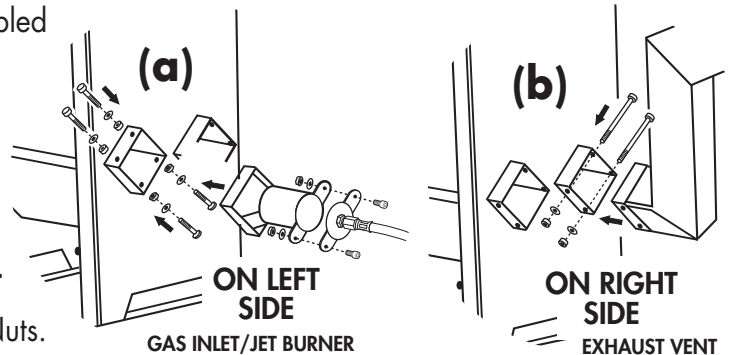

ON LEFT SIDE

GAS INLET/JET BURNER

ON RIGHT SIDE

EXHAUST VENT

⚠ WARNING ⚠ Exhaust vent **MUST** be attached to the **RIGHT** opening on back panel so that exhaust flows **AWAY** from burner intake and **AWAY** from the person lighting the burner.

7. Screw Drain Valve onto Fryer Body. Wrench tighten. **NOTE: When Attaching Drain Valve, make sure that the Locking Tab for Handle is positioned towards the Fryer Body.**

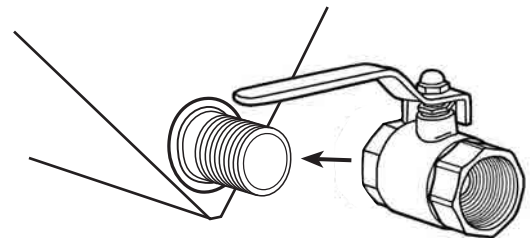

8. Lock Basket Handle into place by inserting handle into loops on Basket. Then with some pressure, carefully force Basket Handle Bars around the clasp on the Basket.

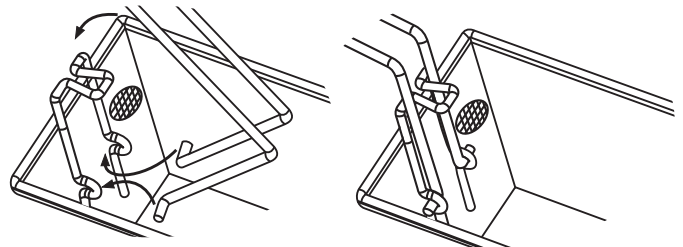

9. Attach Regulator Hose Assembly to Brass Connector on Gas Inlet/Jet Burner. **Refer to pages 8 -9.**

LP GAS CYLINDER SPECIFICATIONS

! DANGER !



CARBON MONOXIDE HAZARD

This appliance can produce carbon monoxide which has no odor.

Using it in an enclosed space can kill you.

Never use this appliance in an enclosed space such as a camper, tent, car or home.

! WARNING !

LP GAS CYLINDER (NOT SUPPLIED WITH THIS APPLIANCE)

The LP (Liquid Propane) gas cylinder specifically designed to be used with this fryer must have a 20 lb (9.1 kg) capacity incorporating a Type-1 cylinder valve and an over-filling protection device (OPD).

- DO NOT connect this cooker to an existing #510 POL cylinder valve with Left Hand Threads. The Type-1 valve can be identified with the large external threads on the valve outlet.
- DO NOT connect to a propane cylinder exceeding this capacity.
- DO NOT connect to a cylinder that uses any other type of valve connection device.

LP GAS CYLINDER

To check your local codes, see your local LP gas dealer or natural gas company. This appliance is not intended to be connected to a natural gas supply line.

When purchasing or exchanging a cylinder for your gas cooker, it must be constructed and marked in accordance with the specifications for LP gas cylinders by the U.S. Department of Transportation (DOT) or the National Standard of Canada, CAN/CSA-B339, Cylinders, Spheres and Tubes for the Transportation of Dangerous Goods as applicable with a listed over-filling device (OPD).

The cylinder must also be equipped with:

- A shut-off valve terminating in a Type-1 gas cylinder valve outlet.
- A Type-1 valve that prevents gas flow until a positive seal is obtained.
- An arrangement for vapor withdrawal.
- A collar to protect the cylinder shut-off valve.
- A safety relief device having direct communication with the vapor space of the cylinder.
- A listed Over-filling Prevention Device (OPD).
- A protective cap on cylinder Type-1 Outlet.

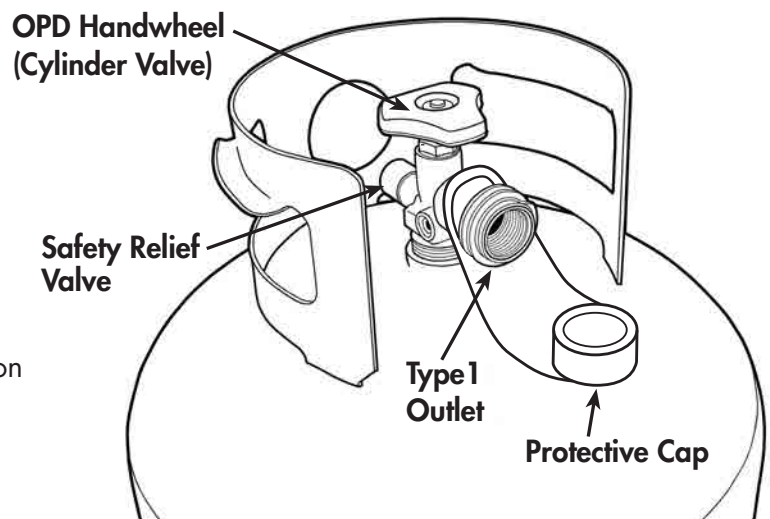

⚠️ WARNING ⚠️

- Turn off the cylinder valve when your fryer is not in use.
- Handle the LP gas cylinder with care.
- Always secure the LP gas cylinder in an upright position.
- Never connect an unregulated LP gas cylinder to your fryer.
- DO NOT expose LP gas cylinders to excessive heat or ignition sources.
- DO NOT store a spare LP gas cylinder near your fryer.
- Allow only qualified LP gas dealers to fill or repair your LP gas cylinder
- DO NOT allow the LP gas cylinder to be filled beyond 80% capacity.
- Read and follow all warnings/instructions that are on the cylinder and that accompany this product.

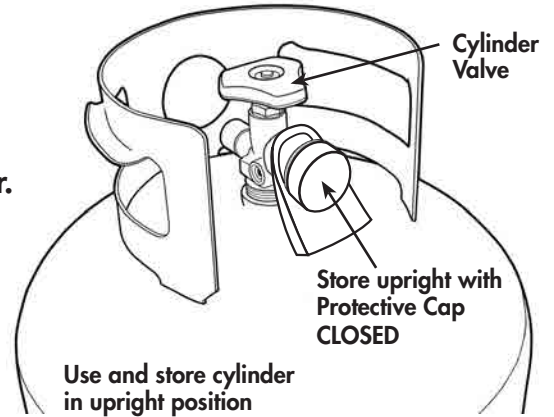

⚠️ DANGER ⚠️

- Never store spare LP gas cylinder near your fryer. This could cause excess pressure to be expelled through the vapor relief valve resulting in fire, explosion, or severe personal injury, including death.
- NOTE: PROPANE GAS IS HEAVIER THAN AIR AND WILL COLLECT IN LOW AREAS. PROPER VENTILATION IS EXTREMELY IMPORTANT**
- Keep the ventilation opening(s) of the LP gas cylinder enclosure free and clear from obstruction and debris.
 - DO NOT insert any foreign objects into the valve outlet. Damage to the back-check could result. A damaged back-check can cause a leak, possibly resulting in explosion, fire, severe personal injury, bodily harm or death.

⚠️ WARNING ⚠️

FILLING THE LP GAS CYLINDER:

- Allow only qualified LP gas dealers to properly fill or repair your LP gas cylinder.
- New tanks should be purged prior to filling; inform LP gas dealer if you are using a new tank.
- DO NOT allow the cylinder to be filled beyond 80% capacity. Over-filled tanks can create a dangerous condition. Over-filled tanks can build up pressure and cause the relief valve to expel propane gas vapors. The vapor is combustible and if it comes in contact with a spark source or flame; an explosion causing severe burns, bodily harm, or death could occur.
- Always use a protective cylinder cap when cooker is not connected to cylinder.
- If you exchange a cylinder with a qualified exchange program, be sure the cylinder has a Type-1 valve and an over-filling prevention device (OPD).

THERMOMETER TEST INSTRUCTIONS

The thermometer supplied with your fryer is Model #5070. It is a sensitive measuring device which may not work properly if dropped, bent, or twisted.

To order a replacement thermometer, call 1-800-864-6194, M - F 8am - 5pm CST for assistance. You should test your thermometer before you install it into your fryer.

⚠ DANGER ⚠

Always use a thermometer when frying any food products. DO NOT attempt frying if the thermometer is not working. Always check to be sure thermometer is working properly BEFORE frying.

2-STEP METHOD for Thermometer Testing

1. TEMPERATURE ACCURACY:

While wearing protective gloves, hold the thermometer by the dial and insert stem into boiling water. The needle should quickly move around the dial and register approximately 212°F (100°C) (plus or minus 5°F). This indicates whether or not temperature reading is accurate.

NOTE: Due to water evaporation, the max reading possible on a thermometer in hot water is 212°F (100°C).

2. TEMPERATURE RANGE:

Hold thermometer by the dial and place end of the stem above a lit match or lighter. The needle should quickly move around the dial and register a temperature reading far above 350°F. If the needle stops at a low temperature reading such as 225°F; then the thermometer is damaged and cannot be used. Discard the thermometer and order a replacement thermometer (Model #5070).

If you are uncertain about any aspect of testing or operating your fryer:
Call 1-800-864-6194 Monday - Friday, 8am - 5pm CST for assistance.

THERMOMETER ATTACHMENT INSTRUCTIONS

1. Test the thermometer to insure it accurately measures temperature as shown above.
2. Before installing thermometer, make sure the rubber gasket is located on stem of thermometer underneath brass nut.
3. Insert Thermometer into hole on front of fryer. Make sure the thermometer face is in the upright position. Gently turn the **brass nut** clockwise  until thermometer is secure.
4. Using wrench provided, tighten **brass nut** of thermometer until it is tightly secured to Fryer Stem.

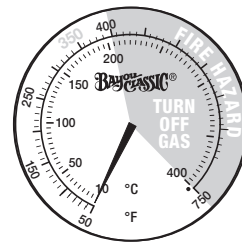

Upright Position

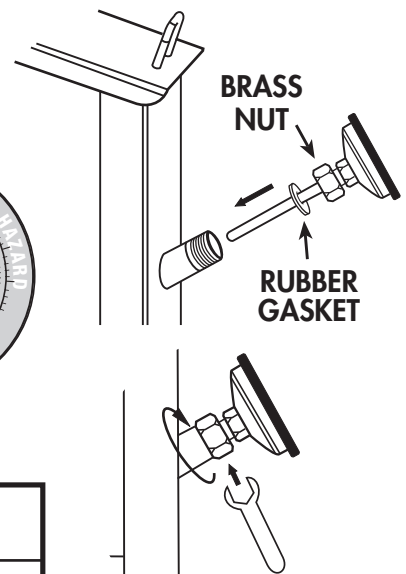

⚠ CAUTION ⚠

DO NOT tighten top nut on stem. Tightening the top nut will also turn the dial and the temperature calibration will be compromised.

5. After attaching thermometer, check to make sure thermometer needle is pointing near actual outside ambient temperature number.

REGULATOR HOSE ASSEMBLY

The hose supplied with your fryer is Model #M5HPR-1. It is designed to work with a LP Gas Cylinder and is a Type-1 connection device with the following features:

1. The system will not allow gas flow from the cylinder until a **positive connection** to the cylinder valve has been made.

NOTE: The cylinder valve must be turned off (clockwise) before any connection is made or removed.

2. A **flow limiting device**, when activated, restricts the flow of gas to 10 cubic feet per hour.

NOTE: the flow limiting device can be activated when attempting to light fryer. If this occurs, refer to **Trouble Shooting** on page 21.

A replacement regulator can be supplied by contracting Barbour International, Inc. at 1-800-864-6194. Only use replacement regulator hose assembly #M5HPR-1. This regulator is designed to operate at a maximum out put pressure of 10 psi (pounds per square inch).

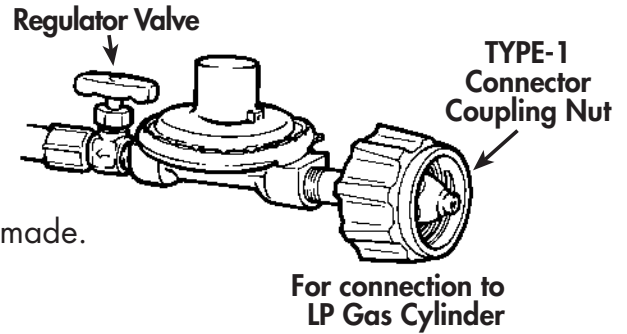

⚠ CAUTION ⚠

The valve on the regulator hose assembly controls flame intensity **ONLY**. It is not an ON/OFF valve.

⚠ WARNING ⚠

- **DO NOT attempt to connect it to any other fuel supply source such as a natural gas line.**
- **DO NOT use any other pressure regulator/hose assembly than the one supplied with your fryer.**
- **DO NOT attempt to adjust or repair the regulator.**
- **DO NOT attempt to disconnect the regulator hose assembly while fryer is in operation.**

INSPECTING REGULATOR HOSE ASSEMBLY

The Regulator Hose Assembly is a pre-assembled unit. Do not take apart. Prior to each use, visually inspect the regulator hose assembly. If there is evidence of abrasion, wear, cuts or leaks, the hose must be replaced prior to the appliance being put into operation. To remove, use a wrench to loosen the brass connector on the hose. To reattach, wrench tighten the brass connector back to the burner assembly.

Call 1-800-864-6194 for replacement Model #M5HPR-1. M-F 8am - 5pm CST.

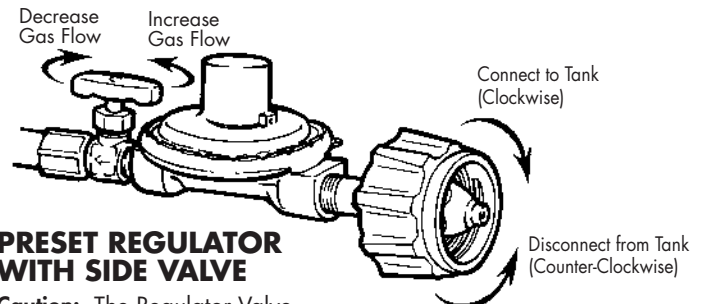
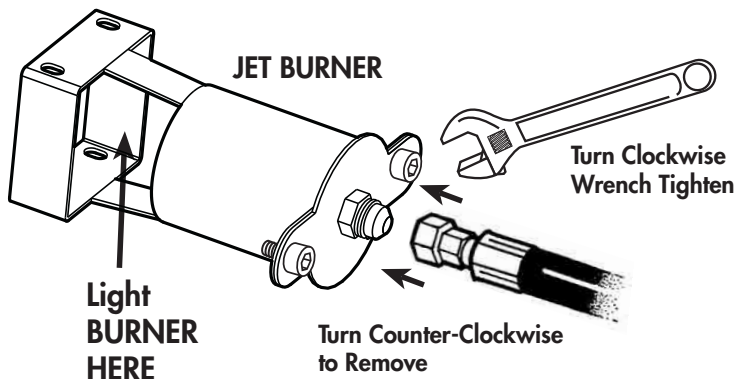

PRESET REGULATOR WITH SIDE VALVE

Caution: The Regulator Valve Controls the "Volume" of Gas **ONLY**. Use the Valve on the Propane Tank to turn Gas Supply "ON" or "OFF".

CONNECTING REGULATOR HOSE ASSEMBLY TO LP GAS CYLINDER

1. Check that cylinder is upright and the valve is closed by turning the knob clockwise.
2. Check that the Regulator Control Valve is also closed by turning the knob clockwise.
3. Remove the protective safety caps from the cylinder valve and the Type-1 Coupling Nut on the regulator.
4. Insert the nipple of large coupling nut into the cylinder valve outlet. Insure that the coupling nut is centered properly.
5. Turn the large coupling nut clockwise by hand and tighten to a full stop. Take care not to cross thread the coupling nut onto the cylinder valve. Do not use tools to tighten connection.

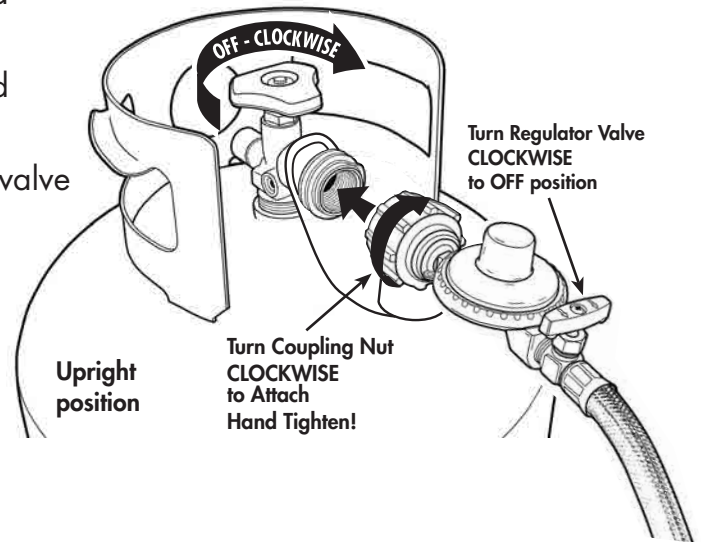

NOTE: If you are unable to make the connection, repeat steps 4 and 5.

6. Check that the hose does not contain kinks, does not come into contact with sharp edges, and does not contact surfaces that may become hot during use.
7. Leak check all fittings before lighting fryer. Refer to pages 12 - 13 for **Gas Leak Test Instructions**.

GAS LEAK TESTING

⚠ DANGER ⚠

To prevent fire or explosion hazard:

- DO NOT smoke or permit ignition sources in the area while conducting a leak test.
- Perform test OUTDOORS only in a well ventilated area at least 10-ft away from any structure or trees.
- Never perform a leak test with a match or open flame.
- Never perform a leak test while the appliance is in use or while fryer is still hot.

⚠ WARNING ⚠

WHEN TO PERFORM A LEAK TEST

- After assembling your fryer and before lighting for the first time, even if purchased fully assembled.
- Every time the LP gas cylinder is refilled or if any of the gas components are replaced.
- Every time you use your fryer.

GAS LEAK TEST INSTRUCTIONS

Note: The gas leak test must be performed in an area that has adequate lighting in order to see if bubbles are developing.

DO NOT use a flashlight to check for bubbles.

1. Create a mixture of 50% water and 50% liquid dishwashing soap.
2. Turn the gas cylinder valve to the OFF position (clockwise). Then turn regulator control valve to OFF position (clockwise).
3. To turn ON the fuel supply, turn the cylinder valve knob one turn counter-clockwise. Gas will flow through and stop at the regulator.
4. Using a clean brush, apply the soap water mixture to the following:

- A** Cylinder Valve to Cylinder
- B** Connection Nut to Cylinder Valve
- C** Back side of Connection Nut to Brass Nipple
- D** Control Valve next to Regulator
- E** Regulator connection to Gas Supply Hose
- F** LP Cylinder Welds
- G** Gas Supply Hose connection to Burner on Fryer
- H** Full length of Gas Supply Hose

5. Check each place **A - F** for growing bubbles which indicates a leak.

6. Next, turn ON regulator valve (clockwise) to permit gas to pass through the hose. Apply soap water mixture to full length of gas supply hose and connection to burner on fryer. Check each place for growing bubbles, **G & H**, which indicates a leak.

7. Turn OFF gas supply valve (clockwise) on LP Gas Cylinder.
8. Turn regulator control valve to OFF position (clockwise).
9. Tighten any leaking connections.

10. Repeat soap water mixture test until no leaks are detected.

DO NOT use fryer if gas leaks cannot be stopped.

Call 1-800-864-6194 M-F 8am - 5pm CST for assistance, or contact a qualified appliance repair service.

11. After you are certain there are no leaks, turn tank valve and regulator control valve to OFF position. Wait 5 minutes for any gas fumes to evacuate before lighting the burner on fryer.

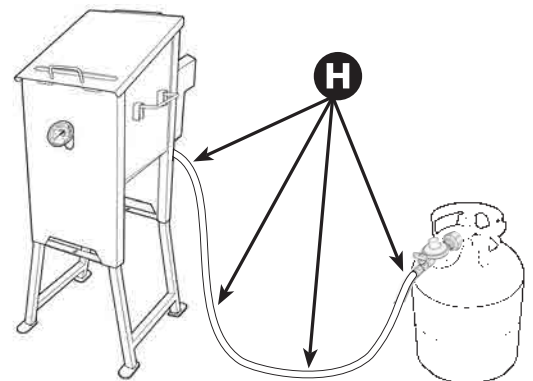
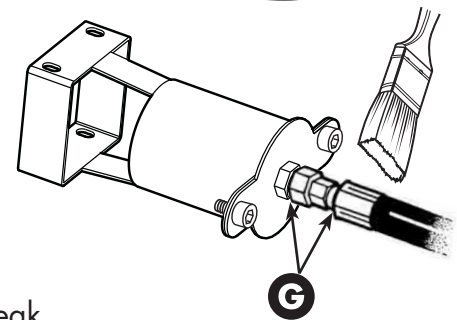
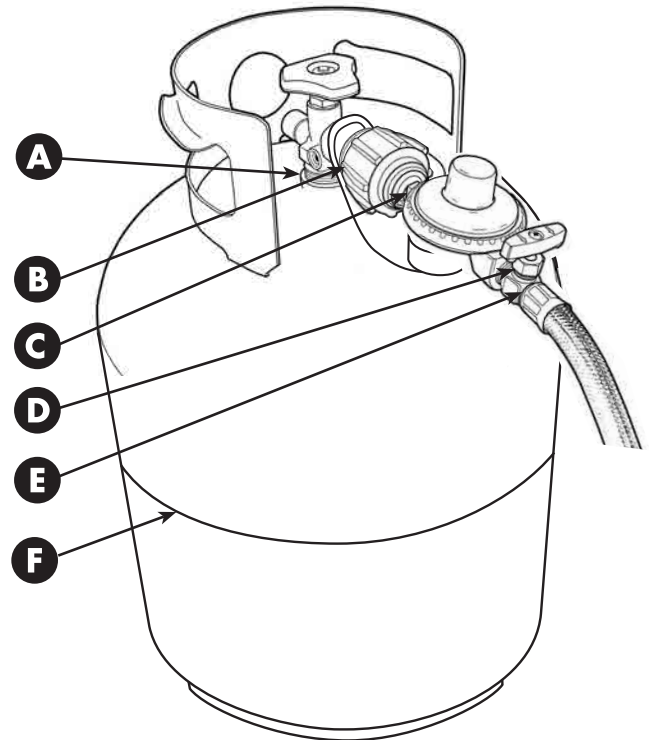

Watch for Bubbles



GAS SUPPLY HOSE

⚠️ WARNING ⚠️

If growing soap bubbles persist throughout any portion of the Gas Leak Test, terminate use immediately. For assistance, contact your propane dealer or Barbour International, Inc. at 1-800-864-6194.

FRYER SET-UP

1. Read and understand everything in this manual.
2. Insure that the fryer is properly assembled and connected to propane cylinder.
3. Inspect the gas supply hose for burns, chaffing, kinks and proper routing before each use.
4. Perform full **Gas Leak Test**. Refer to pages 12 - 13 for Testing Instructions.
5. Test thermometer to insure it is working properly. Refer to page 10 for **Thermometer Testing**.
6. Clean the inside of your fryer with soap and water.
7. Determine proper amount of cooking oil to use. Refer to page 18 for **Proper Amount of Oil**.
8. Inspect the heat tube for obstructions. Remove vent and intake and wash with hose if necessary.
9. Have a BC or ABC type fire extinguisher readily accessible.
10. Practice using the fryer with water in the vessel to become familiar with its operation before frying. Refer to page 16 for **Lighting Instructions**.
11. Replace any parts that show wear, abrasion, cuts, have leaks, or that fail during testing.

POSITIONING THE FRYER

1. Position the fryer on level ground in a well ventilated location, a safe distance from combustible materials, buildings and overhangs.
2. Position the fryer on a non-combustible surface.
3. Position the fryer in an area away from children and pets, and out of normal foot traffic paths.
4. Position fryer **DOWNWIND** from the nearest structure; no closer than 10-ft from nearest building or railing, keeping flames from any potential oil/grease fire away from nearest structure.
5. Position fryer **DOWNWIND** from the LP Gas Cylinder keeping a minimum distance of 20" apart so the heat of the fryer does not reach cylinder.
6. Gas supply hose should be positioned at least 3 inches away from hot surfaces.
7. Insure that all electrical supply cords are properly grounded and kept away from this appliance.

↑ **Make sure overhead is clear of combustible materials!** ↑

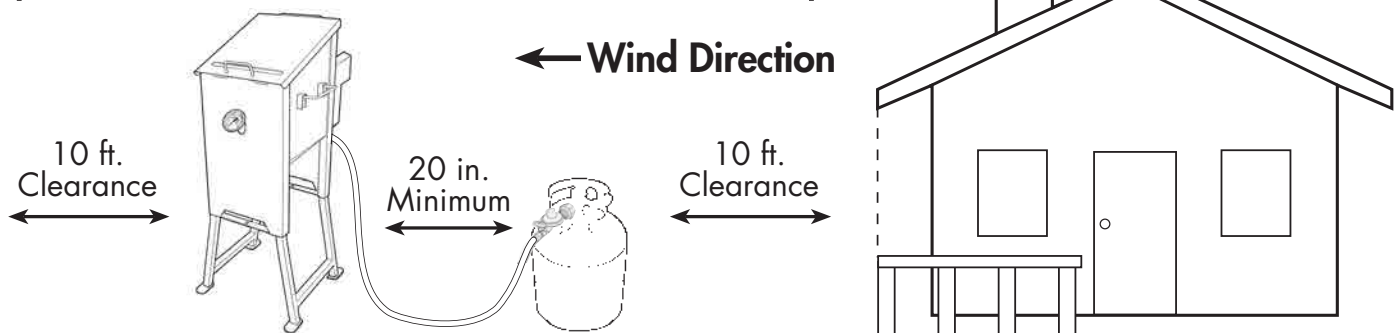

WARNING Hose is a trip hazard. Do not walk between fryer and cylinder.

! WARNING !

Use only the parts and accessories provided by Bayou Classic for use with this appliance. Using any other product is considered unintended use of the product and voids the warranty. Call 1-800-864-6194 M - F 8am - 5pm CST for all replacements parts.

! DANGER !

- **DO NOT** operate this gas appliance closer than 10 ft (3m) from any combustible material, including; walls, railings, overhead construction, tree branches.
- **DO NOT** store or use gasoline or other liquid/aerosols with flammable vapors within 25 ft (7.5m) of this fryer.
- **DO NOT** position or operate this appliance on any combustible material, including: decks, RV's, boats, or on the tailgate or bed of a pick-up truck.

SET-UP FOR 2.5-GAL. TABLETOP APPLICATION

⚠ DANGER ⚠

ONLY the 2.5 GALLON Fryer can be adapted for tabletop use.

1. Always adhere to all instructions and warnings in this manual. Using the tabletop feature **DOES NOT EXEMPT** any of the instructions or warnings found in this manual.
2. Attach the short legs as outlined in the assembly instructions on page 4, Step 1b.
3. Even in the tabletop application, this fryer shall be used **OUTDOORS ONLY**.
4. Position the fryer on a stable, flat, non-combustible surface like granite, stone, concrete, or metal.
NOTE: A wood tabletop IS a combustible surface.
5. Position the fryer away from any combustible material, tipping hazards, or other controllable environment factors.
6. The fryer should be at a comfortable height for the qualified operator to use without risk of dripping/spilling/splashing hot grease or food on themselves or others.
NOTE: It is NOT recommended that the fryer be placed on a surface greater than 36" from the standing floor plane. DO NOT Operate the fryer on a pick-up truck bed or tailgate.
7. Locate the fryer in a place where it cannot be pushed off tabletop.
8. DO NOT put the propane tank on a table or countertop.

⚠ CAUTION ⚠

To prevent damage to the tabletop finish, use a non-flammable, heat-resistant coaster or placemat between the appliance and the tabletop surface. Never place on carpet, wooden furniture, or other combustible materials.

↑ Make sure overhead is clear of combustible materials! ↑

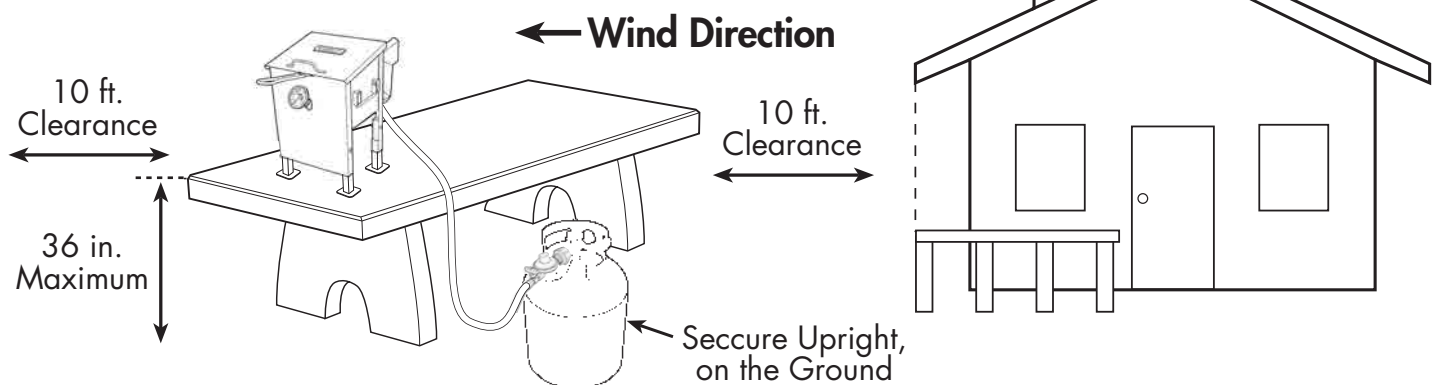

⚠ WARNING ⚠

Hose is a trip hazard. Do not walk between fryer and cylinder.

LIGHTING INSTRUCTIONS

⚠ DANGER ⚠

Keep head, hair and face away from exhaust vent when lighting. A flash flame can emit from the exhaust vent during initial burner lighting, igniting hair and clothing.

BEFORE LIGHTING

Make sure LP Cylinder is OFF clockwise

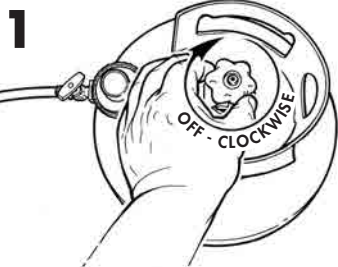

Make sure Regulator Valve is OFF clockwise

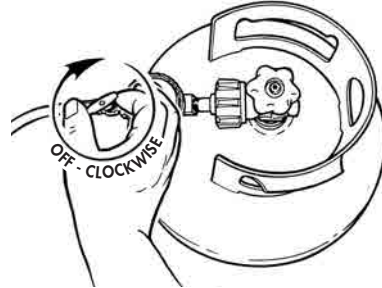

S-L-O-W-L-Y Turn LP Cylinder Valve One Full Turn counter-clockwise

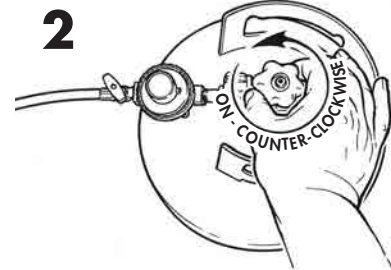

Gas will flow to and stop at closed regulator

LIGHTING

Place lit Match in Gas Inlet

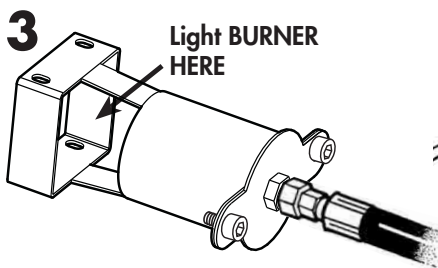

S-L-O-W-L-Y Turn Regulator Valve ON counter-clockwise

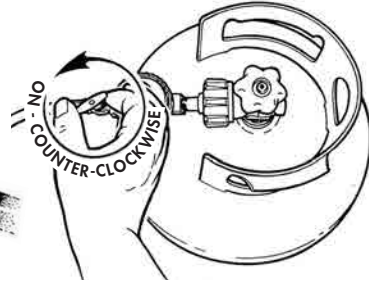

⚠ WARNING ⚠

If the burner does not light within the first few attempts, there is a problem with the gas supply. Turn off the gas at the cylinder and regulator. DO NOT attempt to operate fryer until the problem is found and corrected. Refer to Troubleshooting Tips on page 21.

ADJUST Regulator Valve for Flame Intensity counter-clockwise

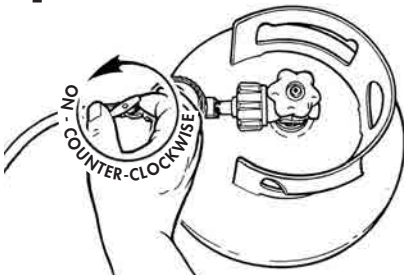

NOTE: The brass valve on regulator hose assembly controls flame intensity only. It is not an ON/OFF valve.

After lighting Fryer, OPEN LP Cylinder Valve FULLY counter-clockwise

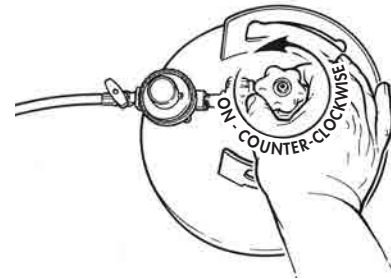

- If burner flame does NOT ignite immediately, or is accidentally extinguished, turn off the LP cylinder and regulator.
- Wait 5 minutes for gas to evacuate before re-lighting.
- Follow steps 1 - 5 above to reignite burner.

⚠ DANGER ⚠

Always use caution when re-lighting as appliance frame and oil will be HOT.

TURNING OFF THE FRYER

1. Turn off LP gas cylinder valve first to prevent gas from being left in the regulator hose system under pressure. This will allow the propane gas to "bleed" from the regulator hose and assembly.
2. Turn regulator valve to the OFF position.
3. Disconnect the regulator hose assembly from the LP cylinder to store the unit.

OPERATING INSTRUCTIONS

1. Follow all instructions for Set-Up and Testing as described on pages 12 - 15. **DO NOT** skip of the warnings and instructions contained in the preceding sections of this manual.
2. Add the determined amount of oil/grease into the frying chamber. Refer to page 18.
3. Prepare your food for frying before lighting the fryer. Make sure food is completely thawed and dry. Properly preparing food ahead of time allows the operator to never have to leave the fryer unattended and reduces the risk of spillover due to oil boiling over.
4. Light the burner on the fryer as described and adjust the flame intensity with the regulator control valve to desired level.
5. Stay with your fryer. Once Fryer is lit and has begun heating the oil, do not leave the fryer unattended until cooking is finished and the oil has cooled to 115°F.
6. Keep the lid open. The lid must remain open during heat-up and frying. Closing the lid during heat-up and frying greatly increases the potential of over-heating the oil to ignition and fire.
7. Wait for the oil to reach optimum frying temperature. It takes only 5 - 10 minutes to reach optimum frying temperature range of 325°F to 350°F (163°C to 177°C).
8. Once the oil reaches 325°F to 350°F, reduce the burner flame to a low level.
9. Frequently check the thermometer (every 3 minutes), and NEVER allow the oil to reach a temperature over 400°F. This is labeled "**FIRE HAZARD**" zone on the thermometer.
10. Use extreme care when S-L-O-W-L-Y lowering food and utensils into and removing from hot oil. **NEVER** drop food into hot oil.
11. When cooking is completed, turn off LP cylinder and allow propane gas to "bleed" from the regulator hose and assembly. Then turn regulator valve to the OFF position.
12. Disconnect regulator hose assembly from the LP cylinder.
13. Follow **Cleaning and Storage Instructions** on page 20.

⚠ DANGER ⚠

- Hot cooking oil is extremely dangerous and must be monitored at all times during use and cool down period.
- Regardless of thermometer reading, if the oil/grease starts to smoke, turn OFF fuel supply to the burner and STOP COOKING IMMEDIATELY. This indicates the thermometer is not working properly. Discard the thermometer and call 1-800-864-6194 M-F 8am - 5pm CST for assistance.
- Immersing food into hot cooking oil/grease causes a furious boil while displacing upwards. Overfilling the fryer vessel with oil/grease, allowing the oil/grease to get too hot, or immersing frozen or wet food into hot oil can cause a spillover resulting in property damage, personal injury or death.
- This appliance does not have automatic thermostat controls so it must be monitored at all times during heat-up, frying and cool down. Use the provided thermometer to monitor frying temperature.
- Oil/grease heated above 400°F (200°C) will ignite and catch fire causing property damage, personal injury or death.
- Keep head, hair and face away from exhaust vent when lighting. A flash flame can emit from the exhaust vent during initial burner lighting, igniting hair and clothing.
- Always keep children and pets away from the cooking area during and after use, until the cool down period is completed.

COOKING OIL

FILLING THE FRYER WITH OIL:

1. Make certain that bottom drain valve is closed and burner turned off.
2. Set baskets inside the empty fryer. **IMPORTANT!**
3. Pour cool oil/grease into the fryer vessel.
4. Watch closely as oil rises and reaches the bottom of the baskets.
5. Continue pouring oil until the **bottom** of the baskets are submerged **between 1.5" to 2" deep**. Pour up to but not above the **Maximum Fill Line** marked on the back wall of the fryer.

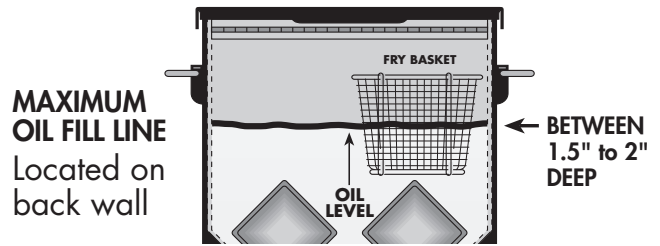

NOTE: As oil heats up, it will expand and raise level inside the baskets to about 2.5" deep. As food is inserted, oil level will rise further.

! DANGER !

TOO LITTLE OIL:

(Less than 1.5" of basket submerged in oil when cool)

- **Cooking oil will not cover the food and result in uneven doneness.**
- **Thermostat will not be adequately submerged and will not give accurate temperature readings.**
- **Oil will not fully cover the heating tube resulting in overheating of the oil and possibly ignition and fire.**

TOO MUCH OIL:

(Oil filled above Maximum Fill Line when cool)

- **Heat-up and recovery times will be slower.**
- **Immersing food will cause a furious boil displacing upwards, greatly increasing the possibility of a spillover.**
- **As oil heats up, it will expand and can result in a spill over.**

IF THESE WARNINGS ARE NOT FOLLOWED EXACTLY; PROPERTY DAMAGE, PERSONAL INJURY, OR DEATH MAY OCCUR.

MANAGING COOKING OIL:

- Monitor the temperature and oil level. You will have to occasionally make minor adjustments to the regulator valve until steady frying temperature is achieved. Optimum temperature range is 325°F to 350°F.
- Never drop food or accessories into hot oil/grease. Wear protective gloves and **S-L-O-W-L-Y** lower food and accessories into cooking oil in order to prevent splashing or overflow. Be careful when removing food from oil. It is hot and could cause burns.
- If you need to add cooking oil because the level gets too low as a result of a long-term cooking period (less than 1.5" of basket submerged in oil when hot).

FOLLOW THESE INSTRUCTIONS:

1. Turn off the fryer and LP Cylinder
 2. Let cooking oil cool for 5 minutes
 3. **S-L-O-W-L-Y** pour in new cooking oil - **DO NOT EXCEED MAXIMUM FILL LINE**
 4. Follow instructions to re-light the fryer.
- When frying is finished, do not touch the appliance or handle the oil until it has cooled to below 115°F. The cool down period varies with the amount of oil used, wind and ambient temperature.
 - In the event of rain, snow, hail, sleet or other form of precipitation while cooking with oil, close the lid and immediately turn off the burner and gas supply. **DO NOT MOVE** the fryer.
 - Properly store or dispose of our oil. Do **NOT** store cooking oil

COOKING OIL - continued

IMPORTANT FACTS TO KNOW:

1. Your fryer is designed to use liquid oil/grease and not solid fats which have to be melted before use. The most common oils used are vegetable and peanut oil.
2. Cooking oil typically does not burn when below its flashpoint temperature. The flashpoint (the temperature at which oil will burn) ranges from 550°F to 700°F, depending on type of oil used, altitude, variable wind, and ambient temperature. NOTE: the flashpoint temperature is also called the "smoke point".
3. Cooking oil contained inside the confines of a stockpot, skillet or pan (vessel) is quite stable when below its flashpoint temperature. For example, if fire or ignition source (lit cigarette, match, spark, etc.) falls into oil at 350°F, the oil will extinguish the flame similarly to falling into water.
4. As heated cooking oil approaches its flashpoint temperature it becomes unstable and begins to breakdown. As cooking oil breaks down, vapors are created that when mixed with oxygen will burn. When heated to very high temperatures, cooking oil vapors will self-ignite.
5. As vegetable oil, contained in a cooking vessel, reaches its flashpoint and self ignites:
 - The oil first becomes darker and emits an unpleasant odor.
 - At about 440°F, the oil begins emitting a pale vapor smoke.
 - At about 500°F, the smoke turns black.
 - Soon a heavy, thick black smoke belches out.
 - At about 600°F, a small flame flickers out from the oil. At this point the cooking oil has reached its point of self-ignition.
 - If the heat source below the vessel remains engaged, the flame will quickly grow.
 - All the while cooking oil burns, thick black smoke continues to belch forth.
 - Eventually, the burning cooking oil will self extinguish. The amount of time this takes depends on vessel and amount of oil (a cooking vessel with gallons of oil will self extinguish in about 20-25 minutes after first flame emits).
6. Cooking oil can be re-used. Most cooking oils recommend using oil 4 - 5 times.
7. Each time you reuse oil, the oil deteriorates and the flash point temperature decreases.
8. 100% Peanut oil is considered a very stable cooking oil having a higher flashpoint temperature than other vegetable oils.
9. Some cooking oil is sold as a "blend" of vegetable and peanut oil. According to the Food Allergy Anaphylaxis Network, "Studies show that most allergic individuals can safely eat peanut oil (Not cold pressed, expelled, or extruded peanut oil - sometimes represented as gourmet oils)." Allergic individuals should consult a physician regarding whether or not to avoid peanut oil.

! DANGER !

Cooking oil that catches fire can create a huge flame. For example, a small 12" skillet with only 1/2" deep of oil can create a flame 7 to 9-ft high! A large cooking vessel containing up to 3 gallons of oil can create a flame up to 15-ft high! This will ignite any nearby combustible material and structures.

CLEANING AND STORAGE

DRAINING, STORING & DISPOSING THE OIL

1. Wait for the oil to cool below 115°F (45°C) before touching the appliance or draining the oil.
2. This fryer comes supplied with a drain hose that attaches to the drain valve.
3. Batter from frying settles down into the V-Bottom at the drain valve. It may be necessary to scoop out the sediment before draining out the liquid.
4. Put a container directly under where oil will flow out. It is best to pour the oil through a filter or screen to remove smaller sediment and crumbs that you were not able to scoop out.

NOTE: It is best to store oil back into the original container as purchased.

5. Open the drain S-L-O-W-L-Y until the oil begins to flow.
6. If storing your oil, use an airtight container and store in a cool dark place. DO NOT store oil for more than 9-12 months, and never use oil that smells rancid.
7. If disposing your oil:



- a. DO NOT dump it down the sink or flush it down the toilet because it can clog pipes and eventually even pollute local waterways.
- b. Check with your local solid waste department to see if they have any recommendations or regulations about disposing of oil.
- c. Pour the oil into a container and throw it into the garbage, OR take it to an oil recycling center (Some cities have drop-off points for used cooking oil to be recycled into biodiesel).

CLEANING THE FRYER

WHAT YOU NEED: garden hose, bucket, dishwashing liquid and a sponge.

1. Move the empty fryer to a clean-up area.
2. Position bucket under the open drain valve, and using a garden hose rinse out the V-Bottom section.
3. Close the drain valve and add water into the fryer vessel up to the internal heat tubes.
4. Add a dab of dishwashing liquid and clean the interior with the sponge.
5. Drain the soapy water and rinse clean with garden hose.

NOTE: Intense heat at burner and exhaust vent will cause the stainless to turn dull blue. This is normal, and will not "scrub away".

STORAGE OF FRYER

1. Disconnect the LP cylinder.
2. Store fryer in a dry place. DO NOT store outside exposed to weather. If storing fryer indoors, detach and leave LP cylinders outdoors.
3. LP cylinders must be stored outdoors out of reach of children and must NOT be stored in a building, garage or any other enclosed area. See pages 10 - 11 for Use and Care of LP Gas Cylinders.
4. For long term storage, cover the burner in-take and exhaust vent with a plastic bag to prevent wasps, spiders and dirt dobbbers from building nests inside the heat tubes.
5. Drain the soapy water and rinse clean with garden hose.

NOTE: Intense heat at burner and exhaust vent will cause the stainless to turn dull blue. This is normal, and will not "scrub away".

⚠ WARNING ⚠

Storage of a gas appliance indoors is permissible ONLY if the cylinder is disconnected.

TROUBLE SHOOTING TIPS

Problems with lighting the fryer:

LP Hose Regulator assemblies and propane tanks are equipped with a **safety device** to reduce 90% of gas flow should the hose be cut or severed. **Sometimes this safety device may be activated when lighting the fryer by opening the cylinder too fast.** To prevent this, follow these steps:

1. Prior to lighting, turn regulator valve to the **CLOSED** position.

CLOCKWISE
to closed position

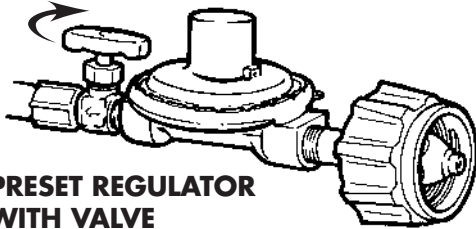

PRESET REGULATOR WITH VALVE

2. **S-L-O-W-L-Y** Turn LP Cylinder Valve **ON**
One Full Turn counter-clockwise



3. **S-L-O-W-L-Y** Turn Regulator Valve **ON** counter-clockwise to light burner

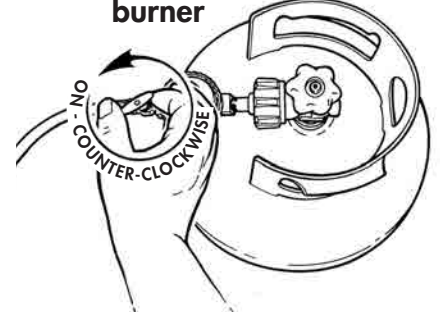

TROUBLE SHOOTING GUIDE

| SYMPTOM | CAUSE | POSSIBLE SOLUTION |
|--|--|---|
| Burner lights but the flame remains very small | Rapid gas flow from propane tank activates EXCESS FLOW safety device | Repeat lighting instructions and be certain to S-L-O-W-L-Y open cylinder valve one full turn, then S-L-O-W-L-Y open regulator valve to light burner |
| Burner will not light | Blockage in burner tube from spider webs, insects, dirt dobbers and debris | Disconnect hose from burner. Clean and check burner tube for spiders, insect nests and debris |
| Burner will not light and burner tube is clean | Not enough gas flow from propane tank | Open cylinder valve all the way, then S-L-O-W-L-Y open regulator valve to light burner |
| | Low gas level in propane tank, or tank is empty | Check gas level in propane tank, re-fill or exchange tank |
| Flame has gone out ⚠ WARNING ⚠ NEVER move or adjust your fryer while it is operating. Turn it off and let it cool first! | Low gas level in propane tank, or tank is empty | Check gas level in propane tank |
| | Too much wind | Check wind direction and set Fryer away from windy areas |
| Hissing or gurgling sounds coming through regulator hose assembly from tank to burner ⚠ WARNING ⚠ Do not use this appliance if Gas Leak Test fails. | Water in burner tube | Check burner tube for moisture, make sure burner is dry |
| | Damaged hose | Perform Gas Leak Test to check hose and all connections. |
| | Gas leak | See pages 12 - 13 and follow the instructions. |

FREQUENTLY ASKED QUESTIONS & SOME HELPFUL TIPS:

1. Batter and food are sticking to the basket.

Very often the first batch results in some food particles sticking to the basket. To reduce this from occurring, leave the baskets submerged in the oil during the heat up period. Once oil temperature reaches 300°F, remove the baskets from the oil and set them on the drain bar.

2. How do I keep my cooking temperature steady?

You must constantly monitor the thermometer and make minor adjustments to the regulator valve until a steady frying temperature is achieved. That is usually attained during the second batch. As the cooking process continues, a steady frying temperature can be maintained with the burner flame reduced to a lower setting.

3. What kind of filter do I use when I drain my used cooking oil?

A coffee filter or several layers of cheesecloth will help to remove any particles and crumbs, or you can use a screen sieve.

4. Is it safe to store my used cooking oil?

During the storage period bacteria will form on poultry, fish or animal fats remaining in the oil. This bacteria is quickly killed when the oil is re-heated. However, prior to using again, we recommend that you smell the cooking oil. If it smells unpleasant or rancid, discard properly and use new cooking oil.

HAVE ANY QUESTIONS/COMMENTS/CONCERNS?

We would love to hear from you. Please contact us at:

1-800-864-6194 • Monday - Friday • 8am to 5pm CST.

Barbour International, Inc. • 101 Cypress Way • Brandon, MS 39042

www.thebayou.com

BAYOU® FRYER ACCESSORIES



Basket Dimensions:
11" x 5.5" x 4.25"

Stainless Steel
Basket

700-186

4-Gal. Bayou® Fryer Basket



Basket Dimensions:
7.5" x 11" x 3.5"

Stainless Steel
Basket

700-182

2.5-Gal. Bayou® Fryer Basket



Basket Dimensions:
13" x 5.75" x 5.55"

Stainless Steel
Basket

700-187

9-Gal. Bayou® Fryer Basket



Basket Dimensions:
12" x 11" x 4.5"

Stainless Steel
Basket

700-188

Bayou® Fryer Accessory Basket

Fits 4-Gal.
& 9-Gal. Fryer



700-185

Bayou® Fryer
Accessory Cart

Fits 4-Gallon Fryer

Stainless Steel



Stainless
Braided Hose

M5HPR-1

10 PSI Preset Regulator



5070

Bayou® Fryer Thermometer



5004

2.5 & 4-Gallon
Bayou® Fryer
Cover



5009

9-Gallon
Bayou® Fryer
Cover