



# User's Manual

**Refrigerator Freezer WHD-423FSS1(D)  
WHD-423FWW1**



Before using your product, please read this manual carefully and keep it for future reference.





# TABLE OF CONTENTS

---

STRUCTURE ILLUSTRATION .....	2
IMPORTANT SAFETY INSTRUCTIONS.....	3
INSTALLATION INSTRUCTION .....	3
OPERATING YOUR REFRIGERATOR .....	4-5
FREEZER COMPARTMENT OPERATION .....	5
CARE & MAINTENANCE .....	6
CHANGING THE REVERSIBLE DOOR.....	7-8
TROUBLESHOOTING GUIDE.....	9

	<b>DANGER</b>	
<b>DANGER</b> Risk of fire or explosion.Flammable refrigerant used. Do not use mechanical devices to defrost refrigerator. Do not puncture refrigerant tubing.		
<b>DANGER</b> Risk of fire or explosion.Flammable refrigerant used.To be repaired only by trained service personnel. Do not puncture refrigerant tubing.		

	<b>CAUTION</b>	
<b>CAUTION</b> Risk of fire or explosion.Flammable refrigerant used.Consult repair manual/ owner's guide before attempting to service this product. All safety precautions must be followed.		
<b>CAUTION</b> Risk of fire or explosion.Dispose of property in accordance with federal or local regulations. Flammable refrigerant used.		
<b>CAUTION-</b> Risk of fire or explosion due to puncture of refrigerant tubing ;Follow handling instructions carefully. Flammable refrigerant used.		

# Main Components

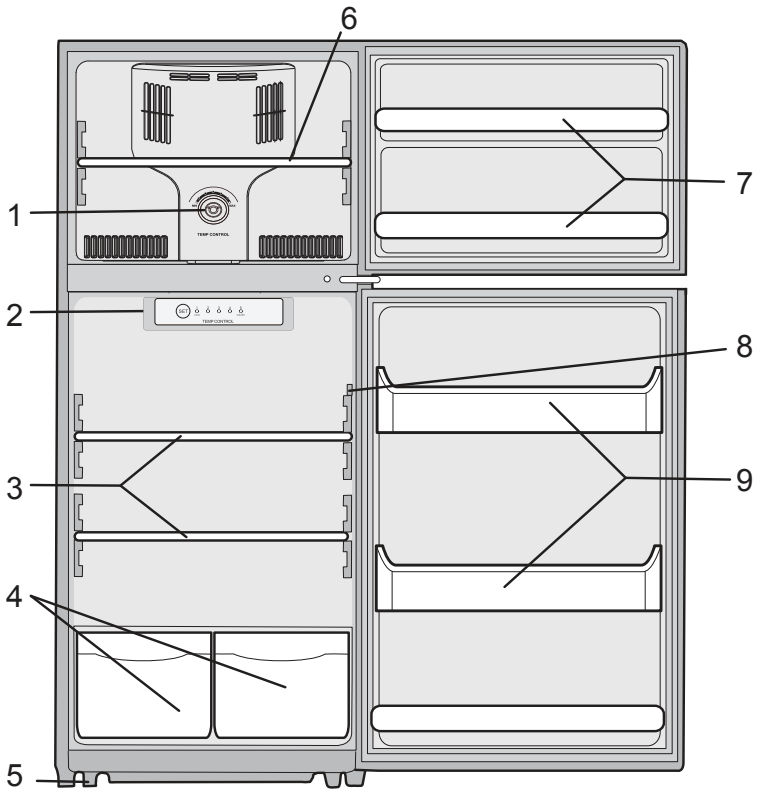

- 1 Freezer temperature control knob
- 2 Refrigerator temperature control
- 3 Refrigerator Compartment shelf
- 4 Vegetable Bin
- 5 Adjustable Feet
- 6 Freezer Compartment Shelf
- 7 Freezer Door Rail
- 8 Lamp Switch
- 9 Simple Rack

PS: If we change some small parts of the refrigerator , it is for you to use it more conveniently. Sorry for no giving notice.

# Important Safety Instructions



## WARNING

To reduce the risk of fire, electrical shock, or injury follow these basic precautions when using your refrigerator.

- **DANGER:** Risk of child entrapment. To avoid the possibility of child entrapment, please take the following precautions before you dispose of your refrigerator.
  - Remove all doors.
  - Leave shelves in place so children may not easily climb in.
  - Never allow children to play with, operate, or crawl inside the refrigerator.
- Do not store or use gasoline or any flammable vapors and liquids in the vicinity of this refrigerator.
- All refrigeration products contain refrigerants, which under the guidelines of federal law must be removed before disposal. It is the consumer's responsibility to comply with federal and local regulations when disposing of this product.

## Installation Instructions

### Before Using Your Refrigerator

- Remove the exterior and interior packing.
- Before connecting the refrigerator to the power source, let it stand upright for approximately 4 hours. This will reduce the possibility of a malfunction in the cooling system from improper handling during transportation.
- Clean the interior surface with lukewarm water using a soft cloth.

### Location

- Do not recess or build-in. This appliance is designed to be free standing only.
- Allow 5 inches clearance space between the back and sides of the refrigerator, which allows the proper air ventilation.
- **Avoid Installation:**
  - On weak surfaces unable to support refrigerator when fully loaded.
  - In direct sunlight and sources of heat (stove, heater, radiator, etc.). Ambient temperature below 50°F or above 85°F will hinder the performance of this appliance.
  - In moist areas.
  - In garage. **This unit is not designed for any type of outside installation.**
  - In moving vehicle. **This unit is not designed to be installed in an RV or used with an inverter. This unit is intended for household use only.**

### Installing Your Refrigerator

- Adjust the leveling feet to keep the refrigerator level.
- Plug the refrigerator into dedicated, properly installed-grounded wall outlet. Do not under any circumstances cut or remove the third (ground) prong from the power cord.
- After plugging the appliance into a wall outlet, turn the unit on and allow the unit to cool down for 24 hours before placing food in the refrigerator or freezer compartment.

## Electrical Connection



### WARNING

**Improper use of the grounded plug can result in the risk of electrical shock. If the power cord is damaged, have it replaced by an authorized service center.**

This refrigerator should be properly grounded for your safety. The power cord of this refrigerator is equipped with a three-prong plug which mates with standard three prong wall outlets to minimize the possibility of electrical shock.

Do not, under any circumstances, cut or remove the third ground prong from the power cord supplied.

This refrigerator requires a standard 115/120 Volt A.C. ~/60Hz electrical outlet with three-prong ground.

This refrigerator is not designed to be used with an inverter.

The cord should be secured behind the refrigerator and not left exposed or dangling to prevent accidental injury.

Never unplug the refrigerator by pulling the power cord. Always grip the plug firmly and pull straight out from the receptacle.

Do not use an extension cord with this appliance. If the power cord is too short, have a qualified electrician or service technician install an outlet near the appliance. Use of an extension cord can negatively affect the performance of the unit.

## Operating Your Refrigerator

### Temperature Control

The temperature control is located inside the refrigerator and in the freezer compartment on some models. The temperature is factory preset to provide satisfactory food storage temperatures. However, the temperature control is adjustable to provide a range of temperatures for your personal satisfaction.

To adjust the temperature colder in the refrigerator compartment, press the SET button on the control panel so that the display light shifts to a higher number. "1" is the warmest setting and "5" is the coldest. To adjust the temperature colder in the freezer compartment, move the Freezer Control knob towards the maximum setting. After each movement of either control, allow 24 hours for the unit to adjust. If the unit is still not cold enough, repeat until desired temperature is achieved.

To adjust the temperature warmer in the refrigerator compartment, press the SET button on the control panel so that the display light shifts to a lower number. To adjust the temperature warmer in the freezer compartment, move the Freezer Control knob towards the minimum setting. After each movement of either control, allow 24 hours for the unit to adjust. If the unit is still not warm enough, repeat until desired temperature is achieved.

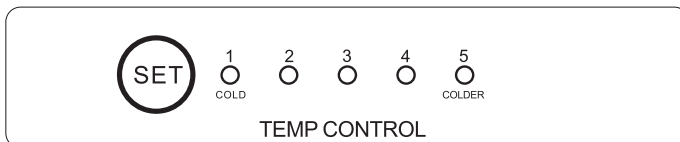

**NOTE**

If the unit is unplugged or loses power; you must wait 3 to 5 minutes before restarting the unit. If you attempt to restart before this time delay, the refrigerator may not start.

**Replacing the Interior Light**

Before removing the light bulb, turn the refrigerator temperature control to the “1” position. Then unplug the electrical cord from the wall outlet. Failure to do so may result in electrical shock or personal injury. Replace the old bulb with a new bulb of the same wattage and size.

## Freezer Compartment Operation

**Temperature Control**

Your refrigerator has one control for regulating the temperature in the freezer compartment. The freezer temperature control is located on the freezer compartment's interior back panel. For the best performance, leave the freezer control at the midpoint and adjust the refrigerator compartment temperature control. Adjust the freezer control one increment at a time until the desired temperature is reached.

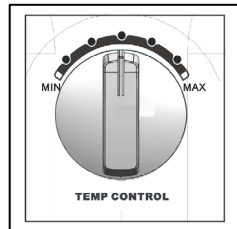
**NOTE**

Do not store canned foods or food stored in glass containers in the freezer compartment.

**The Freezer Compartment**

This compartment is designed for the long-term storage of frozen food. The storage life of frozen foods varies and the recommended storage time should not be exceeded. Place frozen food into the freezer as quickly as possible after purchase. If there are instructions on the packet, carefully follow these instructions regarding storage times.

# Care and Maintenance

## Cleaning Your Refrigerator

- Disconnect the electrical unit from the wall outlet.
- Clean interior and parts with a cloth soaked in lukewarm water and baking soda solution. A solution of 2 tablespoons baking soda to a quart of water will clean and neutralize odors. Rinse and wipe dry.
- Be sure to keep the door gasket (seal) clean to keep the unit running efficiently.
- The outside of the refrigerator should be cleaned with a warm damp cloth and mild detergent. Do not use harsh or abrasive cleaners.
- Never clean refrigerator parts with flammable fluids. The fumes can create a fire hazard.

## Vacation Time

- For long vacations, remove all food. Then, unplug the electrical cord from the wall outlet.
- Clean the interior and leave doors open to avoid possible odor or mold formation.
- Use extreme caution in the case of children. The unit should not be accessible to child's play.

## Moving Your Refrigerator

- Disconnect the electrical cord from the wall outlet.
- Remove all the food and securely tape down all loose items such as shelves, drawers, and doors.
- Be sure the refrigerator stays in the upright position during transportation.







## Energy Saving Tips

- The refrigerator should be located in the coolest area of the room, away from heat producing appliances or heating ducts, and out of the direct sunlight.
- Let hot foods cool to room temperature before placing in the refrigerator.
- Be sure to wrap foods properly, and wipe containers dry before placing them in the refrigerator. This cuts down on frost build-up inside the refrigerator.
- Organize and label food to reduce door openings and extended searches



# Changing the Reversible Door

Before reversing the door swing, ensure the appliance is unplugged and empty. Provide additional support for the doors while hinges are being removed. Do not depend on the door magnets to hold the door in place. It is recommended that two people perform this task. DO NOT lay the appliance completely flat as this may damage the coolant system.

**Door parts**

	Top hinge		Bottom right hinge
	Top hinge washer		Right pin assembly (2)
	Middle hinge washer		
	Middle hinge		

**Included parts**

	Left pin assembly (2)
	Bottom left hinge

## Step 1

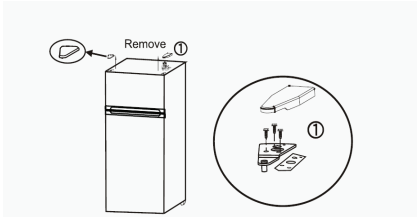

Remove top hinge cover. Unscrew and remove the top hinge and top hinge washer. Reserve the screws.

## Step 2

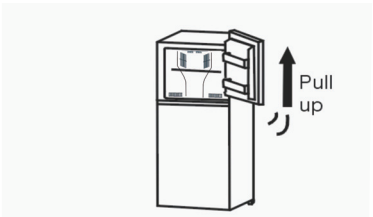

Lift the freezer door up and away from the appliance.

## Step 3

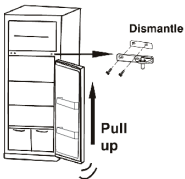

Unscrew and remove the middle hinge and middle hinge washer. Reserve the screws. Lift the refrigerator door up and away from the appliance.

## Step 4

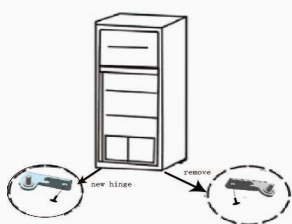

Unscrew and remove the bottom right hinge. Reserve the screws. Remove screw covers from opposite corner (left) and cover exposed holes (right). Attach bottom left hinge with the reserved screws.



## Step 5

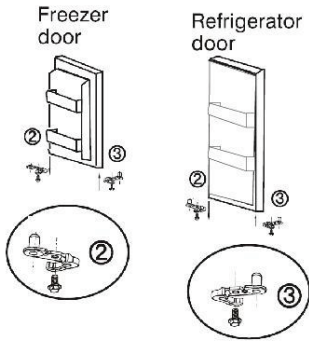

Remove right pin assemblies from the bottom of the freezer and refrigerator doors. On the opposite side, attach the replacement pin assemblies (located in the plastic bag with the Use and Care Manual) with a screwdriver. Note: You must re-use the screws from the pin assemblies that are removed in this step when attaching the new assemblies.

## Step 6

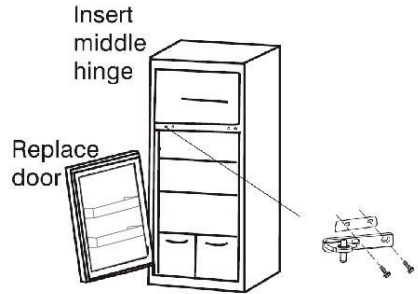

Place the refrigerator door on the bottom left hinge. Ensure the door is aligned horizontally and vertically. Attach middle hinge to top (left) of refrigerator door, attach washer to the back of hinge, align with holes and affix to middle beam with reserved screws. Fasten with screwdriver (not included).

## Step 7



Place the freezer door on the middle hinge. Ensure that the door is aligned horizontally and vertically, and that the gasket seals on all sides before attaching the top hinge. Attach the top hinge and replace the hinge cover.

# Troubleshooting Guide

You can solve many common refrigerator problems easily, saving you the cost of a possible service call. Try the suggestions below to see if you can solve the problem before calling for service.

<b><i>Problem</i></b>	<b><i>Possible Causes</i></b>
<b>Refrigerator does not operate</b>	<ul style="list-style-type: none"> <li>• Refrigerator is unplugged.</li> <li>• The circuit breaker is tripped/ fuse blown.</li> </ul>
<b>Compressor turns on and off</b>	<ul style="list-style-type: none"> <li>• The room temperature is warmer than normal</li> <li>• Door is left open or is frequently opened.</li> <li>• The refrigerator does not have the correct clearances.</li> <li>• The refrigerator has recently been disconnected for a period of time.</li> </ul>
<b>Refrigerator compartments are too warm</b>	<ul style="list-style-type: none"> <li>• Temperature control is not set correctly.</li> <li>• Door is left open or is frequently opened.</li> <li>• The door gasket does not seal properly.</li> <li>• A large amount of warm or hot food was stored recently. Wait for the refrigerator to reach its selected temperature.</li> <li>• The refrigerator has recently been disconnected for a period of time.</li> </ul>
<b>Vibrating or rattling (slight vibration is normal)</b>	<ul style="list-style-type: none"> <li>• Leveling legs need adjusting</li> <li>• Refrigerator is placed on an uneven or weak surface.</li> <li>• The refrigerator is touching the wall. Re-level the refrigerator and move it away from the wall.</li> </ul>
<b>Temperature of external refrigerator surface is warm</b>	<ul style="list-style-type: none"> <li>• The exterior refrigerator walls can be as much as 30°F warmer than room temperature.</li> <li>• This is normal while the compressor works to transfer heat from inside the refrigerator cabinet.</li> </ul>
<b>Moisture collects inside the refrigerator</b>	<ul style="list-style-type: none"> <li>• Door is left open or is frequently opened.</li> </ul>
<b>Moisture forms on outside of refrigerator</b>	<ul style="list-style-type: none"> <li>• Is normal in hot and humid weather. Air carries moisture into the refrigerator when doors are opened.</li> </ul>
<b>Bubbling or gurgling sounds (like boiling water)</b>	<ul style="list-style-type: none"> <li>• This is the normal sound of refrigerant (used to cool refrigerator) circulating throughout the system.</li> </ul>
<b>Popping or cracking sounds when compressor comes on</b>	<ul style="list-style-type: none"> <li>• This is normal. Metal parts undergo expansion and contraction, like hot water pipes. The sound will level off or disappear as refrigerator runs.</li> </ul>
<b>The door will not close properly</b>	<ul style="list-style-type: none"> <li>• The refrigerator is not on a level surface.</li> <li>• The gasket is dirty.</li> <li>• The storage basket is out of position.</li> </ul>

For more information, please visit our website  
[www.midea.com](http://www.midea.com)

