

# INSTALLATION INSTRUCTIONS

## Installation Overview

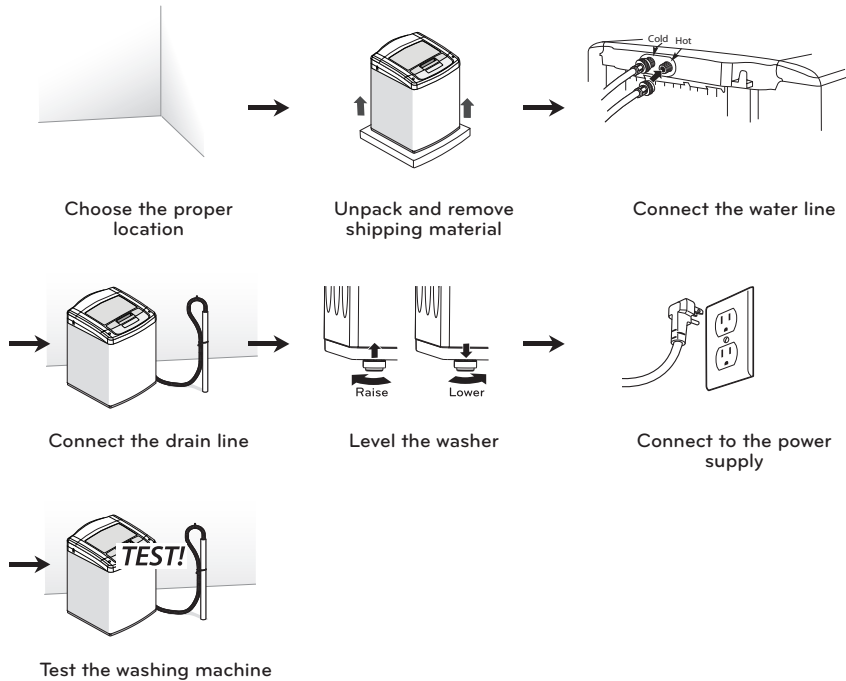

### ⚠ WARNING

- The washer is heavy! Two or more people are required when moving and unpacking the washer. Failure to do so can result in back or other injury.
- Store and install the washer where it will not be exposed to temperatures below freezing or exposed to outdoor weather conditions. Failure to follow this warning can cause serious injury, fire, electric shock, or death.
- Properly ground the washer to conform with all governing codes and ordinances. Failure to follow this warning can cause serious injury, fire, electric shock, or death.
- To reduce the risk of electric shock, do not install the washer in humid spaces. Failure to follow this warning can cause serious injury, fire, electric shock, or death.
- To ensure proper air flow, do not block the large opening on the bottom of the washer with carpeting or other materials.
- Do not remove the ground prong. Do not use an adapter or extension cord. Plug into a grounded 3-prong outlet. Failure to follow this warning can cause serious injury, fire, electric shock, or death.

## CHOOSE THE PROPER LOCATION

Install the washing machine on a solid floor that is strong and rigid enough to support the weight of the washing machine, even when fully loaded, without flexing or bouncing. If the floor has too much flex, you may need to reinforce it to make it more rigid. If the floor is not solid, it may cause severe vibration and noise.

## POWER OUTLET

- The power outlet must be within 60 in. (1.5 m) of either side of the washer.
- The appliance and outlet must be positioned so that the plug is easily accessible.
- Do not overload the outlet with more than one appliance.
- The outlet must be grounded in accordance with current wiring electric codes and regulations.
- Time-delay fuse or circuit breaker is recommended.

**NOTE:** It is the personal responsibility and obligation of the product owner to have a proper outlet installed by a qualified service technician.

## FLOORING

- To minimize noise and vibration, the washer **MUST** be installed on a solidly constructed floor.
- Allowable slope under the entire washer is a maximum 1 in. difference from side to side or from front to back.
- Installing on carpeting and soft tile surfaces is not recommended.
- Never install the washer on a platform or weakly supported structure.

**NOTE:** The washer must be installed on firm flooring to minimize vibration during the spin cycle. Concrete flooring is best, but a wood floor is sufficient, provided it is built to FHA standards. The washer should not be installed on rugs or exposed to weather.

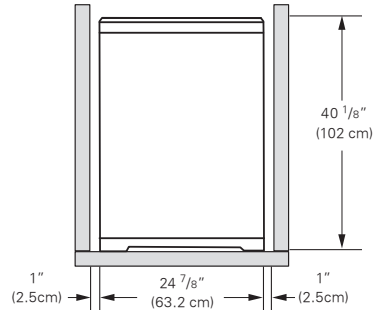

To ensure sufficient clearance for water lines and airflow, allow minimum clearances of at least 1 in. (2.5 cm) at the sides and 4 in. (10 cm) behind the unit. Be sure to allow for wall, door, or floor moldings that may increase the required clearances.

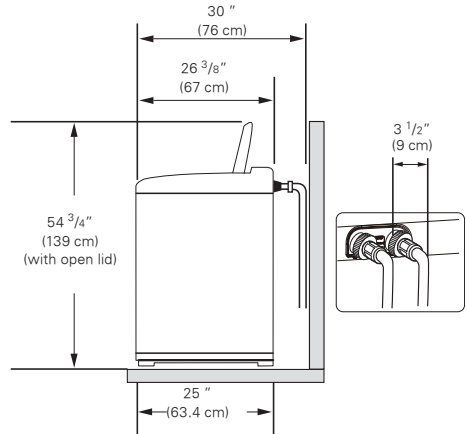

Minimum vertical space from floor to overhead shelves, cabinets, ceilings, etc., is 56 in.

**NOTE:** If overhead space is especially tight, using the fold-down lid handle can reduce the minimum vertical clearance by approximately 1 in.

## UNPACK AND REMOVE SHIPPING MATERIAL

1. After removing the carton and shipping material, lift the washer off the foam base. Make sure the plastic tub support comes off with the base and is not stuck to the bottom of the washer.

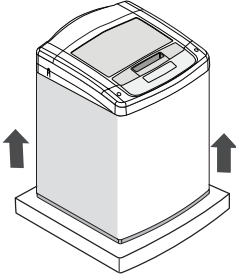

If you must lay the washer down to remove the base packaging materials, always protect the side of the washer and lay it carefully on its side. DO NOT lay the washer on its front or back.

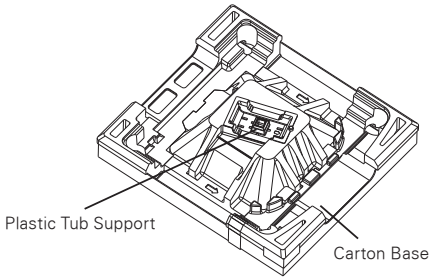

2. Save the foam block containing the Owner's Manual, parts and laundry product samples for future use. If the washer must be moved in the future, the foam block will help prevent damage to the washer during transportation.

**NOTE:** To prevent damage, do not remove the foam block until the washer is at the final location.

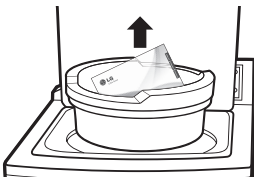

3. Unfasten the power cord from the back of the washer.

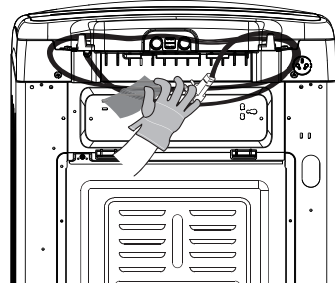

## TOOLS YOU WILL NEED

- Adjustable Pliers

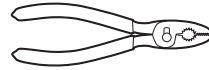

- Carpenter's Level



## CONNECT THE WATER LINES

- LG recommends the use of LG hoses. Any leaking, property damage, or damage to the washing machine caused by an improper installation or by the use of non-LG hoses is not covered under the terms of the LG warranty and is the sole responsibility of the customer and/or an installer. For your safety, and for extended product life, we recommend using high-quality LG components. LG is not responsible for product malfunction or damage caused by the use of separately purchased non-LG parts. Contact LG Customer Service for assistance in buying hoses: 1-800-243-0000.
- Water supply pressure must be between 14.5 psi and 116 psi (100 - 800 kPa). If the water supply pressure is more than 116 psi, a pressure reducing valve must be installed.
- Periodically check the hose for cracks, leaks, and wear, and replace the hose if necessary.
- Make sure that the water lines are not stretched, pinched, crushed, or kinked.
- The washer should never be installed or stored in a location subject to freezing temperatures. Damage to the water lines and internal mechanisms of the washer can result. If the washer was exposed to freezing temperatures prior to installation, allow it to stand at room temperature for several hours before use and check for leaks prior to operation.

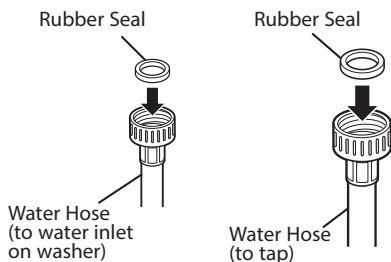

1. Inspect the threaded fitting on each hose and make sure there is a rubber seal in place in both ends.

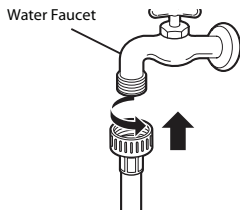

### ⚠ WARNING

- **Do not reuse old hoses.** Only use new hoses when you install the washing machine. Old hoses could leak or burst causing flooding and property damage.

2. Connect the water supply hoses to the HOT and COLD water faucets tightly by hand and then tighten another 2/3 turn with pliers.

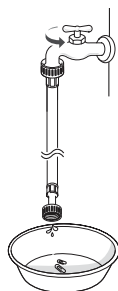

### ⚠ WARNING

- **Do not overtighten.** Damage to the coupling can result.

3. Always run a gallon or two of water through each inlet hose to flush dirt, scale and other debris out of the water lines. Doing so will help prevent future problems with clogged filter screens, and will also allow you to verify which hose is hot and which is cold.

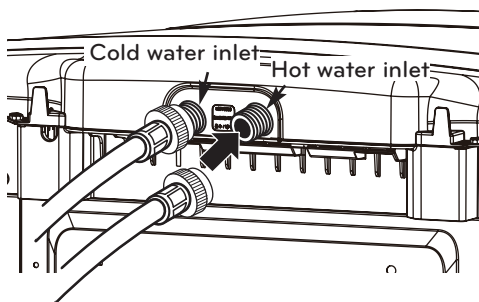

### ⚠ WARNING

- **Do not overtighten the hoses.** Overtightening can damage the valves resulting in leaking and property damage.

4. Attach the hot water line to the hot water inlet (orange) on the back of the washer. Attach the cold water line to the cold water inlet (blue) on the back of the washer. Tighten the fittings securely. Turn ON both faucets all the way and check for leaks at both ends of the hoses.

**NOTE:** Be careful not to cross-thread the hose fittings. This will damage the valve and could result in property damage from leaks.

## CONNECT THE DRAIN HOSE

- The drain hose should always be properly secured. Failure to properly secure the drain hose can result in flooding and property damage.
- The drain must be installed in accordance with any applicable local codes and regulations.
- Make sure that the drain hose is not stretched, pinched, crushed, or kinked.

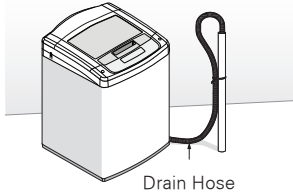

## OPTION 2: LAUNDRY TUB

Bend the end of the drain hose to the desired shape and support it on the edge of the laundry tub. Use the tie strap to secure the drain hose in place.

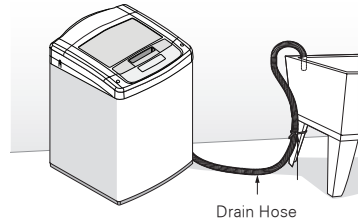

## OPTION 1: STANDPIPE

Bend the outlet end of the drain hose to form a U shape. Insert the end of the drain hose into the drain. If the drain is large enough for the flange on the hose to fit inside, then do not insert the flange more than 1-2 inches into the drain. Use the tie strap included with the installation materials in the foam block in the tub to secure the drain hose to the drain.

If the water valves and drain are built into the wall, fasten the drain hose to one of the water hoses with the tie strap (ribbed side on inside).

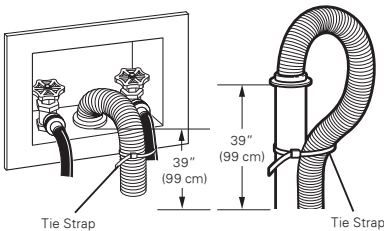

If your drain is a standpipe, fasten the drain hose to the standpipe with the tie strap provided.

### NOTE:

- Normal height of the end of the hose should be approximately 35" - 47" (0.9 - 1.2 m) from the floor.
- Do not install the end of the drain hose lower than 29.5 in (75 cm) or higher than 96 in. (243.8 cm) above the bottom of the washer or more than 60 in. (152.4 cm) away from the washer.
- Never seal the drain hose to the drain with methods such as tape. If no air gap is present, water can be siphoned out of the tub resulting in poor wash/rinse performance or clothing damage.

## LEVEL THE WASHER

The tub of your new washer spins at very high speeds. To minimize vibration, noise, and unwanted movement, the floor must be a level, solid surface.

### NOTE:

- Adjust the leveling feet only as far as necessary to level the washer. Extending the leveling feet more than necessary can cause the washer to vibrate.
- Before installing the washer, make sure that the floor is clean, dry and free of dust, dirt, water and oil so the washer feet cannot slide easily. Feet that move or slide on the floor can contribute to excessive vibration and noise due to poor contact with the floor.

All four feet must rest solidly on the floor. Attempt to rock the washer from corner to corner to make sure that all four feet are in firm contact with the floor.

1. Position the washer in its final location, taking special care not to pinch, strain, or crush the water and drain lines. Place a level across the top of the washer.

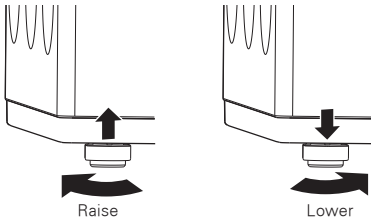

2. Adjust the leveling feet. Turn clockwise to raise the washer or counterclockwise to lower it.

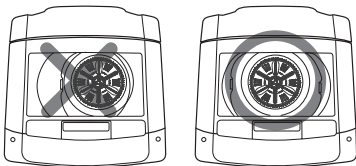

3. To make sure that the washer is properly level, open the lid and look from above to see if the tub is centered. If the tub is NOT centered (as shown in the drawing with the X through it), readjust the front feet. If you have a level, check your washer with the level.

- To check if the washer is level from side to side, place a level on the back edge of the lid.
- To check if the washer is level front to back, place a level at the side of the washer on the edge where

the cabinet side meets the top cover. Do not place the level on the top of the lid. Using these surfaces will result in the washer being unlevel.

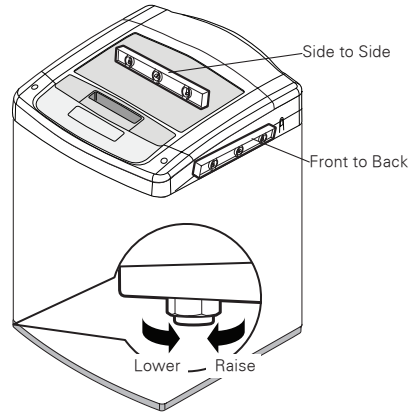

- If the leveling feet have been adjusted as much as possible and the washer is still not level, use the risers to lift the back leg(s) of the washer to help level it. To use, press the riser onto the leg. You can stack up to three risers under one leg.

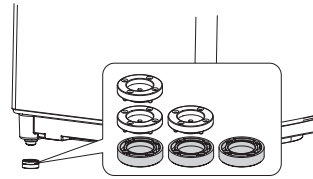

### ⚠ WARNING

- Using the washing machine without leveling it may result in malfunction caused by the production of excess vibration and noise.
- **Use the leveling feet only when you level the washing machine.** If you raise the leveling feet unnecessarily, it may cause abnormal vibration of the washing machine.

## CONNECT TO THE POWER SUPPLY

The washer should be plugged into a 120-VAC, 60-Hz grounded 3-prong outlet. Plug in the washer. Improper connection of the equipment-grounding conductor can result in risk of electric shock. Check with a qualified electrician or service technician if you are in doubt as to whether the appliance is properly grounded. Do not modify the plug provided with the appliance. If it does not fit the outlet, have a proper outlet installed by a qualified electrician. Failure to follow these warnings can cause serious injury, fire, electrical shock, or death.

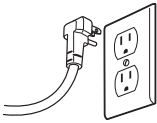

### ⚠️ WARNING

- **The power outlet must be within 60 inches (1.5 m) of either side of the washer.**
- **The appliance and outlet must be positioned so that the plug is easily accessible.**
- **Do not overload the outlet with more than one appliance.**
- **The outlet must be grounded in accordance with current wiring codes and regulations.**
- Time-delay fuse or circuit breaker is recommended.
- It is the personal responsibility and obligation of the product owner to have a proper outlet installed by a qualified electrician.
- **Do not use a worn or damaged power cord or power plug. Replace or repair it immediately.** Failure to do so may result in death, fire, electric shock, or malfunction.
- **Do not modify the power cord and take care not to damage it when installing or moving the washing machine.** Failure to do so may result in death, fire, electric shock, or malfunction.
- **Make sure that the washing machine is grounded.**
- **Connect this washing machine to a grounded outlet conforming to the rating prior to use.** Failure to do so may result in fire, electric shock, or malfunction.
- **Do not use adaptors or extension cords.** The washing machine should always be plugged into its own individual electrical outlet which has a voltage rating that matches the rating plate. Failure to do so may result in fire, electric shock or disorder.
- **Do not damage or cut off the ground prong of the power cord.** Doing so may cause death, fire, electric shock, or product malfunction.

## TEST THE WASHER

Check if the washing machine is properly installed and run a test cycle.

1. Load the washing machine with 6 pounds of laundry (approximately 6 thick bath towels).
2. Press the POWER button.
3. Press the RINSE + SPIN button.
4. Press the START/PAUSE button.
  - The wash cycle starts.
5. Check if water is supplied, that the machine does not rock or vibrate excessively, and that it drains well during the spin cycle.
  - If water leaks during water supply, see page 14, Connect the Water Lines to connect them properly.
  - If the washing machine rocks and vibrates excessively, see page 16, Level the Washer to level it again.
  - If the drain does not work, see page 15, Connect the Drain Hose to install the hose properly.