

OPERATION

Gas Surface Burners

Before Use

Read all instructions before using.

Make sure that all burners are properly placed.

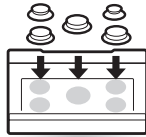

Make sure that all grates are properly placed before using the burner.

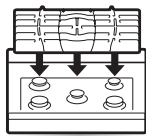

CAUTION

Do not operate the burner for an extended period of time without cookware on the grate.

The finish on the grate may chip without cookware to absorb the heat.

Make sure the burners and grates are cool before touching them, or placing a pot holder, cleaning cloth, or other materials on them.

Touching grates before they cool down may cause burns.



CAUTION

WHAT TO DO IF YOU SMELL GAS

- Open windows.
- Do not try to light any appliance.
- Do not touch any electrical switch.
- Do not use any phone in your building.
- Immediately call your gas supplier from a neighbor's phone. Follow the gas supplier's instructions.
- If you cannot reach your gas supplier, call the fire department.

NOTE

Electric spark igniters from the burners cause a clicking noise. All the spark igniters on the cooktop will activate when igniting just one burner.

Burner Locations

Your gas range cooktop has four or five sealed gas burners, depending on the model. These can be assembled and separated. Follow the guide below.

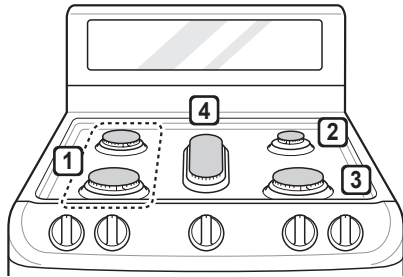

LDG4315 / LDG4313

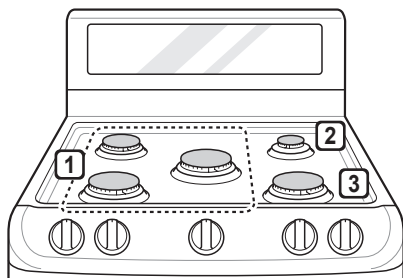

LDG4311

1 Medium and Large Burner

The medium and large burners are the primary burners for most cooking. These general purpose burners can be turned down from **Hi** to **Lo** to suit a wide range of cooking needs.

2 Small Burner

The smallest burner is used for delicate foods such as sauces or foods that require low heat for a long cooking time.

3 Extra Large Burner

The extra large burner is the maximum output burner. Like the other four burners, it can be turned down from **Hi** to **Lo** for a wide range of cooking applications. This burner is also designed to quickly bring large amounts of liquid to a boil. It can be used with cookware 10 inches or larger in diameter.

4 Oval Burner (LDG4315 / LDG4313)

The center, oval burner is for use with a griddle or oval pots.

Using the Gas Surface Burners

- 1 Be sure that all of the surface burners and grates are placed in the correct positions.
- 2 Place cookware on the grate.
- 3 Push the control knob and turn to the **Lite** position.

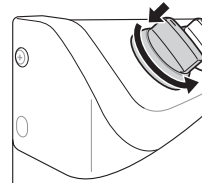

The electric spark ignition system makes a clicking noise.

- 4 Turn the control knob to control the flame size.

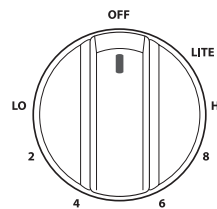

CAUTION

Do not attempt to disassemble or clean around any burner while another burner is on. All the burners spark when any burner is turned to **Lite**. An electric shock may result causing you to knock over hot cookware.

Setting the Flame Size

Watch the flame, not the knob, as you reduce heat. Match the flame size on a gas burner to the cookware being used for fastest heating.

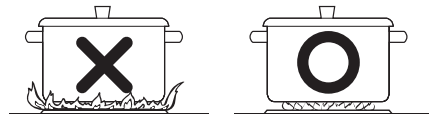

CAUTION

Never let the flames extend up the sides of the cookware.

NOTE

- The flames on the surface burners may burn yellow in the presence of high humidity, such as a rainy day or a nearby humidifier.
- After LP gas conversion, flames can be bigger than normal when you put a pot on the surface burner.

In Case of Power Failure

In case of a power failure, you can light the gas surface burners on your range with a match.

Surface burners in use when an electrical power failure occurs will continue to operate normally.

- 1 Hold a lit match to the burner, then push in the control knob.
- 2 Turn the control knob to the **Lo** position.

CAUTION

Use extreme caution when lighting burners with a match. It can cause burns and other damage.

Range-Top Cookware

| | |
|-------------------------|---|
| Aluminum | Medium-weight cookware is recommended because it heats quickly and evenly. Most foods brown evenly in an aluminum skillet. Use saucepans with tight fitting lids when cooking with minimum amounts of water. |
| Cast-Iron | If heated slowly, most skillets will give satisfactory results. |
| Stainless Steel | This metal alone has poor heating properties and is usually combined with copper, aluminum or other metals for improved heat distribution. Combination metal skillets work satisfactorily if they are used with medium heat as the manufacturer recommends. |
| Enamelware | Under some conditions, the enamel of this cookware may melt. Follow cookware manufacturer's recommendations for cooking methods. |
| Glass | There are two types of glass cookware. Those for oven use only and those for top-of-range cooking. |
| Heatproof Glass Ceramic | Can be used for either surface or oven cooking. It conducts heat very slowly and cools very slowly. Check cookware manufacturer's directions to be sure it can be used on gas ranges. |

Using a Wok

If using a wok, use a 14-inch or smaller flat-bottomed piece of wok. Make sure that the wok bottom sits flat on the grate.

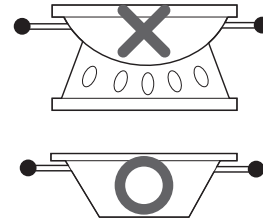

Use flat-bottomed wok

CAUTION

Do not use a wok support ring. Placing the ring over the burner or grate may cause the burner to work improperly, resulting in carbon monoxide levels above allowable standards. This can be hazardous to your health.

Using Stove-Top Grills

Do not place stove-top grills on the burner.



CAUTION

Do not use stove top grills on the surface burners. Using a stove top grill on the surface burner will cause incomplete combustion and can result in exposure to carbon monoxide levels above allowable current standards. This can be a health hazard.

Using the Griddle (on some models)

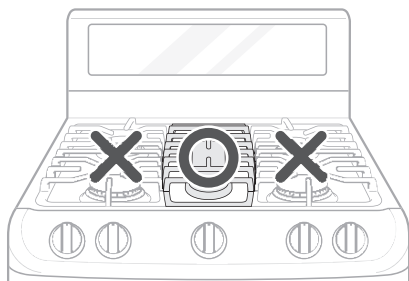

The non-stick coated griddle provides an extra-large cooking surface for meats, pancakes or other food usually prepared in a frying pan or skillet.

NOTE

It is normal for the griddle to become discolored over time.

How to Place the Griddle: The griddle can only be used with the center burner. The griddle must be properly placed on the center grate, as shown below.

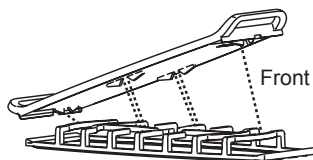

CAUTION

- Do not remove the center grate when using the griddle.
- Do not remove the griddle plate until the cooktop grates, surfaces and griddle plate have completely cooled.
- The griddle plate on the cooktop may become very hot when using the cooktop, oven or broiler systems. Always use oven mitts when placing or removing the griddle plate.

Preheat the griddle according to the guide below and adjust for the desired setting.

| Type of Food | Preheat Conditions | Cook Setting |
|-------------------------|--------------------|--------------|
| Warming Tortillas | - | 5 (MED) |
| Pancakes | HI 5 min. | HI |
| Hamburgers | HI 5 min. | HI |
| Fried Eggs | HI 5 min. | HI |
| Bacon | HI 5 min. | HI |
| Breakfast Sausage Links | HI 5 min. | HI |
| Hot Sandwiches | HI 5 min. | HI |

NOTE

After cooking on the griddle for an extended period, adjust the griddle temperature settings as the griddle retains heat.

IMPORTANT NOTES

- Avoid cooking extremely greasy foods as grease spillover can occur.
- The griddle can become hot when surrounding burners are in use.
- Do not overheat the griddle. This can damage the non stick coating.
- Do not use metal utensils that can damage the griddle surface. Do not use the griddle as a cutting board.
- Do not place or store items on the griddle.

The Oven

Before Use

Read all instructions before using.

Make sure the electrical power cord and the gas valve are properly connected.

Confirm the correct usage of the range for the type of food you will cook.

Make sure you know how to use the oven (temperature setting, time setting and recipe) for best results.

CAUTION

WHAT TO DO IF YOU SMELL GAS

- Open windows.
- Do not try to light any appliance.
- Do not touch any electrical switch.
- Do not use any phone in your building.
- Immediately call your gas supplier from a neighbor's phone. Follow the gas supplier's instructions.
- If you cannot reach your gas supplier, call the fire department.

Choose the upper or lower oven for proper cooking.

Use the upper oven to cook a small amount of food.

NOTE

If using an oven thermometer in the oven cavity, temperatures may differ from the actual set oven temperature with all modes.

In case of power failure, do not use the oven.

The oven and broiler cannot be used during a power outage. If the oven is in use when a power failure occurs, the oven burner shuts off and cannot be re-lit until power is restored. Once power is restored, you will need to reset the oven (or Broil function).

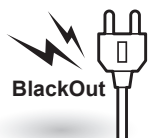

CAUTION

Do not attempt to operate the electric ignition during an electrical power failure.

Do not block, touch or place items around the oven vent during cooking.

Your oven is vented through ducts at the center above the burner grate. Do not block the oven vent when cooking to allow for proper air flow. Do not touch vent openings or nearby surfaces during any cooking operation.

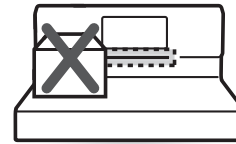

CAUTION

- Do not place plastic or flammable items on the cooktop. They may melt or ignite if left too close to the vent.
- Do not place closed containers on the cooktop. The pressure in closed containers may increase, which may cause them to burst.
- Metal items will become very hot if they are left on the cooktop, and could cause burns.
- Handles of pots and pans on the cooktop may become hot if left too close to the vent.

Do not cover racks or oven bottom with aluminum foil.



You may see condensation on the oven door glass.

As the oven heats up, the heated air in the oven may cause condensation to appear on the oven door glass. These water drops are harmless and will evaporate as the oven continues to heat up.

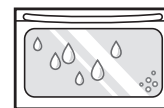

Control Panel Overview

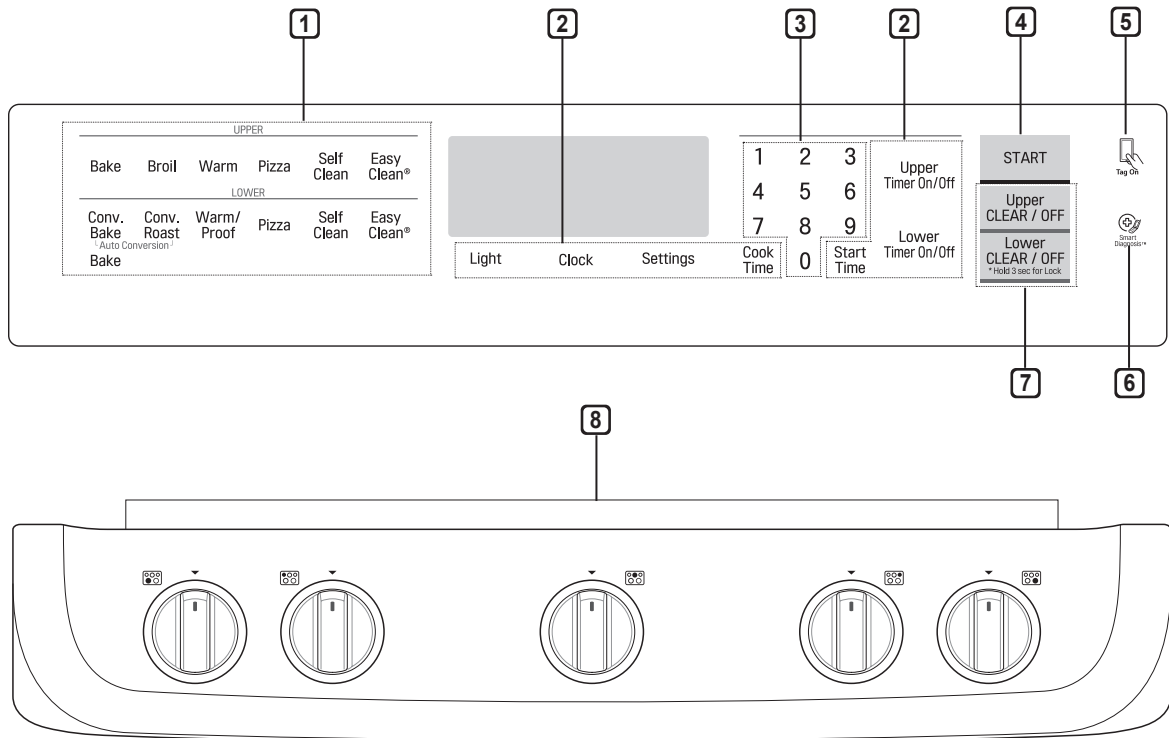

1 Oven Controls

2 Features

3 Number Keys

4 Start Key

5 NFC Tag On

6 Smart Diagnosis™

7 Clear Off / Lockout Key

8 Gas Surface Burners

Flashing Time

If the oven displays a flashing clock, touch **Clock** and reset the time, or touch any key to stop the flashing.

Changing Oven Settings

Clock

The clock must be set to the correct time of day in order for the automatic oven timing functions to work properly.

- 1 Touch **Clock**.
- 2 Touch the numbers to enter the time. For example, to set the clock for 10:30, touch the numbers: **1**, **0**, **3** and **0**.
- 3 Touch **Start**.

NOTE

- The time of day cannot be changed during a timed baking or self-clean cycle.
- To check the time of day when the display is showing other information, touch **Clock**.
- If no other keys are touched within 25 seconds of touching **Clock**, the display reverts to the original setting.
- If the display time is blinking, there may have been a power failure. Reset the time.

Oven Light

The interior oven light automatically turns on when the door is opened. Touch **Light** to manually turn the oven light on.

NOTE

The oven light cannot be turned on if the Self Clean function is active.

Minimum & Maximum Default Settings

All of the features listed have a minimum and a maximum time or temperature setting that can be entered into the control. A beep sounds each time a control key is touched.

Two short tones sound if the entry of the temperature or time is below the minimum or above the maximum setting for the feature.

| Feature | | min. Temp. / Time | max. Temp. / Time | Default |
|-------------|--------|--------------------------|--------------------------|---------------------------------|
| Clock | 12 Hr. | 1:00 Hr. / min. | 12:59 Hr. / min. | |
| | 24 Hr. | 0:00 Hr. / min. | 23:59 Hr. / min. | |
| Timer | 12 Hr. | 0:01 min. / sec. | 11:59 Hr. / min. | |
| | 24 Hr. | 0:01 min. / sec. | 11:59 Hr. / min. | |
| Cook Time | 12 Hr. | 0:01 Hr. / min. | 11:59 Hr. / min. | |
| | 24 Hr. | 0:01 Hr. / min. | 11:59 Hr. / min. | |
| Conv. Bake | | 300 °F / 150 °C | 550 °F / 285 °C | 350 °F (*325 °F) / 12 Hr. |
| Conv. Roast | | 300 °F / 150 °C | 550 °F / 285 °C | 350 °F (*325 °F) / 12 Hr. |
| Broil | | Lo 300 °F / 150 °C | Hi 400 °F / 204 °C | Hi / 3 Hr. |
| Bake | | 170 °F / 80 °C | 550 °F / 285 °C | 350 °F / 12 Hr. |
| Proof | | | | 12 Hr. |
| Pizza | | | | 12 Hr. |
| Warm | | | | 3 Hr. |
| Self Clean | | 2 Hr. | 4 Hr. | 3 Hr. |
| EasyClean® | | | | 15 min. (Upper) |
| | | | | 10 min. (Lower) |

* Using Auto Conversion

- Default cook mode times are without setting cook time.

Timer On/Off

The Upper or Lower Timer On/Off serves as an extra timer in the kitchen that beeps when the set time has run out. It does not start or stop cooking.

The Upper or Lower Timer On/Off feature can be used during any of the other oven control functions. The Upper and Lower Timer can be operated independently of each other.

For example to set 5 minutes

- 1 Touch **Upper Timer On/Off** or **Lower Timer On/Off** once.
0:00 appears and **Timer** flashes in the display.
- 2 Touch **5**.
0:05 appears in the display.
- 3 Touch **Timer On/Off** to start the Timer. The remaining time countdown appears in the display.

NOTE

If **Upper Timer On/Off** or **Lower Timer On/Off** is not touched, the timer returns to the time of day.

- 4 When the set time runs out, **End** shows in the display. The indicator tones sound every 15 seconds until **Upper Timer On/Off** or **Lower Timer On/Off** is touched.

NOTE

- If the remaining time is not in the display, recall the remaining time by touching **Upper Timer On/Off** or **Lower Timer On/Off**.
- Touch **Upper Timer On/Off** or **Lower Timer On/Off** twice to set the time in minutes and seconds.
- Touch **Upper Timer On/Off** or **Lower Timer On/Off** once to set the time in hours and minutes.

Cancelling the Timer

- 1 Touch **Upper Timer On/Off** or **Lower Timer On/Off** once.
The display returns to the time of day.

Settings

Touch the **Settings** key repeatedly to toggle through and change oven settings.

The **Settings** key allows you to

- set the hour mode on the clock (12 or 24 hours)
- enable/disable convection auto conversion
- adjust the oven temperature
- activate/deactivate the preheating alarm light
- set the beeper volume
- switch the temperature scale between Fahrenheit and Celsius

Setting the Hour Mode

The control is set to use a 12-hour clock. To reset the clock to 24-hour mode, follow the steps below.

- 1 Touch **Settings** once.
- 2 Touch **1** to toggle between a 12-hour and 24-hour clock.
- 3 Touch **Start** to accept the change.

Setting Convection Auto Conversion

When **Conv. Bake** and **Conv. Roast** are selected, Convection Auto Conversion automatically converts the standard recipe temperature entered to a convection temperature by subtracting 25 °F / 14 °C. This auto-converted temperature shows on the display. For example, select **Conv. Bake**, enter 350 °F, and 325 °F shows on the display after preheat.

Convection Auto Conversion is enabled by default. To change the setting, follow these instructions.

- 1 Touch **Settings** repeatedly until **Auto** appears in the display.
- 2 Touch **1** to disable or enable auto conversion.
- 3 Touch **Start** to accept the change.

Adjusting the Oven Thermostat

Your new oven may cook differently from the one it replaced. Use your new oven for a few weeks to become more familiar with it before changing the temperature settings. If after familiarizing yourself with the new oven, you still think that it is too hot or too cold, you can adjust the oven thermostat yourself.

NOTE

To begin, either raise or lower the thermostat 15 °F (8 °C). Try the oven with the new setting. If the oven still needs adjustment, raise or lower the thermostat again, using the first adjustment as a gauge. For example, if the adjustment was too much, raise or lower the thermostat 10 °F (5 °C). If the adjustment was not enough, raise or lower the thermostat 20 °F (12 °C). Proceed in this way until the oven is adjusted to your satisfaction.

- 1 Touch **Settings** repeatedly until **L_AJ** or **U_AJ** appears in the display.
- 2 Use the number keys to enter the number of degrees you want to adjust the oven thermostat.
- 3 Adjust the thermostat either up or down by touching **Settings** repeatedly to toggle between plus (+) or minus (-).
- 4 Touch **Start** to accept the change.

NOTE

- This adjustment does not affect the broiling or Self Clean temperatures. The adjustment is retained in memory after a power failure. The oven thermostat can be increased (+) or decreased (-) as much as 35 °F or 19 °C.
- Once the thermostat is increased or decreased, the display shows the adjusted temperature until it readjusts.

Turning the Preheat Alarm Light On/Off

When the oven reaches its set temperature, the preheating alarm light flashes until the oven door is opened.

You can activate or deactivate the preheating alarm light.

- 1 Touch **Settings** repeatedly until **PrE** appears in the display.
- 2 Touch **1** to turn the light on/off.
- 3 Touch **Start** to accept the change.

Adjusting the Beeper Volume

- 1 Touch **Settings** repeatedly until **Beep** appears in the display.
- 2 Touch **1** to select **Hi**, **Lo** or **Off**.
- 3 Touch **Start** to accept the change.



Selecting Fahrenheit or Celsius

Set the oven temperature display to show either Fahrenheit (°F) or Celsius (°C) units. The oven defaults to Fahrenheit unless changed by the user.

- 1 Touch **Settings** repeatedly until **Unit** appears in the display.
- 2 Touch **1** to select **F** (Fahrenheit) or **C** (Celsius).
- 3 Touch **Start** to accept the change.

Lockout

The Lockout feature automatically locks the oven door and prevents most oven from being turned on. It does not disable the timer and the interior oven light.

- 1 Touch and hold **Lower Clear/Off** for three seconds.
- 2 The lock melody sounds, **Loc** appears in the display and the lock  blinks in the display.
- 3 Once the oven door is locked, the lock  indicator stops blinking and remains on.
- 4 To deactivate the Lockout feature, touch and hold **Lower Clear/Off** for three seconds. The unlock melody sounds and the door and the controls unlock.

Start Time (Delayed Timed Cook)

The automatic timer of the Delayed Timed Cook function turns the oven on and off at the time you select. This feature can be used with the **Bake**, **Conv. Bake** and **Conv. Roast** modes.

Setting a Delayed Timed Cook

For example, to bake at 300 °F and delay the start of baking until 4:30, first set the clock for the correct time of day.

- 1 Touch **Bake**. 350 °F appears in the display.
- 2 Set the temperature: touch **3**, **0** and **0**.
- 3 Touch **Cook Time** and touch the number keys to set the baking time.
- 4 Touch **Start Time**.
- 5 Set the start time: touch **4**, **3** and **0** for 4:30.
- 6 Touch **Start**. A short beep sounds and **Timed Delay** and the start time appear in the display. The oven begins baking at the set start time.

NOTE

- To cancel the Delayed Timed Cook function, touch **Clear/Off** at any time.
- To change the cooking time, repeat step 3 and touch **Start**.
- If the oven clock is set as a 12-hour clock, you can delay the cook time for 12 hours. If the oven clock is set as a 24-hour clock, you can delay the cook time for 24 hours.

The oven will continue to cook for the set amount of time and then turn off automatically. When the cooking time has elapsed:

- **End** and the time of day show in the display.
- The cook end indicator tone sounds every 60 seconds until **Clear/Off** is touched.
- When **Warm** is set, the warming function is activated after the cooking time ends.

CAUTION

- Use the automatic timer when cooking cured or frozen meats and most fruits and vegetables. Foods that can easily spoil, such as milk, eggs, fish, meat or poultry, should be chilled in the refrigerator. Even when chilled, they should not stand in the oven for more than 1 hour before cooking begins, and should be removed promptly when cooking is completed.
- Eating spoiled food can result in sickness from food poisoning.

Cook Time (Timed Cook)

Set the oven to cook for a specific length of time using the Timed Cook feature. This feature can only be used with the **Bake**, **Conv. Bake** and **Conv. Roast** modes.

Setting a Timed Cook

For example, to bake at 300 °F for 30 minutes, first set the clock to the correct time of day.

- 1 Touch **Bake**. 350 °F appears in the display.
- 2 Set the temperature. Touch **3**, **0** and **0**.
- 3 Touch **Cook Time**. **Timed** flashes in the display. **Bake**, 0:00 and 300 °F appear in the display.
- 4 Set the baking time: touch **3** and **0** (for 30 minutes). The baking time can be set for any amount of time between 1 minute and 11 hours and 59 minutes.
- 5 Touch **Start**.

NOTE

To activate the Warm function at the end of the timed cook cycle, repeat steps 1-4 and then touch **Warm**. **Warm** appears in the display. (Refer to the Warm section on page 37)

The oven will continue to cook for the set amount of time and then turn off automatically. When the cooking time has elapsed:

- **End** and the time of day show in the display.
- The cook end indicator tone sounds every 60 seconds until **Clear/Off** is touched.
- When **Warm** is set, the warming function is activated after the cooking time ends.

Changing the Cook Time during Cooking

For example, to change the cook time from 30 minutes to 1 hour and 30 minutes, do the following.

- 1 Touch **Cook Time**.
- 2 Change the baking time: touch **1**, **3**, **0**.
- 3 Touch **Start** to accept the change.

Removing and Replacing the Oven Racks

⚠ CAUTION

- Replace the oven racks before turning the oven on to prevent burns.
- Do not cover the racks with aluminum foil, or any other material, or place anything on the bottom of the oven. Doing so will result in poor baking performance and may damage the oven bottom.
- Only arrange oven racks when the oven is cool.

Removing Racks

- 1 While wearing oven mitts, grasp the oven rack*.
- 2 Pull the rack straight out until it stops.
- 3 Lift up the front of the rack.
- 4 Pull out the rack.

* When possible, adjust oven racks before using the oven. Always wear oven mitts if adjusting racks while the oven is on.

Replacing Racks

- 1 While wearing oven mitts, place the end of the rack on the support*
- 2 Tilt the front end of the rack up.
- 3 Push the rack in.
- 4 Check that the rack is properly in place.

*When possible, adjust oven racks before using the oven. Always wear oven mitts if adjusting racks while the oven is on.

Recommended Baking and Roasting Guide

- Center pans on racks for best baking results. If baking with more than one pan, place the pans so that each one has at least 1" to 1½" of air space around it. Do not allow pans to touch the walls of the oven.
- If cooking on a single rack, place the standard rack in position 1 in the upper oven and position 2 in the lower oven. Center the cookware as shown in the single rack image.

- If cooking on multiple racks in the lower oven, place a standard rack in position 1 and an offset rack in position 4. Place the cookware as shown in the multiple rack image, with cookware on the top rack placed toward the front and cookware on the bottom rack placed toward the back.

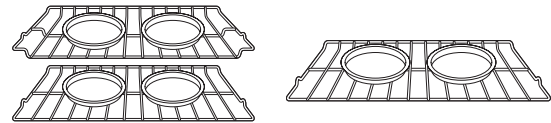

Multiple rack

Single rack

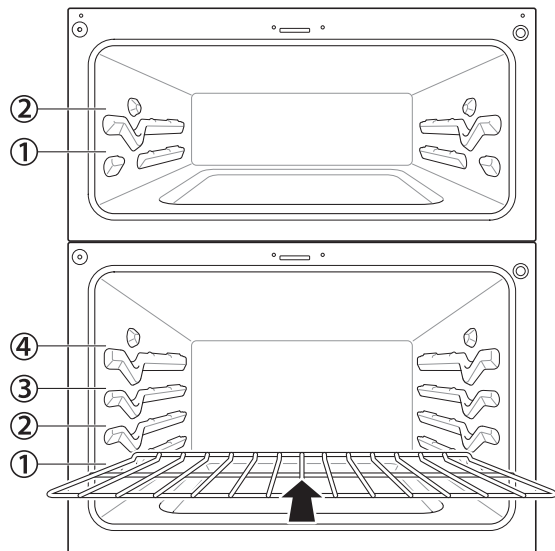

Bake

Bake is used to prepare foods such as pastries, breads and casseroles. The oven can be programmed to bake at any temperature from 170 °F (80 °C) to 550 °F (285 °C). The default temperature is 350 °F (175 °C).

Setting the Bake Function (example, 375 °F)

- 1 Touch **Bake**.
- 2 Set the oven temperature: touch **3, 7** and **5**.
- 3 Touch **Start**. The oven starts to preheat.

As the oven preheats, the temperature is displayed and rises in 5-degree increments. Once the oven reaches the set temperature, a tone sounds and the oven light blinks on and off.

- 4 When cooking is complete, touch **Clear/Off**.
- 5 Remove food from the oven.

NOTE

- It is normal for the convection fan to operate periodically throughout a normal bake cycle in the lower oven. This is to ensure even baking results.
- The convection fan may continue to run for a short time after the oven is turned off.

Baking Chart

This chart is only for reference and can be used for both the upper and lower ovens. Adjust the cook time according to your recipe.

| Food | Oven Temperature | Rack position | |
|------------------------------|------------------|---------------|------------|
| | | Upper Oven | Lower Oven |
| Cakes | | | |
| - Layer cake | 350 °F (175 °C) | 1 | 2 |
| - Bundt cake | 350 °F (175 °C) | 1 | 2 |
| - Cupcakes | 350 °F (175 °C) | 1 | 2 |
| - Pound cake | 350 °F (175 °C) | 1 | 2 |
| - Carrot cake (from scratch) | 350 °F (175 °C) | 1 | 2 |
| Cookies | | | |
| - Sugar cookies | 350 °F (175 °C) | 1 | 2 |
| - Chocolate chip | 350 °F (175 °C) | 1 | 2 |
| - Brownies | 350 °F (175 °C) | 1 | 2 |
| Pizza | | | |
| - Rising | 400 °F (204 °C) | 2 | 2 |
| - Frozen | 400 °F (204 °C) | 2 | 2 |
| - Fresh | 425 °F (218 °C) | 2 | 2 |
| Breads | | | |
| - Biscuits (canned) | 350 °F (175 °C) | 1 | 2 |
| - Biscuits (from scratch) | 425 °F (218 °C) | 1 | 2 |
| - Muffins | 425 °F (218 °C) | 1 | 2 |
| Fruits and Vegetables | | | |
| - Apples (baked) | 375 °F (190 °C) | 1 | 2 |
| - Potatoes (baked) | 425 °F (218 °C) | 1 | 2 |

NOTE

- Because the oven temperature cycles, an oven thermometer placed in the oven cavity may not show the same temperature that is set on the oven.
- It is normal for the convection fan to run while preheating during a regular bake cycle.
- The convection fan motor may run periodically during a regular bake cycle.
- **The bake burner turns off if the door is left open during baking.** If the door is left open for longer than 30 seconds during baking, the bake burner turns off. The bake burner turns back on automatically once the door is closed.

Convection Mode

The convection system uses a fan to circulate heat evenly within the oven. This improves heat distribution and allows for even cooking and excellent results, especially when using multiple racks. Convection cooking can also shorten cooking times.

Convection Bake

Setting the Conv. Bake Function (example: to Conv. Bake 375 °F)

- 1 Touch **Conv. Bake**. The display flashes 350 °F.
- 2 Set the oven temperature: touch **3**, **7** and **5**.
 - Convection Bake cooks faster and more evenly when cooking foods like cookies, biscuits, rolls, or other baked goods on a single rack. Cookies, muffins, and biscuits will have very good results when using multiple racks.
 - Multiple rack cooking may slightly increase times for some foods, but the overall time is reduced.
 - Convection Bake gives excellent results for quick breads and yeast breads of all kinds, and breads and pastries brown more evenly.
 - Do not use Convection Bake for delicate items like custards, souffles, or cheesecakes, which may be disturbed by the convection fan.

NOTE

- The convection cooking modes automatically reduce the oven temperature by 25 °F (14 °C). The display shows the changed temperature.
- This feature is called auto conversion.
- The range comes with this feature enabled.
- To disable the auto conversion feature, see Setting Convection Auto Conversion, page 28.
- The oven fan runs while convection baking. If the door is left open for longer than 30 seconds during baking, the fan stops.

- 3 Touch **Start**. The display shows **Conv. Bake** and the converted temperature starting at 100 °F. As the oven preheats, the displayed temperature will increase in 5-degree increments.
- 4 Once the oven reaches the desired temperature, a tone sounds and the oven light blinks on and off. The display shows the auto converted oven temperature 350 °F, **Conv. Bake** and .

Convection Baking Chart

If auto conversion is disabled, reduce standard recipe temperature by 25 °F (14 °C) for Convection Bake. Temperatures have been adjusted in this chart. Multi-rack cooking may slightly increase cook times for some foods, but the overall time is reduced. This chart is only for reference. Adjust cooking time according to your preference.

| Food | Oven Temperature (converted) | Rack position |
|---|------------------------------|---------------|
| Cakes | | |
| - Layer cakes | 325 °F (161 °C) | 2 |
| - Bundt cakes | 325 °F (161 °C) | 2 |
| Cakes, Specialty | | |
| - Popovers | 400 °F (204 °C) | 2 |
| - Cupcakes | 325 °F (161 °C) | 2 |
| - Pound cakes | 325 °F (161 °C) | 2 |
| Cookies | | |
| - Sugar cookies | 325 °F (161 °C) | 2 |
| - Chocolate chips | 325 °F (161 °C) | 2 |
| - Brownies | 325 °F (161 °C) | 2 |
| Pizza | | |
| - Frozen | 375 °F (190 °C) | 2 |
| - Fresh | 385 °F (196 °C) | 2 |
| Breads | | |
| - Biscuit, canned | 325 °F (161 °C) | 2 |
| - Biscuit, from scratch | 350 °F (175 °C) | 2 |
| - Muffins | 375 °F (190 °C) | 2 |
| - White bread, loaf | 400 °F (204 °C) | 2 |
| Pastry Crust | | |
| - From scratch | 400 °F (204 °C) | 2 |
| - Refrigerator | 400 °F (204 °C) | 2 |
| Desserts | | |
| - Fruit crisps and cobblers, from scratch | 350 °F (175 °C) | 2 |
| - Pies, from scratch, 2 crust fruit | 350 °F (175 °C) | 2 |

Cookware for Convection Cooking

Any cookware safe for use in a conventional oven will work in a convection oven. But for best results, keep the following in mind.

- Make sure pans don't touch the oven walls when centered on the racks. Use cookware that leaves room for air circulation in the oven for best results when convection cooking.
- Leave space between pans. Make sure pans don't touch each other or the oven walls.
- Do not use pans with high sides. Use flat pans with no sides for cookies or biscuits. Use a pan with low sides for oven-baked chicken.
- Metal pans heat the fastest. Heat-resistant paper and plastic containers that are recommended for use in regular ovens can be used in convection ovens. Glass and ceramic pans can also be used. However, metal pans heat the fastest and are recommended for convection cooking.
- Food cooked on pans with dark or matte finishes cooks faster than food on pans with shiny finishes.
- Use the pan size recommended in the recipe.

NOTE

- Some frozen foods have been developed to use commercial convection ovens. For best results in this oven, preheat the oven and use the temperature recommended on the packaging.
- If a food manufacturer gives specific convection cooking instructions, remember that convection autoconversion will reduce the set temperature by 25 °F (14 °C). If auto-conversion is enabled, add 25 °F (14 °C) when setting the temperature to get a resulting converted temperature which matches the recipe.

Convection Roast

The Convection Roast feature is designed to give optimum roasting performance. Convection Roast combines cooking with the convection fan to roast meats and poultry. The heated air circulates around the food from all sides, sealing in juices and flavors. Food cooked in this manner is crispy brown on the outside while staying moist on the inside.

Setting the Conv. Roast Function (example: to Conv. Roast 375 °F)

- 1 Touch **Conv. Roast**. The display shows 350 °F.
- 2 Set the oven temperature: touch **3**, **7** and **5**.

NOTE

The convection cooking modes automatically reduce the oven temperature by 25 °F (14 °C). The display shows the changed temperature. This feature is called auto conversion. The range comes with this feature enabled. To disable the auto conversion feature, see Setting Convection Auto Conversion, page 28.

- 3 Touch **Start**. The display shows **Conv. Roast** and the changing temperature starting at 100 °F. As the oven preheats, the displayed temperature will increase in 5-degree increments.
- 4 Once the oven reaches the desired temperature, a tone sounds and the oven light flashes on and off. The display shows the auto converted oven temperature 350 °F, **Conv. Roast** and .
- 5 Place food in oven.

Broil

Your oven is designed for closed-door broiling. Broil uses an intense heat radiation from the upper gas burner.

The Broil function works best when broiling thin, tender cuts of meat (1" or less), poultry or fish.

CAUTION

- Do not use a broiler pan without a grid. The oil can cause a grease fire.
- Do not cover the grid and broiler pan with aluminum foil. Doing so will cause a fire.
- Always use a broiler pan and grid for excess fat and grease drainage. This will help to reduce splatter, smoke, and flare-ups.
- Never use a broiler pan that is not thoroughly cleaned and at room temperature. If your broiler pan is damaged, warped, or has heavy permanent soiling, consider replacing it to reduce the amount of smoke you experience during broiling.

NOTE

- Use Lo broil to broil foods such as poultry and thick cuts of meat.
- Remove the pan from the oven to cool down for easy cleaning.
- For best results, use a pan designed for broiling, as shown below. The broiler pan will catch grease spills and the grid will help prevent grease splatters.

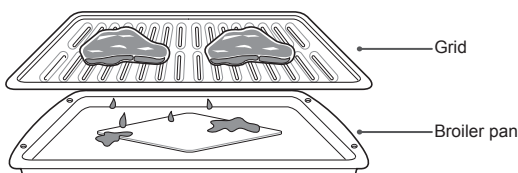

When broiling on rack position in the upper oven, use the standard rack provided for better cooking results.

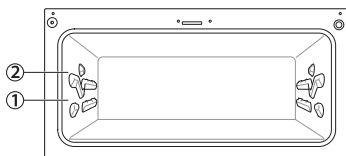

CAUTION

Take care when sliding the offset rack in and out. It lies lower in the cavity and passes closer to hot surfaces that can cause burns. Always wear oven mitts when handling racks.

Setting the Upper oven to Broil

- 1 Touch **Broil** once for **Hi** and twice for **Lo**.
- 2 Touch **Start**.
- 3 Allow the broiler to preheat for five minutes.
- 4 Place food in the upper oven.
- 5 Close the oven door. The oven door must be closed during broiling.

WARNING

When using your broiler, the temperature inside the oven is extremely hot. Take caution to avoid possible burns by:

- Keeping the door closed when broiling
- Always wearing oven mitts when inserting/removing food items

Improper use of the broiler may result in excessive smoke or a grease fire. Improper use conditions include, but are not limited to:

- Setting the broiler to a higher power level than recommended.
- Using dirty/greasy broiler pans.
- Broiling beyond recommended cooking times.

NOTE

- This range is designed for closed-door broiling. Close the door to set the Broil function. If the door is open, the Broil function cannot be set and **door** appears on the display. Close the door and reset the Broil function. Opening the door turns off the broil burner during broiling. If the door is opened during broiling, the broil burner turns off after five seconds. The broiler turns back on automatically once the door is closed.

- 6 When broiling is finished, touch **Upper Clear/Off**.

NOTE

During any Broil function, it is normal for the broiler to cycle on and off. The igniter for the broil burner on the ceiling of the oven glows orange periodically during normal broil operation.

Recommended Broiling Guide

The size, weight, thickness, starting temperature, and your preference of doneness will affect broiling times. This guide is based on meats at refrigerator temperature. For best results when broiling, use a pan designed for broiling.

| Food | Quantity and/or Thickness | Upper oven | | | Comments |
|---------------------------------|---|---------------|----------------------|-----------------------|--|
| | | Rack Position | First Side (minutes) | Second Side (minutes) | |
| Ground Beef Well done | 1 lb. (4 patties) 1/2 to 3/4" thick | 2 | 5-7 | 3-5 | Space evenly. Up to 8 patties may be broiled at once. |
| Beef Steaks | | | | | Steaks less than 1" thick cook through before browning. Pan frying is recommended. Slash fat. |
| Rare | | 2 | 4-6 | 2-3 | |
| Medium | 1" thick | 2 | 5-7 | 3-4 | |
| Well Done | 1 to 1 1/2 lbs. | 2 | 6-8 | 4-5 | |
| Rare | 1 1/2" thick | 1 | 8 | 3-4 | |
| Medium | 2 to 2 1/2 lbs. | 1 | 9 | 4-5 | |
| Well Done | | 1 | 10 | 5-6 | |
| Chicken | 1 whole cut up 2 to 2 1/2 lbs., split lengthwise | 1 | 8-10 | 5-7 | Broil skin-side-down first. |
| | 2 breasts | 1 | 8-9 | 5-6 | |
| Fish Fillets | 1/4 to 1/2" thick | 1 | 5 | 2-4 | Handle and turn very carefully. Brush with lemon butter before and during cooking, if desired. |
| Ham Slices (precooked) | 1/2" thick | 1 | 6-7 | 2-3 | Increase time 5 to 10 minutes per side for 1 1/2" thick or home-cured ham. |
| Pork chops Well Done | 1 (1/2" thick) | 1 | 4-6 | 3-5 | Slash fat. |
| | 2 (1" thick) about 1lb. | 1 | 7-9 | 5-7 | |
| Lamb Chops | | | | | Slash fat. |
| Medium | 2 (1" thick) about | 1 | 7-8 | 2-3 | |
| Well Done | 10 to 12 oz. | 1 | 8-9 | 3-4 | |
| Medium | 2 (1/2" thick) about 1lb. | 1 | 6-7 | 2-3 | |
| Well done | | 1 | 7-8 | 3-4 | |
| Salmon Steaks | 2 (1" thick) | 1 | 7-9 | 3-5 | Grease pan. Brush steaks with melted butter. |
| | 4 (1" thick) about 1lb. | 1 | 8-10 | 3-5 | |

- This guide is only for reference. Adjust cook time according to your preference.

NOTE

The USDA advises that consuming raw or undercooked fish, meat, or poultry can increase your risk of food-borne illness.

The USDA has indicated the following as safe minimum internal temperatures for consumption:

- Ground beef, veal, pork, or lamb: 160 °F (71.1 °C)
- Poultry: 165 °F (73.9 °C)
- Beef, veal, pork, or lamb: 145 °F (62.8 °C)
- Fish / Seafood: 145 °F (62.8 °C)

Pizza

This function automatically sets the upper or lower oven temperature to cook either frozen pizza with regular or rising crust, or freshly made pizza. Simply choose the type of pizza (see chart) and set the desired cook time.

Setting the Oven for Pizza

- 1 Touch **Pizza** once. **P1** appears in the display. Touch **Pizza** repeatedly to toggle between **P1**, **P2**, and **P3**. Select the desired option. (See Pizza Chart below.)
- 2 Touch **Start**. The oven starts to preheat.

As the oven preheats, the temperature is displayed and rises in 5-degree increments. Once the oven reaches the set temperature, a tone sounds and the oven light blinks on and off.

- 3 Place pizza in the oven, close the door and set the timer following the suggestions in the chart.
- 4 When cooking is complete touch **Clear/Off**.
- 5 Remove the food from the oven.

NOTE

Preheating is necessary for better cooking results. Place the food in the oven after preheating.

Pizza Chart

| Display Mode | Item | Rack position | | Recommended time (minutes) | |
|--------------|-----------------------------|---------------|------------|----------------------------|------------|
| | | Upper Oven | Lower Oven | Upper Oven | Lower Oven |
| P1 | Frozen pizza, Regular crust | 2 | 2 | 14-18 | 10-14 |
| P2 | Frozen pizza, Rising crust | 2 | 2 | 17-21 | 14-18 |
| P3 | Fresh Pizza | 1 | 2 | 18-22 | 10-14 |

Warm

This function will maintain an oven temperature of 170 °F. The Warm function will keep cooked food warm for serving up to three hours after cooking has finished. The Warm function may be used without any other cooking operations or can be used after cooking has finished using a Timed Cook or a Delayed Timed Cook.

Setting the Warm Function

- 1 Touch **Warm** or **Warm/Proof**. On the lower oven, touch **Warm/Proof** to toggle between warm and proof.
- 2 Touch **Start**.
- 3 Touch **Clear/Off** at any time to cancel.

Setting the Warm Function after a Timed Cook

- 1 Select the cooking function.
- 2 Enter the oven temperature using the number keys.
- 3 Touch **Cook Time** and enter the cook time using the number keys.
- 4 Touch **Warm**.
- 5 Touch **Start**.
- 6 When cooking is finished, touch **Clear/Off** to cancel the Warm function.

NOTE

- The Warm function is intended to keep food warm. Do not use it to cool food down.
- It is normal for the fan to operate during the Warm function.

Proof

This feature maintains a warm oven for rising yeast leavened products before baking.

Setting the Proof Function

- 1 Use rack position 2 or 3 for proofing.
- 2 Touch **Warm/Proof** until **Proof** appears in the display.
- 3 Touch **Start**.
- 4 Touch **Clear/Off** when proofing is finished.

NOTE

- To avoid lowering the oven temperature and lengthening proofing time, do not open the oven door unnecessarily. Check bread products early to avoid over proofing.
- Do not use the proofing mode for warming food or keeping food hot. The proofing oven temperature is not hot enough to keep foods at safe temperatures. Use the Warm feature to keep food warm. Proofing does not operate when the oven is above 125 °F. **Hot** shows in the display.
- It is normal for the fan to operate during the Proof function.