

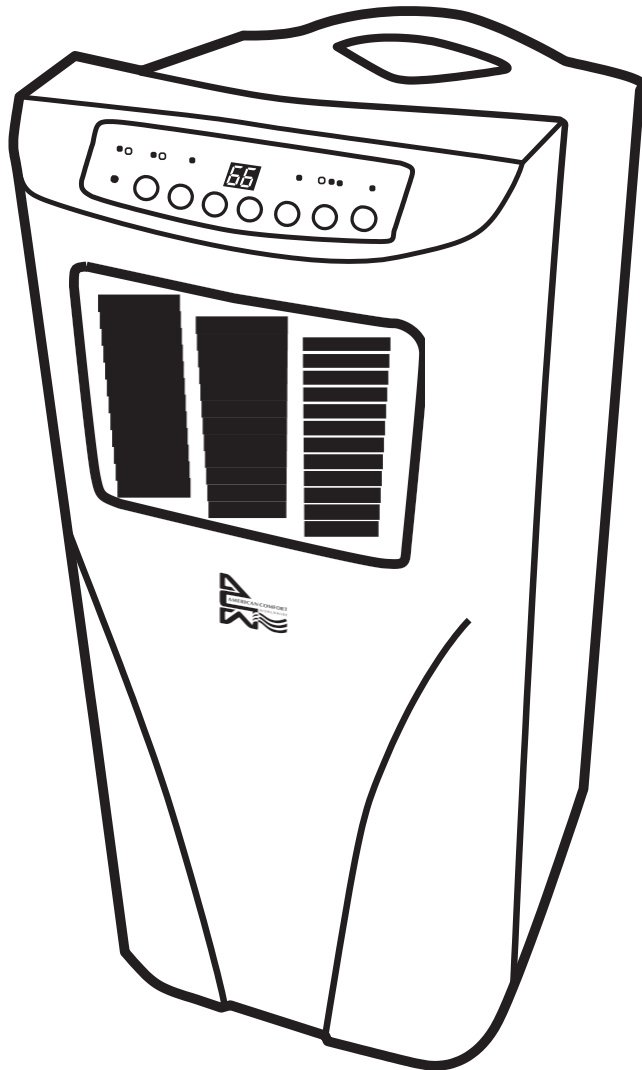

AMERICAN COMFORT WORLDWIDE

Owner's Manual

Portable Air Conditioner with Heat ACW200C / ACW200CH



It is important that you read these instructions before using your new purchase and we strongly recommend that you keep them in a safe place for future reference.

Innovative AutoDrain Technology

Table of Contents

Thank You!	1
Safety Instructions	1-2
Specifications	3
Parts	4
AutoDrain Technology Assembly	5
Positioning	6
Control Panel	7
Remote Control	8
Operation	9
Emptying the Water Container	10
Cleaning	11
Troubleshooting	12
Warranty	14

Thank You!

Thank you for purchasing an ACW Portable Air Conditioner with Heat.

ACW is a leading brand in indoor air treatment. We would like you to enjoy the many benefits this unit offers, so please read this manual carefully and take full advantage of the many advanced features that your American Comfort Worldwide Air Conditioner with heat offers you.

ACW has specialized in complete indoor environment control, manufacturing world-class air conditioners with innovative technology.

In designing these advanced products, we have listened carefully to our customers and have passed their views on to our research and development laboratories.

After reading this manual, please keep it in a safe place for future reference.

Read this entire instruction manual before use.

Please keep your receipt and the unit's original box for a warranty return.

Safety Instructions

IMPORTANT!

- The unit is designed for indoor operation.
- The unit is not designed to cool server rooms, sun rooms, or a room generating constant high levels of heat.
- Rating: This unit must be connected to a 115V/60Hz grounded outlet.
- The installation must be in accordance with regulations of the country where the unit is used.

If you are in any doubt about the electrical installation, have it checked and if necessary modified by a qualified electrician.

- Never connect the unit to an electrical outlet using an extension cord.
If an outlet is not available, one should be installed by a licensed electrician.
- This unit is safe. However, as with any electrical appliance, use it with care.
- Keep out of the reach of children.
- Do not clean the unit by spraying it or immersing it in water.
- Do not insert any object into the openings of the unit.
- Disconnect the unit from the outlet before cleaning the unit or any of its components.

WARNING!

- Never operate this appliance if it has a damaged cord or plug.
- Do not lead the cord over sharp edges.
- A damaged supply cord should be replaced by the manufacturer, its service agent or a qualified person in order to avoid a hazard.
- Any service other than regular cleaning or filter replacement should be performed by an authorized service representative. Failure to do so could result in a loss of warranty.
- See warranty page to read about warranty requirements, procedure, and instructions.

Safety Instructions

Do not use your unit:



If the power cable wires are frayed or cut



When small children may be left unattended

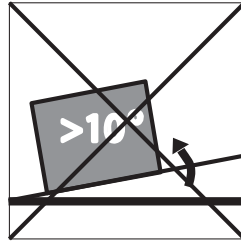

On a slope or uneven surface



Close to a heat source

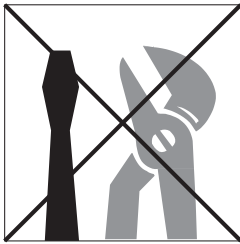

This products is not made for DIY repair



If there is a risk of liquid falling on the unit

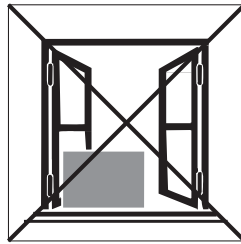

Inside unit exposed to the weather outdoors

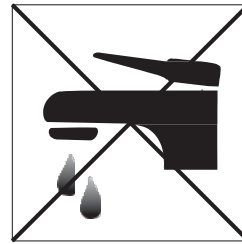

In a permanent very humid environment

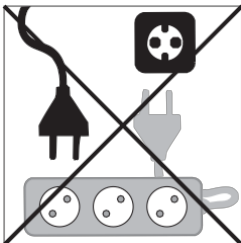

Do Not Connect the unit to extension cord.

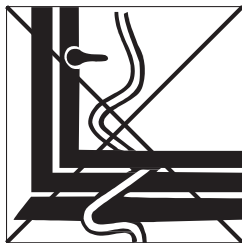

Where the power cable may be damaged



Where it may be damaged by chemicals

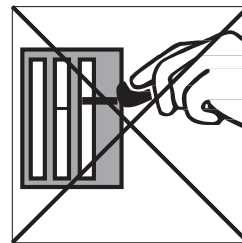

Where there is a risk of interference by foreign objects

IMPORTANT:

The first time that you use the unit, please ensure that it has been standing in an upright position for at least 2 hours before it is switched on.

The unit is not to be used in temperatures under 41°F or over 95°F.

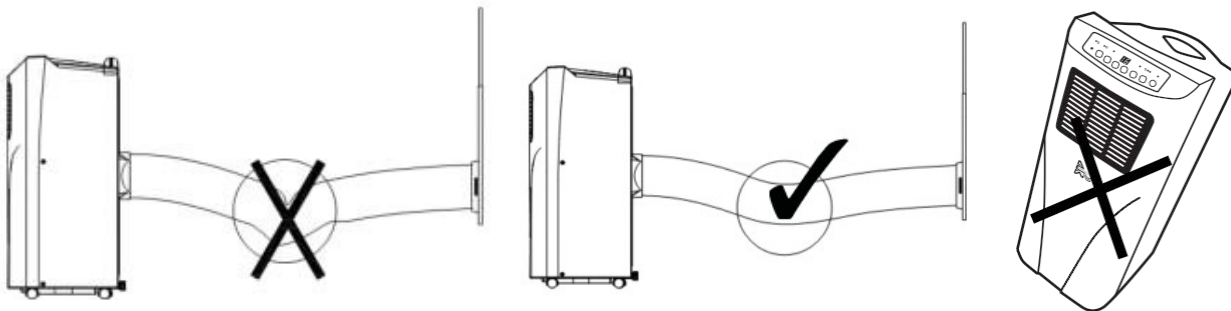

Reminder:

Unit Contains R410A. Waste electrical products must not be disposed of with household waste. This product should be taken to your local recycling center for safe treatment.

Specifications

Model	ACW200C	ACW200CH
Cooling Capacity	8,000 BTU/h	8,000 BTU/h
Heating Capacity	N/A	8,000 BTU/h
Cooling/Heating Power Consumption / Current	890W / 7.5A	890W / 7.5A
Moisture Removal	66 pints/day	66 pints/day
Power Supply	110-120V/60Hz	110-120V/60Hz
Refrigerant	R410A	R410A
Compressor	Rotary	Rotary
Fan Speed	2 Speeds	2 Speeds
Thermostat	60°F - 90°F	60°F - 90°F
Ambient Temperature Range for Operation	Cooling: 64.4°F - 104°F	Cooling: 64.4°F - 104°F Heating: 41°F - 80.6°F
Timer	24 hour Timer	24 hour Timer
Dimensions	12.6"W x 14.2"D x 28.7"H	12.6"W x 14.2"D x 28.7"H
Weight	44 lbs.	44 lbs.

The cooling capacity of the unit may be affected by the height of your ceiling, quality of your insulation, or number of windows in your room. There is no current testing statute for portable air conditioning products in the United States, yet we have made every effort to design engineer a superior quality portable air conditioning unit that effectively and efficiently cools select areas of the home or office.

These portable air conditioning units are designed engineered to provide supplemental air conditioning.

To gain a better understanding of the performance capabilities of your new ACW portable unit, you can visit us online at: www.americancomfort.com/portableacdisclaimer

Parts

Front Side

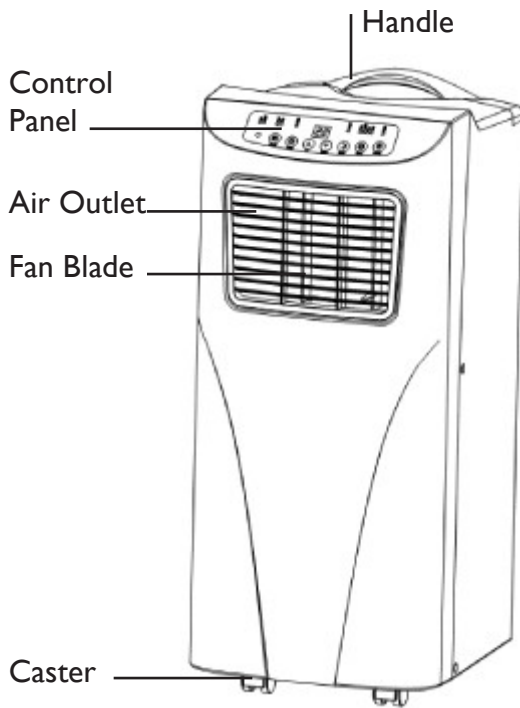

Back Side

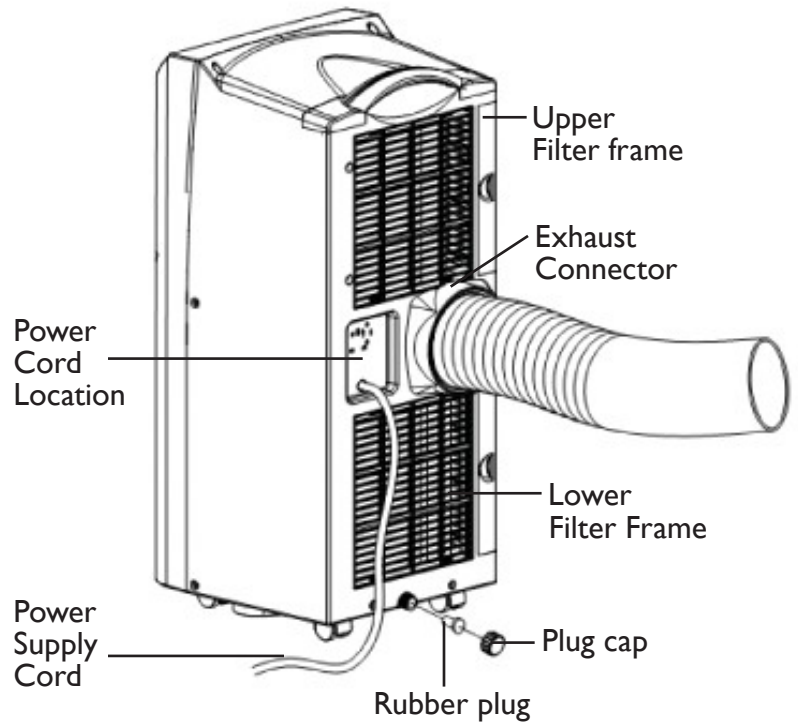

Check packing accessories and read your user's manual to learn how to use them.

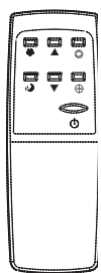

Remote Control

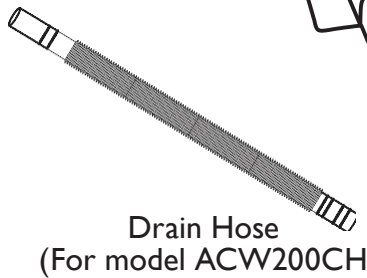

Drain Hose
(For model ACW200CH)

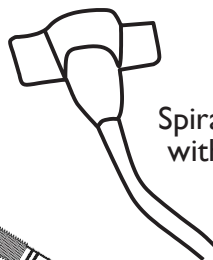

Spiral water pipe
with connector

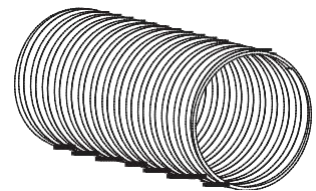

Exhaust Hose



Insulation
Strip

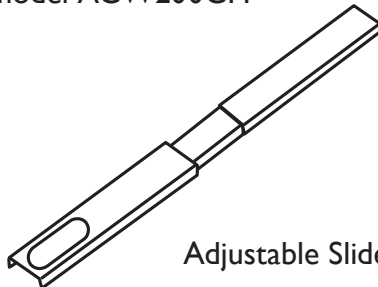

Adjustable Slide Bar

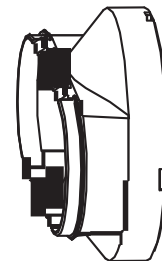

Slide Bar
Connector

AutoDrain Technology Assembly

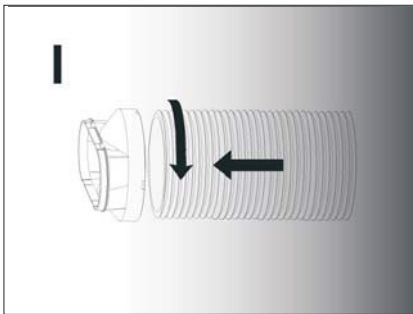

1
Attach Window Slide Bar Connector to Exhaust Hose by twisting as shown.



2
Put spiral water pipe into hot air flexible hose.



3
Connect the female half of the quick connector at the end of the spiral water pipe to the male part in the hot air outlet pipe.



4
Turn the connector 45° clockwise until it is locked in place.



5
Stretch end of the hose slightly. Assemble the hot air hose on the unit by screwing in clockwise.



6
Clip on the water atomizer at the end of the spiral pipe to the holder.



7
Unfold flexible hose with attached hose adapter connector, and snap into Window Slide Bar.



8
Only Required For Disassembly.
In order to unlock the quick connector, push the tab and turn the connector counter-clockwise.

Positioning

This unit can easily be moved from one room to another. In doing, so keep this in mind:

- The unit must stand upright on an even surface.
- Do not position near bath, sink, or other permanent, wet or damp area.
- Keep unit at least 18" from wall, curtains, draperies, or heat sources to insure adequate air circulation.

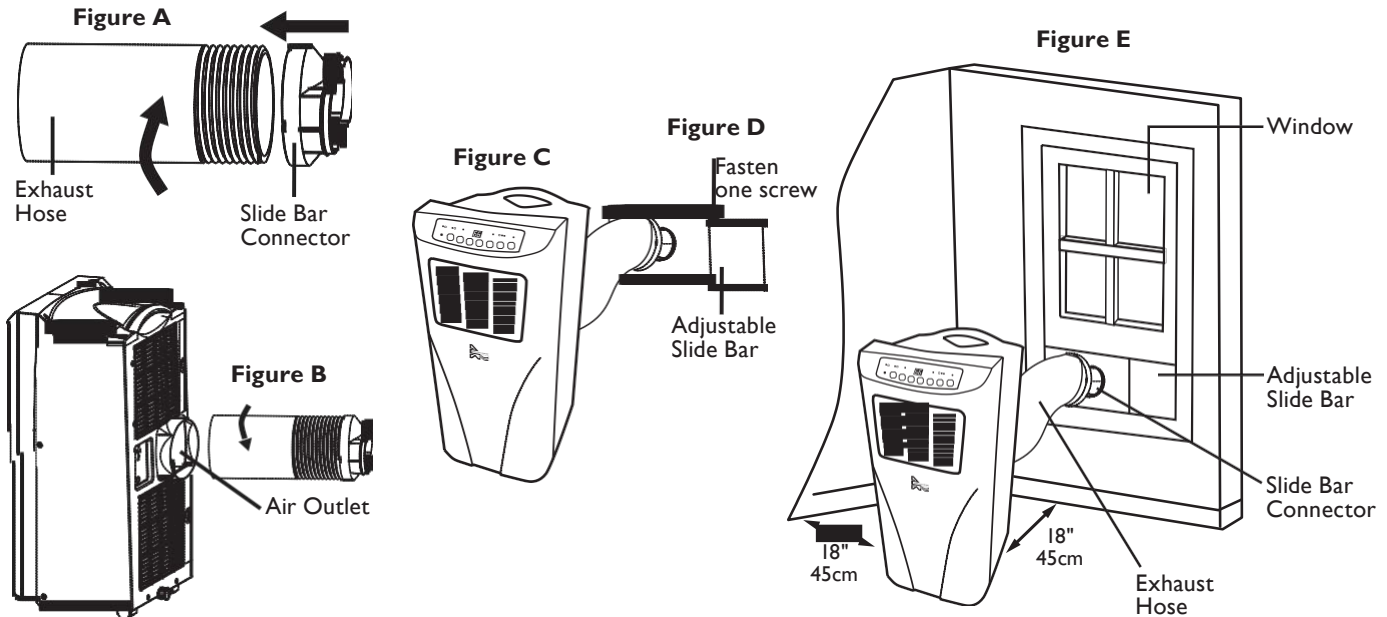

Installing Exhaust Hose to Window Slide Bar for AC and Heating

Note: The window kit is only designed to be installed with sliding windows or doors. The window kit is not designed or to be used with casement style windows. Measure your window kit according to the dimensions of your sliding window. If the unit is larger than your required dimensions, it can be cut using a saw or power tool. If the unit is too short for your opening, you can order an additional window kit from our online store to extend it.

After assembling the Innovative AutoDrain Technology as per instructions on page 5, make sure hose is firmly attached to oval connector that fits into window slide bar.

Snap hose connector into window slide bar opening. See Illustration I.

Extend window slide bar to fit your window opening, either vertical or horizontal, depending on how the window opens. See Figure D.

Important

The flexible exhaust hose can be extended from 12" to 60" for mounting. We recommend that you keep the hose as short as possible to minimize possible loss back in the room.

This length has been designed especially according to the specifications of the unit.

Do not use an extension or exchange for a different hose as that may lead to malfunctioning.

The exhaust air must flow freely. Any blockage can lead to overheating of the unit. Handle with care to prevent any kink or bend in the exhaust hose.

Control Panel

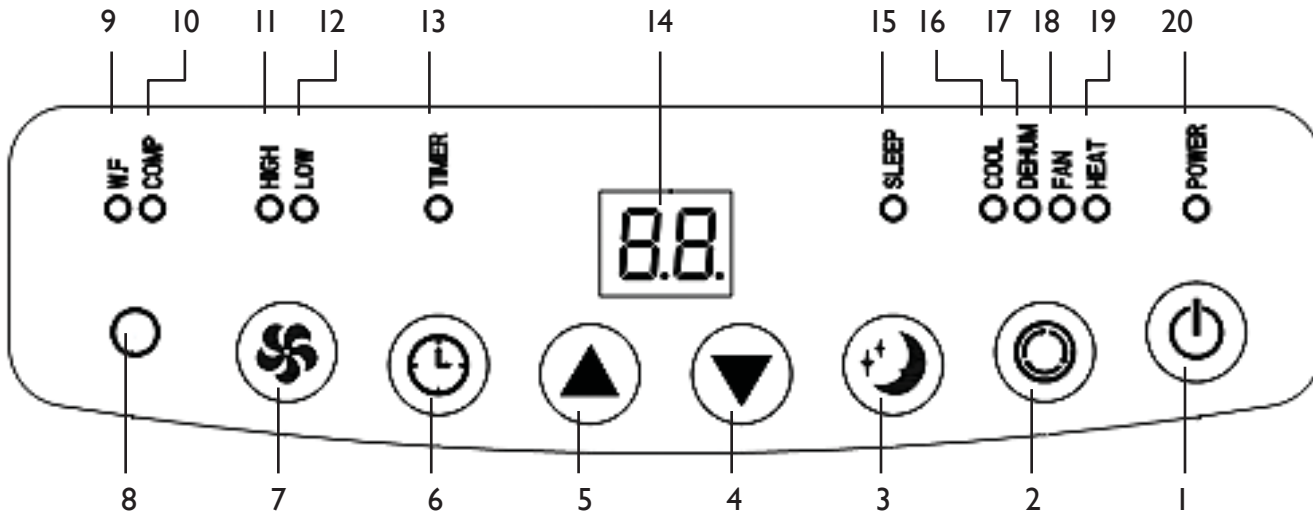

- | | |
|--------------------------------|--------------------------------------------|
| 1. On/Off (Power) Button | 11. High Ventilation Indicator |
| 2. Mode (Function) Button | 12. Low Ventilation Indicator |
| 3. Sleep Function Button | 13. Timer Operation Indicator |
| 4. "Temperature Down" Button | 14. Display Window |
| 5. "Temperature Up" Button | 15. Sleep Operation Indicator |
| 6. Timer Button | 16. Cooling Operation Indicator |
| 7. Speed (Ventilation) Button | 17. Dehumidify Operation Indicator |
| 8. Receiver For Remote Control | 18. Fan Operation Indicator |
| 9. "Water Full" Indicator | 19. Heating Operating Indicator (optional) |
| 10. Indicator For Compressor | 20. Power Indicator |

1. **POWER:** Press this key to turn on/off machine.
After machine turns on, default operation is cooling mode with low fan speed.
2. **MODE:** After machine turns on, for cooling only model, press this key to select cooling, dehumidifying and fan mode; for cooling & heating model, press this key to select cooling, dehumidifying, fan and heating mode
3. **FAN:** After machine turns on, press this key to select fan speed (high and low).
4. **DOWN:** Under cooling or heating mode, press this key to downward setting temperature from 60°F~90°F; under timer mode, press this key to downward on/off time.
5. **UP:** Under cooling or heating mode, press this key to upward temperature from 60°F~90°F; under timer mode, press this key to upward on/off timer.
6. **SLEEP:** Under cooling or heating mode, press this key to turn on/off sleeping function.
7. **TIMER:** Under power-on or standby mode, press this key to setup on/off time from 0~24 hours.

Remote Control

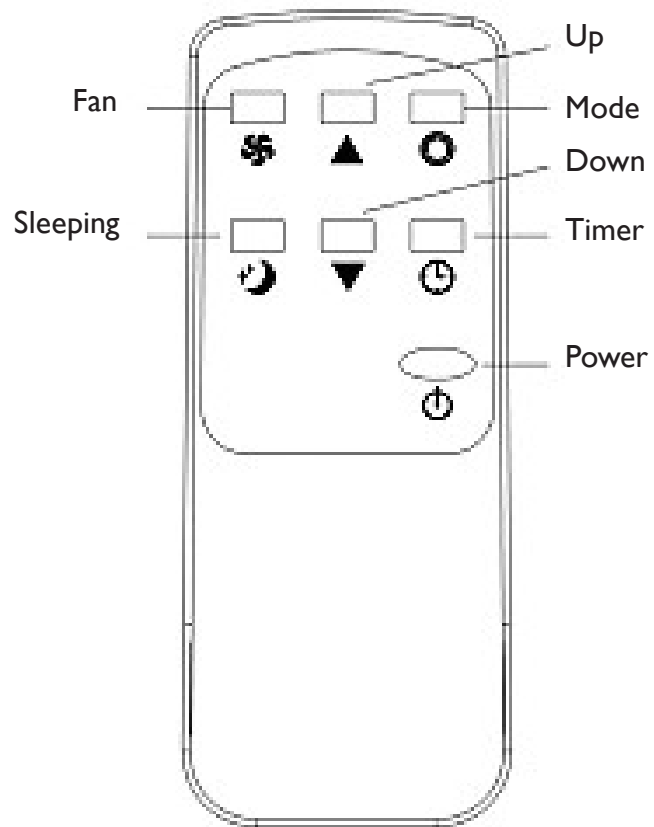

Operation

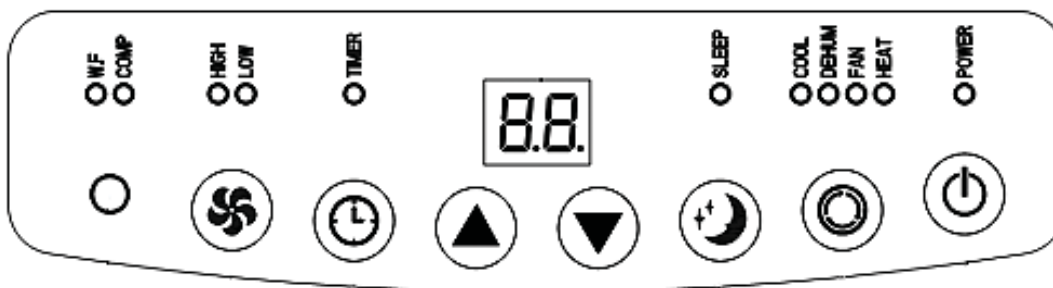

Cooling Mode

- After machine turns on, default value is cooling mode with 72°F and low fan speed.
- Press “MODE” to select cooling mode, cooling mode indicator turns on.
- Press “UP” or “DOWN” to adjust temperature (from 60°F to 90°F).
- Press “FAN” to select fan speed (low, high)

Heating Mode

- Press “MODE” to select heating mode, heating mode indicator turns on (only for cooling and heating model).
- Press “UP” or “DOWN” to adjust temperature (from 60°F to 90°F).
- Press “FAN” to select fan speed (low, high)

Fan Mode

- Press “MODE” to select fan mode, fan mode indicator turns on .
- Press “FAN” to select fan speed (low, high)
- Temperature and sleeping function cannot be setup.

Timer Mode

- Under standby mode, press “TIMER” to setup the power-on time, press “UP” and “DOWN” to adjust the timer (from 1 to 24 hours). Timer indicator turns on.
- Under power-on mode, press “TIMER” to setup power-off timer. Press “UP” and “DOWN” to adjust the timer (from 1 to 24 hours). Timer indicator turns on.

Sleeping Mode

- Press key “SLEEP” enters into sleeping mode, default value of fan speed is low.
- When sleeping mode turns on, under cooling mode, the one hour later, setting temperature will go up 1°, the second one hour later, setting temperature will go up another 1°, and then keep the same; under heating mode, the first one hour later, setting temperature will go down 1°, the second one hour later, the setting temperature will go down another 1° and then keep the same .
- Sleeping mode is invalid under dehumidifying and fan mode.
Under water full, machine standby and mode conversion, sleeping mode will be cancelled.

Compressor Protection

- Three minutes later after power on / restart, compressor starts to run.

Emptying The Water Container

This air conditioning does not require emptying of the water container, except prior to season end storage.

This portable AC/H features the Innovative AutoDrain Technology

Very little excess water should accumulate. During the process of cooling, some of the water accumulated is actually used to cool the unit internally. This makes the unit run more efficiently. Both this evaporative technology and Innovative AutoDrain Technology are features not found in most portable air conditioners.

Switch off the unit and remove the plug from the outlet.

- Position a flat container or dish on the floor under the drain hole. Do not allow the water to drip continuously into the container as it might easily overflow.
- Remove the drain knob.
- Remove the rubber plug, the water will flow in the container. When this is nearly full, replace the plug to stop the water flow and empty it. Repeat this process until all water has been removed.
- Replace the rubber plug into the drain hole firmly, the WATER FULL LED should not flash any longer.
- Replace the drain knob.

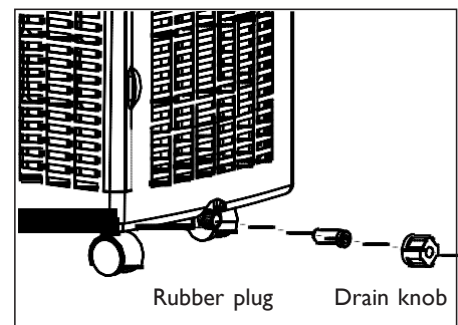

Cleaning

Always unplug the unit from the power supply (wall outlet) before beginning the cleaning.

Housing

Use a soft, damp cloth to wipe the body clean. Never use strong chemicals, oil-based products, detergents, chemically treated cloths or other cleaning solutions. These could possibly damage the housing.

Filter

- Clean the filters every two weeks, if filters are blocked by dust, machine efficiency will be reduced.
- Use a vacuum cleaner or tap the filter lightly to remove loose dust and dirt from the filters and then rinse them thoroughly under running water (not warmer than 104°F).
- Dry thoroughly with a soft cloth before inserting them back into the unit.

Notice! Never operate the unit without the filters.

Troubleshooting

Never try to repair or dismantle the air condition yourself.

Incompetent repairs result in loss of warranty and can endanger the user and the property.

Problem	Cause	Solution
The unit does not function.*	No power supply. Make sure the green light on the plug is lit.	Connect to a functioning outlet and switch on. See below for Plug and Reset button application.
	Is the power light flashing? Is the water full LED lit?	Empty the water container (See pg. 9).
The unit does not seem to perform.	The unit is in direct sunlight.	Close curtains/shades
	Windows or doors open, many people or a heat source in the room.	Close doors and windows. Unit is not made to cool server rooms, sun rooms, or any rooms generating a constant
	The filter is dirty.	Clean the filter (See pg. 10).
	Air inlet or air outlet blocked.	Power off the unit and unplug from outlet. Remove blockage.
	Room temperature lower than the selected value.	Change temperature selection. Set at the lowest possible setting: 60°F.
The unit is noisy.	Unit stands uneven.	Place on an even, solid surface (less vibrations).
The compressor does not work.	The overheat protection may be activated.	Wait 30 minutes until the temperature has decreased, then turn on the unit again.
The remote control does not function.	Distance too great.	Make sure the remote control is correctly aimed at the control panel.
	Remote control signal not detected by the control panel.	
	The batteries are drained.	Check batteries on remote.

Note: When abnormal situations occur, turn off machine and pull out plug, then contact with professional electrician for help

* LCDI Plug

If you plug in the unit, and there is no green light on the plug, press the reset button on the LCDI plug. The green light should be lit, indicating that the unit is getting power from the electrical outlet.

Make sure unit is plugged directly into a dedicated electrical source/outlet. Do not use any extension cords. See electrical specifications listed on page 3 and make sure the electrical source can accommodate the unit's energy consumption.

If the plug continues to trip (which is a USA national safety standard feature) and the green light goes off, the cord may be damaged preventing you from resetting the unit. For your safety, contact a licensed electrician.

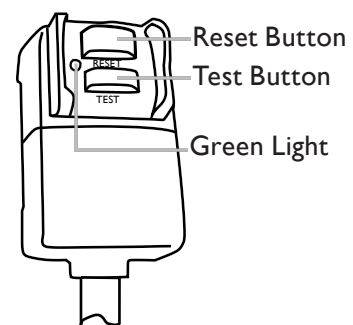

AMERICAN COMFORT

WORLDWIDE

One Year Limited Warranty

American Comfort Worldwide LLC ("ACW") warrants this ACW portable air conditioner to the original retail purchaser ("Purchaser") purchasing only in the 48 Contiguous States, for one year from the date of purchase, against defects in material and workmanship under normal use and service. Should your ACW Portable air conditioner prove defective within one year from the date of purchase, please follow our return procedure to return the defective unit. Within the first 30 days, ACW is responsible for the freight cost to and from our authorized service center for all units with an ACW authorized RMA. After 30 days and up to life of warranty (12 months), customer is responsible for freight costs to and from our authorized service center.

ACW's sole obligation under this warranty is to replace, or at ACW's discretion, to repair, free of charge, all defective parts, for a period of one (1) year from date of original purchase. All replacement parts and units will be new, remanufactured, or refurbished. ANY IMPLIED WARRANTY OF MERCHANTABILITY IS SIMILARLY LIMITED TO ONE (1) YEAR FROM DATE OF ORIGINAL PURCHASE AND NO ACTION BASED UPON ANY IMPLIED WARRANTY OF MERCHANTABILITY OR OTHERWISE MAY BE COMMENCED AFTER EXPIRATION OF ONE (1) YEAR FROM DATE OF ORIGINAL RETAIL PURCHASE. Some states do not allow limitations on how long an implied warranty lasts, so the above limitation may not apply to you. Proof of Purchase (i.e. copy of receipt) must be sent with the unit.

The provisions of this warranty shall not apply to any product which in ACW's judgment has been (1) subject to misuse or neglect. (2) damaged in an accident. (3) used for a purpose for which it was not designed, or (4) repaired or altered in any way that adversely affected its performance or reliability. Do not attempt to "open unit", except for filter replacement. Opening unit will void manufacturer's warranty.

THIS WARRANTY DOES NOT COVER:

- Damage, accidental or otherwise, to the unit while in the possession of the consumer not caused by a defect in material or workmanship.
- Damage caused by consumer misuse, tampering, or failure to follow the care and special handling provisions in the instructions.
- Damage to the finish of the case, or other appearance parts caused by the wear.
- Damage caused by repairs or alterations of the unit by anyone other than those authorized by American Comfort Worldwide.
- Freight and Insurance cost for the warranty service beyond 30 days from date of purchase up to life of warranty (12 months).

This warranty covers only new products purchased from our authorized dealers or retailers. It does not cover used, salvaged, or refurbished products.

To obtain warranty service, the defective product or part must be shipped or delivered to: American Comfort Worldwide, the Manufacturer. If warranty applies under ACW's approved terms, all Shipping charges and insurance are covered by purchaser.

AMERICAN COMFORT WORLDWIDE NEITHER ASSUMES NOR AUTHORIZES ANY PERSON TO ASSUME FOR IT ANY OTHER (LIABILITY IN CONNECTION WITH ITS PRODUCTS, THERE ARE NO WARRANTIES WHICH EXTEND BEYOND THE DESCRIPTION ON THE FACE HEREOF. NO RESPONSIBILITY IS ASSUMED FOR INCIDENTAL OR CONSEQUENTIAL DAMAGES THAT MAY RESULT FROM THE USE OF AN ACW PRODUCT, NOR FOR THE DAMAGES DUE TO ACCIDENT, ABUSE, LACK OF RESPONSIBLE CARE, THE AFFIXING OF ANY UNAUTHORIZED ATTACHMENT, LOSS OF PARTS, OR USE AT A VOLTAGE OTHER THAN SPECIFIED. Some states do not allow the exclusion of limitation of incidental or consequential damages, so these limitations may not apply to you. ACW disclaims all liabilities for defects or damages caused by use of replacement parts obtained from or by service at any service center other than American Comfort Worldwide, the Manufacturer.

This warranty gives you specific legal rights, and you may also have other rights which vary from state to state.

QUESTIONS? Call 1-877-645-0299 · www.americancomfort.com

02/11

7092192203B

Dear Customer: Please keep this warranty for your records, along with a copy of the original receipt.
DO NOT return it.