

# PROXXON

## Professional Grinder IBS/E



## Manual



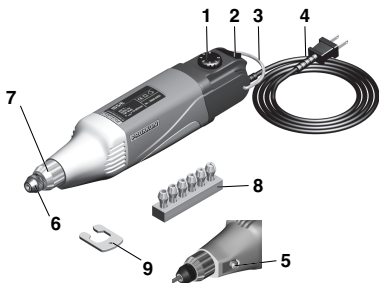

**Fig. 1**

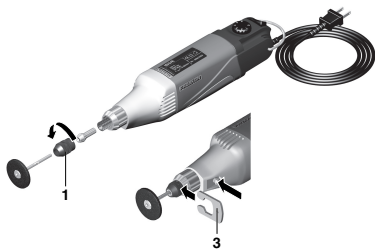

**Fig. 2**



**Fig. 3**



**Fig. 4**

# PROXXON – Professional Grinder IBS/E

Dear Customer,

Before putting the machine into operation, read the enclosed safety rules and operating instructions.

## General Safety Rules

Warning! Read and understand all instructions. Failure to follow all instructions listed below, may result in electric shock, fire and/or serious personal injury.

### Save these instructions.

#### Work Area

**Keep your work area clean and well lit.** Cluttered benches and dark areas invite accidents.

**Do not operate power tools in explosive atmospheres, such as in the presence of flammable liquids, gases, or dust.** Power tools create sparks which may ignite the dust or fumes.

**Keep bystanders, children, and visitors away while operating a power tool.** Distractions can cause you to lose control.

#### Electrical Safety

**Double Insulated tools are equipped with a polarized plug (one blade is wider than the other.)** This plug will fit in a polarized outlet only one way. If the plug does not fit fully in the outlet, reverse the plug. If it still does not fit, contact a qualified electrician to install a polarized outlet. Do not change the plug in any way. **Double Insulation eliminates the need for the three wire grounded power cord and grounded power supply system.**

**Avoid body contact with grounded surfaces such as pipes, radiators, ranges and refrigerators.** There is an increased risk of electric shock if your body is grounded.

**Do not expose power tools to rain or wet conditions.** Water entering a power tool will increase the risk of electric shock.

**Do not abuse the cord. Never use the cord to carry the tools or pull the plug from an outlet. Keep cord away from heat, oil, sharp edges or moving parts. Replace damaged cords immediately.** Damaged cords increase the risk of electric shock.

**When operating a power tool outside, use an outdoor extension cord marked "W-A" or "W."** These cords are rated for outdoor use and reduce the risk of electric shock.

#### Personal Safety

**Stay alert, watch what you are doing and use common sense when operating a power tool. Do not use tool while tired or under the influence of drugs, alcohol, or medication.** A moment of inattention while operating power tools may result in serious personal injury.

**Press properly. Do not wear loose clothing or jewelry. Contain long hair. Keep your hair, clothing, and gloves away from moving parts.** Loose clothes, jewelry, or long hair can be caught in moving parts.

**Avoid accidental starting. Be sure switch is off before plugging in.** Carrying tools with your finger on the switch or plugging in tools that have the switch on invites accidents.

**Remove adjusting keys or wrenches before turning the tool on.** A wrench or a key that is left attached to a rotating part of the tool may result in personal injury.

**Do not overreach. Keep proper footing and balance at all times.** Proper footing and balance enables better control of the tool in unexpected situations.

**Use safety equipment. Always wear eye protection.** Dust mask, non-skid safety shoes, hard hat, or hearing protection must be used for appropriate conditions.

#### Tool Use and Care

**Use clamps or other practical way to secure and support the workpiece to a stable platform.** Holding the work by hand or against your body is unstable and may lead to loss of control.

**Do not force tool. Use the correct tool for your application.** The correct tool will do the job better and safer at the rate for which it is designed.

**Do not use tool if switch does not turn it on or off.** Any tool that cannot be controlled with the switch is dangerous and must be repaired.

**Disconnect the plug from the power source before making any adjustments, changing accessories, or storing the tool.** Such preventive safety measures reduce the risk of starting the tool accidentally.

**Store idle tools out of reach of children and other untrained persons.** Tools are dangerous in the hands of untrained users.

**Maintain tools with care. Keep cutting tools sharp and clean.** Properly maintained tools, with sharp cutting edges are less likely to bind and are easier to control.

**Check for misalignment or binding of moving parts, breakage of parts, and any other condition that may affect the tools operation. If damaged, have the tool serviced before using.** Many accidents are caused by poorly maintained tools.

**Use only accessories that are recommended by the manufacturer for your model.** Accessories that may be suitable for one tool, may become hazardous when used on another tool.

## SERVICE

**Tool service must be performed only by qualified repair personnel.** Service or maintenance performed by unqualified personnel could result in a risk of injury.

**When servicing a tool, use only identical replacement parts. Follow instructions in the Maintenance section of this manual.** Use of unauthorized parts or failure to follow Maintenance Instructions may create a risk of electric shock or injury. Certain cleaning agents such as gasoline, carbon tetrachloride, ammonia etc. may damage plastic parts.

## Specific Safety Rules for Rotary Tools

---

**Hold tool by insulated gripping surfaces when performing an operation where the cutting tool may contact hidden wiring or its own cord.** Contact with a „live“ wire will make exposed metal parts of the tool „live“ and shock the operator. If cutting into existing walls or other blind areas where electrical wiring may exist is unavoidable, disconnect all fuses or circuit breakers feeding this worksite.

**Accessories must be rated for at least the speed recommended on the tool warning label.** Wheels and other accessories running over rated speed can fly apart and cause injury.

**Always disconnect the power cord from the power source before making any adjustments or attaching any accessories.** You may unexpectedly cause tool to start leading to serious personal injury.

**Be aware of the switch location, when placing the tool down or when picking the tool up.** You may accidentally activate the switch.

**Always wear safety goggles and dust mask. Use the tool only in ventilated area.** Using personal safety devices and working in safe environment reduces risk of injury.

**After changing the bits or making any adjustments, make sure the collet nut and any other adjustment devices are securely tightened.** Loose adjustment device can unexpectedly shift, causing loss of control, loose rotating components will be violently thrown.

**Do not reach in the area of the spinning bit.** The proximity of the spinning bit to your hand may not always be obvious.

**Allow brushes to run at operating speed for at least one minute before using. During this time no one is to stand in front or in line with the brush.** Loose bristles or wires will be discharged during the run in time.

**Wire and bristle brushes must never be operated at speeds greater than 15,000/min. Direct the discharge**

**the spinning wire brush away from you.** Small particles and tiny wire fragments may be discharged at high velocity during the „cleaning“ action with these brushes and may become embedded in your skin. Bristles or wires will be discharged from the brush at high speeds.

**Carefully handle both the tool and individual grinding wheels to avoid chipping or tracking. Install a new wheel, if tool is dropped while grinding. Do not use a wheel that may be damaged.** Fragments from a wheel that bursts during operation will fly away at great velocity possibly striking you or bystanders.

**Never use dull or damaged bits. Sharp bits must be handled with care.** Damaged bits can snap during use. Dull bits require more force to push the tool, possibly causing the bit to break.

**Use clamps to support workpiece whenever practical. Never hold a small workpiece in one hand and the tool in the other hand while in use. Allow for sufficient space between your hand and the spinning bit.** Round material such as dowel rods, pipes or tubing have a tendency to roll while being cut, and may cause the bit to „bite“ or jump toward you. Clamping a small workpiece allows you to use both hands to control the tool.

**Inspect your workpiece before cutting. When cutting irregularly shaped workpieces, plan your work so it will not slip and pinch the bit and be torn from your hand.** For example, if carving wood, make sure there are no nails or foreign objects in the workpiece. Nails or foreign objects can cause the bit to jump.

**Never start the tool when the bit is engaged in the material.** The bit cutting edge may grab the material causing loss of control of the cutter.

**Avoid bouncing and snagging the wheel, especially when working corners, sharp edges etc.** This can cause loss of control and kick-back.

**The direction of feed with the bit into the material when carving, routing or cutting is very important. Always feed the bit into the material in the same direction as the cutting edge is exiting from the material (which is the same direction as the chips are thrown).** Feeding the tool in the wrong direction, causes the cutting edge of the bit to climb out of the work and pull the tool in the direction of this feed.

**If the workpiece or bit becomes jammed or bogged down, turn the tool off by the switch. Wait for all moving parts to stop and unplug the tool, then work to free the jammed material.** If the switch of the tool is left on, the tool could restart unexpectedly causing serious personal injury.

**Do not leave a running tool unattended, turn power off.** Only when tool comes to a complete stop it is safe to put it down

**Do not grind or sand near flammable materials.** Sparks from the wheel could ignite these materials.

**Do not touch the bit or collet after use.** After use the bit and collet are too hot to be touched by bare hands.





**Regularly clean the tool's air vents by compressed air.** Excessive accumulation of powdered metal inside the motor housing may cause electrical failures.

**Do not allow familiarity gained from frequent use of your rotary tool to become commonplace.** Always remember that a careless fraction of a second is sufficient to inflict severe injury.

**Do not alter or misuse tool.** Any alteration or modification is a misuse and may result in serious personal injury.

## Symbols

Important: Some of the following symbols may be used on your tool. Please study them and learn their meaning. Proper interpretation of these symbols will allow you to operate the tool better and safer.

Symbol	Name	Designation/Explanation
V	Volts	Voltage (potential)
A	Amperes	Current
Hz	Hertz	Frequency (cycles per second)
W	Watt	Power
kg	Kilograms	Weight
min	Minutes	Time
s	Seconds	Time
∅	Diameter	Size of drill bits, grinding wheels, etc.
$n_0$	No load speed	Rotational speed, at no load
.../min	Revolutions or reciprocation per minute	Revolutions, strokes, surface speed, orbits etc. per minute
1, 2, 3, ...	Selector settings	Speed, torque or position settings. Higher number means greater speed
	Infinitely variable selector	Speed is increasing from narrow end
	Arrow	Action in the direction of arrow
	Alternating current	Type or a characteristic of current
	Class II construction	Designates Double Insulated Construction tools

## Legend

- 1 Speed control button
- 2 ON - OFF - switch
- 3 Hanger
- 4 Mains supply cable
- 5 Locking button
- 6 Cap nut with steel clamp jaw
- 7 Fitting collar for clamping  $\frac{3}{4}$ " (20 mm)
- 8 Steel clamping jaws
- 9 Open end spanner

## Functional Description:

The PROXXON professional grinder IBS/E is the ideal machine for fine milling, grinding, polishing, brushing, derusting, engraving,

**This product is not intended for use as a dental drill or in medical applications.** Serious personal injury may result.

**When using steel saws, cut-off wheels, high speed cutters or tungsten carbide cutters, always have the work securely clamped. Never attempt to hold the work with one hand while using any of these accessories.** The reason is that, these wheels will grab, if they become slightly canted in the groove, and can kick-back causing loss of control resulting in serious injury. Your second hand should be used to steady and guide the hand holding the tool. When a cut-off wheel grabs, the wheel itself usually breaks. When the steel saw, high speed cutters or tungsten carbide cutters grab they may jump from the groove and you could lose control of the tool.

ing, engraving and cutting. You may use this machine with steel, non-ferrous metal, glass, wood, minerals and Ceramics. The spindle is fitted with a high precision ball bearing and runs without clearance in the die-cast aluminum housing. The quiet running, special motor with electronic speed control ensures maximum power with small constructive dimensions. Compact housing made of glass-fibre reinforced nylon with a  $\frac{3}{4}$ " (20mm) collar on the aluminum section of the housing. The steel clamping jaws, which come with the machine, are designed for quick and easy changing of tools and ensure far better true running properties, than a normal chuck.

## Warning!

Use this tool only for the application it has been designed for! For your own safety:  
This tool is not recommended for drilling in concealed areas.

## Technical data

Length:	approx. 9" (250 mm)
Weight:	approx. 1,1lb (500g)
Collar:	Ø 3/4" (20 mm)
Motor	
Voltage:	115 V~, 50-60 Hz
Rotary speed:	5,000 - 20,000 rpm
Characteristic noise emission	≤ 70 dB (A)
Noise level may exceed 85 dB(A) during operation.	
Ear protection must be worn!	
Vibration at handle	≤ 2.5 m/s <sup>2</sup>

## Operation:

### Clamping, changing the tool

#### **Warning!**

Pull the mains plug out before changing tools. Do not press the locking button (arrow fig. 2) as long as the machine is running.

1. Turn the cap nut 1 (fig. 2) slightly and press the locking button at the same time, until it engages. Loosen the nut for a few turns and change the tool. Use the open end spanner if the tool is clamped tight.

#### **Note:**

Clamp the tool as short as possible. Excessively protruding shanks will easily bend and cause erratic running.

### Working with the machine

#### **Warning!**

Do not work without protective goggles. Do not work with damaged grinding bits or bent shanks. Always wear a breather mask under extremely dusty conditions or in case of hazardous dusts.

1. Switch the machine on with the switch 2 (fig. 1) and adjust the appropriate speed for the work with the button (1).

#### **Note:**

High grinding performance is the result of correct and even rotary speed and not of excessive pressing power.

Small milling / grinding bits = high speed,  
Large milling / grinding bits = low speed.

2. For engraving work hold the machine like a ball pen (fig. 3) and do not cover the ventilation slots with your hand.
3. For rough work hold the machine like a hammer (fig. 4). The grinder IBS/E has an ergonomic design, so that it can be easily guided at the fitting collar. The thread for

the cap nut is lowered into the machine housing. The use of a chuck is therefore not possible.

## Maintenance :

#### **Warning!**

Disconnect the plug from the mains before performing any maintenance or cleaning work.

#### **After use**

Clean the unit thoroughly, removing all grinding dust with a brush or a soft cloth. Ensure all ventilation slots are free from obstruction.

The power cord shall be replaced by part no. 38481-23 only, if the cord is damaged.

## Operations Speeds for Accessories

Your tool is equipped with an electronic feedback system, that's help to keep the preselected rotating speed virtually constant between no-load and load conditions

#### **WARNING!**

An external speed control should never be used with this tool.

The following table shows you the recommended speed for different accessories, available from PROXXON.

#### **WARNING!**

Only use accessories and spare parts recommended by PROXXON (Observe the max. permitted rotational speed).

### Accessories available from PROXXON MICROMOT – Steel Collets (Art.-No. 28940)

6 collets in sizes:

1/32" = 1,0 mm	1/16" = 1,5 mm
5/64" = 2,0 mm	3/32" = 2,4 mm
7/64" = 3,0 mm	1/8" = 3,2 mm

	recommended speed	maximum speed
Brass Brushes (No. 28960, 28962)	12.000 rpm	15.000 rpm
Grinding wheels		
-Aluminiumoxide (No. 28302)	20.000 rpm	30.000 rpm
-Silicon carbide (No. 28304)	20.000 rpm	30.000 rpm
Metal cutting blades (No. 28830)	15.000 rpm	20.000 rpm
Cut-off wheels (Corundum) (28810)	20.000 rpm	20.000 rpm
Aluminiumoxide grinding bits (No. 28770)	20.000 rpm	80.000 rpm
Milling bit (Tungsten vanadium, ø 2,3mm)	20.000 rpm	20.000 rpm
Diamond grinding bit (No. 28222)	20.000 rpm	150.000 rpm

All shanks 3/32" (2,4 mm)

## Replacement Parts List

---

Please order spare parts in writing from Proxxon Service center  
(Address on the back of this manual)

### Professional grinder IBS/E

#### No. 38481

Part No	Designation	Part No	Designation
28481 - 01	Cap nut	28481 - 24	Spanner
28481 - 02	Clamping jaws (accessories)	28481 - 25	Centering ring
28481 - 03	Circlip	28481 - 27	Motor housing
28481 - 04	Wave washer	28481 - 28	Support ring
28481 - 05	Spacer ring	28481 - 29	Rear housing cover
28481 - 06	Ball bearing	38481 - 97	Packaging
28481 - 07	Circlip	38481 - 99	Operating Instructions
28481 - 08	Shaft		
28481 - 09	Front part of housing with locking button		
28481 - 10	Motor fastening screws		
28481 - 12	Locking button		
28481 - 13	Fan		
28481 - 15	Housing screw		
28481 - 16	Control knob		
28481 - 17	Switch		
38481 - 19	Motor incl. pinion		
38481 - 20	Control unit		
28481 - 22	Handle		
38481 - 23	Power cable incl. plug and grommet		

## LIMITED WARRANTY OF PROXXON POWER TOOLS FOR HOME USE

Prox-Tech, Inc., ("Seller") warrants to the original purchaser only, that all PROXXON consumer power tools will be free from defects in material or workmanship for a period of two years from the date of purchase. Seller's sole obligation and your exclusive remedy under this limited warranty and, to the extent permitted by law, any warranty or condition implied by law, shall be the repair or replacement of parts, without charge, which are defective in material or workmanship and which have not been misused, carelessly handled, or misrepaired by persons other than Seller or Authorized Service Station. In the event of a failure of a product to conform to this written warranty, please refer to the Service and Repair section on the back of this manual and take action accordingly.

This Limited Warranty does not apply to accessory items such as circular saw blades, drill bits, router bits, jigsaw blades, sanding belts, grinding wheels and other related items. Damage to the product resulting from tampering, accident, abuse, negligence, unauthorized repairs or alterations, unapproved attachments or other causes unrelated to problems with material or workmanship are not covered by this warranty.

Any implied warranties shall be limited in duration to two years from date of purchase. Some states in the U.S. and some Canadian provinces do not allow limitations on how long an implied warranty lasts, so the above limitation may not apply to you.

In no event shall seller be liable for any incidental or consequential damages (including but not limited to liability for loss of profits) arising from the sale or use of this product. Some states in the U.S. and some Canadian provinces do not allow the exclusion or limitation of incidental or consequential damages; so the above limitation or exclusion may not apply to you. This limited warranty gives you specific legal rights, and you may also have other rights, which vary from state to state in the U.S., province to province in Canada and from country to country. This limited warranty applies only to PROXXON power tools sold within the United States of America, Canada, the commonwealth of Puerto Rico and Mexico. For warranty coverage within other countries contact your local PROXXON importer.



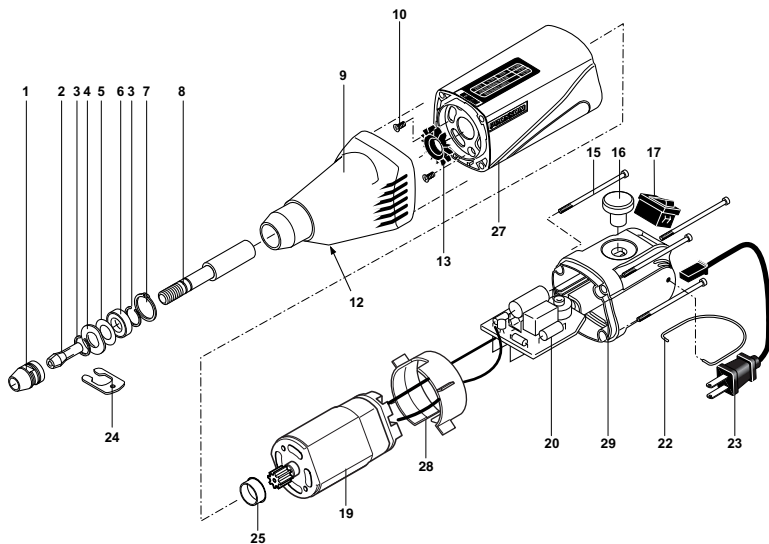

# PROXXON

## SERVICE AND REPAIR

Your device does not work properly? Please read the operating instructions again carefully. If the unit is in fact defective, please send it to:

**Prox-Tech, Inc.**  
**Attn.: PROXXON Service Center**  
**2555 Tate Blvd. S.E.**  
**PO Box 1909**  
**Hickory, NC 28603-1909**

Please make sure, that your tool is **carefully packaged** and include a copy of your **dated proof of purchase**. You will help us to react even quicker, if you describe the problem in short and please **don't forget to include your name, address and daytime telephone number**. We will respond in a prompt and reliable manner.

## Spare Parts

You can also order any necessary **spare parts** from our Service Center at the above address. Please check the **article-number** of the tool concerned on the nameplate of the tool and define the part needed by using the **explosion drawing** in the manual that came with the tool. **Every part has a specific number** (5 digit-XX). Please provide us with this number when ordering.

For any further information call us toll free at **1-877-PROXXON** (1-877-776 9966) or visit us on the web at [www.proxxon.com/us](http://www.proxxon.com/us).

Art.-Nr. 38481-99 PR 703712702 J