

Parkland Heritage®

ASSEMBLY AND OPERATING INSTRUCTIONS

Produced Exclusively by D.C. America

(Fits Model LQGO19323MBR-BB 10'x10'THREE TIER GAZEBO)



CORPORATE OFFICE:

P.O. Box 660999 Arcadia, CA 91006

1-800-238-LAWN (5296)

Monday thru Friday, 8:30 AM to 4:30 PM, PST

Parkland Heritage®

is a trademark of D.C. America. All rights reserved.

Read Manual

Your Gazebo requires assembly prior to use. It is important that you read the entire manual and become familiar with the unit **BEFORE** you set up the Gazebo.

Safety Warning and Precautions

WARNING: When using product, basic safety precautions should always be followed to reduce the risk of personal injury and damage to equipment.

Read all instructions before assembling and using this product.











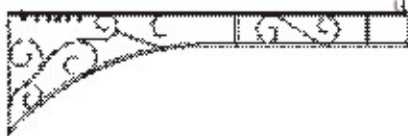
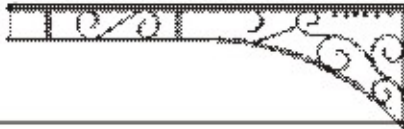

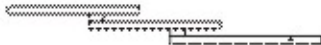

- 1. Select ideal location.** Set out all parts on a clear and level surface prior to assembly. Ideally, the Gazebo should be set up in the desired location to avoid moving it after assembly.
- 2. Use caution.** During the assembly process, especially when lifting heavy or large parts, pay attention to safety. Only those assembling the product should be allowed in the work area.
- 3. Tools and Assistance.** Ladder and wrench are self-provided. Whenever possible, assistance is preferred.
- 4. Check for parts available.** Before assembling your Gazebo, make sure that you have all parts described in the Parts List on page 3.
- 5. Check for damaged parts.** Before assembling your Gazebo, check for damaged parts. Any part that appears damaged should be carefully checked to determine if it can operate properly and perform its intended function. Any part that is damaged should be properly repaired or replaced by a qualified technician.
- 6. Refer to assembly diagram.** During assembly, it is helpful to refer to the assembly diagrams provided.
- 7. Keep children away.** Children should be kept away from the work area. Do not allow children to handle any parts or tools. No one other than the assemblers shall be allowed in the work area.
- 8. Please keep this Assembly Instruction for future use.**

MANUFACTURER RECOMMENDATION:

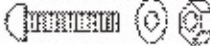
1. ALL STEEL FURNITURE HAS THE POTENTIAL FOR RUST IF THE PAINT IS SCRATCHED AND BAR METAL IS EXPOSED TO AIR AND WATER. APPLY CLEAR RUST INHIBITOR IMMEDIATELY AFTER ASSEMBLING THE FURNITURE TO PREVENT RUSTING.

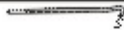
2. IT IS RECOMMENDED TO REMOVE CANOPY TOP DURING INCLEMENT WEATHER.

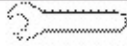
Parts List

Part#	Description	Figure	Qty
SA	Post		4
SB1	Lintel		4
SB2	Lintel		4
SC	Long Top Supporting Tube		4
SD	Short Top Supporting Tube		4
SF	Center Connector		1
SG	Canopy (Item# GOT323-BR)		1
SG	Middle-Top Canopy (Item# GOT323-BR)		1
SG	Small-Top Canopy (Item# GOT323-BR)		1
SH	Netting (Item# GOS1323-BR)		4
SL1	Bolt (M6*15)、Washer、Nut		8
SL2	Bolt (M6*35)、Washer、Nut		8
SL3	Bolt (M6*15)、Washer		16
SL	Stake		12
SJ	Plastic Nut Cap		16
SK	Wrench		1
SR	Wrench		1

Assembly Steps:

1. Attach Lintels (SB1) to Lintels (SB2) using bolt (SL1). Connect the installed Lintels to (SA) Posts with Bolt (SL3). (Note: The Slide Rail should be facing outside of the frame)

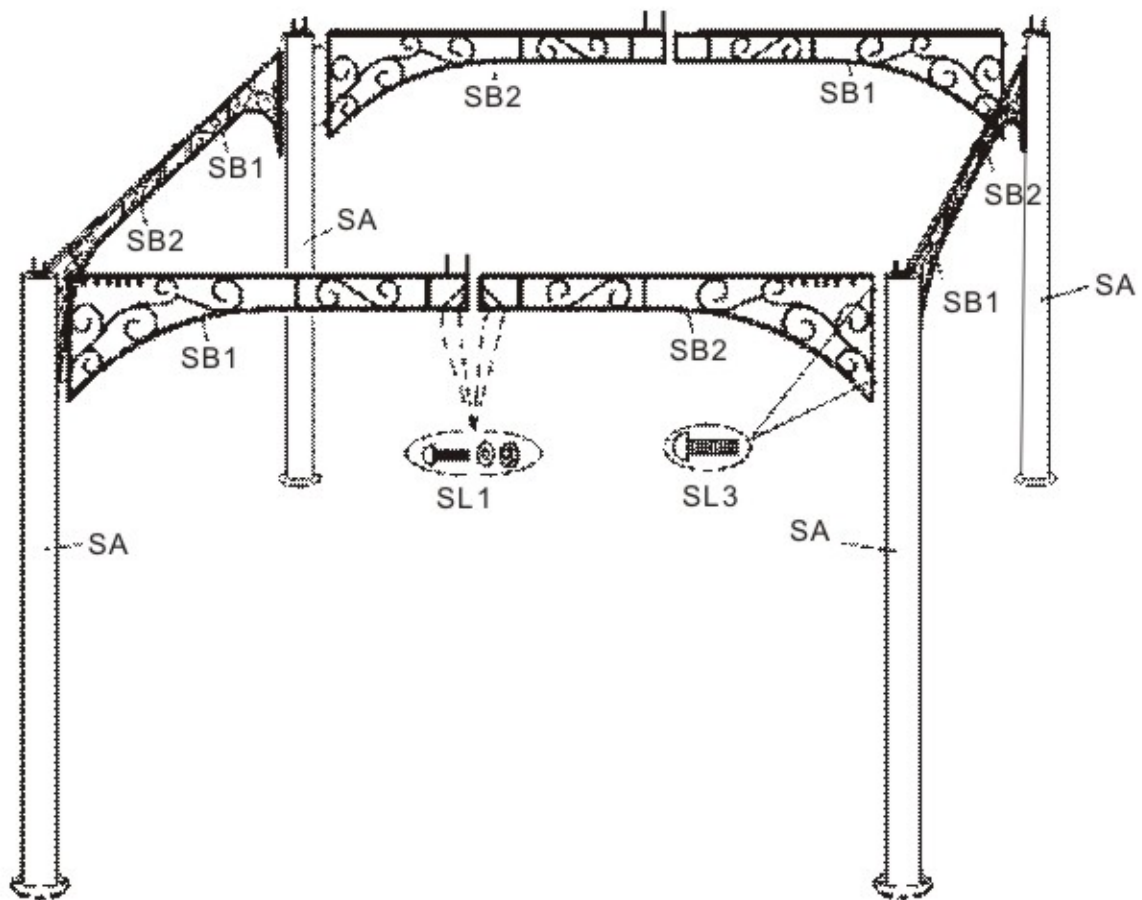

Figure 1 Frame Assembly

- 2、 Insert Long Top Supporting Tube(SC) with short Top Supporting Tube (SD) into center Connector (SF).
See Diagram (2)

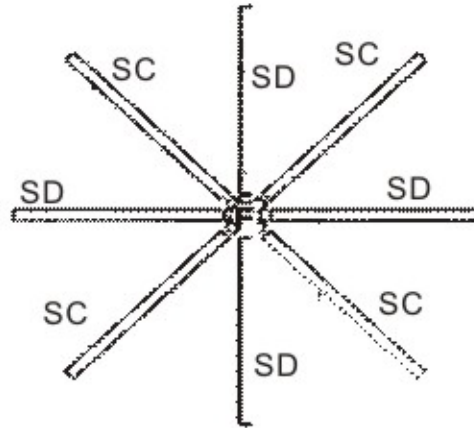

Figure 2 Top Frame Assembly

- 3、 Attach Long Top Supporting Tubes (SC) to (SA) Posts with (SL2) Bolts. Attach Short Top Supporting Tubes (SD) to connected (SB1) Lintels with (SL2) Bolts, as shown in Figure 3.

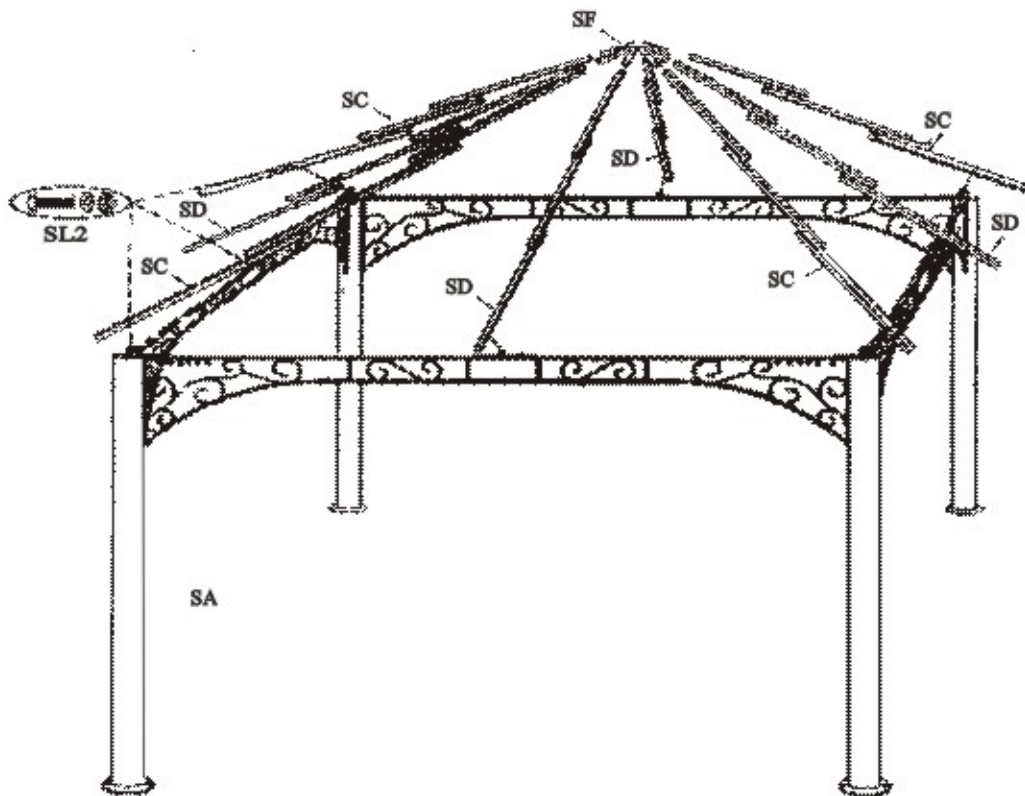

Figure 3 Top Frame Assembly

- 4、 Cover the Gazebo frame with Canopy (SG) at the bottom, Middle-Top Canopy (SG) in the middle, and Small-Top Canopy (SG) at the very top, making sure they are resting on already assembled Long and short Supporting tubes. Line up fabric knots of each canopy tier with ridges of Supporting Tubes, as shown in Diagram 4.

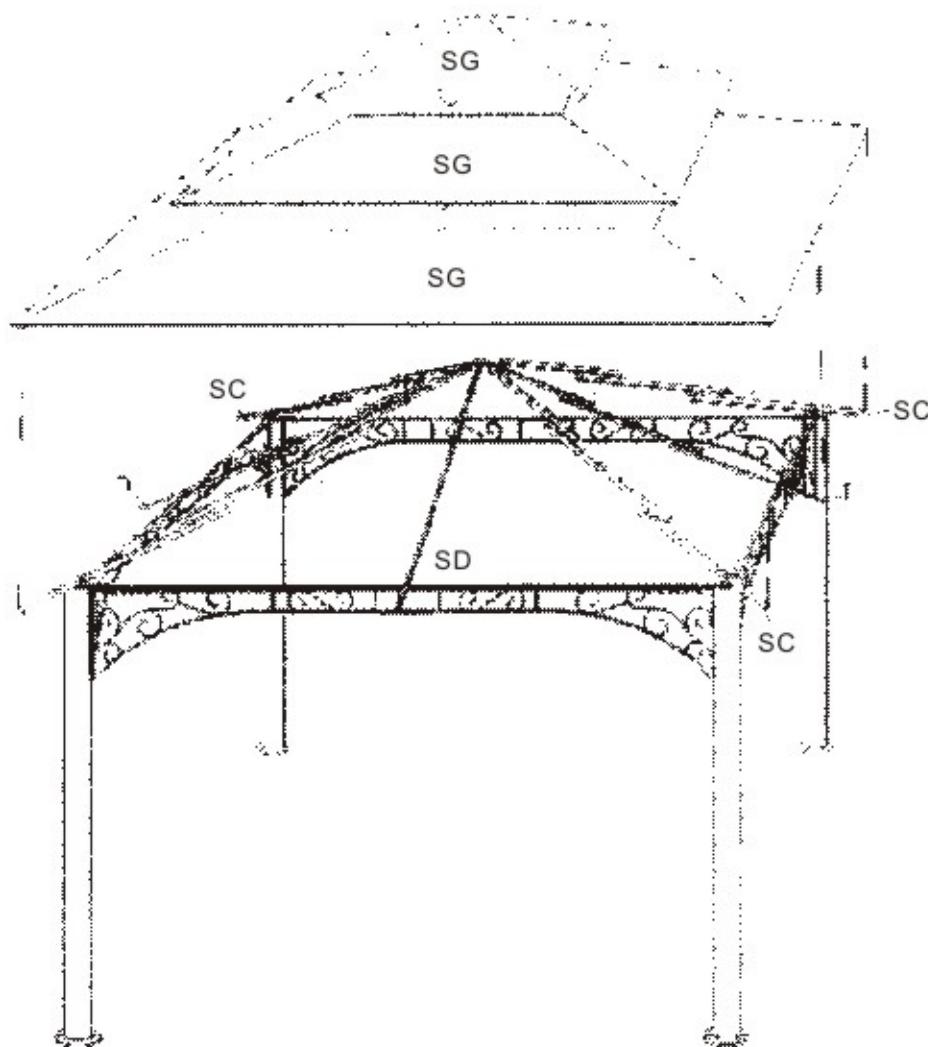

Figure 4 Cover Assembly

5. Cover all Nuts with Plastic Nut Caps (SJ). Secure Gazebo to desired area by inserting Stake (SI) into holes of Post(SA).

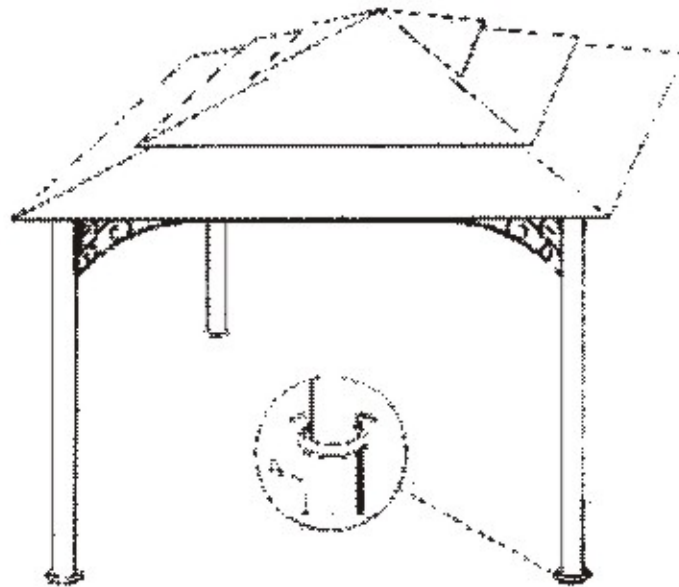
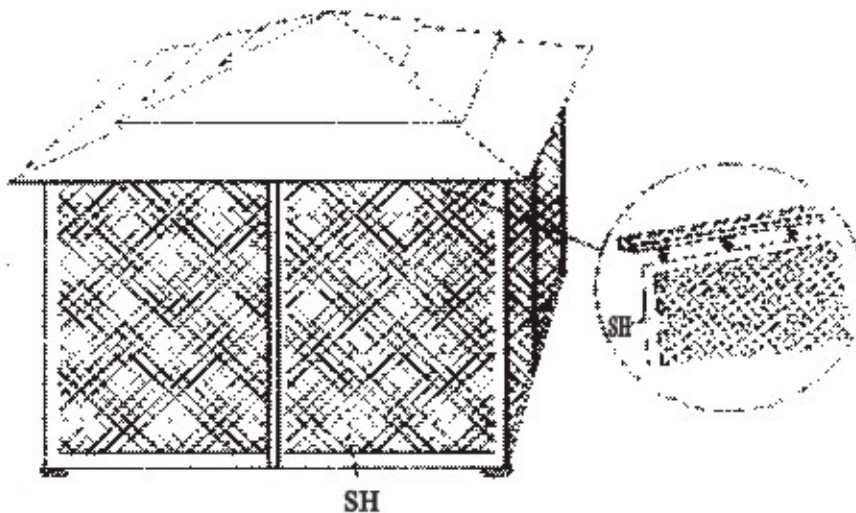

Figure 5 Gazebo Diagram

6. Hang Netting (SH) onto the Slide Rail of Lintels for all four sides of Gazebo. Your Gazebo is now ready for use.



SH
Figure 6 Scroon Assembly
Screen Should be placed Outside

(Note: As an option, Netting (SH) can be drawn back using straps provided.)

Parkland Heritage® TRADEMARK AND ASSEMBLY INSTRUCTION PRESENTATION ARE PROPERTIES OF D.C. AMERICA AND ARE PROTECTED UNDER U.S. COPYRIGHT AND TRADEMARK LAWS