

Shark[®]

OWNER'S GUIDE

V2950

www.sharkclean.com

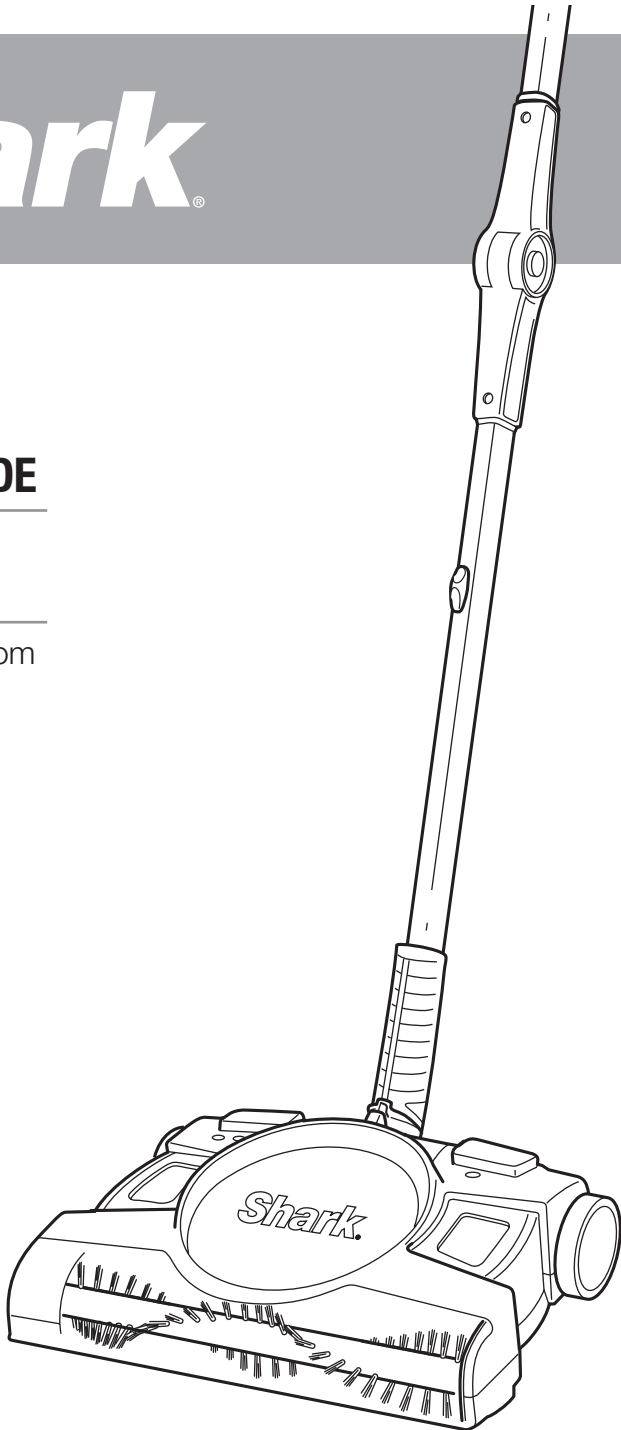

IMPORTANT SAFETY INSTRUCTIONS

For Household Use Only

READ ALL INSTRUCTIONS BEFORE USING YOUR SHARK® CORDLESS FLOOR AND CARPET SWEEPER.

WHEN USING YOUR SHARK CORDLESS FLOOR AND CARPET SWEEPER, BASIC SAFETY PRECAUTIONS SHOULD ALWAYS BE OBSERVED, INCLUDING THE FOLLOWING:

WARNING: TO REDUCE THE RISK OF FIRE, ELECTRIC SHOCK OR INJURY:

- 1 Read all label, operational and marking instructions before using the appliance.
- 2 Use **ONLY** as described in this manual. Use only manufacturer's recommended attachments.
- 3 To reduce the risk of injury, **DO NOT** allow to be used as a toy. Close attention is necessary when used by or near children.
- 4 **DO NOT** use for any purpose other than described in this user's guide.
- 5 **DO NOT** use with damaged cord or plug. Do not use the cordless floor and carpet sweeper if it has been dropped, damaged, left outdoors, or dropped in water. Return it to EURO-PRO Operating LLC for examination, repair or adjustment.
- 6 **DO NOT** abuse the charger cord. Never carry the charger or base by the cord or yank to disconnect from an outlet; instead grasp the charger and pull to disconnect.
- 7 Keep the charger cord away from heated surfaces.
- 8 **DO NOT** use the charger with an extension cord. Plug the charger directly into an electrical outlet. Use charger only in a standard electrical outlet.
- 9 **DO NOT** attempt to use the charger with any other product or attempt to charge this product with another charger. Use only the charger model **YLS0041-T110025** supplied with this cordless floor and carpet sweeper.
- 10 **DO NOT** charge this unit outdoors.
- 11 **DO NOT** use outdoors or on wet surfaces.
- 12 **DO NOT** handle plug or appliance with wet hands.
- 13 Use only on dry, indoor surfaces.
- 14 **DO NOT** put any object into openings. Do not use with brush roll blocked; keep free of fiber, lint, hair and anything that may prevent the brush roll from working.
- 15 Keep hair, loose clothing, fingers and all parts of body away from openings and moving parts.
- 16 **DO NOT** pick up anything that is burning or smoking, such as cigarettes, matches or hot ashes.
- 17 **DO NOT** use to pick up flammable or combustible liquids such as gasoline or use in areas where they may be present.
- 18 **DO NOT** attempt to change accessories while the unit is running.
- 19 **DO NOT** use the cordless floor and carpet sweeper without the dust cup in place.
- 20 Use extra care when cleaning on stairs.
- 21 Store the cordless floor and carpet sweeper indoors. Store after use to prevent accidents.
- 22 Leaks from battery cells can occur under extreme conditions. If the liquid, which is 20-35% solution of potassium hydroxide, gets on the skin - wash immediately with soap and water or neutralize with a mild acid such as lemon juice or vinegar. If the liquid gets into the eyes, flush them immediately with clean water for a minimum of 10 minutes and seek medical attention.
- 23 This product includes rechargeable nickel metal hydride batteries. Batteries must be recycled or disposed of properly. Do not incinerate the batteries or expose to high temperatures as they may explode.
- 24 The cordless floor and carpet sweeper must be disconnected from the power supply when removing the battery.
- 25 To reduce the risk of electrical shock, do not put the charger and sweeper body in water or other liquid. Do not place or store the appliance where it can fall or be pulled into a tub or sink.



**TO MAXIMIZE THE LIFE OF YOUR
NI-MH BATTERIES:**

- 1 Charge for 7 hours before initial use. Failure to do so will reduce the product's battery life significantly.
 - 2 Always remove the charging adapter from the unit after the charging period has completed.
 - 3 Do not store the unit with the charging adapter attached and plugged in.
 - 4 For maximum battery life, only recharge the unit when the batteries are close to fully discharged. It is best to fully discharge the batteries at least once a month.
 - 5 **DO NOT** store in areas of high temperature or humidity.
 - 6 After 3 months of non-use, the product should be fully discharged and then recharged to maximize battery power.
 - 7 Ni-MH batteries have a long useful life but at some time they will need to be replaced. To purchase replacement batteries, visit www.sharkclean.com.
- ⚠ NOTE:** The On/Off switch must be in the "Off" position in order to charge the unit. If the charging indicator does not light, press the On/Off button once.

Warning: Changes or modifications to this unit not expressly approved by the party responsible for compliance could void the user's authority to operate the equipment.

Note: This equipment has been tested and found to comply with the limits for a Class B digital device, pursuant to Part 15 of the FCC Rules. These limits are designed to provide reasonable protection against harmful interference in a residential installation. This equipment generates, uses and can radiate radio frequency energy and, if not installed and used in accordance with the instructions, may cause harmful interference to radio communications.

However, there is no guarantee that interference will not occur in a particular installation. If this equipment does cause harmful interference to radio or television reception, which can be determined by turning the equipment off and on, the user is encouraged to try to correct the interference by one or more of the following measures:

- Reorient or relocate the receiving antenna.
- Increase the separation between the equipment and receiver.
- Connect the equipment into an outlet on a circuit different from that to which the receiver is connected.
- Consult the dealer or an experienced radio/TV technician for help.

This device complies with Part 15 of the FCC Rules. Operation is subject to the following two conditions: (1) This device may not cause harmful interference, and (2) this device must accept any interference received, including interference that may cause undesired operation.

SAVE THESE INSTRUCTIONS

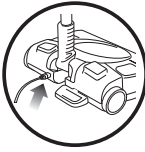

IMPORTANT: Before you can start using your new cordless floor and carpet sweeper, you'll need to charge it for 7 hours.

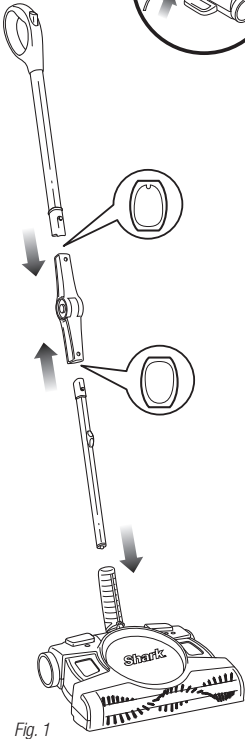

Fig. 1



Fig. 2

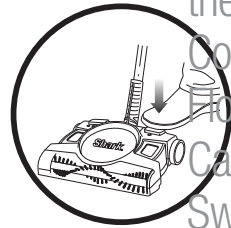

Fig. 3

Thank you
for purch
the Shar
Cordless
Floor and
Carpet
Sweeper

ASSEMBLE

- 1 Assemble the upper and lower handle into the elbow joint to form the Shark® Backsaver™ folding handle. Then insert it into the base of your cordless floor and carpet sweeper. (fig. 1)

CLEAN

- 2 Pull back on the handle and press lightly on the body of the unit with your foot to engage the steering. (fig. 2)
- 3 Using your foot, press the On/Off button and push your cordless floor and carpet sweeper forward over the surface you wish to clean. (fig. 3)
- 4 Press the speed button on the right with your foot to change the speeds. One light indicates the speed optimized to clean bare floors and two lights indicate the speed optimized to clean carpets and larger debris on bare floors.

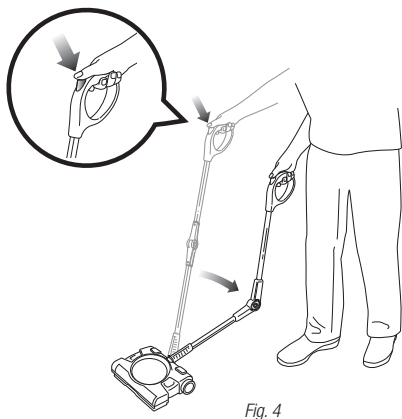

Fig. 4

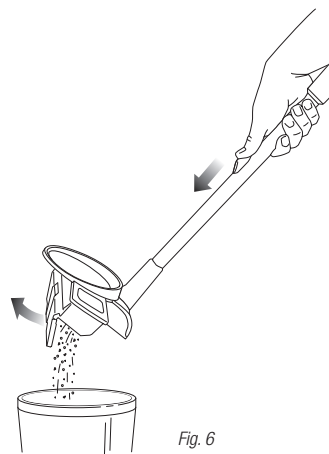

Fig. 6

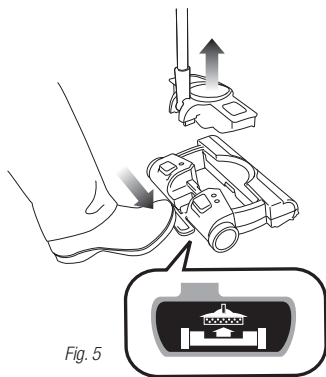

Fig. 5

EMPTY

- 5 The Shark® Backsaver™ folding handle makes cleaning under furniture a breeze. Just press the button on the handle with your thumb to engage the Shark® Backsaver™ function. (fig. 4)
- 6 When you're finished cleaning, empty the No-Touch dust cup. Simply press the dust cup release pedal and lift out the dust cup. (fig. 5)
- 7 Over a trash can, empty the dust cup by pressing the bottom-empty button on the lower portion of the handle. When it's empty, gently snap the No-Touch dust cup back into place. (fig. 6)

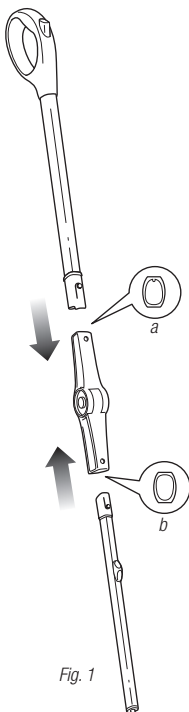
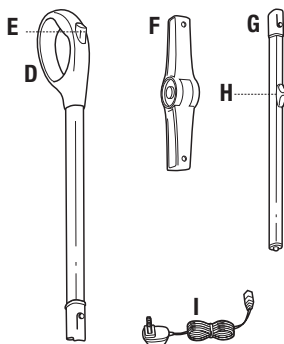
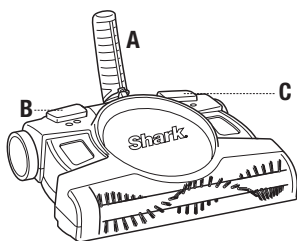

Fig. 1

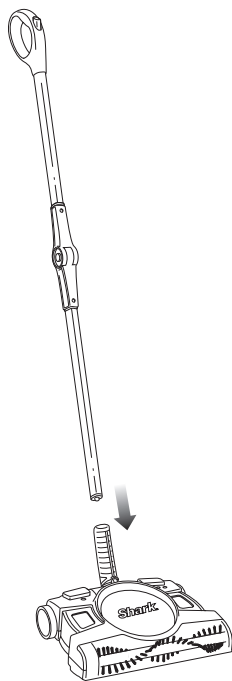

Fig. 2

COMPONENTS:

- A** Floor and Carpet Sweeper Base
- B** Speed Control Button
- C** On/Off Button
- D** Upper Pole with Handle
- E** Backsaver™ Release Button
- F** Shark® Backsaver™ Joint
- G** Lower Pole
- H** Dust Cup Empty Lever
- I** Charging Adapter

Model Number: V2950 32

Voltage: 7.2V

ASSEMBLY OF YOUR FLOOR AND CARPET SWEEPER:

- 1** Slide the upper pole (the tube with the handle) into the end of the Shark® Backsaver™ joint that has a small notch in it (**a**). Then slide the lower pole into the other end of the joint (**b**). Push it in until it clicks into place. (**fig. 1**)

- 2** Insert the Shark® Backsaver™ folding handle you just assembled into the base. You should hear the locking tab click into place. (**fig. 2**)

⚠ IMPORTANT: You must charge the batteries for 7 hours before using the floor and carpet sweeper for the first time. See page 8 for instructions on charging your unit.

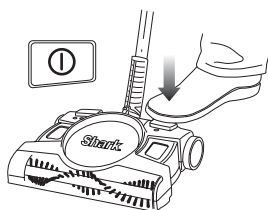

Fig. 3

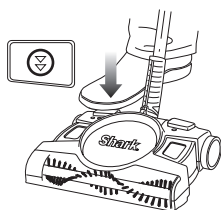

Fig. 4

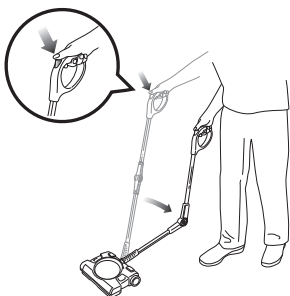

Fig. 5

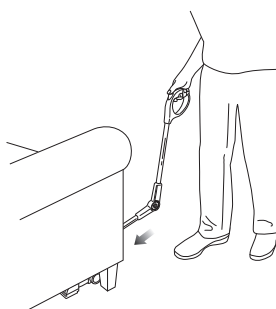



Fig. 6

 If the brush roll stops moving, it's probably due to the anti-jam feature. This feature protects the motor from becoming overheated. If the brush becomes overloaded, it will stop turning and both speed indicator lights will stay on. Turn off your unit by pressing the On/Off button once. Then remove the brush roll cover from the floor and carpet sweeper base and remove any hair or fiber that may be on the brush roll. Wait for 10 seconds to let your unit cool down. Now press the On/Off button again and you're ready to resume cleaning!

See page 9 for further instructions on removing or cleaning the brush roll.

- 1** Press the On/Off button to start the floor and carpet sweeper. The lights on the base will illuminate. When finished cleaning, press the On/Off button again to turn the unit off. (fig. 3)
- 2** You can adjust the speed of the brush roll to suit the floors that you are cleaning. Press the button on the right (opposite the On/Off button) to switch between speeds. One light indicates the speed optimized to clean bare floors and two lights indicate the speed optimized to clean carpets and larger debris on bare floors. (fig. 4)
- 3** To clean under furniture, use the Shark® Backsaver™ folding handle. Press the handle release button and apply a bit of pressure to bend the handle forward. (fig. 5) The Shark® Backsaver™ joint will release from the locked position to reach messes under furniture. (fig. 6)

CHARGING YOUR CORDLESS FLOOR AND CARPET SWEEPER

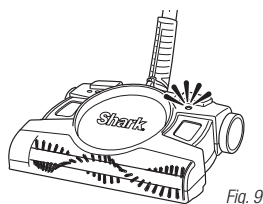
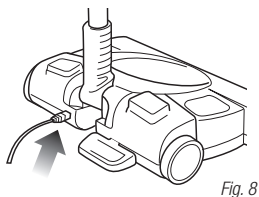
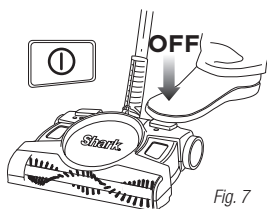

- 1 Always make sure that the unit is turned off. (fig. 7)
- 2 Insert the charger plug into the hole on the back of the floor and carpet sweeper base. (fig. 8) Plug the charger into a wall outlet. The light next to the On/Off button will illuminate when the unit is charging. If the unit is plugged in and the light is not illuminated, press the On/Off button once. The light should now be illuminated indicating that the unit is charging. (fig. 9)
- 3 Let the battery recharge for 7 hours. Your cordless floor and carpet sweeper is powered by Ni-MH batteries that need this time to build up their charge.
- 4 Always remove the charging adapter from the unit after the charging period has completed. Storing the unit with the adapter attached and plugged in will reduce battery life.

! IMPORTANT: Although many adapters look similar, it's important to use only the adapter that came with your floor and carpet sweeper (XA2950).

EMPTYING THE DUST CUP

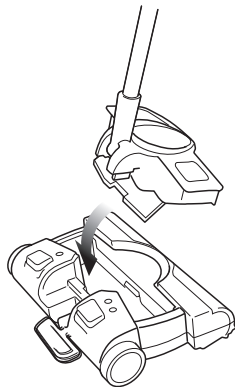
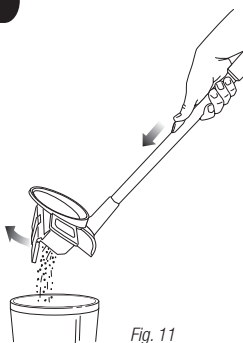
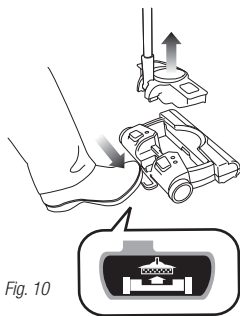

- 1 Press the dust cup release pedal on the floor and carpet sweeper base to remove the No-Touch dust cup. (fig. 10)
- 2 Hold the dust cup over a trash can and push the bottom-empty button located on the lower portion of the handle. The trap door will spring open and release the debris into the trash can. (fig. 11)
- 3 To re-insert the dust cup, position it over the floor and carpet sweeper base and press down gently until it snaps into place. (fig. 12)

💡 For easy insertion into the base, tip the dust cup slightly forward.

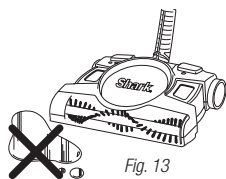

Fig. 13

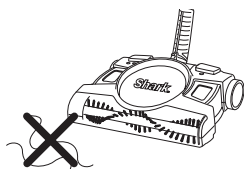

Fig. 14

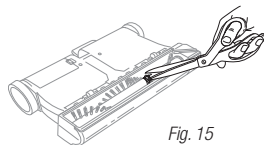

Fig. 15

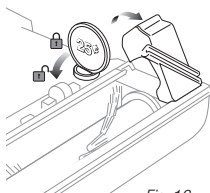

Fig. 16

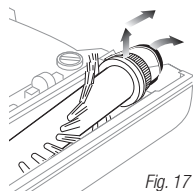

Fig. 17

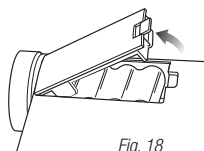

Fig. 18

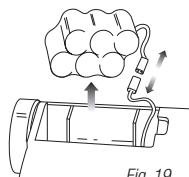

Fig. 19

- 1 Once a month, wipe down your unit with a dry cloth, including the area under the dust cup. Wipe away any hair, fiber or other dirt that may have built up in the chamber and on the rotating brush. Do not use any harsh sweeper or chemicals.
- 2 Do not immerse your floor and carpet sweeper in water or use it to pick up liquids or clean wet floors. (Fig. 13)
- 3 Do not use it on concrete, tar or other rough surfaces.
- 4 Do not use it to pick up pieces of string or fabrics. (fig. 14) Do not use the floor and carpet sweeper to clean tasseled or frayed carpets.

CLEANING THE ROTATING BRUSH

- 1 Press the dust cup release lever with your foot and remove it from the floor and carpet sweeper base. (fig. 10)
- 2 Turn the unit upside down. **Be careful not to accidentally turn the unit on!**

- 3 Remove all hair, strings or fibers wrapped around the brush bar. Using a pair of scissors, carefully cut along the raised guide to remove anything wound around the brush bar. Avoid damaging or cutting the bristles. (fig. 15)
- 4 Use a coin to unlock and remove the trap door. (Fig. 16)
- 5 Carefully lift and remove the brushbar from the belt. (Fig. 17) To reinsert the brushbar, slide the brushbar into the bushing and then place the belt over the ridges of the brushbar cap. Replace the trap door and lock in place.

REMOVING AND REPLACING THE BATTERY

- 1 Press the dust cup release lever with your foot and remove it from the floor and carpet sweeper base. (fig. 10 on page 8)

- 2 Turn the unit upside down. **Be careful not to accidentally turn the unit on!**
- 3 Push in the locking tab and lift off the battery compartment cover. (fig. 18)
- 4 Carefully lift out the battery pack and disconnect the wire terminals by pressing on the latch and pulling apart the wire terminal connectors. Remove the battery pack. (fig. 19)
- 5 Connect the wire terminal from the unit to the wire terminal connector of the new battery pack and replace the battery pack into your unit.
- 6 Follow the instructions on page 8 to charge your new battery pack. Please call customer service at 1-800-798-7398 if you have any problems removing the battery pack.



**NI-MH BATTERY
MUST BE RECYCLED
OR DISPOSED OF
PROPERLY**

TROUBLESHOOTING GUIDE & REPLACEMENT PARTS

PROBLEM

POSSIBLE REASONS AND SUGGESTED SOLUTION

The cordless floor and carpet sweeper will not operate

Batteries need to be recharged.
Batteries are dead and need to be replaced.
There is no power in the electrical outlet being used. Try to charge using a different outlet.
Ensure the wire terminal connectors on the battery pack are securely attached.
Clear any obstruction from the rotating brush.
If your unit still doesn't work, call Customer Service at 1-800-798-7398.

The cordless floor and carpet sweeper will not pick up

Empty the dust container.
Recharge the battery

Dust is escaping from the cordless floor and carpet sweeper

Empty the dust container.

Rotating brush will not pick up

Check for and remove any excessive material on the brush roll or in the bottom of the unit.
Empty the dust container.

The cordless floor and carpet sweeper will not charge

Press the power button once to turn the unit "OFF".
There is no power in the electrical outlet being used. Try to charge using a different outlet.
Ensure the wire terminal connectors on the battery pack are securely attached.
Charging adapter may not be working. Call Customer Service at 1-800-798-7398.
Batteries are dead and need to be replaced

ORDERING REPLACEMENT PARTS

REPLACEMENT PARTS

- A** XB2950 Battery Pack
B XA2950 AC Adapter
C 1123FK-2950 Brush Bar Replacement Kit

To order any of the above replacement parts, go to www.sharkclean.com or call 1-800-798-7398.



EURO-PRO ONE-YEAR (1) LIMITED WARRANTY

EURO-PRO Operating LLC warrants this product to be free from defects in material and workmanship for a period of one (1) year from the date of the original purchase, when utilized for normal household use, subject to the following conditions, exclusions and exceptions.

If your appliance fails to operate properly while in use under normal household conditions within the warranty period, return the complete appliance and accessories, freight prepaid to:

• **U.S.: EURO-PRO Operating LLC**

For customer service support call 1-800-798-7398
or visit www.sharkclean.com

• **Canada: EURO-PRO Operating LLC**

4400 Bois Franc, St. Laurent, Québec H4S 1A7

If the appliance is found to be defective in material or workmanship, **EURO-PRO Operating LLC** will repair or replace it free of charge. Proof of purchase date and \$19.95 to cover the cost of return shipping and handling must be included.*

Non-durable parts including, without limitation, filters, brushes and electrical parts which normally require replacement are specifically excluded from warranty.

The liability of **EURO-PRO Operating LLC** is limited solely to the cost of the repair or replacement of the unit at our option. This warranty does not cover normal wear of parts and does not apply to any unit that has been tampered with or used for commercial purposes. This limited warranty does not cover damage caused by misuse, abuse, negligent handling or damage due to faulty packaging or mishandling in transit. This warranty does not cover damage or defects caused by or resulting from damages from shipping or repairs, service or alterations to the product or any of its parts, which have been performed by a repair person not authorized by **EURO-PRO Operating LLC**.

This warranty is extended to the original purchaser of the unit and excludes all other legal and/or conventional warranties. The responsibility of **EURO-PRO Operating LLC** if any, is limited to the specific obligations expressly assumed by it under the terms of the limited warranty. In no event is **EURO-PRO Operating LLC** liable for incidental or consequential damages of any nature whatsoever. Some states do not permit the exclusion or limitation of incidental or consequential damages, so the above may not apply to you.

This warranty gives you specific legal rights, and you may also have other rights which vary from state to state or province to province.

*** IMPORTANT: Carefully pack item to avoid damage in shipping. Be sure to include proof of purchase date and to attach tag to item before packing with your name, complete address and phone number with a note giving purchase information, model number and what you believe is the problem with item. We recommend you insure the package (as damage in shipping is not covered by your warranty). Mark the outside of your package "ATTENTION CUSTOMER SERVICE". We are constantly striving to improve our products, therefore the specifications contained herein are subject to change without notice.**

PRODUCT REGISTRATION

Please visit www.sharkclean.com or call **1-800-798-7398** to register your new Shark® product within ten (10) days of purchase. You will be asked to provide the store name, date of purchase and model number along with your name and address.

The registration will enable us to contact you in the unlikely event of a product safety notification. By registering you acknowledge to have read and understood the instructions for use, and warnings set forth in the accompanying instructions.

Shark®

Copyright © 2013 Euro-Pro Operating LLC

USA: Newton, MA 02459

CANADA: Ville St-Laurent, QC H4S 1A7

Printed in China

Illustrations may differ with actual product.

V2950 32_130403.5

Euro-Pro and Shark, are trademarks
of Euro-Pro Operating LLC.

www.sharkclean.com

1-800-798-7398