



CONVECTION MICROWAVE GRILL OVEN

Model CMV24

**BEFORE USE, PLEASE READ AND FOLLOW ALL SAFETY RULES
AND OPERATING INSTRUCTIONS. KEEP THIS MANUAL IN A SECURE LOCATION**

Write Serial Number here:

**FELIX STORCH, INC.
770 Garrison Avenue
Bronx, New York 10474**

www.summitappliance.com

Grounding Instructions	3
Important safety instructions	4
Precautions to avoid possible exposure to excessive Microwave energy	6
The advantages of microwaves	9
Description of your oven.....	10
Basic settings	12
Basic Functions	14
Special functions	19
When the oven is working.....	22
Defrosting.....	23
Cooking with a Microwave oven.....	25
Cooking with the Broiler	27
Roasting and baking.....	29
What kind of ovenware can be used?	32
Oven Cleaning and Maintenance.....	34
What should I do if the oven doesn't work?	36
Technical characteristics	37
Installation instructions	38
Installation dimensions	41
Limited Warranty	44

Dear Customer,

Before going any further, we want to thank you for preferring our **SUMMIT** product. We are sure that this modern, functional and practical microwave oven, manufactured with top quality materials, will fully meet your expectations.

We ask you to read the instructions in this booklet very carefully as this will allow you to get the best results from using your microwave oven.

KEEP THE DOCUMENTATION OF THIS PRODUCT FOR FUTURE REFERENCE.

Always keep the instruction manual handy. If you lend the microwave oven to someone else give them the manual as well!

This SUMMIT Microwave Oven complies with Part 18 of the FCC rules

The user manual is also available for download at www.summitappliance.com

GROUNDING INSTRUCTIONS

This appliance must be connected to a grounded, metallic, permanent wiring system, or an equipment grounding conductor should be run with the circuit conductors and connected to the equipment grounding terminal or lead on the appliance.

Warning! IMPROPER USE OF THE GROUNDING CAN RESULT IN A RISK OF ELECTRICAL SHOCK.

Please refer to the Installation Instructions for further information.

IMPORTANT SAFETY INSTRUCTIONS

When using electrical appliances basic safety precautions should be followed, including the following:

Warning! To reduce the risk of burns, electric shock, fire, injury to persons, or exposure to excessive microwave energy:

- Read all instructions before using the appliance.
- Read and follow the specific “PRECAUTIONS TO AVOID POSSIBLE EXPOSURE TO EXCESSIVE MICROWAVE ENERGY” found on this manual.
- This appliance must be grounded. Connect only to properly grounded outlet. See “**GROUNDING INSTRUCTIONS**” found in this manual.
- Install or locate this appliance only in accordance with the provided installation instructions.
- Some products such as whole eggs and sealed containers – for example, closed glass jars are able to explode and should not be heated in this oven.
- Use this appliance only for its intended use as described in the manual. Do not use corrosive chemicals or vapors in this appliance. This type of oven is specifically designed to heat, cook, or dry food. It is not designed for industrial or laboratory use.
- As with any appliance, close supervision is necessary when used by children.
- Do not operate this appliance if it has a damaged cord or plug, if it is not working properly, or if it has been damaged or dropped.
- This appliance should be serviced only by qualified service personnel. Contact nearest authorized service facility for examination, repair, or adjustment.
- Do not cover or block any openings on the appliance.
- Do not store this appliance outdoors. Do not use this product near water – for example, near a kitchen sink, in a wet basement, near a swimming pool, or similar locations.
- Do not immerse cord or plug in water.
- Keep cord away from heated surfaces.
- Do not let cord hang over edge of table or counter.
- When cleaning surfaces of door and oven that come together on closing the door, use only mild, nonabrasive soaps, or detergents applied with a sponge or soft cloth.

IMPORTANT SAFETY INSTRUCTIONS

To reduce the risk of fire in the oven cavity:

- Do not overcook food. Carefully attend appliance when paper, plastic, or other combustible materials are placed inside the oven to facilitate cooking.
- Remove wire twist-ties from paper or plastic bags before placing bag in oven.
- If materials inside the oven ignite, keep oven door closed, turn oven off, and disconnect the power cord, or shut off power at the fuse or circuit breaker panel.
- Do not use the cavity for storage purposes. Do not leave paper products, cooking utensils, or food in the cavity when not in use.
- Liquids such as water, coffee, or tea are able to be overheated beyond the boiling point without appearing to be boiling. Visible bubbling or boiling when the container is removed from the microwave oven is not always present. **THIS COULD RESULT IN VERY HOT LIQUIDS SUDDENLY BOILING OVER WHEN THE CONTAINER IS DISTURBED OR A UTENSIL IS PUT INTO THE LIQUID.**

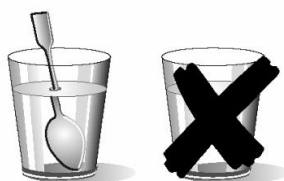

To avoid that type of situation when heating liquids, put a teaspoon or glass rod inside the container.

PRECAUTIONS TO AVOID POSSIBLE EXPOSURE TO EXCESSIVE MICROWAVE ENERGY

- (a) Do not attempt to operate this oven with the door open since open – door operation can result in harmful exposure to microwave energy. It is important not to defeat or tamper with the safety interlocks.
- (b) Do not place any object between the oven front face and the door or allow soil or cleaner residue to accumulate on sealing surfaces.
- (c) Do not operate the oven if it is damaged. It is particularly important that the oven door closes properly and that there is no damage to the: (1) door (bent), (2) hinges and latches (broken or loosened), (3) door seals and sealing surfaces.
- (d) The oven should not be adjusted or repaired by anyone except properly qualified service personnel.

Pacemakers:

Most pacemakers are shielded from interference from electronic products, including microwaves. However, patients with pacemakers may wish to consult their physicians if they have concerns.

Microwave safety



- **Warning!** Never leave the oven unwatched, especially when using paper, plastic or other combustible materials. These materials can char and may catch fire. FIRE RISK!
- **Warning!** Do not heat pure alcohol or alcoholic drinks in the microwave. FIRE RISK!
- **Warning!** Do not heat liquids or other foods in closed containers since these may explode readily.
- **Warning!** This appliance is not intended for use by persons (including children) with reduced physical, sensory or mental capabilities, or lack of experience and knowledge, unless they have been given supervision or instruction concerning use of the appliance by a person responsible for their safety. Children should be supervised to ensure that they do not play with the appliance.
- **Warning!** If the oven has a combined function mode (microwave with other means of heating), children should not be allowed to use the oven without adult supervision on account of the high temperatures generated.
- **Warning!** The oven cannot be used if:
 - The door is not closed correctly;
 - The door hinges are damaged;
 - The surfaces of the contact between the door and the oven front are damaged;
 - The door window glass is damaged;
 - There is frequent electrical arcing inside the oven even though there is no metal object inside.

The oven **can only be used again** after it has been repaired by a Technical Assistance Service technician.

Beware!

- Never heat baby foods or drinks in bottles or jars with the nipples or lids on them. After heating the food mix or shake well so that the heat is spread evenly. Check the food temperature before feeding this to the child. DANGER OF BURNING!
- To avoid food overheating or burning it is very important not to select long time periods or power levels that are too high when **heating small quantities of food**. For example, a bread roll can burn after 3 minutes if the power selected is too high.
- For toasting, use just the broiling function and watch the oven all the time. If you use a combined function to toast bread it will catch fire in a very short time.
- Make sure you never catch the power cables of other electrical appliances in the hot door of the oven. The cable insulation may melt. **Danger of short-circuiting!**

Microwave safety

This oven is exclusively for domestic use!

Use the oven only for preparing meals.

Avoid damaging the oven or other dangerous situations by following these instructions:

- Do not switch on the oven without the **turntable support**, the **turntable ring** and the respective **plate** being in place.
- **Never switch on the microwave when it is empty.** If there is no food inside there may be an electrical overcharge and the oven could be damaged. RISK OF DAMAGE!
- **For carrying out oven programming tests** put a glass of water inside the oven. The water will absorb the microwaves and the oven will not be damaged.
- Use only **dishes suitable for microwaves.** **Before using dishes and containers** in the microwave, check that these are suitable (see the section on types of dishes).
- **Never remove the mica cover on the ceiling of the oven interior!** This cover stops fat and pieces of food damaging the microwave generator.
- Do not keep any **flammable object** inside the oven as it may burn if the oven is switched on.
- Do not use the oven as a **pantry.**
- **Eggs with their shells** and **whole boiled eggs** must not be heated in microwave ovens because they may explode.
- Do not use the oven for **frying** as it is impossible to control the temperature of oil heated by microwaves.
- **To avoid being burnt,** always use oven gloves for handling dishes and containers and touching the oven.
- **Do not lean or sit on the open oven door.** This may damage the oven, especially in the

hinge zone. The door can bear a maximum weight of 8 kg (17.6lbs).

- The turntable and the Broilers can bear a maximum load of 8 kg (17.6lbs). To avoid damaging the oven, do not exceed this load.

Cleaning:

- **Warning!** Your microwave oven must be cleaned regularly. All food remains must be removed (see section on Oven Cleaning). If the microwave oven is not kept clean its surface may deteriorate **and this may** shorten the oven's working life and could even result in a dangerous situation.
- The door contact surfaces (the front of the cavity and the inside part of the doors) must be kept very clean in order to ensure the oven functions correctly.
- Do not use harsh abrasive cleaners or sharp metal scrapers to clean the oven door glass since they can scratch the surface, which may result in shattering of the glass.
- Do not use high pressure or steam jet cleaning appliances.
- Please follow the instructions regarding cleaning in the section "Oven Cleaning and Maintenance".

Repairs:

- **Warning – Microwaves! The outer protection of the oven must not be removed.** It is dangerous for anyone not authorized by the manufacturer to carry out any kind of repair or maintenance work.
- If the power cable is damaged it should be substituted by the manufacturer, authorized agents or technicians qualified for this task in order to avoid dangerous situations. Furthermore, special tools are required for this task.
- Repair and maintenance work, especially of current carrying parts, can only be carried out by technicians authorized by the manufacturer.

The advantages of microwaves

In conventional ovens, heat radiated by electrical elements or gas burners slowly penetrates the food from outside to inside. On account of this a major amount of energy is wasted heating the air, the oven components and the food containers.

In a microwave oven, heat is generated by the food itself and the heat travels from inside to outside. No heat is lost to the air, the walls of the oven cavity or the dishes and containers (if these are suitable for use in microwave oven), in other words, only the food is heated.

Microwave ovens have the following advantages:

1. Shorter cooking times; in general these are up to 3/4 less than the time required for conventional cooking.
2. Ultra-fast food defrosting, thus reducing the danger of bacterial development.
3. Energy savings.
4. Conservation of the nutritional value of foods due to the shorter cooking times.
5. Easy to clean.

How a microwave oven works

In a microwave oven there is a high tension valve called a magnetron which converts electrical energy into microwave energy. These electromagnetic waves are channeled to the interior of the oven through a wave guide and distributed by a metallic spreader or through a turntable.

Inside the oven the microwaves propagate in all directions and are reflected by the metal walls, uniformly penetrating the food.

Why food heats up

Most foods contain water and water molecules vibrate when subjected to microwaves.

The friction between molecules produces heat which raises the temperature of the food, defrosting it, cooking it or keeping it hot.

Since the heat arises inside the food:

- This can be cooked with little or no liquid or fats/oils;
- Defrosting, heating or cooking in a microwave oven is quicker than in a conventional oven;
- The vitamins, minerals and nutritional substances in the food are conserved;
- The natural color and aroma of the food are unchanged.

Microwaves pass through china, glass, cardboard or plastic but do not go through metal. For this reason, metal containers or ones with metal parts must not be used in a microwave oven.

Microwaves are reflected by metal...

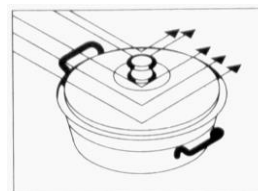

... but go through glass and china...

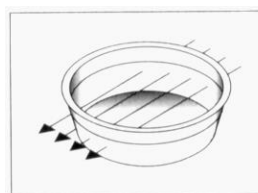

... and are absorbed by foods.

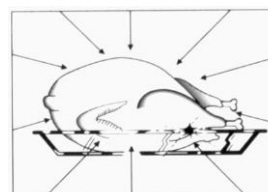

Description of your oven

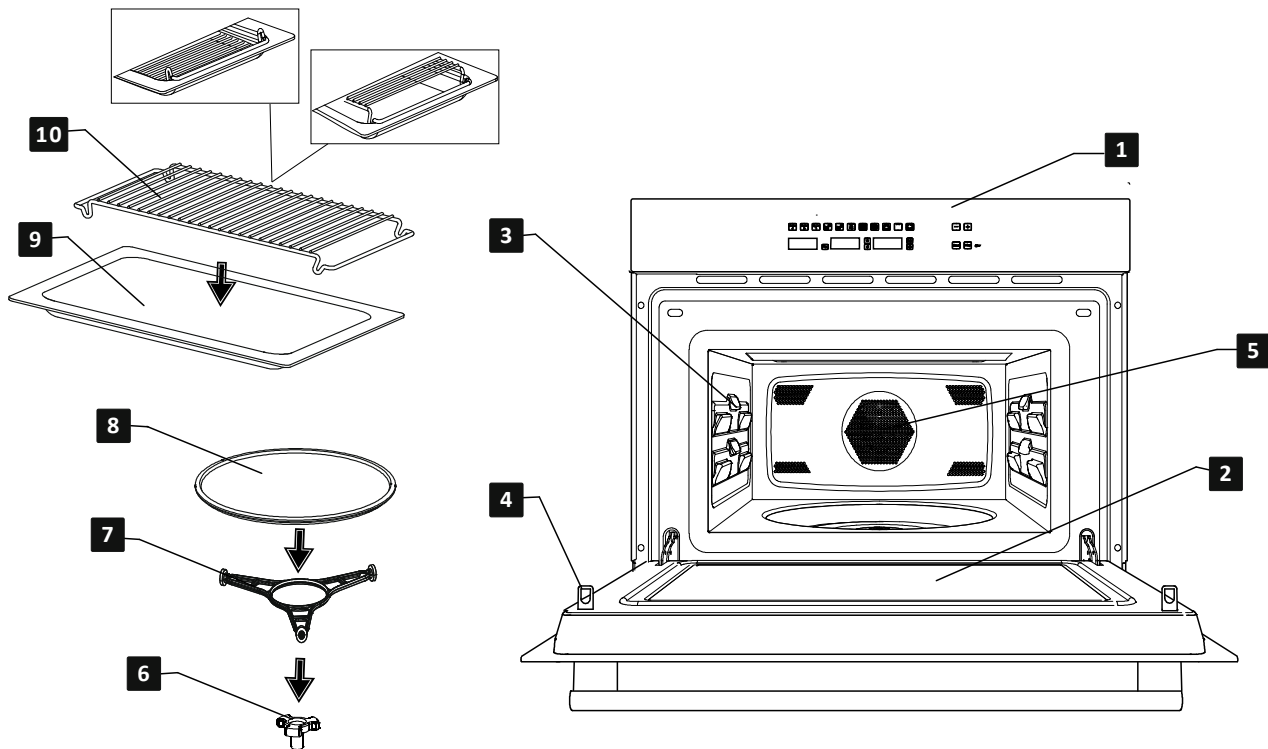



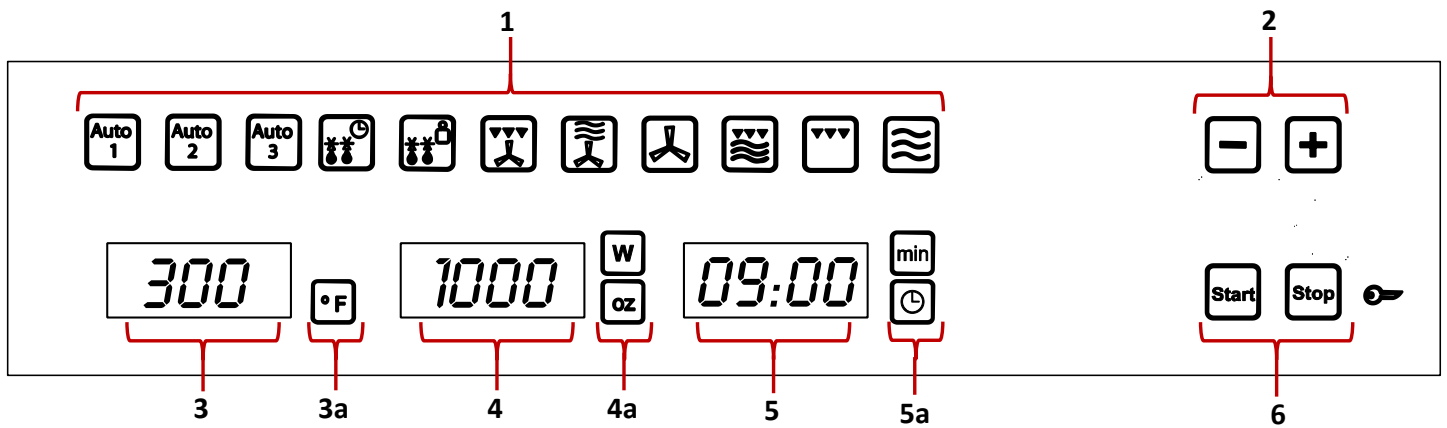







- 1. – Control Panel
- 2. – Door window glass
- 3. – Lateral supports
- 4. – Catches
- 5. – Hot Air output
- 6. – Turntable Support
- 7. – Turntable ring
- 8. – Turntable plate
- 9. – Rectangular Glass Tray
- 10. – Rectangular Rack



- 1. – Function selection keys
- 2. – “+” and “-” keys
- 3. – Oven Temperature selection key
- 3a.- Oven Temperature indication light
- 4. – Power/Weight selection key
- 4a.-Power/Weight indication lights
- 5. – Clock/ Time selection key
- 5a.-Clock/ Time indication lights
- 6. – Start and Stop/ Safety blocking keys

Description of your oven

Description of Functions

Symbol	Function	Microwave Power Output	Foods
	Microwave	200 W	Slow defrosting for delicate foods; keeping food hot.
		400 W	Cooking with little heat; boiling rice. Rapid defrosting, heating baby food.
		600 W	Heating and cooking food.
		800 W	Cooking vegetables and food. Cooking and heating carefully. Heating and cooking small portions of food.
		1000 W	Rapidly heating liquids.
	Microwave + Broiler	200 W	Toasting food
		400 W	Grilling poultry and meat
		600 W	Cooking pies and cheese-topped dishes
	Broiler		Grilling food
	Microwaves + Hot-Air	200-600	Quick meat, fish and poultry roasting. Baking cakes.
	Hot-Air	---	Roasting and baking.
	Broiler + Fan	---	Grilling meat and fish.
			Grilling poultry.
			Potatoes – deep-frozen, defrosting and roasting.
	Defrosting	---	Defrosting by time (manual)
	Defrosting	---	Defrosting by weight (automatic)
	Auto 1	---	Heating food.
	Auto 2	---	Cooking.
	Auto 3	---	Defrosting and toasting.

Basic settings

Setting the clock

After your microwave oven is first plugged in or after a power failure, the clock display will flash to indicate that the time shown is not correct. To set the clock, proceed as follows:



1. Press the **Clock** key for 3 seconds (not necessary on first plug-in or after a power failure). The hour numbers will start to flash.
2. Press key “-” and “+” to set the hours.
3. Press again the **Clock** key to set the minutes. The minute numbers will start to flash.
4. Press key “-” and “+” to set the minutes.
5. To finish, press the **Clock** key again.

Displaying the Clock

To save energy, the clock is normally hidden.

If you want to see the clock, press the **Clock** key briefly and the clock will be visible for 3 seconds.

Safety blocking

The oven operation can be blocked (for example, to stop it from being used by children).



1. To block the oven, press the **Stop** key for 3 seconds. You will hear a sound signal and the **display** will show the word “SAFE”. The oven is blocked in this state and cannot be used.
2. To unblock the oven, press the **Stop** key again for 3 seconds. You will hear a sound signal and the **display** will show the time again.

Basic settings

Stopping the rotating plate



1. To stop the rotating plate, press the “+” key and the “**Stop**” key at the same time
2. To start plate rotation again, press the “+” key and the “**Stop**” key at the same again.

Basic Functions

Microwaves

Use this function to cook and heat vegetables, potatoes, rice, fish and meat.

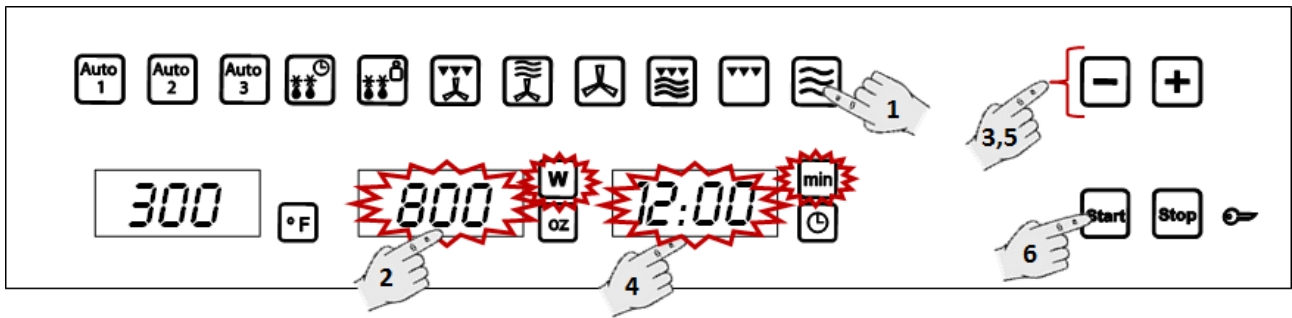

1. Press the Microwave function key. The function key lights up.
2. Press the Power Selection key to change the microwave power. The respective light will start to flash. If you do not press this key, the oven operates at 800 W.
3. To change the microwave power press key “-” and “+”.
4. Press the Time Selection key to change the operating time. The correspondent light will start to flash.
5. Press key “-” and “+”, to change the function time (e.g. 1 minute).
6. Press the START key. The oven will start to operate

NOTE: When 1000 W power is selected, the operating time is limited to a maximum of 15 minutes.

Microwave oven – Quick Start

Use this function to rapidly heat foods with high water content, such as water, coffee, tea or thin soup.

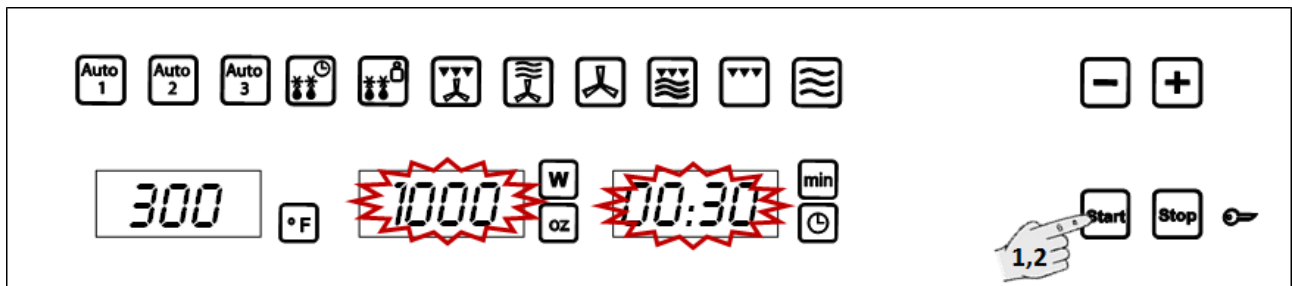

1. Press the **Start** key. The oven starts to operate in the Microwave function at maximum power for 30 seconds.
2. If you want to increase the operating time press the **Start** key again. Each time you press this

key the operating time will be increased by 30 seconds.

NOTE: When 1000 W power is selected, the operating time is limited to a maximum of 15 minutes.

Basic Functions

Broiler

Use this function to brown the top of food quickly.

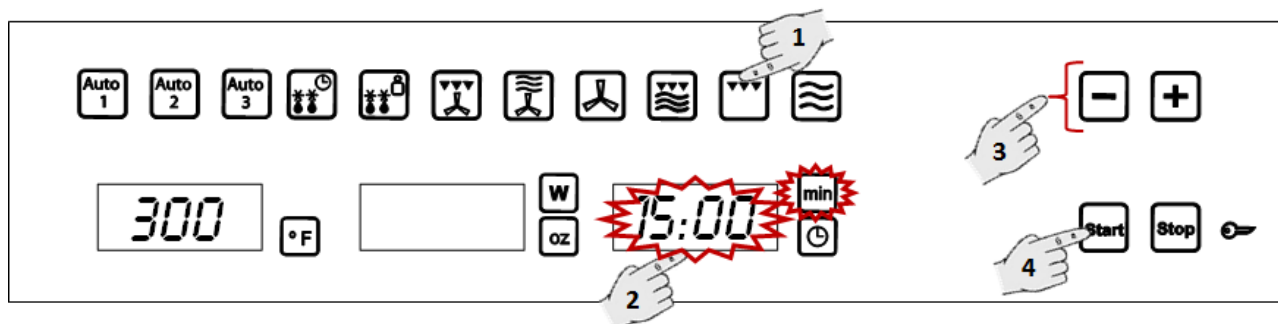

1. Press the function key **Grill**. The function key lights up.
2. Press the **Time Selection** key to change the operating time. The correspondent light will start to flash.
3. Press key “-” and “+”, to change the function time (e.g. 15 minutes).
4. Press the **Start** key. The oven will start to operate.

Microwave + Broiler

Use this function to cook lasagne, poultry, roast potatoes and toasted foods.

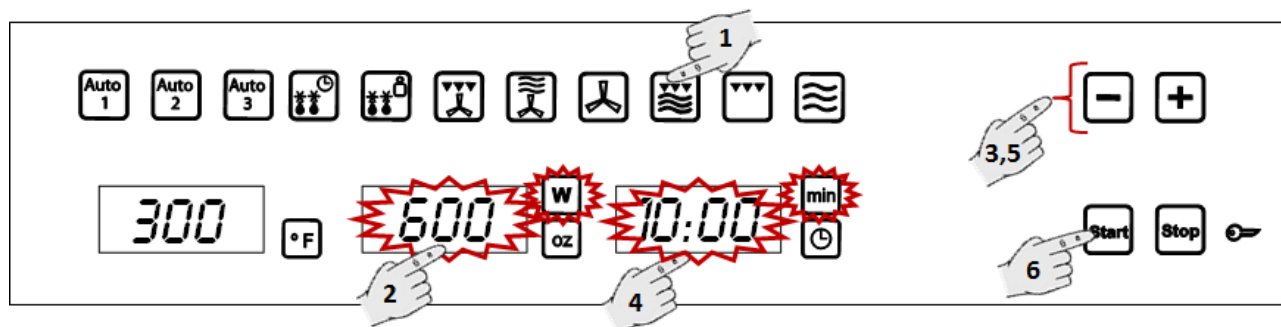

1. Press the function key **Microwave + Grill**. The function key lights up.
2. Press the **Power Selection** key to change the microwave power. The respective light will flash. If you do not press this key, the oven operates at 600 W.
3. To change the microwave power press key “-” and “+”.
4. Press the **Time Selection** key to change the operating time. The respective light will start to flash.
5. Press key “-” and “+”, to change the function time (e.g. 10 minutes).
6. Press the **Start** key. The oven will start to operate.
7. In combined mode, the microwave oven power is limited to 600 W.

Basic Functions

Hot-Air

Use this function to bake and roast.

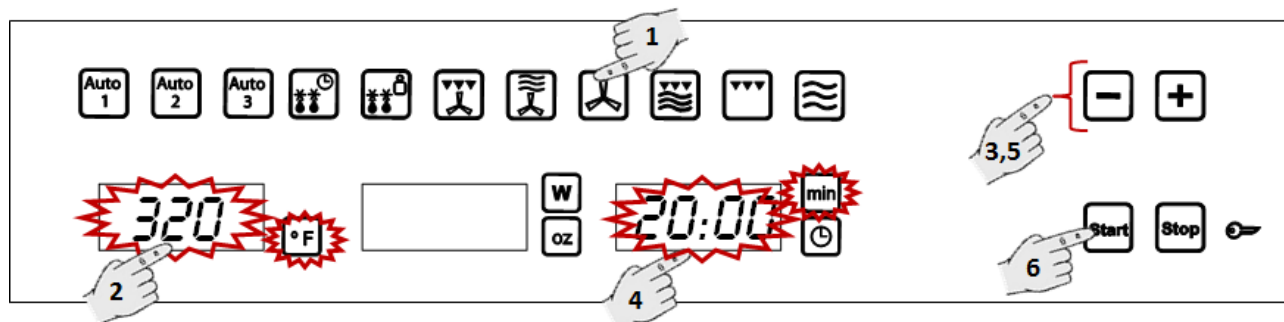

1. Press the function key Hot air. The function key lights up.
2. Press the temperature key to change the temperature. The respective light will flash. If you do not press this key, the oven operates at 320°F.
3. To change the temperature press key “-” and “+”.
4. Press the **Time Selection** key to change the operating time. The respective light will start to flash.
5. Press key “-” and “+”, to change the function time (e.g. 20 minutes).
6. Press the **Start** key. The oven will start to operate.

Microwave + Hot-Air

Use this function to rapidly bake the foods.

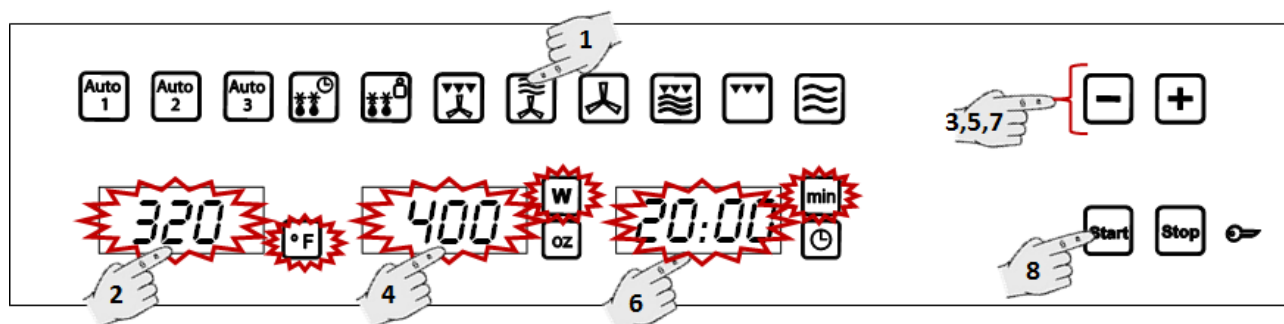

1. Press the function key **Microwave + Hot air**. The function key lights up.
2. Press the **Temperature Selection** key to change the temperature. The respective light will start to flash. If you do not press this key, the oven operates at 320°F.
3. Press key “-” and “+”, to change the temperature.
4. Press the **Power Selection** key to change the microwave power. The respective light will flash. If you do not press this key, the oven operates at 400 W.
5. To change the microwave power press key “-” and “+”.
6. Press the **Time Selection** key to change the operating time. The respective light will start to flash.
7. Press key “-” and “+”, to change the function time (e.g. 20 minutes).
8. Press the **Start** key. The oven will start to operate,
9. In combined mode, the microwave oven power is limited to 600 W.

Basic Functions

Broiler + Fan

Use this function for crispy roast meat, fish, poultry or French fries.

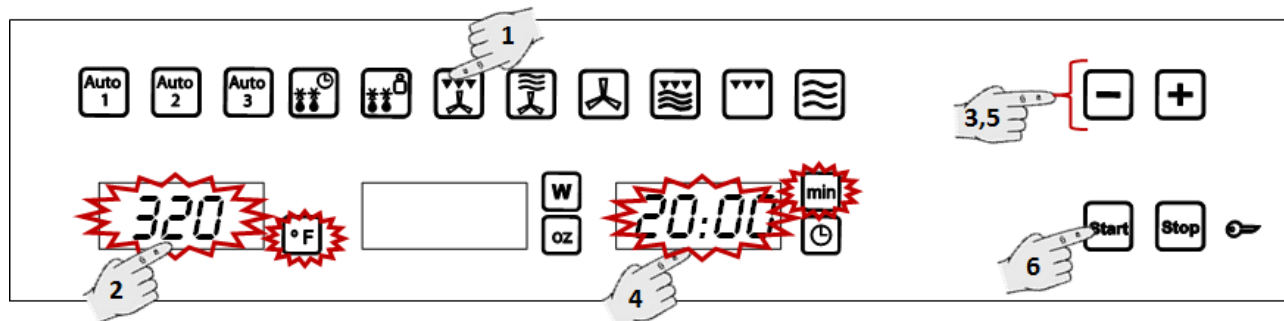

1. Press the function key **Broiler with Fan**. The function key lights up.
2. Press the **Temperature** key to change the temperature. The respective light will flash. If you do not press this key, the oven operates at 320 °F.
3. To change the temperature press key “-” and “+”.
4. Press the **Time Selection** key to change the operating time. The respective light will start to flash
5. Press key “-” and “+”, to change the function time (e.g. 20 minutes).
6. Press the **Start** key. The oven will start to operate.

Defrosting by time (manual)

Use this function to defrost any type of food quickly.

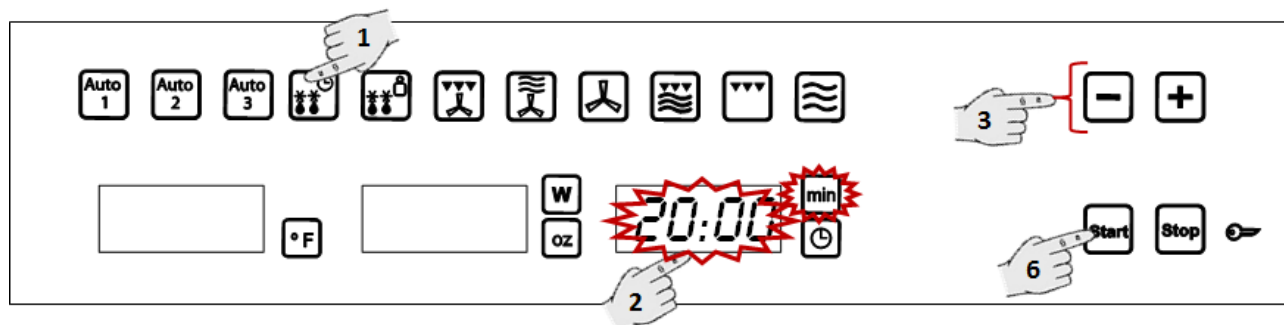

1. Press the function key **Defrosting by time**. The function key lights up.
 2. Press the **Time Selection** key to change the function time. The respective light will flash.
 3. Press key “-” and “+”, to change the function time (e.g. 10 minutes).
 4. Press the **Start** key. The oven will start to operate.
- Note:** Stir or mix the foods several times during heating, especially when the oven emits a beep and the display is flashing *turn*.

Defrosting by weight (automatic)

Use this function to defrost meat, poultry, fish, fruit and bread quickly.

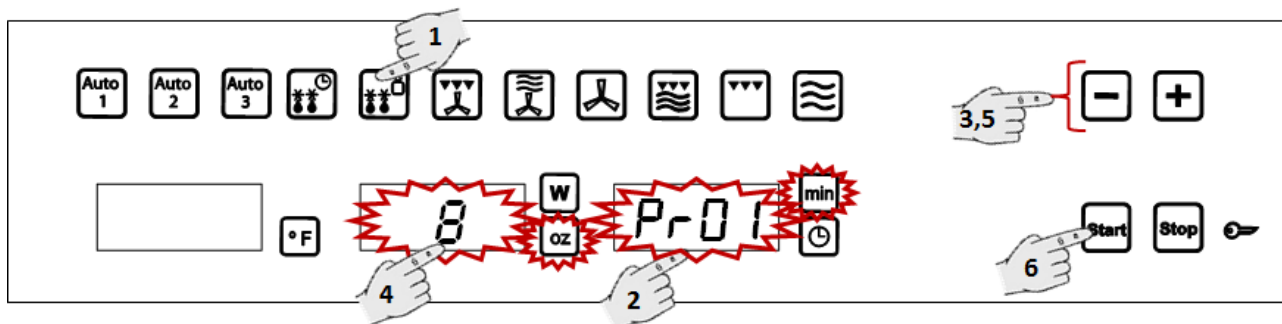

1. Press the function key **Defrosting by weight**. The function key lights up.
2. Press the **Food Type** selection key to change the food type. The respective lights will flash.
3. Press key “-” and “+”, to change the program, e.g. “Pr 01” (see following table).
4. Press the **Weight Selection** key to define the food weight. The respective light will flash.
5. Press key “-” and “+”, to change the weight.
6. Press the **Start** key. The oven will start to operate.
7. Turn the food whenever the oven lets out a beep, and the display flashes the word *turn*. Press the Start key to resume.

The following table shows the defrosting by weight function programs, indicating weight intervals, and defrosting and standing times (in order to ensure the food is of a uniform temperature).

Program	Food	Weight (OZ)	Time (min)	Standing time (min)
Pr 01	Meat	4 – 80	2,27 – 49,08	20 – 30
Pr 02	Poultry	4 – 100	2,38 – 66,09	20 – 30
Pr 03	Fish	4 – 80	2,16 – 45,21	20 – 30
Pr 04	Fruit	4 – 40	2,56 – 29,29	10 – 20
Pr 05	Bread	4 – 60	2,44 – 41,06	10 – 20

Important Note: see “General instructions for defrosting”.

Special functions

Special Function Auto 1: Heating food

Use this function to heat various types of food.

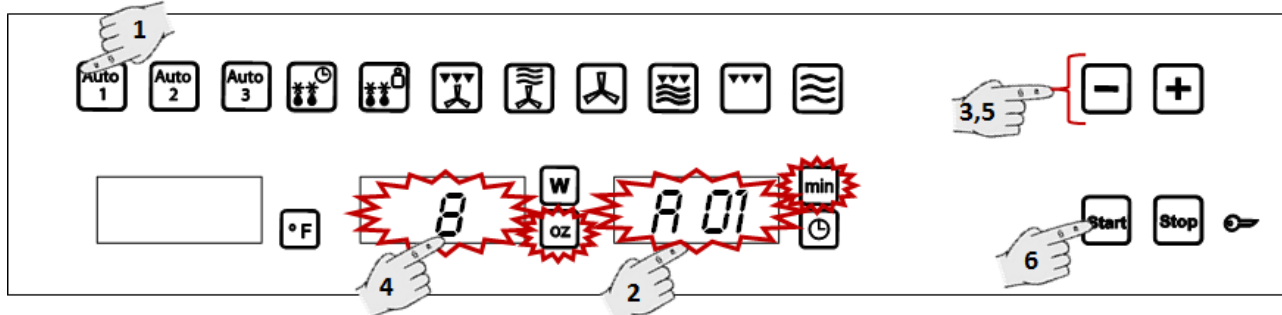

1. Press the function key **Auto 1**. The function key lights up.
2. Press the **Food Type** selection key to change the food type. The respective lights will flash.
3. Press key “-” and “+”, to change the program, e.g. “A 01” (see following table).
4. Press the **Weight Selection** key to define the food weight. The respective light will flash.
5. Press key “-” and “+”, to change the weight.
6. Press the **Start** key. The oven will start to operate.

The following table shows the Special Function **Auto 1** programmes, indicating weight intervals, and defrosting and standing times (in order to ensure the food is of a uniform temperature).

Program	Food	Weight (oz)	Time (min)	Standing time (min)
A 01	Soup	4 – 52	2,11 – 14,42	Keep covered, 1-2 min.
A 02	Pre-prepared dishes dense food	4 – 52	1,50 – 19,39	Keep covered, 1-2 min.
A 03	Pre-prepared dishes e.g. goulash	4 – 52	1,57 – 17,35	Keep covered, 1-2 min.
A 04	Vegetables	4 – 52	1,50 – 13,47	Keep covered, 1-2 min.

Important Notes:

- Always use dishes for use in the microwave oven and a lid or cover to avoid loss of liquids.
- The time required to heat the food will depend on its initial temperature. Food taken straight from the fridge will take longer to heat up than food that is at room temperature.
- After heating, stir the food or shake the container and then leave the food to stand for

some time to allow the temperature to become uniform throughout the food.

Warning! After heating the container may be very hot. Although microwaves do not heat up most containers, these may heat up through heat transmission from food.

Special functions

Special Function Auto 2: Cooking

Use this function to cook fresh food.

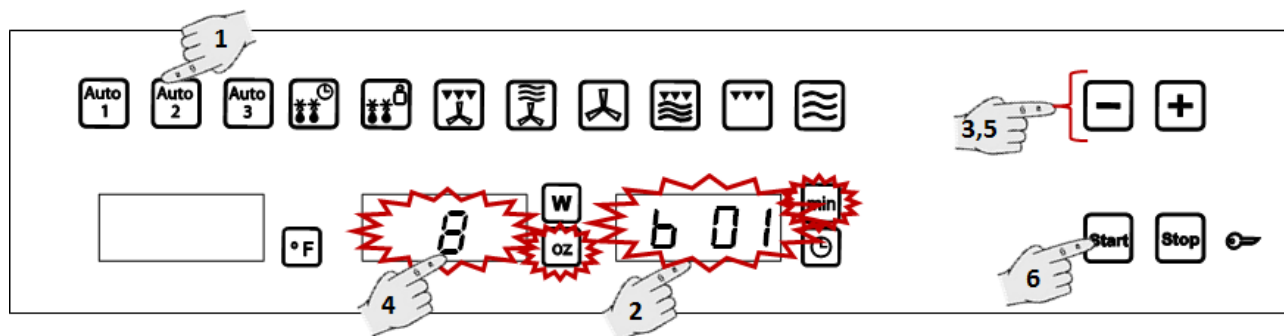

1. Press the function key **Auto 2**. The function key lights up.
2. Press the **Food Type** selection key to change the food type. The respective lights will flash.
3. Press key “-” and “+”, to change the program, e.g. “b 01” (see following table).
4. Press the **Weight Selection** key to define the food weight. The respective light will flash.
5. Press key “-” and “+”, to change the weight.
6. Press the **Start** key. The oven will start to operate.

The following table shows the Special Function **Auto 2** programmes, indicating weight intervals, and defrosting and standing times (in order to ensure the food is of a uniform temperature).

Program	Food	Weight (OZ)	Time (min)	Note
b 01	Potatoes	8 – 52	4,26 – 24,45	Keep covered
b 02	Vegetables	8 – 52	4,22 – 21,34	Keep covered
b 03	Rice	8 – 20	13,37 – 21,33	One part rice, two parts water, keep covered
b 04	Fish	8 – 36	4,18 – 13,16	Keep covered

Important Notes:

- Always use dishes for use in the microwave oven and a lid or cover to avoid loss of liquids.

Warning! After heating, the container may be very hot. Although microwaves do not heat up most containers, these may heat up through heat transmission from food.

Preparation instructions:

- Fish pieces – Add 1 to 3 soup spoons of water or lemon juice.
- Rice – Add water equivalent to twice times the quantity of rice.
- Unpeeled potatoes – Use potatoes of the same size. Wash them and prick the skin several times. Add 1 to 3 soup spoons of water.
- Peeled potatoes and Fresh vegetables– Cut into pieces of the same size. Add a soup spoon of water for every 100 g of vegetables, and salt to taste.

Special functions

Special Function Auto 3: Defrosting & Toasting

Use this function to defrost and toast various types of food.

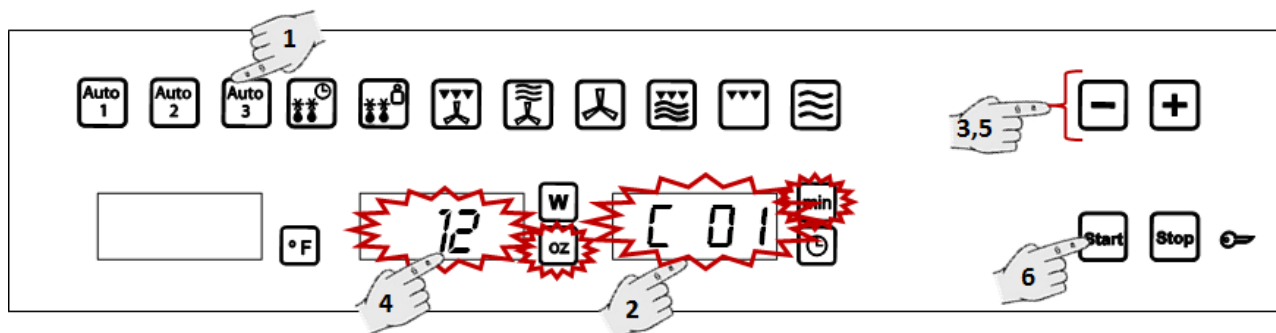

1. Press the function key **Auto 3**. The function key lights up.
2. Press the **Food Type** selection key to change the food type. The respective lights will flash.
3. Press key “-” and “+”, to change the program, e.g. “C 01” (see following table).
4. Press the **Weight Selection** key to define the food weight. The respective light will flash.
5. Press key “-” and “+”, to change the weight.
6. Press the **Start** key. The oven will start to operate.

The following table shows the Special Function **Auto 3** programmes, indicating weight intervals, and defrosting and standing times (in order to ensure the food is of a uniform temperature).

Program	Food	Weight (OZ)	Time (min)	Note
C 01	Pizza	12 – 20	8,38 – 12,16	Rack
C 02	Deep frozen food	16 – 36	8,32 – 14,12	Keep covered
C 03	Potato dishes, frozen	8 – 16	10,11 – 11,59	Glass plate

Important Notes:

- Always use dishes that are suitable for microwaving and heat resistant (e.g. baking dishes). The oven produces very high temperatures. For program C 02 always use a lid, to prevent loss of liquids.

Warning! After heating, the container may be very hot. Although microwaves do not heat most containers, they can get very hot due to heat transfer

Preparation instructions:

- Frozen pizza – Use pre-cooked frozen pizzas and pizzas-rolls.
- Deep-frozen food – Use lasagna, cannelloni, and prawn soufflé, all frozen. Keep covered.
- Potato dishes, frozen – Chips, potato croquettes and fried potatoes must be suitable for preparation in the oven.

When the oven is working...

Interrupting a cooking cycle

You can stop the cooking process at any time by pressing the **Stop** key once or by opening the oven door.

In both cases:

- Microwave emission is stopped immediately.
- The grill is de-activated but is still very hot. Danger of burning!
- The timer stops and the **display** shows the remaining amount of operating time.

If you wish, at this time you can:

1. Turn or stir the food to ensure it will be evenly cooked.
2. Change the process parameters.
3. Cancel the process by pressing the **Stop** key.

To restart the process, close the door and press the **Start** key

Altering parameters

The operating parameters (time, weight, power, etc.) can be altered when the cooking process has been interrupted by proceeding as follows:

1. To alter the time, press key “-” and “+”. The new time defined is immediately valid.
2. To alter the power, press the Power Selection key. The display and respective light start to flash. Alter the parameter by pressing the “-” and “+” keys and confirm by pressing the Power Selection key again.

Cancelling a cooking cycle

If you wish to cancel the cooking process, press the **Stop** key twice.

You will then hear a beep and the blinking dots “:” will appear on the **display**.

End of a cooking cycle

At the end of the process you will hear three beeps and the display will show the word “**End**”.

The beeps are repeated every 30 seconds until the door is opened or the **Stop** key is pressed.

Defrosting

The table below shows different defrosting and standing times (in order to ensure the food temperature is evenly distributed) for

different types and weights of food, plus recommendations.

Food	Weight (oz.)	Defrosting time (min)	Standing time (min)	Recommendation
Portions of meat, veal, beef, pork	3.5	2-3	5-10	Turn once
	7	4-5	5-10	Turn once
	18	10-12	10-15	Turn twice
	35	21-23	20-30	Turn twice
	53	32-34	20-30	Turn twice
	71	43-45	25-35	Turn three times
Goulash	18	8-10	10-15	Turn twice
	35	17-19	20-30	Turn three times
Ground meat	3.5	2-4	10-15	Turn twice
	18	10-14	20-30	Turn three times
Sausages	7	4-6	10-15	Turn once
	18	9-12	15-20	Turn twice
Poultry (portions)	9	5-6	5-10	Turn once
Chicken	35	20-24	20-30	Turn twice
Poularde	88	38-42	25-35	Turn three times
Fish fillet	7	4-5	5-10	Turn once
Trout	9	5-6	5-10	Turn once
Prawns	3.5	2-3	5-10	Turn once
	18	8-11	15-20	Turn twice
Fruit	7	4-5	5-10	Turn once
	11	8-9	5-10	Turn once
	18	11-14	10-20	Turn twice
Bread	7	4-5	5-10	Turn once
	18	10-12	10-15	Turn once
	28	15-17	10-20	Turn twice
Butter	9	8-10	10-15	
Cream cheese	9	6-8	10-15	
Creams	9	7-8	10-15	

General instructions for defrosting

1. When defrosting, use only dishes that are appropriate for microwaves (china, glass, suitable plastic).
2. The defrost function by weight and the tables refer to the defrosting of raw food.
3. The defrosting time depends on the quantity and thickness of the food. When freezing food keep the defrosting process in mind. Distribute the food evenly in the container.
4. Distribute the food as best as possible inside the oven. The thickest parts of fish or chicken drumsticks should be turned towards the outside. You can protect the most delicate parts of food with pieces of aluminum foil. **Important:** The aluminum foil must not come into contact with the oven cavity interior as this can cause electrical arcing.
5. Thick portions of food should be turned several times.
6. Distribute the frozen food as evenly as possible since narrow and thin portions defrost more quickly than the thicker and broader parts.
7. Fat-rich foods such as butter, cream cheese and cream should not be completely defrosted. If they are kept at room temperature they will be ready to be served in a few minutes. With ultra-frozen cream, if you find small pieces of ice in it, you should mix these in before serving.
8. Place poultry on an upturned plate so that the meat juices can run off more easily.
9. Bread should be wrapped in a napkin so that it does not become too dry.
10. Turn the food at regular intervals and when the oven displays **turn**.
11. Remove frozen food from its wrapping and do not forget to take off any metal twist-tags. For containers that are used to keep frozen food in the freezer and which can also be used for heating and cooking, all you need to do is take off the lid. For all other cases you should put the food into containers that are suitable for microwave use.
12. The liquid resulting from defrosting, principally that from poultry should be discarded. In no event should such liquids be allowed to come into contact with other foods.
13. Do not forget that by using the defrosting function you need to allow for standing time until the food is completely defrosted.

Cooking with a Microwave oven

Warning! Read the section “Microwave Safety” before cooking with your microwave.

Follow these recommendations when cooking with your microwave:

- Before heating or cooking foods with peel or **skin** (e.g. apples, tomatoes, potatoes, sausages) **prick them** so that they do not burst. Cut the food up before starting to prepare it.
- Before using a container or dish make sure that it is suitable for microwave use (see the section on types of ovenware).
- When cooking food with very little moisture (e.g. **defrosting bread**, making popcorn, etc.) evaporation is very quick. The oven then works as if it was empty and the food may burn. The oven and the container may be damaged in such a situation. You should therefore set just the cooking time necessary and you must keep a close eye on the cooking process.
- It is not possible to heat large quantities of oil (**frying**) in the microwave.
- Remove **pre-cooked food** from the containers they come in since these are not always heat resistant. Follow the food manufacturer’s instructions.
- **If you have several containers**, such as cups, for example, set them out uniformly on the turntable plate.
- Do not close **plastic bags** with metal clips. Use plastic clips instead. Prick the bags several times so that the steam can escape easily.
- When heating or cooking foods, check that they reach **at least a temperature of 158°F**.
- During cooking, **steam** may form on the oven door window and may start to drip. This situation is normal and may be more noticeable if the room temperature is low. The oven’s safe working is not affected by this. After you have finished cooking, clean up the water coming from the condensation

- When heating liquids, use **containers with a wide opening**, so that the steam can evaporate easily.

Prepare the foods as per the instructions and keep in mind the cooking times and power levels indicated in the tables.

Keep in mind that the figures given are only indicative and can vary depending on the initial state, temperature, moisture and type of food. It is advisable to adjust the times and power levels to each situation. Depending on the exact characteristics of the food you may need to increase or shorten the cooking times or increase or decrease the power levels.

Cooking with microwaves rules

1. The greater the amount of food, the longer the cooking time. Keep in mind that:
 - Double the quantity » double the time
 - Half the quantity » half the time
2. The lower the temperature, the longer the cooking time.
3. Foods containing a lot of liquid heat up more quickly.
4. Cooking will be more uniform if the food is evenly distributed on the turntable. If you put dense foods on the outside part of the plate and less dense ones on the center of the plate, you can heat up different types of food simultaneously.
5. You can open the oven door at any time. When you do this the oven switches off automatically. The microwave will only start working again when you close the door and press the start key.
6. Foods that are covered require less cooking time and retain their characteristics better. The lids used must let microwaves pass through and have small holes that allow steam to escape.

Cooking with a microwave oven

Tables and suggestions – Cooking vegetables

Food	Quantity (oz.)	Addition of liquids (tablespoons)	Power (Watt)	Time (min.)	Standing Time (min.)	Instructions
Cauliflower	17-18	7	800	9-11	2-3	Cut into slices.
Broccoli	10-11	4	800	6-8	2-3	Keep covered
Mushrooms	8-9	2	800	6-8	2-3	Turn once
Peas & carrots	10-11	7	800	7-9	2-3	Cut into chunks or slices. Keep covered
Frozen carrots	8-9	2	800	8-10	2-3	Turn once
Potatoes	8-9	2	800	5-7	2-3	Peel and cut into equal sized pieces. Keep covered Turn once
Paprika	8-9	2	800	5-7	2-3	Cut into chunks or slices Keep covered
Leek	8-9	4	800	5-7	2-3	Turn once
Frozen Brussels sprouts	10-11	4	800	6-8	2-3	Keep covered Turn once
Sauerkraut	8-9	2	800	8-10	2-3	Keep covered Turn once

Tables and suggestions – Cooking fish

Food	Quantity (oz.)	Power (Watt)	Time (min.)	Standing Time (min.)	Instructions
Fish fillets	17-18	600	10-12	3	Cook covered over. Turn after half of cooking time.
Whole fish	28-29	800 400	2-3 7-9	2-3	Cook covered over. Turn after half of cooking time. You may wish to cover up the small edges of the fish.

Cooking with the Broiler

For good results with the Broiler, use the grid iron supplied with the oven.

Fit the grid iron in such a way that it doesn't come into contact with the metal surfaces of the oven cavity since if it does there is a danger of electric arcing which may damage the oven.

IMPORTANT POINTS:

1. When the microwave Broiler is used for the first time there will be some smoke and a smell coming from the oils used during oven manufacture.
2. The oven door window becomes very hot when the Broiler is working. **Keep children away.**
3. When the Broiler is operating, the cavity walls and the grid iron become very hot. You should use oven gloves.

4. If the Broiler is used for extended period of time it is normal to find that the elements will switch themselves off temporarily due to the safety thermostat.
5. **Important!** When food is to be broiled or cooked in containers you must check that the container in question is suitable for microwave use. See the section on types of ovenware!
6. When the Broiler is used it is possible that some splashes of fat may go onto the elements and be burnt. This is a normal situation and does not mean there is any kind of operating fault.
7. After you have finished cooking, clean the interior and the accessories so that cooking remains do not become encrusted.

Tables and suggestions – Broiler without microwave

Type	Quantity (oz)	Time (min.)	Instructions
Fish			
Bass	28	18-24	Spread lightly with butter. After half of cooking time turn and spread with seasoning.
Sardines/gurnard	6-8 fish.	15-20	
Meat			
Sausages	6-8 units	22-26	Halfway through, pierce and turn over.
Frozen hamburgers	3 units	18-20	Turn over 2 or 3x
Spare rib (approx. 1" thick)	14	25-30	Baste with oil, turn over halfway through
Others			
Toast	4 units	1½-3	Keep an eye on the toasting process, turn over
Toasted sandwiches	2 units	5-10	Keep an eye on the toasting process.

Heat up the Broiler beforehand for 2 minutes. Unless indicated otherwise, use the rectangular rack. Place the rack on the rectangular glass tray so that the water and the fat can drip off.

The times shown are merely indicative and can vary as a function of the composition and quantity of the food, as well as the final condition wished for. Fish and meat taste great if, before broiling, you brush them with vegetable oil, spices and herbs and leave to

marinate for a few hours. Only add salt after broiling.

Sausages will not burst if you prick them with a fork before broiling.

After half the broiling time has passed, check on how the cooking is going and, if necessary, turn the food over.

The Broiler is especially suitable for cooking thin portions of meat and fish. Thin portions of meat only need to be turned once, but thicker portions should be turned several times.

Cooking with the Broiler

Tables and suggestions – Microwave + Broiler

The microwave + Broiler function is ideal for cooking quickly and, at the same time, browning foods. Furthermore, you can also broil and cook cheese covered food.

The microwave and the Broiler work simultaneously. The microwave cooks and the Broiler toasts.

Food	Quantity (oz.)	Dish	Power (Watt)	Time (min.)	Standing time (min.)
Cheese topped pasta	17	Low dish	400	12-17	3-5
Cheese topped potatoes	28	Low dish	600	20-22	3-5
Lasagna	approx. 28	Low dish	600	15-20	3-5
2 fresh chicken legs (grilled)	7 each	Low dish	400	10-15	3-5
Chicken	approx. 35	Low and wide dish	400	35-40	3-5
Cheese topped onion soup	2 x 7 oz. cups	Soup bowls	400	2-4	3-5

Before using a dish in the microwave oven make sure that it is suitable for microwave use. Only use dishes or containers that are suitable for microwave use.

The dish to be used in the combined function must be suitable for microwave and Broiler use. See the section on types of ovenware!

Keep in mind that the figures given are merely indicative and can vary as a function of the initial state, temperature, moisture and type of food.

If the time is not enough to brown the food well, put it under the Broiler for another 5 or 10 minutes.

Please follow the standing times and don't forget to turn the meat pieces.

Unless indicated to the contrary, use the turntable plate for cooking.

The values given in the tables are valid when the oven cavity is cold (it is not necessary to pre-heat the oven).

Roasting and baking

Table and advice – Preparing meat and cake

Microwave / Convection

Food	Quantity (oz.)	Power (W)	Temperature	Time (Min.)	Standing time (min.)	Instructions
Roast beef	35-53	400	392°F	30-40	20	Do not put lid on container Turn once
Pork loin / Cutlet or bones Pork roast	28-36	200	356°F-374°F	50-60	20	Do not put lid on container Turn once
Whole chicken	35-43	400	392°F	30-40	10	Do not put lid on container. Turn the chicken chest down. Turn once.
Half chicken	17-35	400	392°F	25-35	10	Do not put lid on container. Turn the pieces with skin down. Turn once.
Roast loin of veal	53-71	200	356°F	60-65	20	Do not put lid on container. Turn once or twice. After turning keep it without lid
Roast Beef	53-64	200	392°F	80-90	20	Do not put lid on container. Turn once or twice

Microwave / Baking

Pastry	Power (W)	Temperature	Time (Min.)	Standing time (min.)	Instructions
Chocolate– cherry pie	200	392°F	30	5-10	Turntable, small Broiler, Springform, Ø 11"
Cheesecake with fruit	400	356°F	40-45	5-10	Turntable, small Broiler, Springform, Ø 11"
Apple pie	200	365°F	40-45	5-10	Turntable, small Broiler, Springform, Ø 11"
Cheese cake with streusel	400	356°F	40-50	5-10	Turntable, small Broiler, Springform, Ø 10"
Nuts cake	200	338°F	30-35	5-10	Turntable, Cake tin

Advice to roast - bake

Turn the pieces of meat halfway through the cooking time. When the roasted meat is ready you should let it stand for 20 minutes in the oven with this switched off and closed. This will ensure the juices in the meat are well distributed.

The roasting temperature and time required depends on the type and amount of meat being cooked.

If the weight of the meat to be roasted does not appear on the table choose the settings for the weight immediately below and extend the cooking times.

Advice on ovenware

Check that the ovenware fits inside the oven.

Hot glass containers should be put on a dry kitchen cloth. If such containers are put on a cold or wet surface the glass may crack and break. Use oven gloves to take the ovenware out of the oven.

Baking

Table and advice – Baking/ Convection

Type	Container	Level	Temperature	Time (min.)
Walnut cake	Spring-form type tin	Turntable	320 °F	30/35
Fruit tart	Spring-form type tin Ø 11"	Turntable, small round grille	320 °F	35/45
Ring cake	Spring-form type tin	Turntable	320°F	30/45
Spicy cakes and breads	Spring-form type tin	Turntable, small round grille	374°F–392°F	50/70
Sponge cake	Spring-form type tin Ø 10"	Turntable, small round grille	320°F	40/45
Jelly roll	Glass griddle	1	392°F	35/45
Cherry pie	Glass griddle	1	356°F-374°F	35/45

Advice on cake baking ware

The most commonly used type of baking ware is black metal tins. If you are also going to use the microwave, use glass, ceramic or plastic baking ware. These must be able to withstand temperatures up to 482°F. If you use these types of baking ware the cakes are not browned as much.

Advice on how to bake cakes

Different amounts and types of pastry require different temperatures and baking times. Try low settings first of all and then, if necessary, use higher temperatures next time. A lower temperature will result in more uniform baking. Always put the cake tray in the center of the turntable.

Baking suggestions

How to check if the cake is properly cooked

Start sticking a tooth pick in the highest part of the cake 10 minutes before the end of the baking time. When no dough sticks to the tooth pick the cake is ready.

If the cake is very dark on the outside:

Next time choose a lower temperature and let the cake bake for a longer time.

If the cake is very dry

Make small holes in the cake with a tooth pick after baking has finished. Then sprinkle the cake with some fruit juice or alcoholic drink. Next time increase the temperature by about 50°F and reduce the baking time.

If the cake does not come free when turned

Let the cake cool down for 5 to 10 minutes after baking and it will come out of the tin more easily. If the cake still does not come free run a knife carefully around the edges. Next time grease the cake tin well.

Advice on saving energy

When you are making more than one cake, it is advisable to bake them in the oven one after the other when the oven is still hot. This lets you reduce the baking time for the second and later cakes.

It is preferable to use dark colored baking ware - painted or enameled black – since such baking tins absorb heat better.

When dealing with long baking times, you can switch the oven off 10 minutes before the end of the time and make use of the residual heat to complete the baking.

What kind of ovenware can be used?

Microwave function

For the microwave function, keep in mind that microwaves are reflected by metal surfaces. Glass, china, clay, plastic, and paper let microwaves pass.

For this reason, **metal pans and dishes or containers with metal parts or decorations cannot be used in the microwave**. Glass ware and clay with **metallic decoration or content** (e.g. lead crystal) cannot be used in microwave ovens.

The **ideal** materials for use in microwave ovens are glass, refractory china or clay, or heat resistant plastic. Very thin, fragile glass or china should only be used for short period of times (e.g. heating).

Hot food transmits heat to the dishes which can become very hot. You should, therefore, always use an **oven glove!**

How to test ovenware you want to use

Put the item you want to use in the oven for 20 seconds at maximum microwave power. After that time, if it is cold and just slightly warm, it is suitable to use. However, if it heats up a lot or causes electric arcing it is not suitable for microwave use.

Broiler and Convection function

In the case of the Broiler function, the ovenware must be resistant to temperature of at least 572°F. Plastic dishes are not suitable for use in the Broiler.

Combined functions

In the combined function, the ovenware must be suitable for use in conventional heating functions (microwave and grill).

Aluminum containers and foil

Pre-cooked food in aluminum containers or in aluminum foil can be put in the microwave if the following aspects are respected:

- Keep in mind the manufacturer's recommendations written on the packaging.
- The aluminum containers cannot be more than 3 cm high or come in contact with the cavity walls (**minimum distance 3 cm**). Any aluminum lid or top must be removed.
- Put the aluminum container directly on top of the turntable plate. If you use the grid iron, put the container on a china plate. Never put the container directly on the grid iron!
- The cooking time is longer because the microwaves only enter the food from the top. If you have any doubts, it is best to use only dishes suitable for microwave use.
- Aluminum foil can be used to reflect microwaves during the defrosting process. Delicate food, such as poultry or minced meat, can be protected from excessive heat by covering the respective extremities/edges.
- **Important:** aluminum foil cannot come into contact with the cavity walls since this may cause electrical arcing.

Lids

We recommend you use glass or plastic lids since:

1. This will stop excessive evaporation (mainly during very long cooking times);
2. The cooking times are shorter;
3. The food does not become dry;
4. The aroma is preserved.

The lid should have holes or openings so that no pressure develops. Plastic bags must also be opened. Baby feeding bottles or jars with baby food and similar containers can only be heated without their tops / lids otherwise they can burst.

What kind of ovenware can be used?

Table of Ovenware

The table below gives you a general idea of what type of ovenware is suitable for each situation.

Type of ovenware	Operating mode	Microwave		Broiler / Convection	Combined functions
		Defrosting / heating	Cooking		
Glass and china 1) Home use, not flame resistant, can be used in dish washer		yes	yes	no	no
Glazed china Flame resistant glass and china		yes	yes	yes	yes
China, stone ware 2) Unglazed or glazed without metallic decorations		yes	yes	no	no
Clay dishes 2) Glazed		yes	yes	no	no
Unglazed		no	no	no	no
Plastic dishes 2) Heat resistant to 212°F		yes	no	no	no
Heat resistant to 482°F		yes	yes	no	no
Plastic films 3) Plastic film for food		no	no	no	no
Cellophane		yes	yes	no	no
Paper, cardboard, parchment 4)		yes	no	no	no
Metal Aluminum foil		yes	no	yes	no
Aluminum wrappings 5)		no	yes	yes	yes
Accessories		yes	yes	yes	yes

1. Without any gold or silver leaf edging; no lead crystal.
2. Keep the manufacturer's instructions in mind!
3. Do not use metal clips for closing bags. Make holes in the bags. Use the films only to cover the food.

4. Do not use paper plates.
5. Only shallow aluminum containers without lids/tops. The aluminum cannot come into contact with the cavity walls.

Cleaning is the only maintenance normally required.

Warning! Your microwave oven should be cleaned regularly, with all food remains being removed. If the microwave is not kept clean its surfaces may deteriorate, **reducing the oven's working life and possibly resulting in a dangerous situation.**

Warning! Cleaning should be done with the oven power switched off. Take the plug out of the socket or switch off the oven's power circuit.

Do not use aggressive or abrasive cleaning products, scourers that scratch surfaces or sharp objects, since stains may appear.

Do not use high pressure or steam jet cleaning appliances.

The door contact surfaces (the front of the cavity and the inside part of the doors) must be kept very clean in order to ensure the oven functions correctly.

Do not use harsh abrasive cleaners or sharp metal scrapers to clean the oven door glass since they can scratch the surface, which may result in shattering of the glass.

Front surface

Normally you just need to clean the oven with a damp cloth. If it is very dirty, add a few drops of dishwashing liquid to the cleaning water. Afterwards, wipe the oven with a dry cloth.

Immediately remove lime, fat, starch or egg white stains. Corrosion can occur under these stains.

Do not let any water get inside the oven.

Oven interior

After each time the oven is used, clean the inside walls with a damp cloth since this is the easiest way to remove splashes or spots of food that may have stuck to the inside.

To remove dirt that is harder to shift, use a non-aggressive cleaning product. **Do not use oven sprays or other aggressive or abrasive cleaning products.**

Always keep the door and the oven front very clean to ensure that the door opens and closes properly.

Make sure water does not enter the microwave ventilation holes.

Regularly take out the turntable plate and the respective support and clean the cavity base, especially after any liquid spillage.

Do not switch on the oven without the turntable and the respective support being in place.

If the oven cavity is very dirty, put a glass of water on the turntable and switch on the microwave oven for 2 or 3 minutes at maximum power. The steam released will soften the dirt which can then be cleaned easily using a soft cloth.

Unpleasant odors (e.g. after cooking fish) can be eliminated easily. Put a few drops of lemon juice in a cup with water. Put a spoonful of coffee in the cup to avoid the water boiling over. Heat the water for 2 to 3 minutes at maximum microwave power.

Oven Cleaning and Maintenance

Oven ceiling

If the oven ceiling is dirty, the Broiler can be lowered to make cleaning easier.

To avoid the danger of burning, wait until the Broiler is cold before lowering it. Proceed as follows:

1. Turn the Broiler support by 90° (1).
2. Lower the Broiler gently (2). **Do not use excessive force as this may cause damage.**
3. After cleaning the ceiling, put the Broiler (2) back in its place, carrying out the previous operation.

IMPORTANT WARNING: The Broiler heating element support (1) may fall when it is rotated. If this happens, insert the Broiler heating element support (1) into the slot in the ceiling of the cavity and rotate it 90° to the Broiler heating element support (2) position.

The mica cover (3) located in the ceiling must always be kept clean. Any food remains that collect on the mica cover can cause damage or provoke sparks.

Do not use abrasive cleaning products or sharp objects.

To avoid any risk, do not remove the mica cover.

The glass lamp cover (4) is located on the oven ceiling and can be removed easily for cleaning. For this you just need to unscrew it and clean it with water and dishwashing liquid.

Accessories

Clean the accessories after each use. If they are very dirty, soak them first of all and then use a brush and sponge. The accessories can be washed in a dish washing machine.

Make sure that the turntable plate and the respective support are always clean. Do not switch on the oven unless the turntable and the respective support are in place.

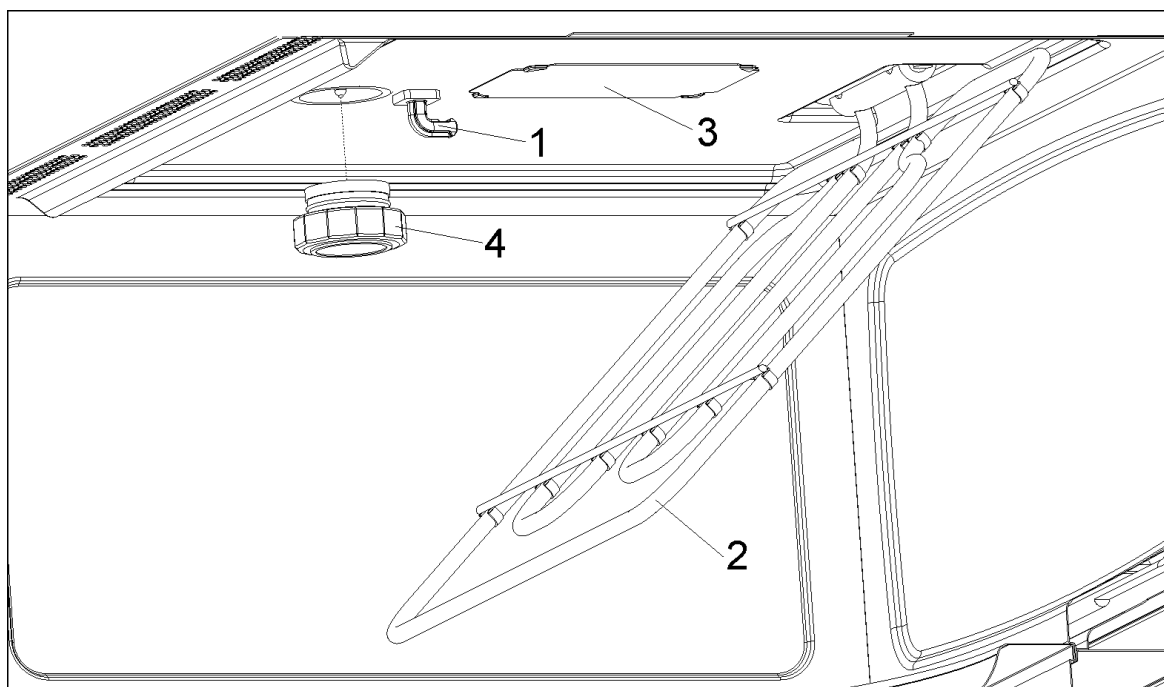

What should I do if the oven doesn't work?

WARNING! Any type of repair must only be done by a specialized technician. Any repair done by a person not authorized by the manufacturer is dangerous.

You do not need to contact Technical Assistance to resolve the following questions:

- The display is not showing! Check if:
 - The time indication has been switched off (see section on Basic Settings).
- Nothing happens when I press the keys! Check if:
 - The Safety Block is active (see section on Basic Settings).
- The oven does not work! Check if:
 - The plug is correctly fitted in the socket.
 - The oven's power is switched on.
 - The door is completely closed. The door should close with an audible click.
 - There are any foreign bodies between the door and the cavity front.
- When the oven is operating I can hear some strange noises! Check if:
 - There is any electrical arcing inside the oven caused by foreign metallic objects (see section on type of ovenware).
 - The ovenware is touching the oven walls.
 - There are any loose items of cutlery or cooking tools inside the oven.
- The food doesn't heat up or heats very slowly! Check if:
 - You have inadvertently used metal ovenware.
 - You have selected the correct operating times and power level.
 - The food you have put inside the oven is a larger amount or colder than you usually put in.
- **The food is too hot, dried out or burnt!** Check if you selected the correct operating time and power level.

- **I hear some noises after the cooking process is finished!** This is not a problem. The cooling fan keeps on working for some time. When the temperature has dropped sufficiently, the fan will switch itself off.
- **TV/radio interference might be noticed while using the microwave, similar to the interference caused by other small appliances.** This is not a problem with the Microwave. Move the radio or TV as far away from the microwave as possible, or check the position of the TV/radio antenna.
- **The oven switches on but the interior light does not go on!** If all the functions work properly it is probable that the lamp has blown. You can keep on using the oven

Substitution of light bulb

To substitute the light bulb, proceed as follows:

- Disconnect the oven from the power supply. Take the plug out of the socket or switch off the oven's power circuit.
- Unscrew and remove the glass light cover **(1)**.
- Remove the halogen light bulb **(2)**. **Warning! The bulb may be very hot.**
- Fit a new **G4/12V/10-20W** halogen bulb. **Warning! Do not touch the light bulb surface directly with your fingers because you may damage the bulb.** Follow the lamp manufacturer's instructions.
- Screw the glass light cover into place **(1)**.
- Connect the oven again to the power supply.

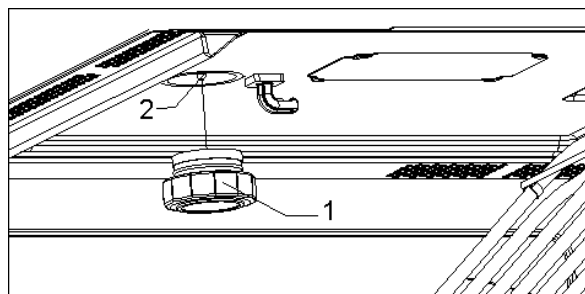

Technical characteristics

Specifications

- AC Voltage..... (see characteristics plate)
- Power required..... 3400 W
- Broiler power..... 1500 W
- Convection power 1600W
- Microwave output power. 1000 W
- Microwave frequency..... 2450 MHz
- Exterior dimensions (W×H×D)..... 23½" × 18" × 21½" in approx.
- Interior dimensions (W×H×D)..... 16½" × 8¼" × 15½" in approx.
- Oven capacity. 1,34 ft³
- Weight..... 77 lbs

Installation instructions

Before installation

Check that the input voltage indicated on the rating plate is the same as the voltage of the power outlet you are going to use.

If required by the National Electrical Code (or Canadian Electrical Code), this appliance must be installed on a separate branch circuit.

Installer – show the owner the location of the circuit breaker or fuse. Mark it for easy reference.

Before installing, turn power OFF at the service panel. Lock service panel to prevent power from being turned ON accidentally.

Be sure your appliance is properly installed and grounded by a qualified technician. Installation, electrical connections and grounding must comply with all applicable codes.

Open the oven door and **take out all the accessories** and remove the packing material.

Do not remove the mica cover on the ceiling of the interior! This cover stops fat and pieces of food damaging the microwave generator.

Warning! The front surface of the oven may be wrapped with a **protective film**. Before using the oven for the first time, carefully remove this film, starting on the inside.

Make sure that the oven is not damaged in any way. Check that the oven door closes correctly and that the interior of the door and the front of the oven opening are not damaged. If you find any damage contact the Technical Assistance Service.

DO NOT USE THE OVEN if the metal conduit is damaged, if the oven does not function correctly or if it has been damaged or dropped. Contact the Technical Assistance Service.

Place the oven on a flat and stable surface. The oven must not be put close to any sources of heat, radios or televisions.

Electrical supply

Before installing the oven have a qualified electrician verify that your home is provided with adequate electrical service and that the addition of the oven will not overload the branch circuit on which it is to be installed.

A separate three-wire or four-wire single phase, 240 Volt, 60 Hz, branch circuit is required for the oven.

For hook-up of the oven you will need to have an approved junction box installed where it will be easily reached through the front of the cabinet where the oven will be located. The oven has 3 feet of conduit.

Allow two to three feet of slack in the line so that the oven can be moved if servicing is ever necessary.

DO NOT shorten the flexible conduit.

Wiring requirements

When making the wire connections, use the entire length of the conduit provided (3 feet). The conduit must not be cut.

Before making connections make sure the power is off and read and observe the following:

1. A separate three-wire or four-wire, single phase, 240 Volt, 60 Hz branch circuit is required for the oven.
2. The oven must be connected with Copper or Aluminum wire.
3. In the United States:

Wiring must conform to the National Electrical Code, ANSI/NFPA No. 7 latest edition. You can obtain a copy of the National Electrical Code by writing to: National Fire Protection Association Batterymarch Park Quincy, MA 02269.

Installation instructions

In Canada:

Wiring must conform to Canadian Electrical Code C22.1- latest edition. You can obtain a copy of the Canadian Electrical Code by writing to: Canadian Standards Association 178 Rexdale Boulevard Rexdale (Toronto), Ontario, Canada M9W 1R3

4. Wire size (Copper or Aluminum wire) and connections must be suitable for the rating of the appliance as per the National Electrical Code requirements. The flexible armoured cable extending from the oven should be connected directly to the junction box.
5. The junction box should be located so as to allow as much slack as possible between the junction box and the oven so it can be moved if servicing is ever required.
6. A U.L. listed conduit connector must be provided at each end of the power supply cable.

Electrical connections

Be sure your appliance is properly installed and grounded by a qualified technician. Ask your dealer to recommend a qualified technician or an authorized repair service.

This appliance is manufactured with a green GROUND wire connected to the oven chassis. After making sure that the power has been turned off, connect the flexible conduit from the oven to the junction box using a U.L. listed conduit connector. The figures and the instructions provided below present the most common way of connecting the ovens.

Your local codes and ordinances, of course, take precedence over these instructions.

WARNING” Risk of Electric Shock, frame grounded to neutral of appliance through a link.

Grounding through the neutral conductor is prohibited for new branch-circuit installations (1996 NEC); mobile homes; and recreational vehicles, or in an area where local codes prohibit grounding through the neutral

conductor. For installations where grounding through the neutral conductor is prohibited:

- Disconnect the ground from the neutral at free end of conduit;
- Use grounding terminal or lead to ground unit; and
- Connect neutral terminal or lead to branch circuit neutral in usual manner.

3-Wire branch circuit (for US only)

Refer to the following Figure, where local codes allow the connection of GROUND wire from the oven to the branch circuit NEUTRAL wire (gray or white colored wire):

- If local codes permit, connect the green GROUND wire from the oven and the white wire from the oven to the branch circuit NEUTRAL wire (gray or white colored wire).
- Connect the red and black leads from the oven to the corresponding leads in the junction box.

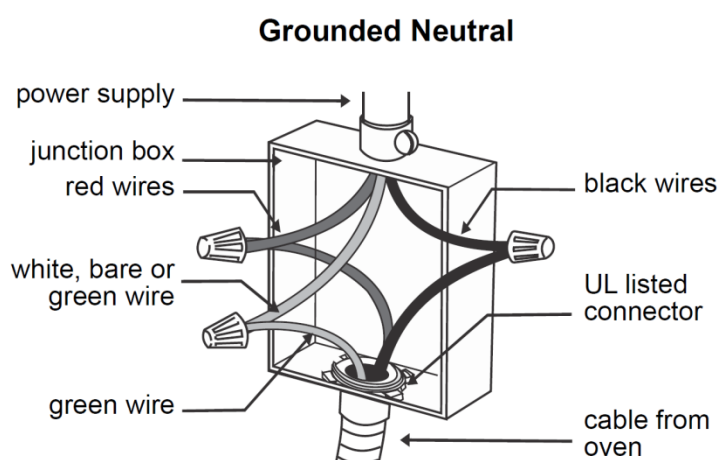

Installation instructions

4-Wire branch circuit (for US and CANADA)

Refer to the following Figure:

- Disconnect ground from neutral at free end of conduit.
- Connect the green GROUND wire from the oven to the GROUND wire in the junction box (bare or green colored wire).
- Connect the red and black leads from the oven to the corresponding leads in the junction box.

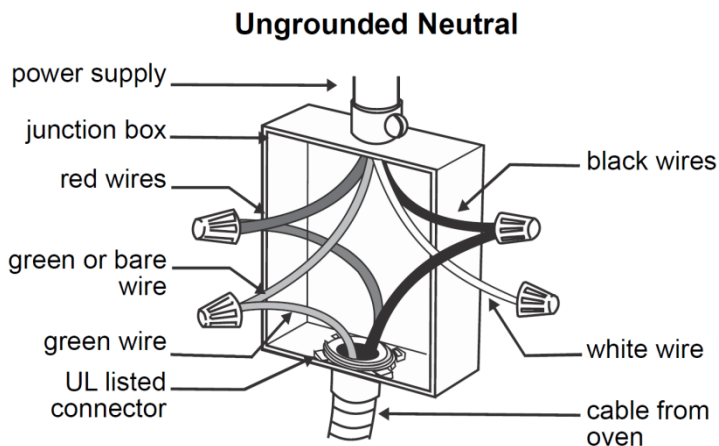

After installation

The oven only functions when the door is closed correctly.

After the first use, clean the inside of the oven and the accessories, following the cleaning instructions given in the section "Oven cleaning and maintenance".

Fit the Turntable support in the center of the oven cavity and put the Turntable ring and the Turntable plate on top, making sure they slot in. Whenever you use the microwave, the turntable plate and the respective accessories must be inside and correctly fitted. The turntable plate can rotate in both directions.

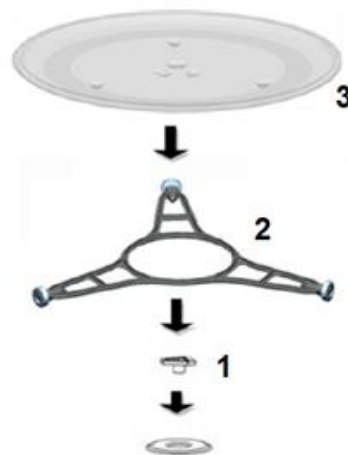

Installation dimensions

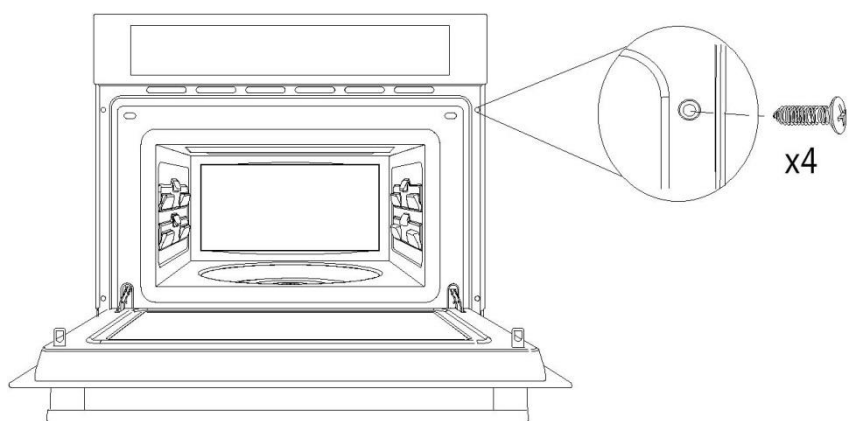
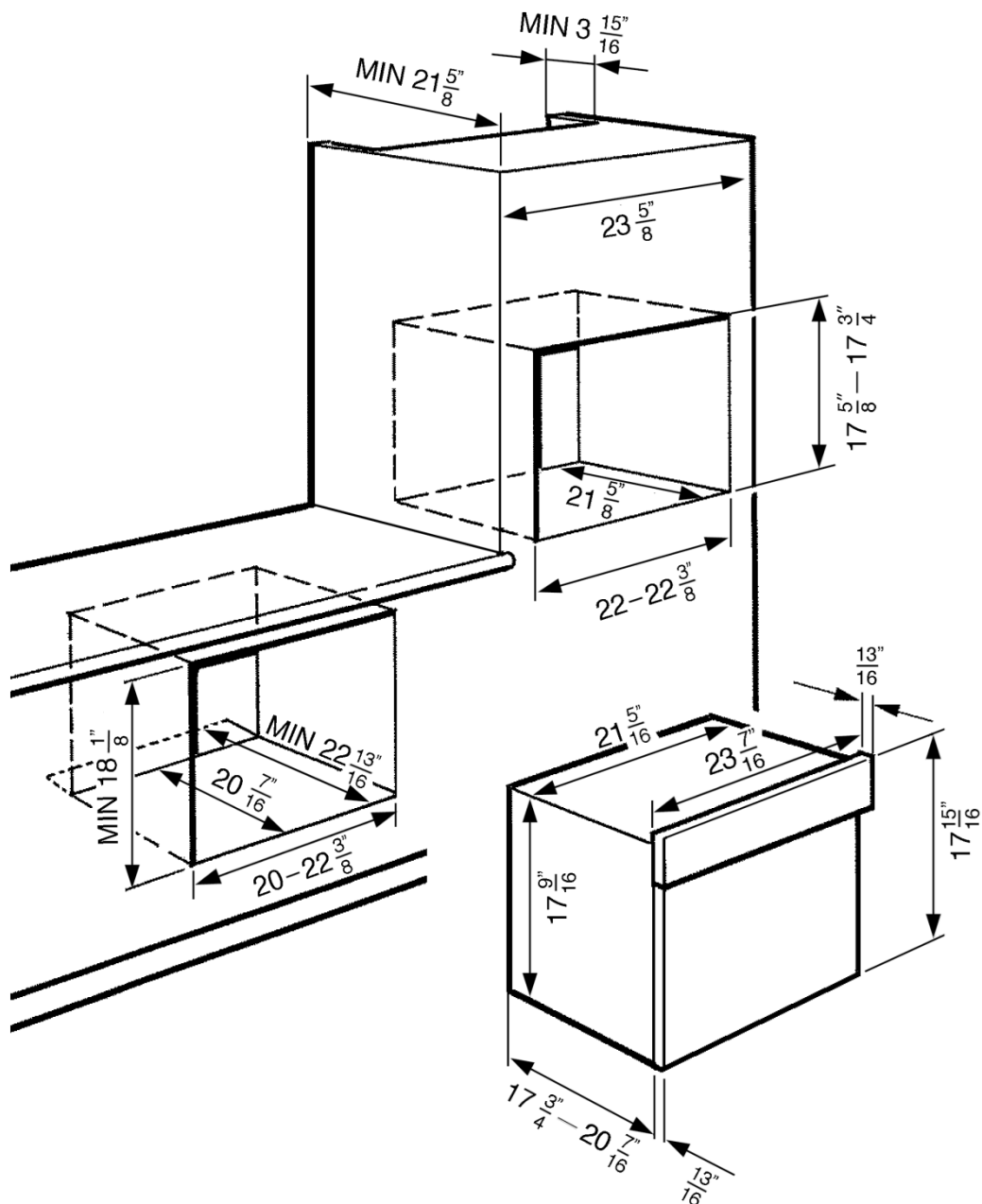

EN

- Push oven completely into the cabinet and center it.
- Open microwave door and fasten the appliance to the cabinet using the four screws provided. Insert the screws through the front holes.

Limited Warranty

ONE-YEAR LIMITED WARRANTY

Within the 48 contiguous United States, for one year from the date of purchase, when this appliance is operated and maintained according to instructions attached to or furnished with the product, warrantor will pay for factory-specified parts and repair labor to correct defects in materials or workmanship. Service must be provided by a designated service company. Outside the 48 states, all parts are warranted for one year from manufacturing defects. Plastic parts, shelves and cabinets are warranted to be manufactured to commercially acceptable standards, and are not covered from damage during handling or breakage.

ITEMS WARRANTOR WILL NOT PAY FOR:

1. Service calls to correct the installation of your appliance, to instruct you how to use your appliance, to replace or repair fuses or to correct wiring or plumbing.
2. Service calls to repair or replace appliance light bulbs or broken shelves. Consumable parts (such as filters) are excluded from warranty coverage.
3. Damage resulting from accident, alteration, misuse, abuse, fire, flood, acts of God, improper installation, installation not in accordance with electrical or plumbing codes, or use of products not approved by warrantor.
4. Replacement parts or repair labor costs for units operated outside the United States.
5. Repairs to parts or systems resulting from unauthorized modifications made to the appliance.
6. Expenses for travel and transportation for product service in remote locations.
7. The removal and reinstallation of your appliance if it is installed in an inaccessible location or is not installed in accordance with published installation instructions.

DISCLAIMER OF IMPLIED WARRANTIES; **LIMITATION OF REMEDIES**

CUSTOMER'S SOLE AND EXCLUSIVE REMEDY UNDER THIS LIMITED WARRANTY SHALL BE PRODUCT REPAIR AS PROVIDED HEREIN. IMPLIED WARRANTIES, INCLUDING WARRANTIES OF MERCHANTABILITY OR FITNESS FOR A PARTICULAR PURPOSE, ARE LIMITED TO ONE YEAR. WARRANTOR SHALL NOT BE LIABLE FOR INCIDENTAL OR CONSEQUENTIAL DAMAGES. SOME STATES DO NOT ALLOW THE EXCLUSION OR LIMITATION OF INCIDENTAL OR CONSEQUENTIAL DAMAGES, OR LIMITATIONS ON THE DURATION OF IMPLIED WARRANTIES OF MERCHANTABILITY OR FITNESS, SO THESE EXCLUSIONS OR LIMITATIONS MAY NOT APPLY TO YOU. THIS WARRANTY GIVES YOU SPECIFIC LEGAL RIGHTS AND YOU MAY ALSO HAVE OTHER RIGHTS, WHICH VARY FROM STATE TO STATE.

FELIX STORCH, INC.

770 Garrison Avenue
Bronx, NY 10474

Phone: (718) 893-3900

Fax: (844) 478-8799

www.summitappliance.com



For parts and accessory ordering,
troubleshooting and helpful hints, visit:

www.summitappliance.com/support