

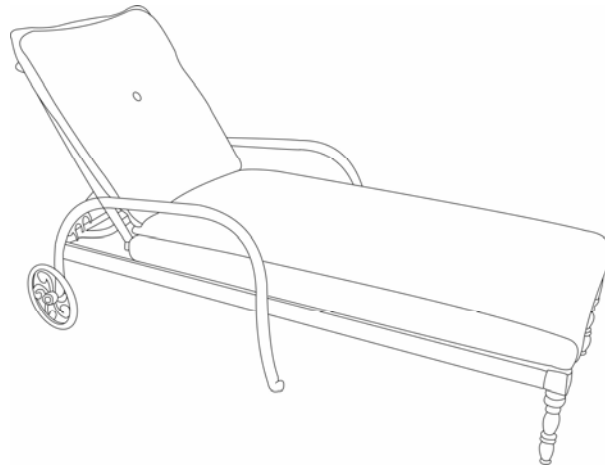







Thank you for purchasing this quality product. Be sure to check all packing materials carefully for small parts that may have come loose inside the carton during shipment. Please read all instructions carefully before starting the assembly process.

CAUTION: Some items and/or the components are cumbersome and heavy. Therefore, the assistance of one or more people is recommended in order to prevent personal injury and insure that the item and/or its components are not damaged during the assembly process. Perform all assembly steps on a flat, soft, non-abrasive surface to avoid scratching the finish. Do **not** over-tighten the screws or bolts.



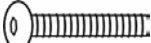











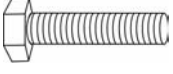

Hardware & Parts List

| No. | Description | Picture | Qty |
|-----|----------------------|---|-----|
| A | Left Arm |  | 1 |
| B | Right Arm |  | 1 |
| C | Seat Frame |  | 1 |
| D | Front Legs |  | 2 |
| E | Back Frame |  | 1 |
| F | Long Screws (M6x25) |  | 8 |
| G | Short Screws (M6x20) |  | 8 |

! KEEP THESE INSTRUCTIONS FOR FUTURE REFERENCE !

Assembly Instructions
Summer Silhouette™ Chaise Lounge
Model # 12256-002/012
Hardware & Parts List (Cont.)

| No. | Description | Picture | Qty |
|-----|----------------------|---|-----|
| H | Washers (M6) |  | 16 |
| I | Screw Covers (M6) |  | 16 |
| J | Bolts (M8x55) |  | 2 |
| K | Washers (M8) |  | 2 |
| L | Plastic Washers (M8) |  | 2 |
| M | Wheels |  | 2 |
| N | Plastic Bushings |  | 4 |
| O | Big Washers |  | 2 |
| P | Bolts (M8x25) |  | 2 |
| Q | Bolt Covers (M8) |  | 4 |
| R | Seat Cushion |  | 1 |
| S | Back Cushion |  | 1 |
| T | Hex Key |  | 1 |
| U | Wrench |  | 1 |
| V | Touch-up Paint |  | 1 |

! KEEP THESE INSTRUCTIONS FOR FUTURE REFERENCE !

I. Carefully place the seat frame upside down on a flat, soft non-abrasive surface. Align the holes on one of the front legs (D) with the holes in the corner of the seat frame. From inside the rim of the seat frame, attach the leg by inserting the short screws (G) with washers (H) through the seat frame into the holes in the leg. Do NOT completely tighten the screws until all four have been inserted. After inserting all four screws, securely tighten each screw using the hex key (T). Install the screw covers (I) on the screw heads. See **Figure I**. Repeat this same procedure for the other front leg (D). After both legs have been installed, carefully turn the seat over into the upright position.

Attach the left arm (A) to the outside of seat frame by aligning the holes in each end of the arm with the holes in the rim of the seat frame. From inside the seat rim, insert four of the long screws (F) with washers (H) through the holes in the seat frame and screw them into each end of the left arm as indicated in **Figure I**. Do NOT completely tighten the screws until all four have been inserted. After all four screws have been inserted, securely tighten each screw using the hex key (T). Install the screw covers (I) on each screw head. See **Figure I**. Repeat this same procedure for the right arm (B).

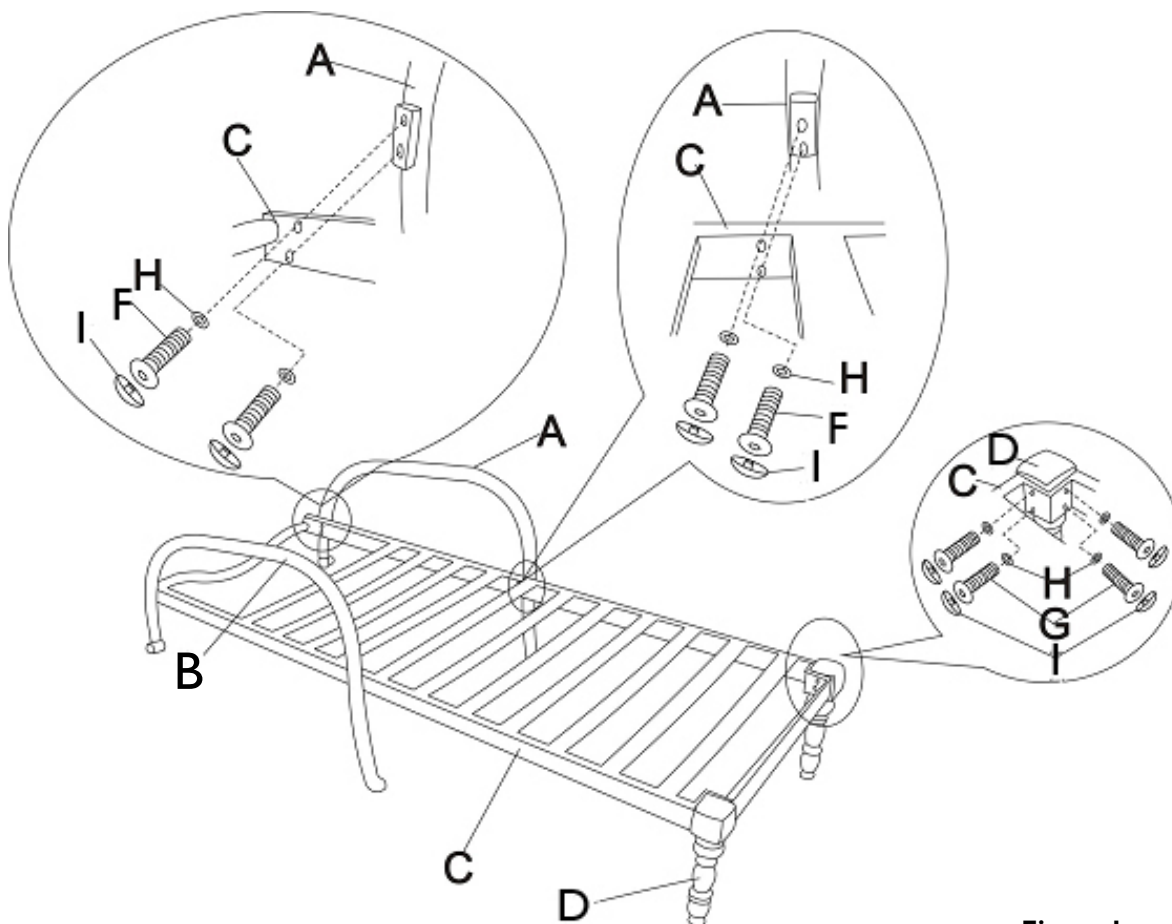

Figure I

! KEEP THESE INSTRUCTIONS FOR FUTURE REFERENCE !

Assembly Instructions
Summer Silhouette™ Chaise Lounge
Model # 12256-002/012

2. Attach one wheel (M) to the right arm using a bolt (P), big washers (O), and two plastic bushings (N). Make sure that the parts are assembled in the correct order and that their orientation is as indicated in **Figure 2**. One plastic bushing (N) should be between the wheel (M) and the arm. The other bushing should be between the wheel (M) and big washer (O). Make sure they are installed in the correct orientation. Use the hex key (T) and wrench (U) to tighten the bolt (P). Install the bolt cover (Q).

Repeat this same procedure for attaching the other wheel (M) to the left arm.

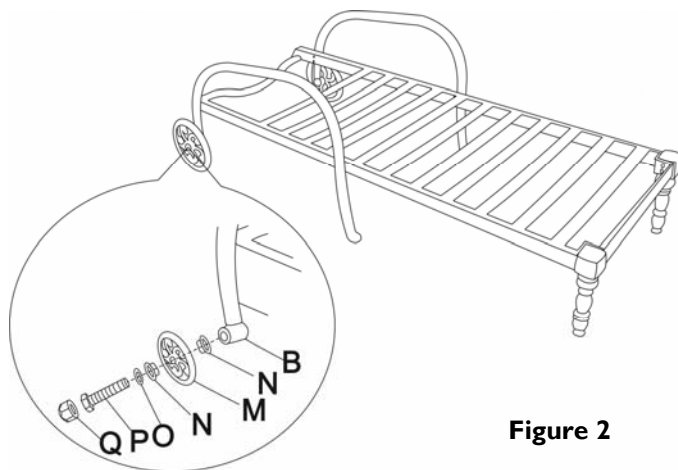
Figure 2

3. Install the back frame (E) inside the seat frame (C) by aligning the hole on the back frame with the hole in the rim of the seat frame and attach using the parts indicated in **Figure 3**. Insert the bolt (J) with washer (K) through the hole in the bottom of the back frame (E) and the plastic washer (L). Make sure the washer (K) is between the bolt (J) and back frame (E). The plastic washer (L) should be between the back frame (E) and seat frame (C). Screw the bolt into the hole in the inside rim of the seat frame and tighten using the hex key (T) and wrench (U). Install the bolt cover (Q).

Repeat this same procedure to attach the other side of the chaise back frame (E) to the seat frame (C).

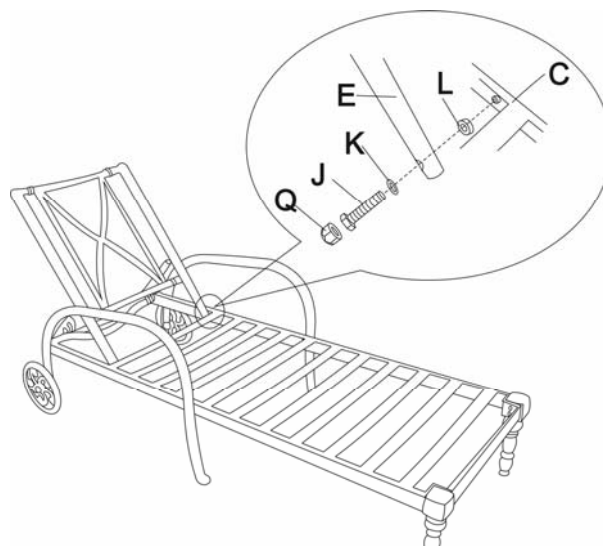
Figure 3

4. Place the seat cushion (R) and back cushion (S) on the chaise as indicated in **Figure 4**. Secure the cushions to the frame with the Velcro straps.

Note: Please keep the touch-up paint (V) for future use on your metal chaise parts if needed.

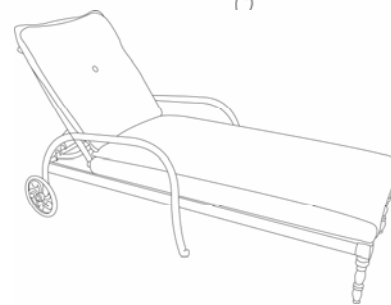
Figure 4

! KEEP THESE INSTRUCTIONS FOR FUTURE REFERENCE !