



INFRARED SAUNA SYSTEM

MODELS:LS-TCED-IC2,IC3,ICC3



Welcome

Thank you for purchasing our sauna products, we congratulate you on your new path to better health. We at Lifesmart are striving to become the best infrared sauna supplier in the country; our list of consumers increase daily and we believe your success is our success. We attribute this growth and success entirely to our customer satisfaction, the recognized health benefits, and the quality of our workmanship. At our factory, we use only the finest materials coupled with state-of-art construction and the highest safety standard in the industry.

Introduction

We congratulate you on your new path to better health! Thousands of users enjoy the benefits of an infrared sauna every day. Now you can enjoy the great benefits of far-infrared heat within the privacy of your own home.

Please read this manual carefully and thoroughly before using an Infrared Sauna for the first time. We recommend for you to keep this manual for future reference.

Benefits:

- Superior Detoxification: Removes Heavy Metals & Fat-stored Toxins
- Increased Cardiovascular Conditioning
- Stimulated Immune System
- Improved Circulation
- Pain Relief
- Weight Loss and Cellulite Reduction
- Beautiful Skin
- Stress Reduction

Features:

- High quality wood craftsmanship
- High quality electronic control system & digital control panel
- High quality MP3-Player
- Pre-assembled board and build-in electrical elements makes the installation easy
- Accurate temperature sensor
- Energy efficient
- Comfortable backrest
- Considerate detailed designs

Model List



LS-TCED-IC2



LS-TCED-IC3



LS-TCED-ICC3

Packing List for LS-TCED-IC2

For any missing parts please contact your local distributor.

Item Number:

1. Front Panel
2. Back Panel
3. Side Panel (L)
4. Side Panel (R)
5. Bottom Panel
6. Top Panel
7. Roof Cover
8. Bench Panel
9. Sitting Baffle
10. MP3 Connector
11. LED Color Light
12. LED White Light
13. Screws list

1. Front Panel
2. Back Panel
3. Side Panel (L)
4. Side Panel (R)

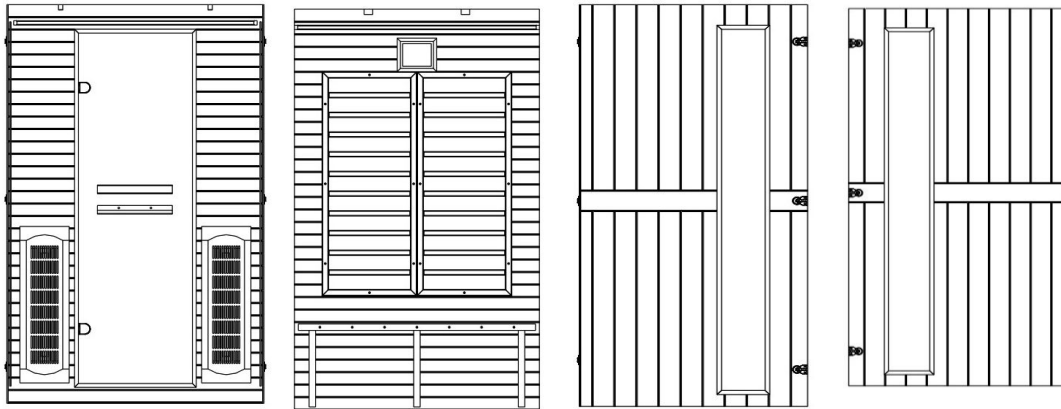

5. Bottom Panel
6. Top Panel
7. Roof cover

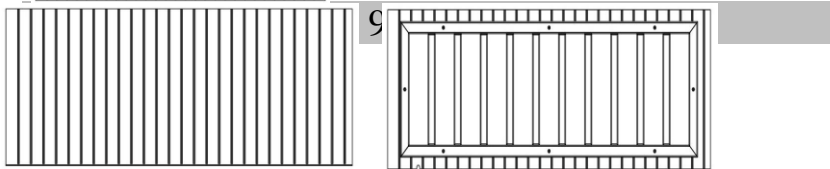
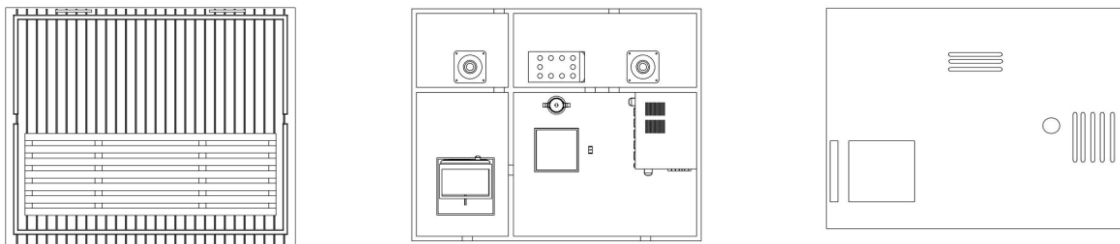

11. LED color light
12. LED white light
13. Screws list

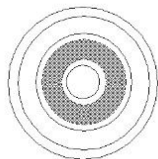

- (1) For installing inside door handle (2 pics).....
- (2) For installing roof cover (4 pics).....
- (3) For installing outside door handle (2 pics).....

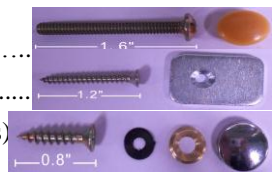

Packing List for LS-TECD-IC3

For any missing parts please contact your local distributor.

Item Number:

1. Front Panel
2. Back Panel
3. Side Panel (L)
4. Side Panel (R)
5. Bottom Panel
6. Top Panel
7. Roof Cover
8. Bench Panel
9. Sitting Baffle
10. MP3 Connector
11. LED Color Light
12. LED White Light
13. Screws list

1. Front Panel 2. Back Panel 3. Side Panel (L) 4. Side Panel (R)

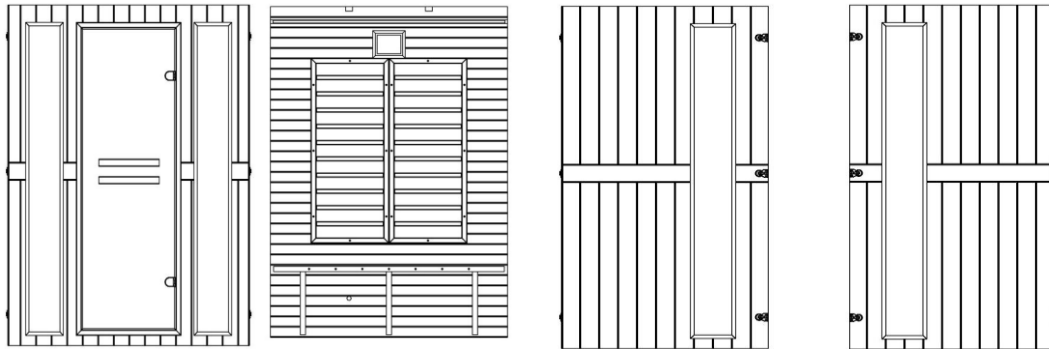

5. Bottom Panel 6. Top Panel 7. Roof cover

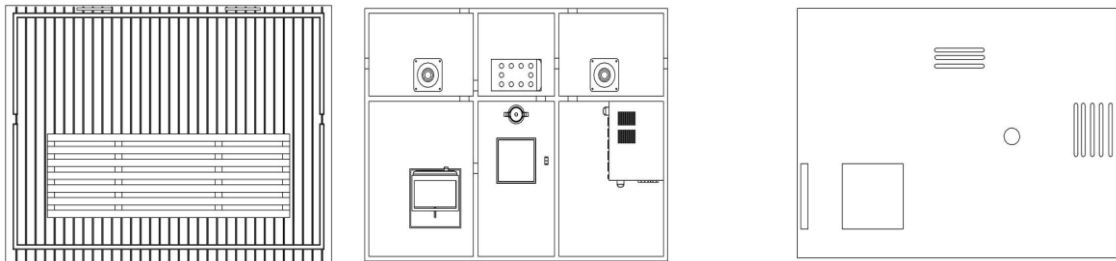

8. Bench Panel 9. Sitting baffle

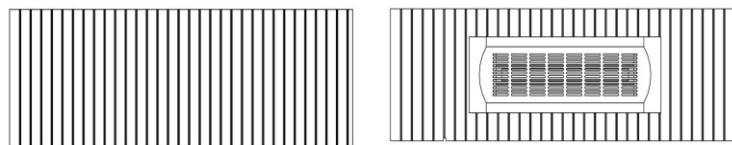

11. LED color light 12. LED white light 13. Screws list

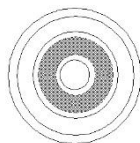
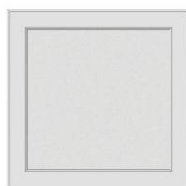

(1) For installing inside door handle (2 pics)

(2) For installing roof cover (4 pics).....

(3) For installing outside door handle (2 pics)



Packing List for LS-TECD-ICC3

For any missing parts please contact your local distributor.

Item Number:

- 1.Front Panel 2. Back Panel(R) 3. Back Panel (L) 4.Bottom Panel 5.Front Panel(R) 6.Front Panel(L) 7.Roof Panel 8.Roof Cover 9.Bench Panel (Long) 10.Bench Panel(Short) 11.Sitting Baffle(Long) 12.Sitting Baffle(Short) 13. MP3 Connector 14.LED color light 15.LED white light 16.Screws list

1. Front Panel 2.Back Panel(R) 3.Back Panel(L) 4. Bottom Panel



- 5.Front Panel(R) 6.Front Panel(L) 7. Roof Panel 8.Roof Cover

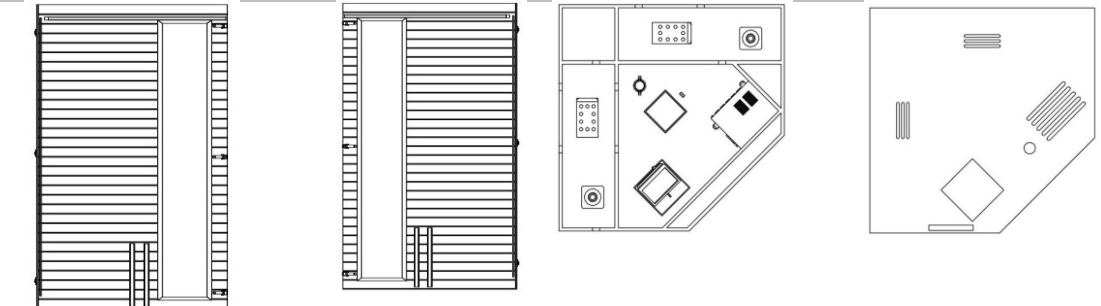

- 9.Bench Panel(Long) 10.Bench Panel(Short) 11.Sitting Baffle(Long)

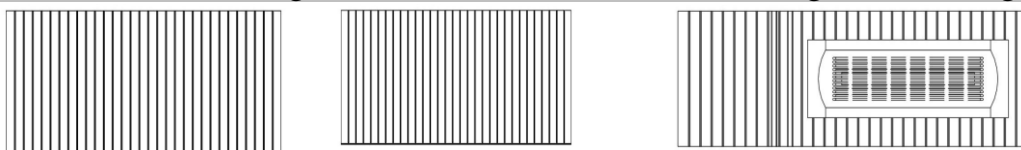

- 12.Sitting Baffle(Short) 14.LED color light

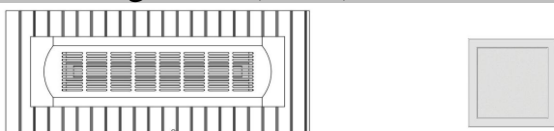

- 15.LED white light 16.Screws list

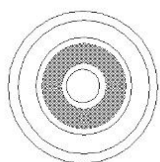

- (1)For installing inside door handle(2pics)
 (2)For installing roof cover(5 pics)
 (3)For installing outside door handle(2pics)



Installation Requirements

1. Do not plug any other appliances into the outlet with your infrared sauna.
2. Only 110/120V outlet is required for those three models.
3. Install the sauna on a completely level floor.
4. Do not spray the exterior with water. If the floor is damp, install a floor separator to keep the sauna high & dry.
5. Do not store flammable objects or chemical substances near the sauna.
6. The sauna must be placed indoors and in a dry area. Moisture will cause damage to the interior and exterior of the sauna.

Assembly Instructions for LS-TCED-IC2 ,IC3

Assembly of the sauna requires at least 2 adults to complete. Please read the instructions thoroughly before and during assembly to ensure proper installation of the sauna.

<1> LOCATION OF SAUNA

When you find a good location for your sauna, please notice the following.

1. The main power cord on the sauna must be easily accessible.
2. The location must be dry and leveled.
3. Please take out the backrest if it is behind the bottom panel.

<2> PLACING BOTTOM PANEL

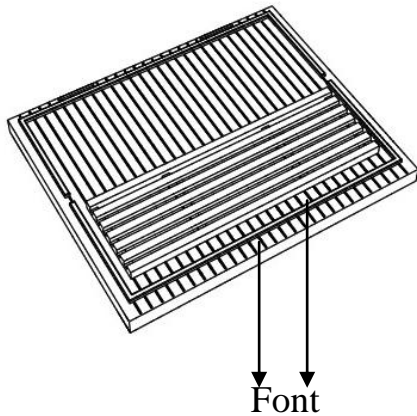

For Model-LS-TCED-IC2

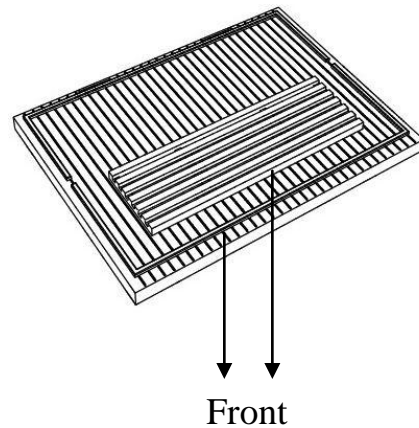

For Model-LS-TCED-IC3

Place the bottom panel on the floor. Make sure that the **FRONT** direction of your sauna room.

<3> CONNECTING THE BACK PANEL TO BOTTOM PANEL



LS-TCED-IC2



LS-TCED-IC3

Put the back panel onto the bottom panel and make sure its inner side stands against the wooden beam on the bottom panel.

Align the back panel with side panes's corresponding outside-buckles

<4> INSTALLING RIGHT PANEL AND BACK PANEL WITH BUCKLES

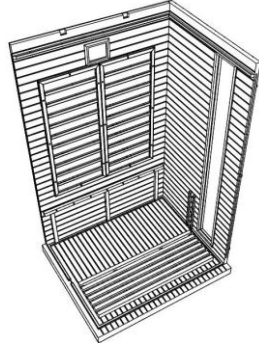

LS-TCED-IC2

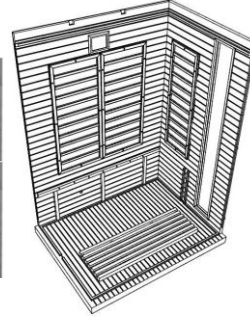

LS-TCED-IC3

<5> INSTALLING LEFT PANEL AND BACK PANEL WITH BUCKLES



LS-TCED-IC2

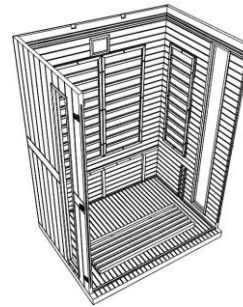
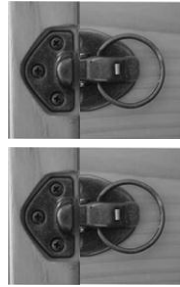

LS-TCED-IC3

<6> INSTALLING BENCH HEATER PANEL & PLUG IN THE CABLE

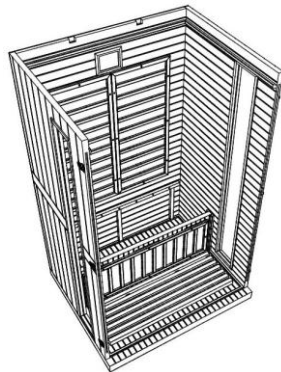

LS-TCED-IC2

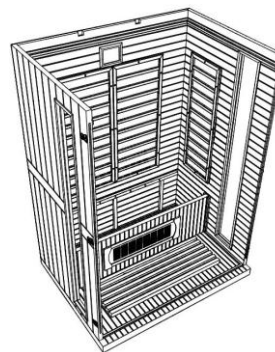

LS-TCED-IC3

Slide down the bench heater panel by lining up its sides with the vertical guides on left side panel .

1. The heater grills is facing outward (toward the front of the sauna)
2. Push the bench heater panel all the way down until it is touching the bottom panel and securely in place.

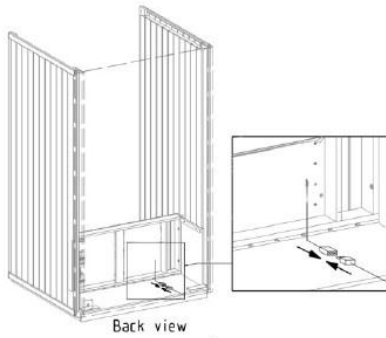

NO.1 : Connect the plug of the bench heater to connector A and make sure they are tightly connected.

NO.2 : Connect the plug of the floor heater to connector B and make sure they are tightly connected.

<7>INSTALLING THE BENCH

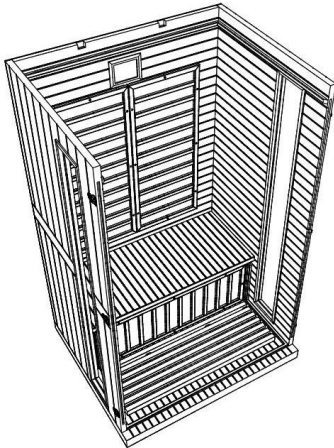

LS-TCED-IC2

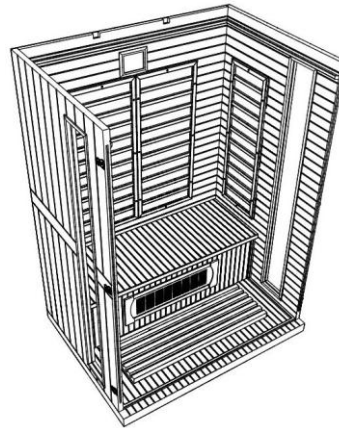

LS-TCED-IC3

1. Install the bench by sliding it over the horizontal bench guides on the side panels.
2. Push the bench all the way in until it can touch the back panel and is securely in place.
3. Make sure of the bench position so that the smooth and finished side of the bench are facing up and forward.

<8> PLACE THE FRONT PANEL AND CONNECT IT TO THE SIDE PANELS WITH BUCKLES

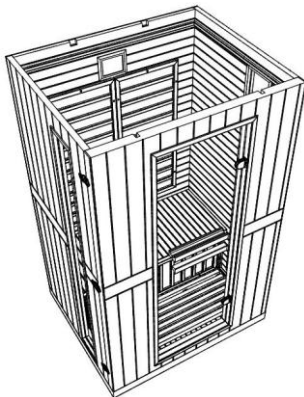

LS-TCED-IC2

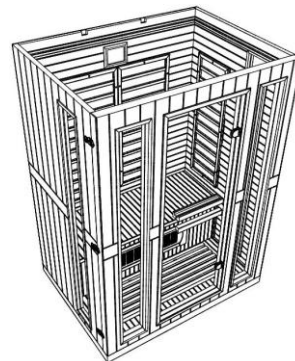

LS-TCED-IC3

<8> PLACING TOP PANEL

Lower the top panel onto the assembled panels.

1. Gently place the top panel onto the rest of the assembled panels. When four corners are in place, gently push down the top panel from the outside corners until it is snugly fit over the rest of panels.
2. Make sure the cable do not get pinched between the panels.

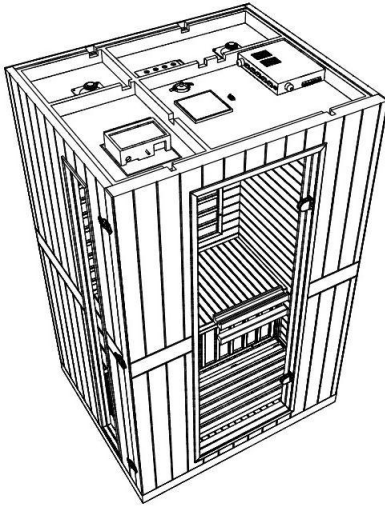

LS-TCED-IC2

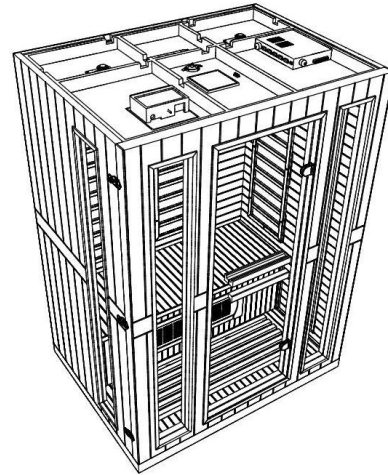

LS-TCED-IC3

3. Please screw the ceiling with the side panels with the provided screws so that the ceiling and the side panels can connect closely.

<9> THE MAIN POWER CONNECTION ON THE TOP PANEL

1. Connect the heater wires
2. Connect the control panel wires.
3. Check to be sure that all connections to the control box are secure.

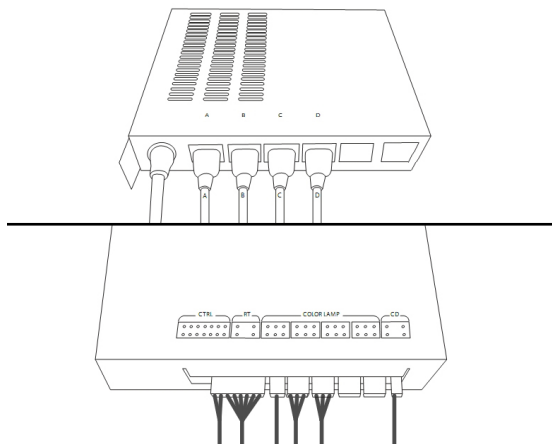

<10 PLACE THE FOOR COVER ONTO THE ROOF PANEL

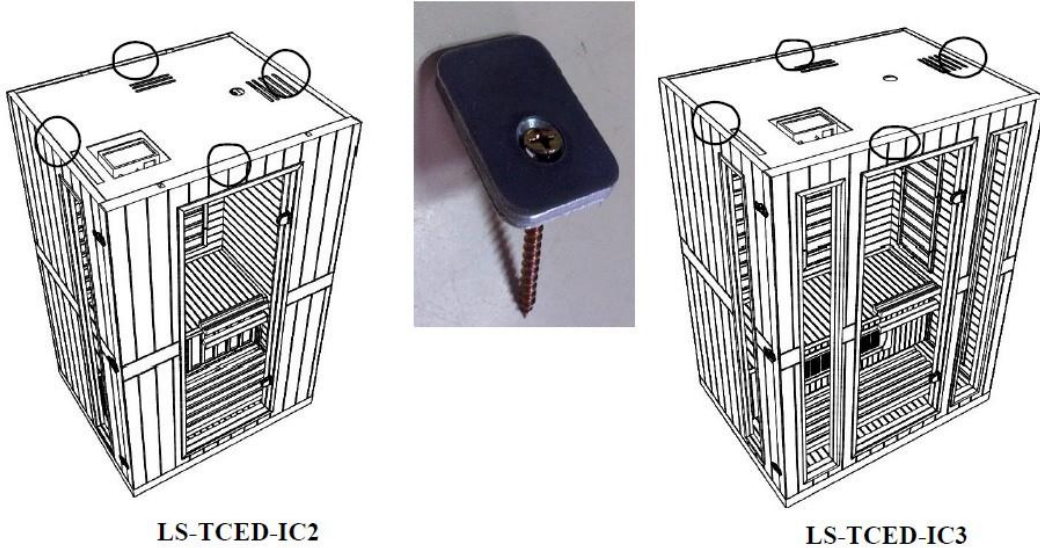

Place the roof cover onto the roof panel. Screw down the 4 pieces metal parts in the middle of each panel so that the metal parts can be put tightly against the roof to avoid distorting.

<11> ENJOY YOUR SAUNA!

Plug in the main power cord into the wall outlet and power up your sauna.

Plug your MP 3 Player into the connector with the wire provided. Your

MP3 Player controls the Volume thru the included speakers.

Grab some towels, a glass of water and step into your sauna and enjoy the benefits of your sauna!!

Assembly Instructions for LS-TCED-ICC3

Assembly of the sauna requires at least 2 adults to complete. Please read the instructions thoroughly before and during assembly to ensure proper installation of the sauna.

<1> LOCATION OF SAUNA

When you find a good location for your sauna, please notice the following.

1. The main power cord on the sauna must be easily accessible.
2. The location must be dry and leveled.
3. Please take out the backrest if it is behind the bottom panel.

<2> PLACING BOTTOM PANEL

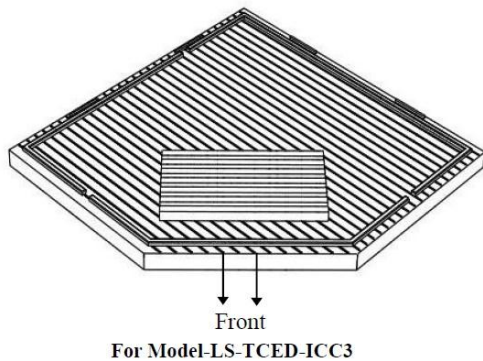

Place the bottom panel on the floor. Make sure that the **FRONT** direction of your sauna room.

<3> PLACING THE RIGHT BACK PANEL ONTO BOTTOM PANEL

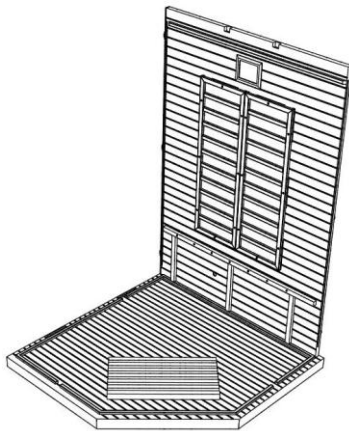

Put the right back panel onto the bottom panel and make sure its inner side stands against the wooden beam on the bottom panel.

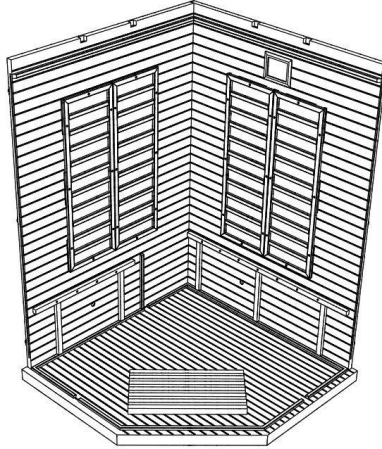
<4> PLACING THE LEFT BACK PANEL ONTO BOTTOM PANEL

Put the right back panel onto the bottom panel and make sure its inner side stands against the wooden beam on the bottom panel. Meanwhile connect it to the right back panel with buckles.

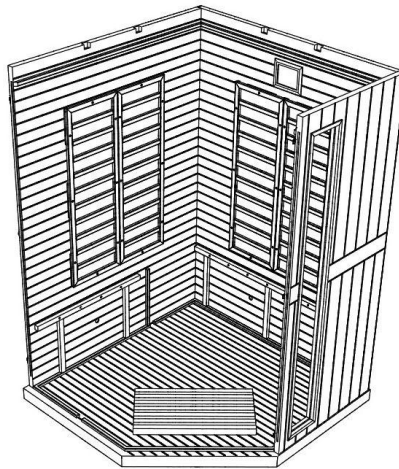
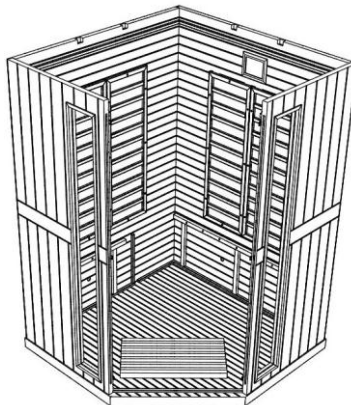
<5> INSTALLING RIGHT SIDE PANEL AND RIGHT BACK PANEL WITH BUCKLES**<6> INSTALLING LEFT SIDE PANEL AND LEFT BACK PANEL WITH BUCKLES**

<7>INSTALLING BENCH HEATER PANEL & PLUG IN THE CABLE

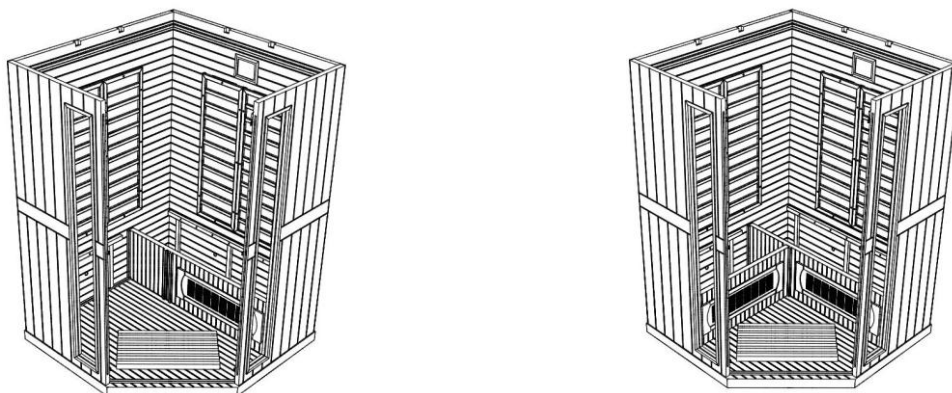

Slide down the bench heater panel by lining up its sides with the vertical guides on left side panel .

NO.1 : The heater grill is facing outwards (towards the front of the sauna)

NO.2 : Push the bench heater panel all the way down until it is touching the bottom panel and securely in place.

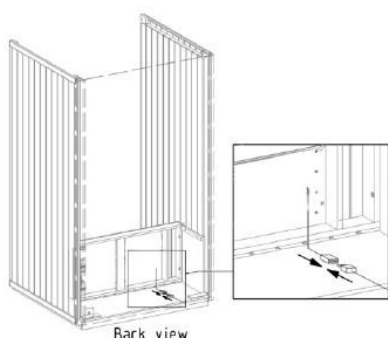

NO.1 : Connect the plug of the bench heater to connector A and make sure they are tightly connected.

NO.2 : Connect the plug of the floor heater to connector B and make sure they are tightly connected.

<8>INSTALLING THE BENCH

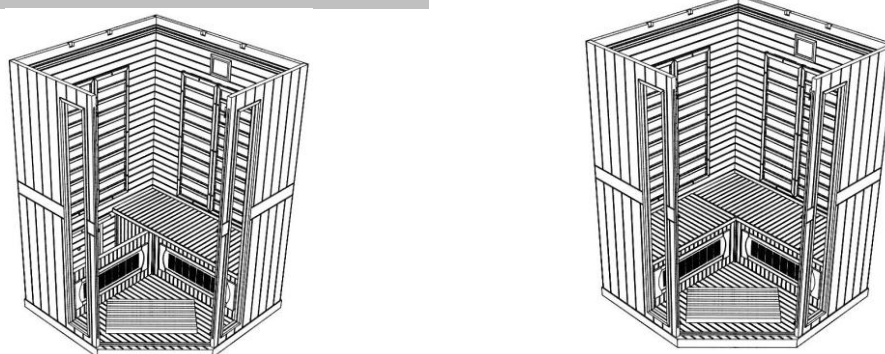

1. Install the bench by sliding it over the horizontal bench guides on the side panels.
2. Push the bench all the way in until it can touch the back panel and is securely in place.
3. Make sure of the bench position so that the smooth and finished side of

the bench are facing up and forward.

15

<9> PLACE THE FRONT PANEL AND CONNECT IT TO THE SIDE PANELS WITH INSIDE BUCKLES

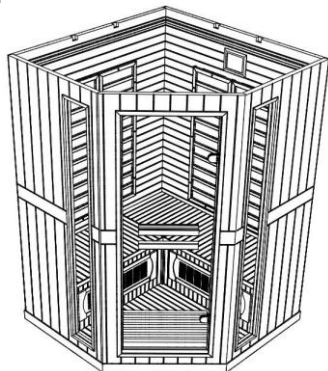

<10> PLACE THE TOP PANEL

Lower the top panel onto the assembled panels.

1. Gently place the top panel onto the rest of the assembled panels. When four corners are in place, gently push down the top panel from the outside corners until it is snugly fit over the rest of panels.
2. Make sure the cable do not get pinched between the panels.

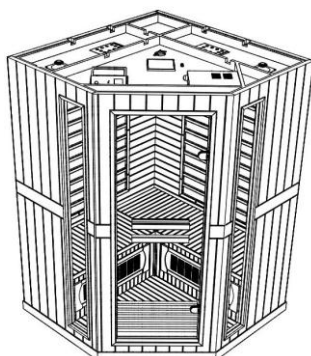

3. Please screw the ceiling with the side panels with the provided screws so that the ceiling and the side panels can connect closely.

<11> THE MAIN POWER CONNECTION ON THE TOP PANEL

1. Connect the heater wires
2. Connect the control panel wires.
3. Check to be sure that all connections to the control box are secure.

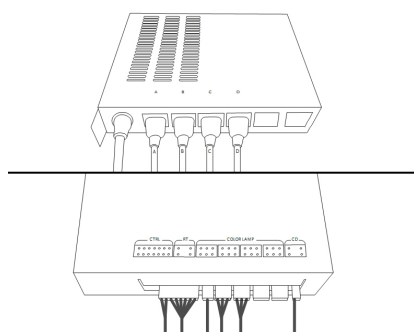

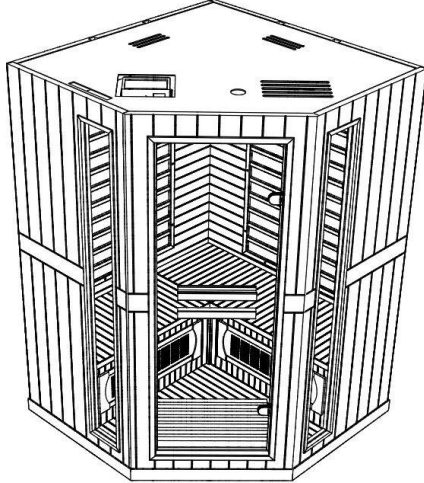
<10 PLACE THE FOUR COVER ONTO THE ROOF PANEL

Place the roof cover onto the roof panel , screw down the 5 pieces metal parts in the middle of each panel so that the metal parts can be put tightly against the roof to avoid distorting.

<11> ENJOY YOUR SAUNA!

Plug in the main power cord into the wall outlet and power up your sauna.

Plug your MP 3 Player into the connector with the wire provided. Your

MP3 Player controls the Volume thru the included speakers.

Grab some towels, a glass of water and step into your sauna and enjoy the benefits of your sauna!!

Digital Control Panel Operating Instructions

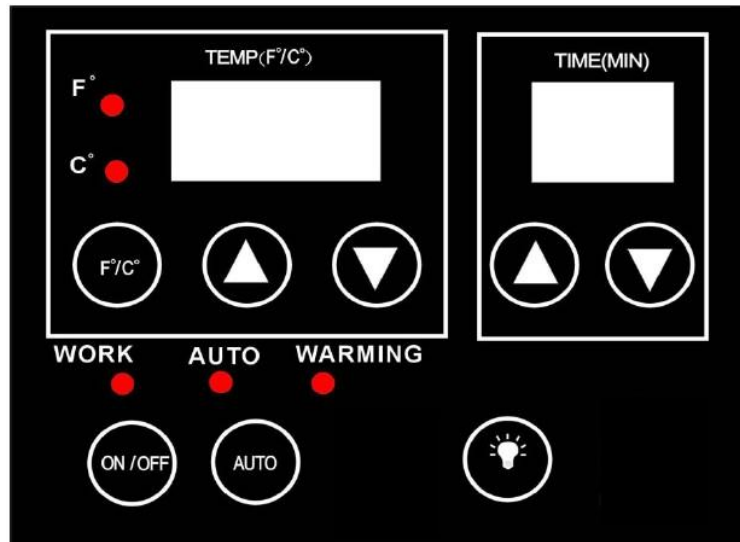

1. Power on

Plug the main power cord into the wall outlet. Press the “On/Off” button one time, the control panel is now operable, but the heaters are not on. You can now use the radio and lights.

2. Warming

Press “On/Off” button again, then the “Warming” light is on, which indicates the heaters are working. To turn off the sauna, press the ON/OFF button.

3. Lighting

The reading light can be turned on or off by pressing  button at any time, the color lights can be turned on/off by the small switch on the roof or the remote control.

4. Pre-setting

“AUTO” button is for pre-setting the time you want your sauna to turn on. Press “AUTO” button once. Pre-set the time you want your sauna to turn on with the UP/DOWN ARROWS. TEMP UP/DOWN ARROWS are for hour setting and TIME UP/DOWN ARROWS are for minute setting. The setting range is 00:00-23:59.

5. How to use MP3 connector

Plug your MP3 Player into the mini input jack. The controls on your player will operate the volume thru the speakers

6. Sauna Time Adjustment

Session time can be set between 0 and 90 minutes.

- a) Press TIME UP/DOWN ARROWS to adjust time, time value will increase or decrease by 1 minute at a time.
- b) By holding down the UP/DOWN ARROWS you can speed up the rate of change.
- c) Time light will be lit to indicate changes being made to time setting.
- d) If you don't input anything during 5 seconds, the TIME DISPLAY will stop flashing, the value will be stored in memory as preset value. Then the TIME DISPLAY value will show how much time is left in your sauna session decreasing 1 minute at a time.

7. Sauna Temperature Adjustment

Session temperature can be set between 77°-158° (25°-70°) (Recommend environment temperature is 68° (20°) and Recommend temperature settings are between 100°-130° (38°-54°)

- a) Press TEMP UP/DOWN ARROWS to adjust temperature, temperature value will increase or decrease by 1 degree at a time.
- b) By holding down the UP/DOWN ARROWS, you can speed up the rate of change.
- c) 0F(or 0 C) will be lit to indicate changes being made to temperature setting. If you don't input anything during 5 seconds, TEMPERATURE DISPLAY will stop; present value will be stored in memory as preset value and will be displayed at next start up. And the TEMPERATURE DISPLAY value shows the sauna room inside current temperature.
- d) During session time, when the temperature reaches the setting level on the control panel, "Warming" indicator light will be off, micro-control will force the heaters to stop heating and keep a constant-temperature status. The heaters will turn off and on periodically in order to maintain the desired temperature inside the sauna.

8. Switch between 0F and 0 C

You can alternate between Fahrenheit and Celsius while in setting mode by pressing 0F / 0 C buttons.

Things To Know

1. Set up the desired session temperature and time using the control panel. (suggested 100°F -130°F)
2. Allow approximately 15 to 20 minutes for the sauna to warm up before beginning a session.
3. Recommend sauna session use is around 30-45 minutes.
4. The heaters automatically maintain the desired temperature inside the sauna
5. The ceiling vent can be opened at any time to for air circulation.
6. Always drink plenty of water before, during, and after a session. Doing so will replenish lost fluids from the body through perspiration.
7. Take a hot shower or bath prior to the sauna session will further promote perspiration. However, dry off thoroughly before going into the sauna because excessive water will stain or warp the wood. A shower after the session is refreshing and rinsing perspiration from the body.
8. To absorb perspiration and keep the sauna tidy during the session, place a towel on the bench and floor of the sauna. Keep one towel handy to wipe excessive sweat from your body.
9. The interior wood is aromatic and adds to the enjoyment of your sauna session. If you feel the odor is too strong during the first few months of usage, you can wipe the wood with a damp cloth to minimize the odor.

Recommendation for Use

- 1. To regulate the temperature inside the sauna during your session, use the roof vent or the door (by setting it at an angle).**
- 2. If you need more cooling, simply leave the door open until the air around you feel comfortable.**
- 3. Drink plenty of fluids prior to, during, and after your sauna session.**
- 4. If you take a hot /warm shower or bath before your sauna session, you may perspire more. Try it with and without bathing or showering first to determine which way you prefer.**
- 5. To utilize the sauna's heat therapy effect, give your hair a hot oil treatment while in the sauna. Put oil or treatment into your hair and wrap it with towel. After the session is over, rinse your hair thoroughly.**
- 6. Use at least 2-3 towels; sit on one towel folded over several times for added cushioning. Put another towel on the floor to absorb excess sweat. A third towel draped over the knees may aid you in comfort and useful to towel off the sweat.**
- 7. Be sure to towel off excess sweat during your session to help the body perspire more freely.**
- 8. To help relieve sore and tense muscles, massage the affected areas while in sauna to help heal faster.**
- 9. Do not put any lotions or oils on the body or face when using the sauna. This may block the pores.**
- 10. Shaving your face or legs with a razor while profusely sweating in a sauna yields an incredibly smooth result without the use of gels or foams.**
- 11. Do not eat anything at least an hour before your sauna session. It is better to go in the sauna on an empty stomach. You are more likely to feel uncomfortable sitting in a sauna with a full stomach.**
- 12. To make the most out of your sauna session, work your muscles while in the sauna. Stretch your arms and legs; massage your neck and feet, etc.**
- 13. You can benefit from the relaxing and soothing effects of a regular sauna session by going to sleep afterwards. The peaceful and relaxed state rendered by a sauna session will help you sleep easier and better.**
- 14. At the first sign of cold or flu, increasing your sauna sessions may be beneficial in boosting your immune treatment and decreasing the reproductive rate of the viruses. Consult your physician for the proper treatment and care for this or any other conditions.**
- 15. To treat your ankles and feet more effectively, elevate them while inside the sauna. Any area that you wish to achieve a specific deep heating effect should be moved as close to one of the heaters as feels comfortable.**
- 16. After the session is over, do not immediately jump into the shower. Since your body was heated up during the session, it will continue to sweat even after the heaters are off. Sit in the sauna with the door open and allow the body to sweat a little more as it cools off. Once you feel comfortable enough, take a warm (or cool) shower to rinse the sweat off your body completely.**

Safety

Read all health and safety instructions. If in doubt as to the advisability of using your infrared sauna, consult with your physician prior to use. If you feel light-headed or heat exhaustion during session, exit the sauna immediately.

1. Read and follow all instructions carefully.
2. When installing and using this electrical equipment, basic safety precautions should always be followed.
3. To reduce the risk of injury, do not allow children to use the sauna unless they are closely supervised at all.
4. Do not use the sauna immediately following strenuous exercise. Wait at least 30 minutes to allow the body to cool down completely.
5. Excessive temperature has a high potential for causing fetal damage during the early months of pregnancy. **Pregnant or possibly pregnant women should contact their physician prior to using the sauna.**
6. Hypothermia Danger: Prolonged exposure to hot air will induce hypothermia. Hypothermia occurs when the internal temperature of the body reaches a level several degrees above the normal body temperature of 37°C (98.6 °F). While hypothermia has many health benefits, it is important not to allow your body's core temperature to rise above 103°F. Symptoms of excessive hypothermia include dizziness, lethargy, drowsiness, and fainting. The effects of excessive hypothermia may include failure to perceive heat, failure to recognize the need to exit, unawareness of impending hazard, fetal damage in pregnant women, physical inability to exit the sauna, and unconsciousness.
7. The use of alcohol, drugs, or medications prior to or during the sauna session may lead to unconsciousness.
8. **Persons suffering from obesity or with a medical history of heart disease, low or high blood pressure, circulatory system problems, or diabetes should consult a physician prior to using the sauna.**
9. **Persons using medications should consult a physician before using the sauna since some medications may induce drowsiness while others may affect heart rate, blood pressure, and circulation.**
10. Never sleep inside the sauna while the unit is in full operation.
11. DO NOT use any type of cleaning agents on the interior of the sauna.
12. DO NOT stack or store any object on top of or inside the sauna.
13. If power supply cord becomes damaged it must immediately be replaced by the manufacturer, or its agent, or a similarly qualified person to avoid a hazard.
14. DO NOT use the unit during an electrical storm, as there is a remote risk of shock.
15. Altering or tampering of any electrical connections on the power supply will void the manufacturer's warranty.
16. Dry your hands before handling electrical controls. Never unplug the power cord or adjust the controls with wet hands or when you have wet bare feet. A danger of electrical shock exists.
17. DO NOT attempt any repair without consulting the manufacturer first. Unauthorized repair attempts will void manufacturer's warranty.
18. All natural wood articles have variations in the color, grain, and irregularities such as knots, and fine cracks. These characteristics are a part of the natural beauty of the wood, and in no way should be considered defective.

Important Safeguards For Your Sauna

1. RE AD INSTRUCTIONS -- All the safety and operating instructions should be read before the sauna is installed and operated.
2. RE TAIN INSTRUCTIONS -- The safety and operating instructions should be retained for future reference.
3. FO LLOW INSTRUCTIONS -- All operating and usage instructions should be followed at all times.
4. CL EANING -- Unplug the sauna from the wall outlet before cleaning DO NOT use liquid cleaners or aerosol cleansers inside the sauna. Use a damp cloth for cleaning.
5. AT TACHMENTS-- Do not use any attachments that are not recommended by the manufacturer, may be hazardous.
6. WA TER OR MOISTURE—DO NOT use your sauna near water, e.g. near a bathtub, in a wet basement, or near a swimming pool and the like.
7. PO WER-CORD PROTECTION-- Power supply cord should be routed so it is not likely to be walked on or pinched by items placed upon or against it.
8. LI GHTING-- For added protection for your sauna during a lightning storm, or when it is left unattended and unused for long time, unplug it from the wall outlet.
9. OV ERLOADING-- Do not overload wall outlet and extension cord as this can result in a risk of fire or electric shock.
10. SER VICING-- Always unplug your sauna from the wall outlet before servicing.
11. REP LACEMENT PARTS--When replacement parts are required, be sure it is specified by the manufacturer or have the same characteristics as the original parts. Unauthorized substitutes may result in fire, electric shock or other hazards.
12. SAF ETY CHECK--Upon completion of any service or repairs to your sauna, ask the service technician to perform safety checks and determine that your sauna is in proper operation condition.

Cleaning and Maintenance

- Before using your infrared sauna for the first time, clean the inside of the sauna with a damp cloth. If the smell of the sauna is strong at first, that is normal and please open the door while the sauna is working. The smell will diminish within a weekend.
- Use furniture polish to clean the exterior.
- We recommend placing a soft towel on the floor and on the bench of the sauna to absorb perspiration during sauna use.
- Scratches and stains on the sauna can be removed by simply using fine grade sandpaper over the damaged area.

Troubleshooting Guide

| | Problems | Explanations | Solutions |
|---|--|--|--|
| 1 | Power indicator light not on | Power cord is not plug-in | 1. Check for power to the outlet. 2. Check connection between power cord and main control unit. |
| | | The fuse is burned out | Check or replace the fuse. |
| 2 | Function indicator light not on | The corresponding indicator light is broken or burned out. | Repair or replace the control panel. |
| | | The wiring or some electronic component in the circuit has failed | Repair or replace what has failed in that circuit. |
| 3 | Infrared Heater will not heat up | The heater is broken | Replace with a new heater of the same specifications. |
| | | Its life will be shortened gradually from excessive use. | |
| | | The fuse is burned out. | Check or replace the fuse. |
| | | The wiring connection for the heater is loose or in the wrong location. | Check it, and reconnect tightly. |
| | | The circuit board is not functioning. | Check power output on the circuit board |
| 4 | Sauna room not maintaining correct temperature | Problem with heater. | See Item #3. |
| | | Incorrect setting on control panel | Reset it. |
| | | The temperature sensor wire may be loose or broken. | Check sensor wire connection and condition. Check to see if sensor head is visible inside the sauna room. |
| 5 | Peculiar burning smell | Circuit problems (broken component, short circuit, failure of controlling system) causing the burning of some component in the electrical system | 1. Unplug sauna, check the voltage. |
| | | | 2. Find the objects with problems |
| | | | 3. Replace the parts |
| 6 | The light not working | The light bulb is burned out. Replace light | Replace light bulb. |
| | | The bulb is not secured in the base | 1. Make sure the bulb is tight enough to make good contact in the light fixture. 2. Check the lighting protection fuse. |
| | | The socket is broken. | Replace it. |
| | | Problems with electrical control panel. | Check or replace the panel. |
| 7 | No sound or poor sound from speakers | The speaker is broken or speaker is loose | 1. Check speaker wire. 2. Check speaker |
| | | The wire connection is loose | Check connectors to be sure they make good contact |
| | | CD-player is not turned on. | Turn on the CD-player. |
| | | CD-player is not functioning | 1. Check faceplate contact on the CD player. |

| | | | |
|--|--|--|----------------------------------|
| | | | 2.Check fuse in the fuse holder. |
|--|--|--|----------------------------------|

Registration

Please register your product within 30 days from the date of purchase to receive a full warranty. Registration may be done with one of the following 3 options:

1) Register online at www.lifesmartproducts.com (product registration tab)

2) E-mail us at Registration@lifesmartproducts.com (Provide the information below)

3) Call Technical Support at 1-866-484-2066 and provide us the following information

First Name: _____ Last Name: _____

Home Address: _____

City _____ State _____ Zip _____

Phone: _____ Fax: _____

E-mail Address: _____

Purchase Date: _____

Place of Purchase: _____

Model Number: _____

Our unit is a: 2 person? 3 person? Corner?

Serial Number: _____

Limited Manufacturer Warranty

1 Year Limited Warranty: LIFESMART warrants this sauna against defects in materials and workmanship **on functional parts**, for a period of 1 year from the original date of purchase. **Your sales receipt showing the date of purchase of the product is your proof of purchase.** Keep it in a safe place for future reference.

Manufacturer Warranty

All LIFESMART products are manufactured with the highest quality materials and are warranted to be free from defects in material and workmanship at the time of purchase. This limited warranty applies to products manufactured or distributed by the LIFESMART brand name, are delivered in the continental United States, and extends to the original purchaser, or gift recipient. This warranty becomes valid at the time of purchase and terminates either by the specified time frame listed above and/or owner transfer (unless otherwise authorized by LIFESMART, as the manufacturer). Any extended warranties (warranties that cover above and beyond this manufacturer warranty) that are sold through a retailer or third party, are not directly correlated with this LIFESMART limited warranty, and may be redirected to said retailer or third party for coverage.

Extent of Warranty

This warranty extends through the manufacturer of the product, and covers functional parts only. Cosmetics are not covered, unless unequivocally determined it is a manufacturer/workmanship defect. Note that surface cracks are not considered defects in material or workmanship, as they are normal characteristics of all wood. Unless LIFESMART was the direct shipper, shipping damage should be addressed with the shipping company, retailer, or place of purchase, prior to making a claim to LIFESMART, as the manufacturer.

The manufacturer's sole obligation under this warranty shall be limited to furnishing the original purchaser replacement parts for units deemed *repairable* by the LIFESMART warranty department. The purchaser may also opt to ship the product to LIFESMART to have it repaired. The purchaser will be responsible to prepay any shipping charges (both ways), export taxes, custom duties and taxes, or any other charges associated with the transportation of the unit. In addition, the purchaser is responsible for insuring any parts shipped or returned, if desired. For products the warranty department deems *unrepairable, or discontinued*, LIFESMART reserves the right to issue a refurbished product, or product similar in size and functionality as a replacement for the defective unit, *if available*. All exchanged parts and products replaced under this warranty will become the property of LIFESMART.

LIFESMART reserves the right to change manufacturers of replacement parts or products for use, in order to cover any existing warranty. Any parts determined defective may be asked to be returned to LIFESMART or its representatives to validate a claim. Non-Warranty replacement parts will be warranted 30 days from the time the purchaser receives them.

The purchaser must present LIFESMART with proof of purchase documents (including the date of purchase) if requested. Any evidence of alteration, erasing, or

forgery of proof of purchase documents will be just cause to **VOID** this limited warranty. Products, in which the serial number has been defaced or removed, are not eligible for warranty coverage. Continued...

27

Warranty Limitations

This warranty does not apply if the unit has been subject to negligence, fabrication, misuse, abuse, or repairs (unless authorized verbally, or in writing, by an Authorized LIFESMART Representative) alteration by non **LIFESMART** authorized personnel, inappropriate installations, or any case beyond the control of **LIFESMART**.

Examples of warranty invalidation may also include, but are not limited to:

-
- Use of lacquer or paints in (and around) the saunas
- Sauna placed on non-approved Surfaces
- Electrical requirement deficiencies
- Use on Extension Cords/Timers/Surge Protectors/GFCI
- Outdoor applications
- Normal wear/tear/weathering
- Pet/Consumer accidents
- Purchases from dealers unauthorized by **LIFESMART** (Authorization in writing)

Disclaimers

LIFESMART shall not be liable for any loss due to use (or misuse) of the sauna or other **LIFESMART** products or other incidental or consequential costs, expense or damages without irrefutable foundations. Under no circumstances shall **LIFESMART** or any of its representatives be held liable for injury to any person or damage to any property, however arising. Any implied warranty shall have duration equal of the applicable warranty stated above. Specifications are subject to change without notice or obligation.

Legal Remedies

This limited warranty gives the original purchaser specific legal rights. Other rights may vary from state to state.

Warranty Limitations

life corp

smart



HD OWNER'S MANUAL
110V / 230V Models

LIFESMART OWNER'S MANUAL

Owner's Record

Locating the Spa Serial Number:

The spa serial number label is located on control box cover inside the equipment compartment. Equipment compartment access panel is below the spas 4-button topside control panel. You will need the spa model and serial number to properly register your spa and activate coverage. Write your spa information in the space provided.

DATE PURCHASED:

PURCHASED FROM:

SPA MODEL:

SERIAL NUMBER:

Please read this "Owner's Manual" carefully, as it is designed to provide you with the information you will need to ensure the safe, secure use of your spa.

IMPORTANT: Watkins Manufacturing Corporation reserves the right to change specifications and/or design without notification and without any obligation.

SPA DIMENSIONS

| Model | Spa Seating | Length | Width | Height | Dry Weight | Electrical Specs 60Hz |
|-----------|-------------|--------|-------|--------|------------|-----------------------|
| BERMUDA | 4 person | 5'2" | 5'10" | 34¼" | 270 LBS. | 110V, 9A |
| KEY LARGO | 4 person | 6'5" | 5'6" | 29" | 244 LBS. | 110V, 9A |
| ANTIQUA | 5 person | 6'3" | 6'3" | 34" | 424 LBS. | 110V, 9A |
| BARBADOS | 7 person | 6'8½" | 6'8½" | 34" | 440 LBS. | 110V, 9A |
| CORONADO | 7 person | 6'8½" | 6'8½" | 34" | 478 LBS. | 230V, 26A |

CAUTION

DO NOT OPERATE SPA BEFORE READING THIS MANUAL

Failure to read this manual & follow its instructions may result in unsafe operation and or permanent damage to your portable spa.

Most cities, counties, states, and countries require permits for exterior construction and electrical circuits. In addition, some communities have codes requiring residential barriers such as fencing and/or self-closing gates on the property to prevent unsupervised access to a pool or spa by children. Be sure to check with your local agencies for specific requirements.

If you need additional information and/or assistance, please contact Customer Service at 888-961-7727 Ext. 8440

TABLE OF CONTENTS

| TITLE | PAGE |
|---|-------------|
| CONTENTS | |
| SAFETY INFORMATION | |
| IMPORTANT SAFETY INSTRUCTIONS | 1 |
| IMPORTANT SPA INSTRUCTIONS..... | 4 |
| INSTALLATION | |
| PLANNING A LOCATION FOR YOUR SPA..... | 5 |
| PLACING THE SPA..... | 6 |
| EQUIPMENT ACCESS | |
| EQUIPMENT ACCESS PANEL | 7 |
| ELECTRICAL REQUIREMENTS | |
| ELECTRICAL | 8 |
| CONFIGURING SYSTEM | 10 |
| ELECTRICAL WIRING DIAGRAM FOR 230V USE..... | 11 |
| CONTROL PANEL OPERATION | |
| TEMPERATURE ADJUSTMENT (80°F-104°F/26°C-40°C) | 12 |
| JETS OPERATION | 12 |
| ADJUSTING PRESET FILTER CYCLES..... | 13 |
| OPERATIONAL MODES..... | 13 |
| SMART WINTER MODE..... | 13 |
| DIAGNOSTIC LCD MESSAGE | 14 |
| COMPONENT OPERATION | |
| SPA COMPONENT OPERATION | 15 |
| FILL UP AND START-UP INSTRUCTIONS | |
| FILLING THE SPA WITH WATER | 16 |
| APPLYING POWER | 16 |
| ADDING START-UP CHEMICALS | |
| WATER CHEMISTRY GUIDELINES..... | 17 |
| SPA MAINTENANCE | |
| FILTER CARTRIDGE MAINTENANCE | 18 |
| SURFACE CARE..... | 19 |
| COVER CARE | 19 |
| CABINET CARE | 19 |
| SPA LED LIGHT REPLACEMENT | 19 |
| DRAINING OR WINTERIZING | |
| DRAINING YOUR SPA | 20 |
| WINTERIZING YOUR SPA..... | 20 |
| TROUBLESHOOTING PROCEDURES | |
| NO COMPONENT OPERATION..... | 21 |
| PUMP DOES NOT OPERATE, BUT THE LIGHT DOES | 21 |
| POOR JET ACTION..... | 21 |
| WATER IS TOO HOT..... | 21 |
| REPLACEMENT PARTS | |
| REPLACEMENT SPA PARTS | 22 |

SAFETY INFORMATION

IMPORTANT SAFETY INSTRUCTIONS

READ AND FOLLOW ALL INSTRUCTIONS

AVOIDING THE RISK TO CHILDREN

DANGER:

- **RISK OF CHILD DROWNING.** Extreme caution must be exercised to prevent unauthorized access by children. To avoid accidents, ensure that children cannot use a spa unless they are supervised at all times.

WARNING:

- To reduce the risk of injury, do not permit children to use this product unless they are closely supervised at all times.
- To reduce the risk of injury, lower water temperatures are recommended for young children. Children are especially sensitive to hot water.

DO:

- Make sure you always lock the child resistant locks after using the spa for your children's safety. Every spa is equipped with a locking cover that meets the ASTM F1346-91 Standard for Safety Covers.
- Test the water temperature with your hand before allowing your child to enter the spa to be sure that it's comfortable. Children are especially sensitive to hot water.
- Remind children that wet surfaces can be very slippery. Make sure that the children are careful when entering or exiting the spa.

DON'T:

- Allow children to climb onto the spa cover.
- Allow children to have unsupervised access to the spa.

AVOIDING THE RISK OF ELECTROCUTION

Risk of electrocution

- Connect only to a grounded source.
- Do not bury the power cord. A buried power cord may result in death or serious personal injury due to electrocution if direct burial-type cable is not used, or if improper digging occurs.
- A ground terminal (pressure wire connector) is provided on the control box inside the unit to permit connection of a minimum No. 10 AWG solid copper bonding conductor between this point and any metal equipment, metal water pipe, metal enclosures of electrical equipment, or conduit within five feet (1.5 m) of the unit as needed to comply with local requirements.

WARNING:

- To reduce the risk of electrical shock, replace a damaged cord immediately. Failure to do so may result in death or serious personal injury due to electrocution.
- Your spa is provided with a Ground Fault Circuit Interrupter for user and equipment protection. To ensure proper operation of this important safety device, test according to the following instructions per electrical configuration.

SAFETY INFORMATION

110 VOLT CORD-CONNECTED 15 AMP MODELS:

- The GFCI is located at the end of the power cord. Before each use, with the unit operating, push the TEST button. The unit should stop operating and the GFCI power indicator will go out. Wait 30 seconds and then reset the GFCI by pushing the RESET button. The GFCI power indicator will turn on, restoring power to the spa. If the interrupter does not perform in this manner, there may be an electrical malfunction and with it, the possibility of an electric shock. Disconnect the power until the problem has been corrected. **NOTE: This will reset the filter cycle.**

230 VOLT, PERMANENTLY INSTALLED MODELS:

- A ground terminal is provided on the control box. To reduce the risk of electric shock, connect this terminal to the grounding terminal of your electrical service or subpanel with a continuous green, insulated copper wire. The wire must be equivalent in size to the circuit conductors supplying the equipment. In addition, a bonding terminal (pressure wire connector) is provided on the outside of the control box for bonding to local ground points. To reduce the risk of electric shock, this connector should be bonded with a No. 8 AWG (8.4 mm²) solid copper wire to any metal ladders, water pipes, or other metal within 5 feet (1.5 m) of the spa to comply with local requirements. The means of disconnection must be readily accessible, but must be installed at least 5 feet (1.5 m) from the spa.
- Your spa requires a suitably rated circuit breaker to open all ungrounded supply conductors.
- Your spa must have a ground fault circuit interrupter in an electrical subpanel. Before each use of the spa and with the unit operating, push the TEST button on the breaker. The switch should click over to the “Trip” position. Wait 30 seconds and reset the GFCI breaker by switching it completely off and then completely on. The switch should then stay on. If the interrupter does not perform in this manner, it is an indication of an electrical malfunction and the possibility of an electric shock. Disconnect the power until the fault has been identified and corrected.

IMPORTANT: Failure to wait 30 seconds before resetting the GFCI may cause the spa’s Power Indicator (on the control panel) to blink. If this occurs, repeat the GFCI test procedure.

DANGER: RISK OF ELECTRICAL SHOCK

- Install spa at least 5 feet (1.5 m) from all metal surfaces. A spa may be installed within 5 feet of a metal surface if each metal surface is permanently connected by a minimum No. 10 AWG solid copper conductor attached to the wire ground connector on the terminal box that is provided for this purpose if in accordance with National Electrical Code ANSI/NMFA70-1993.
- Do not permit any electrical appliances, such as a light, telephone, radio, or television within 5 feet (1.5 m) of a spa. Failure to maintain a safe distance may result in death or serious personal injury due to electrocution if the appliance should fall into the spa.
- Install your spa in such a way that drainage is away from the electrical compartment and from all electrical components.

DO:

- Be sure your spa is connected to the power supply correctly - use a licensed electrical contractor.
- Disconnect the spa from the power supply before draining the spa or servicing the electrical components.
- Test the Ground Fault Circuit Interrupter(s) before each use.

DON'T:

- Use the spa with the equipment compartment door removed.

SAFETY INFORMATION

- Place electrical appliances within 5 feet (1.5m) of the spa.
- Use an extension cord to connect the spa to its power source. The cord may not be properly grounded and the connection is a shock hazard. An extension cord may cause a voltage drop, which will cause overheating of the jet pump motor and motor damage.
- Attempt to open the electrical control box. There are no user serviceable parts inside.

RISKS TO AVOID

DANGER: RISK OF INJURY

- DO NOT sit in the filter compartment area. Sitting in this area can cause:
a) Restriction of Filter Pump suction/vacuum b) Damage to components
- Both can result in bodily harm. Should damage occur to components in this area, replace immediately!

To reduce the risk of injury to persons, DO NOT remove floating weir, basket, and filter located in the filter compartment while the spa is running.

- The suction fittings in the spa are sized to match the specific water flow created by the pump. Never replace a suction fitting with one rated less than the flow rate marked on the original suction fitting.
- There is a danger of slipping and falling. Remember that wet surfaces can be very slippery. Take care when entering or exiting the spa.
- Never operate spa if the suction fittings are broken or missing.
- People with infectious diseases should not use the spa.
- Keep any loose articles of clothing or hanging jewelry away from rotating jets or other moving components.

Increased side effects of medication

- The use of drugs, alcohol or medication before or during spa use may lead to unconsciousness with the possibility of drowning.
- Persons using medications should consult a physician before using a spa; some medication may cause a user to become drowsy, while other medication may affect heart rate, blood pressure, and circulation.
- Persons taking medications which induce drowsiness, such as tranquilizers, antihistamines or anticoagulants should not use the spa.

Health problems affected by spa use

- Pregnant women should consult a physician before using spa.
- Persons suffering from obesity or with a medical history of heart disease, low or high blood pressure, circulatory system problems, or diabetes should consult a physician before using spa.

Unclean water

- Keep the water clean and sanitized with correct chemical care. The recommended levels for your spa are:
Free Available Chlorine (FAC): 3.0-5.0 ppm Total Alkalinity: 80 - 120 ppm
Water pH: 7.2 - 7.8 Calcium Hardness: 100- 250 ppm

IMPORTANT: Turn jet pump on for at least ten minutes after adding ANY spa water chemicals into the filter compartment.

- Clean the filter cartridge monthly to remove debris and mineral buildup which may affect the performance of the hydromassage jets, limit the flow, or trip the high-limit thermostat which will turn off the entire spa.

SAFETY INFORMATION

AVOIDING THE RISK OF HYPERTHERMIA

Prolonged immersion in hot water can result in HYPERTHERMIA, a dangerous condition which occurs when the internal temperature of the body reaches a level above normal (98.6°F, 37°C). The symptoms of hyperthermia include unawareness of impending hazard, failure to perceive heat, failure to recognize the need to exit the spa, physical inability to exit the spa, fetal damage in pregnant women, and unconsciousness resulting in a danger of drowning.

⚠ WARNING:

The use of alcohol, drugs, or medication can greatly increase the risk of fatal hyperthermia in hot tubs and spas.

TO REDUCE THE RISK OF INJURY:

- The water in the spa should never exceed 104°F (40°C). Water temperatures between 100°F (38°C) and 104°F (40°C) are considered safe for a healthy adult. Lower water temperatures are recommended for extended use (exceeding 10 minutes) and for young children. Extended use can cause hyperthermia.
- Pregnant or possibly pregnant women should limit spa water temperatures to 100°F (38°C). Failure to do so may result in permanent injury to your baby.
- Do not use spa immediately following strenuous exercise.

AVOIDING THE RISK OF SKIN BURNS:

- To reduce the risk of injury, before entering a spa the user should measure the water temperature with an accurate thermometer.
- Test the water with your hand before entering the spa to be sure it's comfortable.

SAFETY SIGN

A SAFETY SIGN in the owner's package. The sign, which is required as a condition of Product Listing, should be permanently installed where it is visible to the users of the spa.

IMPORTANT SPA INSTRUCTIONS

The following contains important spa information, and we strongly encourage you to read and apply them.

DO:

- Use and lock the vinyl cover when the spa is not in use, whether it is empty or full.
- Follow the Spa Care and Maintenance recommendations stated in this manual.
- Use only approved accessories and recommended spa chemicals and cleaners.

DON'T:

- Leave the spa exposed to the sun without water or the vinyl cover in place. Exposure to direct sunlight can cause solar distress of the shell material.
- Roll or slide the spa on its side. This will damage the siding.
- Lift or drag the cover by using the cover lock straps; always lift or carry the cover by using the handles.
- Attempt to open the electrical control box. There are no user serviceable parts inside. Opening of the control box by the spa owner will void the warranty. If you have an operational problem, carefully go through the steps outlined in the Troubleshooting section. If you are not able to resolve the problem, contact your authorized dealer. Many problems can easily be diagnosed over the telephone by an Authorized Service Technician.

INSTALLATION

PLANNING A LOCATION FOR YOUR SPA

Consider these things when determining where to place your spa.

SAFETY FIRST:

Make sure your spa is positioned so access to the equipment compartment and side panels will not be blocked. Be certain your installation will meet all city and local safety codes and requirements.

PLANNED USE OF SPA:

How you intend to use your spa will help you determine where you should position the spa. For example, will you use it more for recreational or therapeutic purposes? If your spa is mainly for family recreation, leave plenty of room around it for activity and lawn furniture. If you will use it more for relaxation and therapy, you'll probably want to create privacy mood around the spa.

PRIVACY:

Think of your surroundings during all seasons to determine your best privacy options. Consider the view of your neighbors when you plan the location of your spa.

VIEWS:

Think about the direction you will be facing when sitting in your spa. Do you have a special landscape you will find enjoyable? Perhaps there is an area that has a soothing breeze during the day or a lovely sunset in the evening.

ENVIRONMENT:

If you live in a climate with a snowy winter and hot summer, a place to change clothes or a house entry near the spa is convenient. A warmer climate may require shade from the hot sun. Consider placement of trees, shrubs, patio cover or perhaps a gazebo structure to provide what you will need. Indoor installations require adequate ventilation. When the spa is in use, considerable amounts of moisture are produced. This moisture can damage walls and ceiling surfaces over time. Special paint is available to resist moisture damage. Remember that spas periodically require drainage, so plan your environment accordingly.

KEEP CLEAN:

Prevent dirt and foliage from being tracked into your spa by utilizing concrete for paths and access areas. Check the location of spill paths from gutters, trees, and shrubs.

SERVICE ACCESS:

Many people choose to install tile or custom wood around their spas. If you are installing your tub with custom decorative trimming, remember to allow for access to it for service. Should you need service, a technician may need to remove the tub's door panel, or access it from beneath. It is always best to design special installations so the spa can still be moved, or lifted from the ground.

A GOOD FOUNDATION

Your new spa needs a good solid foundation. The area your spa sits on must be able to support the spa, the water in it and those who use it. If the foundation is inadequate, it may shift or settle after the spa is in place, causing stress to the shell or components.

INSTALLATION

BE AWARE:

Damage caused by inadequate or improper foundation support is not covered by the spa warranty. It is the sole responsibility of the spa owner to provide a proper foundation for the spa.

Make sure the foundation where the spa is placed drains water away from the spa. Proper drainage will keep components dry from rain and wet weather.

Your spa weight must always be considered when installing your spa. If you are installing it on an elevated wood deck or other structure, it is advisable to consult a structural engineer or contractor to ensure the structure will support the weight.

IT IS STRONGLY RECOMMENDED THAT A QUALIFIED, LICENSED CONTRACTOR PREPARE THE FOUNDATION FOR YOUR SPA.

A reinforced concrete pad at least four inches thick is recommended for your spa. The reinforcing rod or mesh in the pad should be attached to a bond wire.

INDOOR INSTALLATION:

Be aware of some special requirements if you place your spa indoors. Water will accumulate around the spa, so flooring materials must provide a good grip when wet. Proper drainage is essential to prevent a build-up of water around the spa. When building a new room for the spa, it is recommended that a floor drain be installed. The humidity will naturally increase with the spa installed. Water may get into woodwork and produce dryrot, mildew, or other problems. Check for airborne moisture's effects on exposed wood, paper, etc. in the room. To minimize these effects, it is best to provide plenty of ventilation to the spa area. An architect can help to determine if more ventilation must be installed.

PLACING THE SPA

CHECK THE DIMENSIONS OF YOUR SPA:

Compare the spa dimensions to the width of gates, sidewalks, and doorways along the delivery route used to bring the spa into your yard. It may be necessary for you to remove a gate or partially remove a fence in order to provide an unobstructed passageway to the installation location. Also, keep in mind—if you are using special equipment to place your spa into an area it will be necessary to include those measurements and weights.

PLANNING A DELIVERY ROUTE:

Check the width of gates, doors and sidewalks to make sure your spa will pass through unobstructed. You may have to remove a gate or part of a fence to allow for adequate width clearance. If the delivery route will require a 90-degree turn, check the measurements at the turn to ensure the spa will fit. Check for protruding gas meters, water meters, A/C units, etc., on your home which will cause obstructions along the delivery path to your yard. Check for low roof eaves, over hanging branches or rain gutters that could be an obstruction to overhead clearances.

SPECIAL CIRCUMSTANCES:

The use of a crane for delivery and installation is primarily to avoid injury to your spa, your property or to delivery personnel. Our customer service may be able to assist you with the arrangements. Cranes are not considered "normal delivery".

EQUIPMENT ACCESS

EQUIPMENT ACCESS PANEL

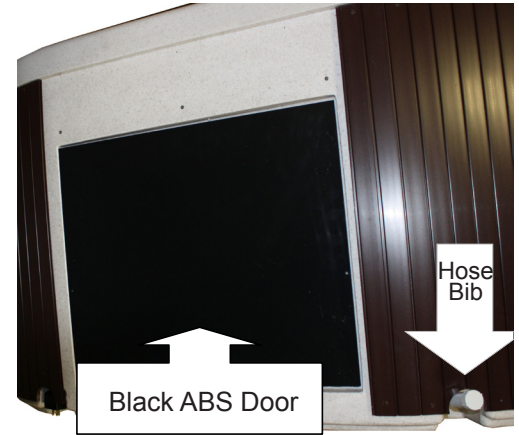
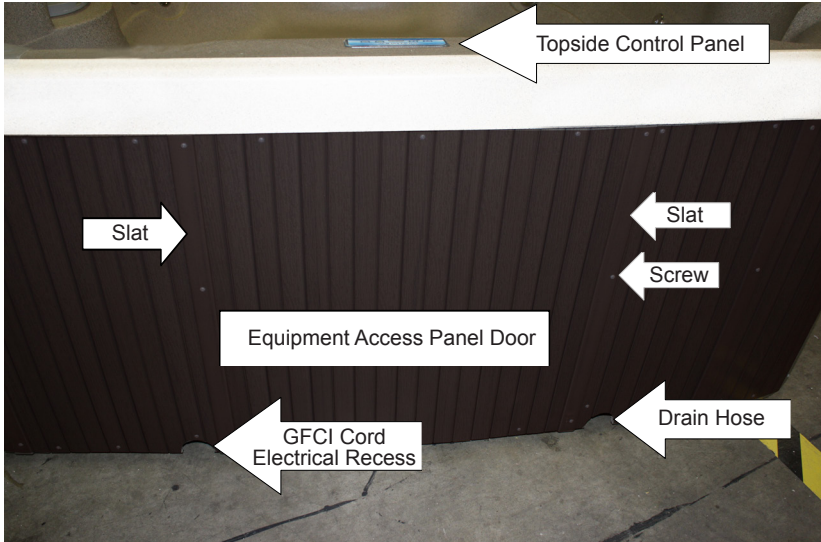

To access the equipment compartment:

- Remove 1 vertical slat and 3 screws on each side of Equipment Access Panel Door.
- Remove 6 screws from Equipment Access Panel Door to remove door.
- Remove screws from Black ABS Door (if your spa has vertical slats) to access Equipment Compartment.

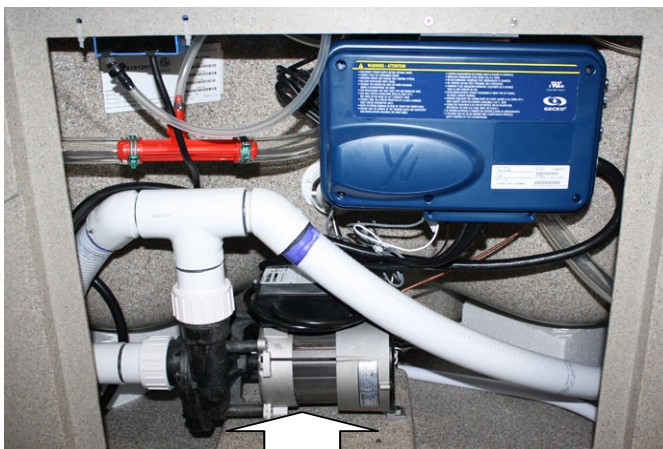

ELECTRICAL REQUIREMENTS

ELECTRICAL

⚠ DO NOT PLUG IN YOUR SPA WITHOUT FIRST FILLING WITH WATER!

⚠ DANGER – RISK OF ELECTRIC SHOCK

Installations that do not conform to the following procedures and requirements may expose users to electric shock. Non-conforming installations will not be covered under warranty.

Your electrical outlet must have been installed by an electrical contractor and been approved by a local building electrical inspection authority.

110V ELECTRICAL

1. Power supply installation must include a 15 amp dedicated, grounded wall outlet.
2. The outlet should not be shared with any other appliance. It must be labeled and easily accessible to users.
3. DO NOT use extension cords of any kind this will invalidate your warranty.
4. For your safety, if you are having an electrician install an electric outlet for the spa it should be no closer than 5 feet (152.4cm) and no further than 10 feet (304.8cm) from the spa. [Reference National Electrical Code 680 - 6a(1) and 680 - 41a.]

Note: If the manufacturer installed GFI Cord is damaged, the GFI Cord must be replaced by authorized service personnel.

230V ELECTRICAL

1. Installations within 5 feet of any metal surfaces must ground the metal surfaces to the hot tub. Use an 8 AWG solid copper wire and attach it to the grounding lug on the power pack, located in the equipment compartment.
2. Only a licensed electrician may install power to the spa.
3. Power supply installation must include a suitably rated ground fault circuit interrupter (GFCI) as required by NEC Article 680-42. The circuit breaker must be dedicated and should not be shared with any other appliances. It must be labeled and easily accessible to users.
4. The electrical supply for the spa must include a suitable rated switch or circuit breaker to open all ungrounded supply conductors to comply with Section 422-20 of the National Electric Code, ANSI/NFPA 70. The disconnecting means must be readily accessible to the spa's occupant but installed at least 5 feet from the spa water.
5. Power supply lines must be hard wired into the power pack. DO NOT use extension or plug-type cords of any kind. The use of a shut-off box near the hot tub is also recommended. This box provides a quick and convenient method to shut off power to the hot tub for emergencies and maintenance.
6. Supply lines must be properly sized as per the NEC (National Electric Code). A ground line must be provided that is as large as the largest current carrying conductor, but no less than 8 AWG. All wiring must be copper to ensure adequate connections. Do not use aluminum wire.
7. Please open the front cover of the control box, and follow the instructions and wiring diagram printed on the backside.

ELECTRICAL REQUIREMENTS

8. CAUTION, 230V POWERED SPAS – These spas must be hard wired to your household electrical service box only. Do not use an extension cord or any other disconnect-able power cord. The use of an extension cord or a disconnect-able power cord is highly dangerous and will void all warranties!
- Wire size must be appropriate per NEC and/or local codes.
 - Wire size is determined by length of run from breaker box to spa and maximum current draw.
 - THHN copper core wire only.
 - All wiring must be copper to ensure adequate connections. Do not use aluminum wire.

⚠ CAUTION! WARNING! SHOCK HAZARD! No User Serviceable Parts.

Do not attempt to service any electronic component. Contact Customer Service or a reputable spa service company for assistance. Follow all owners' manual power connection instructions. Service must be performed by a licensed electrician and all grounding connections must be properly installed.

Equipment access is below the Topside Control Panel on Plug & Play LifeSmart Spas.



Equipment access is below the Topside Control Panel on 230 Volt LifeSmart Spas.



ELECTRICAL REQUIREMENTS

CONFIGURING SYSTEM

110 VOLT INSTALLATION (CORD CONNECTED)

Most Spas come with a factory-installed power supply GFCI cord and are to be plugged into a grounded type 110 volt, 15 ampere receptacle. No other electrical appliance or fixture can be used on this circuit.

IMPORTANT: Under **NO** circumstances should an extension cord be used. Use of an extension cord will seriously degrade the performance of the equipment and can create an electrical hazard.

230 VOLT INSTALLATION (PERMANENTLY CONNECTED)

The Coronado requires a 230 volts 32 amp service (2 hot wires, a neutral wire, and a ground wire). When the spa is powered up, the heater will provide approximately 4000 watts of heat when the pump is operating in LOW or HIGH speed and the thermostat is calling for heat.

All electrical connections must be made in accordance with the wiring information contained on the electrical control box cover and the National Electrical Code.

230V Permanently Connected Control Box

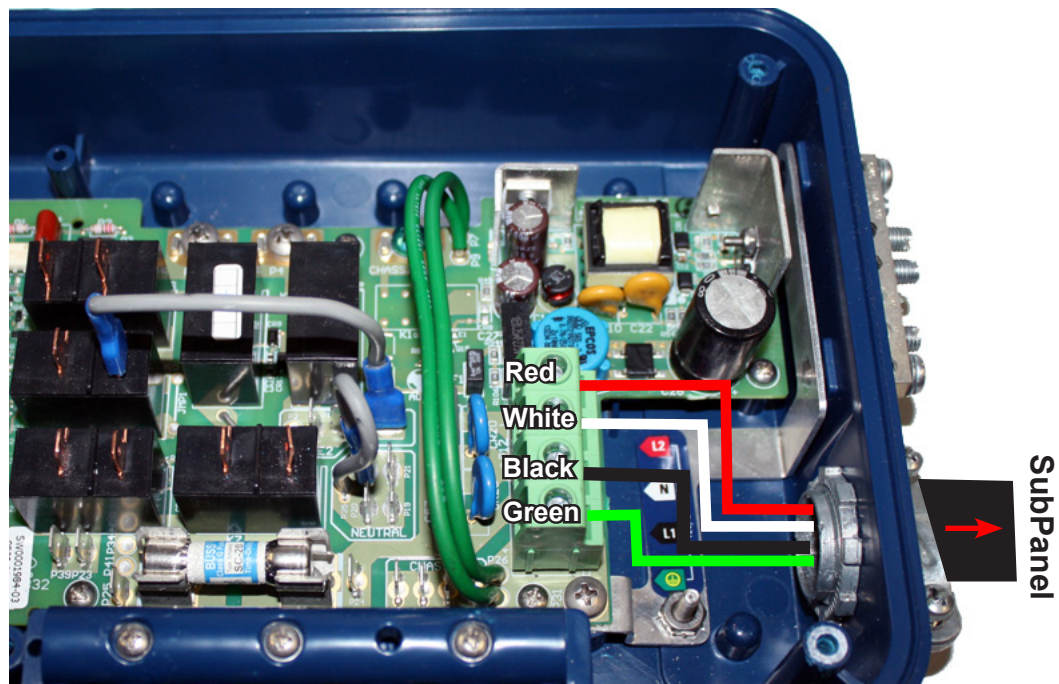

Install Red, White, Black and Green #8 wires to the control box terminal block and connect to a 40 amp Subpanel with a dedicated GFCI circuit breaker.

ELECTRICAL REQUIREMENTS

ELECTRICAL WIRING DIAGRAM FOR 230V USE

It is recommended that a licensed electrician install the power to your spa in accordance with the National Electric Code and/or any local electrical codes in effect at the time of installation.

Power supply installation must include a properly rated GFCI circuit breaker. The circuit must be dedicated and should not be shared with any other appliances. The power supply must be hard wired into the power pack.

230V Wiring Instructions:

4 wires/Minimum 40 amp GFCI Breaker #8 AWG 75°C Copper Wire Minimum (less than 100' length) Copper wire only.

Special Note:

If the GFCI Breaker trips immediately after attempting to turn on, please check the White Neutral Wire that is connected to the Spa.

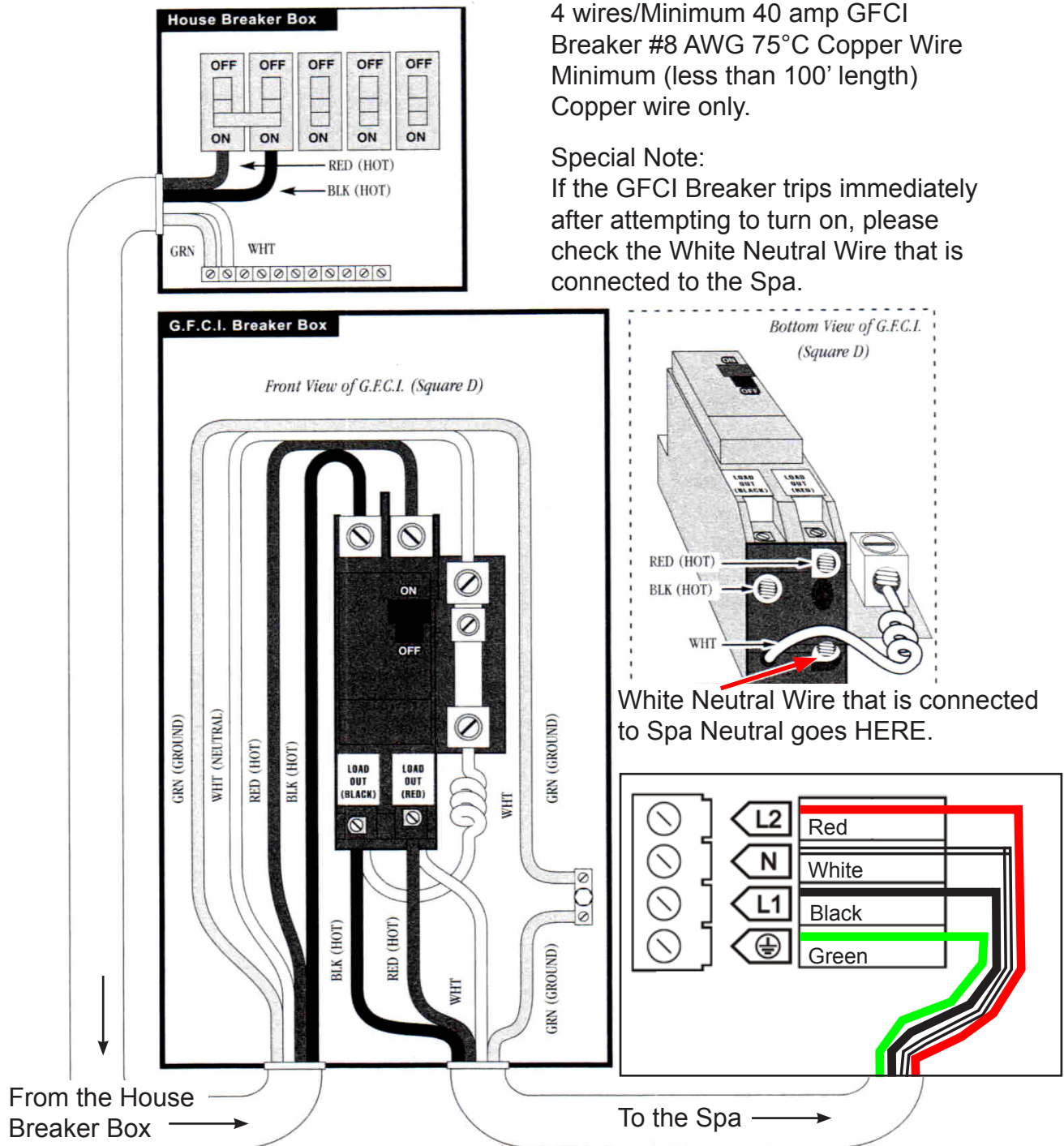

CONTROL PANEL OPERATION

INITIAL START-UP - When the spa is first powered up the control system begins a 2 minute Startup Mode. Different codes will display on the screen. Once Startup Mode completes, the actual temperature is displayed on the screen, and the spa will then begin to heat and maintain the water temperature and the first filter cycle will start. Your spa has been designed so that it will automatically heat the water to the factory set temperature of 100°F unless you set the spa to a different temperature. If power is disconnected from the spa, it will automatically revert back to the last saved set temperature when power is reapplied.

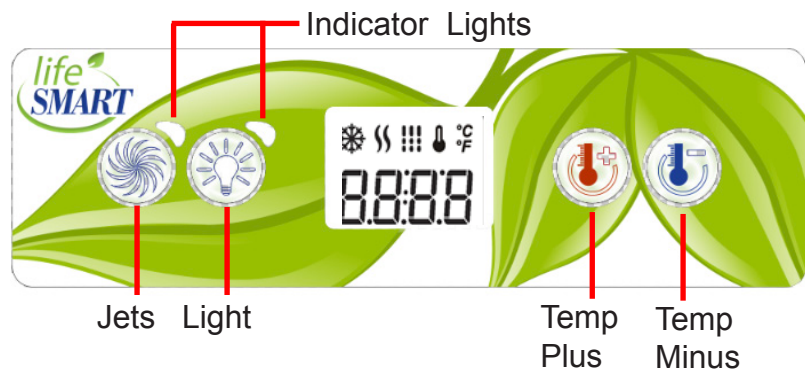

TEMPERATURE ADJUSTMENT (80°F-104°F/26°C-40°C)

The temperature can only function between 80°F - 104°F / 26°C - 40°C. The last measured temperature will constantly display on LCD.

Press the *Plus* or *Minus* buttons to display the set temperature and indicator 🌡. Each time either button is pressed again, the set temperature will increase or decrease depending on which button is pressed. After five seconds, the LCD will automatically display the current spa temperature.

The “heater” indicator 🔥 lights up when the heater is on. It flashes when there is a request for more heat, but the heater is not on. Once set temperature is reached the indicator 🔥 shuts off and the low speed of the jet pump turns off after 30 seconds (if not in filter cycle).

JETS OPERATION

For **CORONADO** model, firmly press the *Jets* button once to activate the low speed of the pump and again for the high speed. Firmly press the *Jets* button again to turn off the pump. If left running the low or high speed pump will automatically turn off after 1 hour. The "Jets" indicator light next to the button will blink when jet pump is on low speed and is solid on high speed. For all other models, press the *Jets* button once to turn on the pump and a second time to turn off the pump.

MULTI COLOR LED LIGHT

Press the *Light* button once to turn on the light, the light indicator next to the button is lit when the light is on. Press the button again to turn the light off. Every time the light is quickly turned off and on a new light mode will appear. The sequence is as follows: White, Slow Full color wheel, Amber, Blue, Red, Green, Purple, Blue/Green color wheel, Red/Green color wheel and Fast Full color wheel. The last light mode used will come back on when the light is turned off for more than 2 seconds.

NOTE: If left on, the light will automatically turn off after 4 hours of operation.

FILTER CYCLES !!!

There are two filter cycles: the first cycle (F1) starts right after power up and the second cycle (F2) will start 12 hours later. The default duration for the first filter cycle is 1 hour, and 30 minutes for the second cycle. Filter cycles (on Coronado model) only run at low speed. The “Filter” indicator !!! lights up when a filter cycle is on. The duration of each filter cycle can be modified.

CONTROL PANEL OPERATION

ADJUSTING PRESET FILTER CYCLES

Filter duration is programmable between 0 and 6 hours in 30 minute increments (0.5 hours) for both filter cycles. To program the cycle times:

1. Press and hold *Light* button for 5 seconds until F1 is displayed.
2. Press the *Plus* or *Minus* button to adjust the cycle time for F1.
3. Press the *Light* button to store the F1 cycle and move to the F2 cycle.
4. Press the *Plus* or *Minus* button to adjust the cycle time for F2.
5. Wait 15 seconds to allow the exit timer to expire and store the setting.

IMPORTANT: To reset the first filter cycle start time, skip step 5 and continue pressing the *Light* button until the actual temperature is displayed. Powering down of the spa will also reset the first filter start time.

FILTER CYCLE SUSPENSION: The filter cycle will be suspended every time a jet pump or light is activated manually during the filter cycle time. The suspension will end 10 minutes after the completion of the manual use.

OPERATIONAL MODES

The Standard Mode is the default operational mode preset from the factory.

STANDARD MODE: Is programmed to maintain the desired temperature.

ECONOMY MODE (CORONADO MODEL ONLY): The spa will heat normally during the filter cycle; outside of the filter cycle, the set point will be lowered by 20°F. To enter the programming screen and toggle between Standard and Economy Mode the following is required:

1. Press and hold the *Light* button for 5 seconds
2. Press the *Light* button several times until EP 0 or EP 1 is displayed.
3. Use the *Plus* or *Minus* button to choose between Standard and Economy Mode.
EP 0 = Standard Mode and EP 1 = Economy Mode.
4. Wait 15 seconds to allow the exit timer to expire and store the setting.

OFF MODE: This mode allows you to stop all spa functions for 30 minutes to perform quick spa maintenance. To place the spa in OFF MODE, press and hold the Jets button for 5 seconds. The display will toggle between OFF and water temperature when in the OFF MODE. To stop the OFF MODE before the 30 minute cycle time is complete, simply tap (short press) the Jet button.

FAHRENHEIT/CELSIUS SETTING

To Change water temperature display to either Fahrenheit or Celsius, press and hold *Light* button for 5 seconds until F1... is displayed. Press the *Light* button several times until F or C  is displayed. Press the *Plus* or *Minus* button to change. Wait 15 seconds to allow the exit timer to expire and store the setting.

SMART WINTER MODE

The Smart Winter Mode is used to prevent water from freezing in the plumbing of the spa. As soon as there is a risk of freezing, this protection kicks in. The SWM protection will turn back off only after 24 hours without a risk of freezing. During this 24 hour period, the Smart Winter Mode icon remains on; the icon blinks when the purge is active.

CONTROL PANEL OPERATION

DIAGNOSTIC LCD MESSAGE

| Message | Meaning | Action Required |
|---------|---|---|
| | No message on display. Power has been cut off to the spa. | The control panel will be disabled until power returns. Spa settings will be preserved until next power up. |
| HL | The system has shut the heater off because the temperature at the heater has reached 122°F (50°C). Do not enter the water! | DO NOT ENTER THE WATER. Remove the spa cover and allow the water to cool down, then shut power off and power your spa up again to reset the system. If spa does not reset, shut off the power to the spa and call Customer Service. |
| AOH | Temperature inside the equipment compartment is too high 194F (90°C), causing the internal temperature in the control system to increase above normal limits. | Open equipment compartment and wait until error clears. |
| PRR | A problem is detected with the temperature probe. | Call your dealer or service supplier. |
| OH | The water temperature in the spa has reached 108°F (42°C). Do not enter the water! | Remove the spa cover and allow the water to cool down to a lower temperature. Call your dealer or service supplier if problem persists. |
| UPL | No low level configuration software has been installed into the system. | Call your dealer or service supplier. |
| FLO | No water flow is detected by the control system but flow is expected. | Make sure that the jet pump is running and water is flowing; check and clean filters; make sure water valves are open; make sure spa has a proper water level. If problem persists, call your dealer or service supplier. |

 Warning! Shock Hazard! No User Serviceable Parts.

Do not attempt service of the control box. Contact Customer Service for assistance. Follow all owner manual power connection instructions. Installation must be performed by a licensed electrician and all grounding connections must be properly installed.

 WARNING! DO NOT ENTER SPA IF WATER IS TOO HOT

Water is too hot. Overheat protection heater is deactivated. Spa water temperature is above acceptable limits. When the actual water temperature is approximately 2° F (1° C) above the set temperature, the jet pump will stop operating to reduce (frictional) heating. If the spa water temperature continues to rise and gets above 108° F (42°C), the spa will go into an “OH” overheat condition.

COMPONENT OPERATION

SPA COMPONENT OPERATION

AIR CONTROL VALVE

The air control valve serves to regulate the amount of air mixed with the water when the jets are operational. Rotate the air control in one direction to achieve the maximum jet pressure and therapeutic action. Rotating the air control in the opposite direction to turn air off and allow the jets to work with water only. Turn the air controls off when the spa is not in use, this will prevent cold air from entering the spa and will keep heating cost to a minimum. The ozone generator infusion jet, will always produce air bubbles.

HYDROTHERAPY JETS

The hydrotherapy jets are recessed in the wall of the spa. Rotate the jet face counterclockwise to turn the jets on, clockwise to turn the jets off. Not all jets have a rotational face to turn off and on the jets. Turning a jet on or off will increase or decrease the effects of any jets “not” in the closed position.

OZONE GENERATOR

The ozone system greatly enhances the quality of the spa water when used to supplement the spa owner’s regular water maintenance program. Contrary to some information circulated throughout the pool and spa industry regarding ozone systems, ozone **CAN NOT** be used as a single-source sanitizer, water clarifier, anti-foamer, and mineral chelating agent. A secondary source sanitizer must be used to maintain 2.0 ppm (2.0 mg/L) of Free Available Chlorine (FAC). Watkins Manufacturing Corporation recommends that a chemical maintenance program based on recognized and documented industry standards still be followed when using an ozone purification system to assure water sanitation and the highest quality purified water.

WATERFALL

If your spa has a waterfall, there will also be a control valve to operate the amount of flow through the waterfall from no flow to a steady stream. This valve will be located in various positions on the spa depending on the model.

Note: The air control valve and the waterfall flow valve may look exactly the same, however; they are separate components.

Never run your spa without the filter in place as this helps to prevent foreign objects from entering your system. Any clogging in system due to foreign objects will not be covered under warranty.

FILL UP AND START-UP INSTRUCTIONS

The following procedures should be followed on initial startup and whenever the spa is drained for routine maintenance.

FILLING THE SPA WITH WATER

1. Clear all the debris from your spa.
2. Be sure to open all jets to allow as much air as possible to escape from the plumbing during the filling process.
3. Use a garden hose to fill your spa with water.

NOTE: Do not use hot or softened water.

4. As the water level rises, check inside the equipment compartment for water leaks. It may be necessary to tighten unions and/or fittings that may have loosened during delivery. There is no need to call for service; this can easily be done by you. If assistance is required, contact a customer service representative at (888) 961-7727
5. Under normal circumstances keep the water level half way between the top of the spa and grey filter ring or just above the highest jets (whichever is higher). Keep in mind that every person who enters the spa will create a certain amount of water displacement, depending on their size and weight; as a result you may need to reduce the amount of water you normally have in the spa. To prevent the water from hitting your topside control or flowing over the top edge of the spa. Additionally, failure to keep enough water in your spa may result in damage to your system & invalidate your warranty. If your spa filter is sucking in air causing the pump to cavitate, you need to add water!
6. Check the filter installation and make sure the filter is not loose.

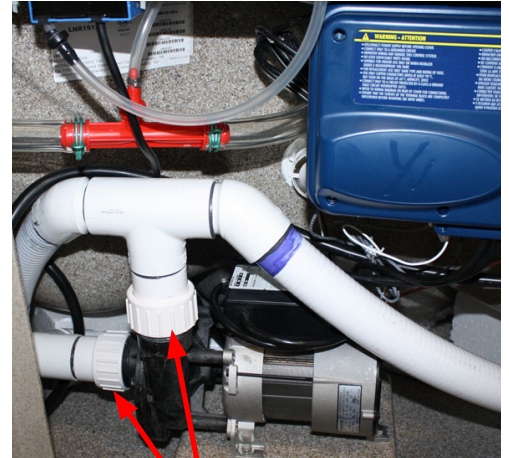

UNIONS

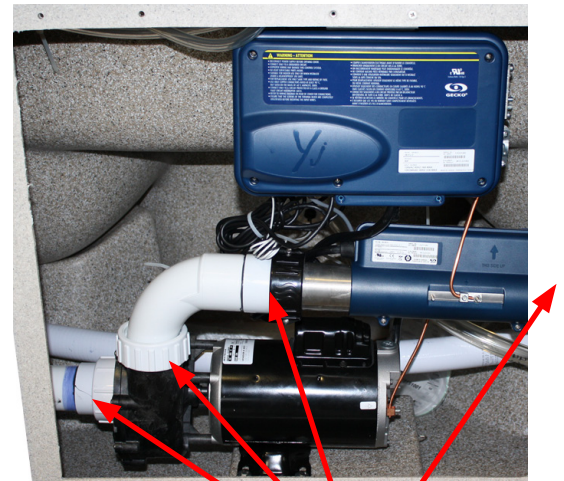

UNIONS

APPLYING POWER

1. Plug the spa into the 15 amp dedicated, grounded wall outlet, or turn on power from Main Panel and 230V Sub Panel.
2. Press the Jets button on the topside control panel to activate the spa. Rotate all the air control valves counterclockwise and observe the increased jet action.
3. While the pump is running, leaks may have occurred during transit. Check again for water leaks at the drain spigot, unions, or fittings in the equipment compartment. If water is leaking from one of these areas, there is no need to call for service. Simply tighten the fitting. If assistance is required, call a customer service representative at (888) 961-7727.
4. After checking your spa for leaks it is now time to adjust your spa settings. Press the "Up" or "Down" button on your topside control panel until the display indicates your desired temperature is set.

ADDING START-UP CHEMICALS

WATER CHEMISTRY GUIDELINES

The following step-by-step instructions are a recommended guideline for balancing water chemistry. If unsure about any step in the process, please contact a Customer Care Associate at (888) 961-7727) or by email at ahsservice@watkinsmfg.com.

Initially, it is advisable to identify what minerals (e.g. iron) are present in the local source water. This will provide a better understanding of how to treat the water. Please follow the four steps below and be sure to achieve the correct levels in each area before moving onto the next step.

STEP #1: ESTABLISH PROPER PH LEVEL:

The recommended range for pH is between 7.2 and 7.8. If the reading is too high, lower the pH by using a pH Down/Decreaser (sodium bisulfate). If the pH level needs to be increased, do so with a pH Up/Incraser (sodium hydrogen carbonate). Any pH Up or Down should be added one teaspoon at a time, waiting one-half hour between application and re-measuring.

STEP #2: MEASURE TOTAL ALKALINITY:

The ideal range is between 80-120 parts per million (PPM). If the total alkalinity is too high, it should be reduced by using an Alkalinity Down/Decreaser (sodium bisulfate). If the total alkalinity is too low, it can be increased by adding an Alkalinity UP/Incraser (sodium bicarbonate or sodium hydrogen carbonate). These products should be added in small amounts – a teaspoon at a time. After adding one teaspoon, wait one half hour before re-measuring. Once the safe range of total alkalinity is established, proceed to the next step.

STEP #3: DETERMINE CALCIUM HARDNESS:

It is important to bring the calcium reading to between 100-250 PPM. If the reading requires adjustment, it should now be corrected. If the water is too soft (a low reading) calcium hardness should be added to the water to increase the PPM reading. If the water is too hard (a high reading), it can be corrected by either: (A) a mixture of hard and soft water added to attain a reading in the safe range, or (B) addition of stain and scale control. If calcium hardness is a problem with the local source water (either too hard or too soft) a test kit, which measures calcium hardness, is essential.

STEP #4: SANITIZING:

After steps 1-3 are complete, **the spa must be sanitized using Chlorine (sodium dichlor)**. Add 2 teaspoons of Chlorine, and increase as necessary to reach a level of 3-5 ppm. Check and maintain this level weekly, and before and after using the spa. **IMPORTANT NOTE: A granulated sodium dichlor is highly recommended for sanitizing spa water. Never use a sodium trichlor tablet in any form even with a floater. As with any other chemicals, the sanitizer should be introduced to the spa with the jets running a minimum of 10 minutes.**

WEEKLY SHOCK:

Using a potassium monopersulfate (MPS) shock, add approximately 2 oz. spreading it over the water while the jets are running. Shocking is achieved by adding the MPS to turbulent water. Leave the cover up until the jets automatically turn off. The spas are equipped with an automatic time out feature that will shut the jets off after 15 minutes. Then return the cover to the closed position to maintain heat.

IMPORTANT: Damage caused by dirty, clogged, or calcified filters; damage to the spa surface caused by improper use of chemicals to lie on the surface; damage caused by improper pH balance, improper calcium hardness level or other improper water chemistry is not covered under the spa warranty.

SPA MAINTENANCE

FILTER CARTRIDGE MAINTENANCE

Every two weeks, the filter cartridge should be cleaned to remove the objects and particles that have lodged in the cartridge pleats. Using household water pressure and a garden hose with a pressurized nozzle, push water from inside to outside of the pleats, forcing all the trapped particles out.

NOTE: Never run your spa without a filter cartridge!!! This will invalidate your warranty.

NOTE: Filter cartridges should be replaced every six to eight months or earlier when needed. Dirty filters can cause your spa pump to burn out and will invalidate your warranty.

FILTER CARTRIDGE REMOVAL AND CLEANING INSTRUCTIONS

Spa uses a screw in filter cartridge that is easily removed.

- Turn off the power to the spa,
- Push down slightly and turn filter basket counter clockwise to unlock, then pull the basket and weir out.
- Unscrew the filter cartridge counter clockwise and bring it out of the spa (requires many turns).
- Rinse cartridge using a garden hose. Rotate and separate filter pleats while spraying water to remove all dirt and debris possible. Let filter dry and look for calcium deposits (scaling) or an oil film. If you find these, you will need to deep clean your filter cartridge with a “spa filter cleaner” solution to break down and remove unwanted deposits and oils. (For longer filter life you should soak filter in solution regularly.)

CAUTION! Always use proper eye protection when using chemicals, or high-pressure water. Read instructions on cleaning products and follow applicable safety and warning instructions listed on label.

CAUTION! Never scrub the filter cartridge with a brush, as this will cause the filter to wear out and

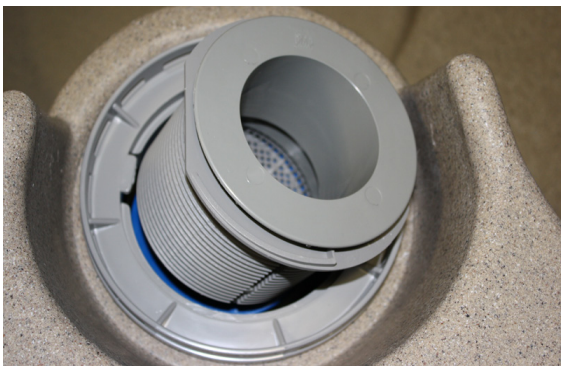

come apart. Never let the spa pump run without a filter cartridge in the skimmer compartment. Running the spa without a filter cartridge may permit debris to enter the spa plumbing and void the warranty!

- Replace filter cartridge, then return basket and weir, insert and rotate clockwise to lock into position. **DO NOT OVERTIGHTEN!**
- Turn spa's power back on.

SPA MAINTENANCE

SURFACE CARE

Do not use solvents or abrasive cleaners to clean the spa. Typically, a mild detergent and water will resolve cleaning issues.

COVER CARE

Please keep your cover free from dirt at all times. Use a cover cleaner or a warm mild soapy water to clean the surface. Do not use any silicone-based products, as it will dry and may eventually crack the vinyl.

NOTE: Do not stand on the cover at any time. Remove the cover when adding chemicals to your spa. This will extend the life of your cover. The gases from burned off chemicals will be trapped under the cover, if not removed. These gases will eat away at the protective lining of the foam inserts. This will not be covered under warranty.

CABINET CARE

Little maintenance is required to keep your spa cabinet looking good. Spa cabinet product should be cleaned as needed to remove dirt and debris.

- NO abrasive or harsh chemicals should be used on your Spa's cabinet.
- NO solvents or cleaners containing aromatic solvents should be used on your spas cabinet.
- Hot Soapy water is the best choice for cleaning your spa's cabinet

AVOID PROLONGED EXPOSURE TO DIRECT SUNLIGHT OR EXCESSIVE TEMPERATURES (100 °F or 38 °C) to avoid your spa cabinet from buckling

SPA LED LIGHT REPLACEMENT

- Turn OFF the power to the spa.
- Remove the equipment compartment access door.
- Locate the rear of the spa light.
- To remove the LED, turn outside housing counter clockwise ¼ turn, and pull out and remove LED from socket.
- Replace the LED by reversing the above steps.



DRAINING OR WINTERIZING

Every three to six months, depending upon the water condition, you need to renew your water.

CAUTION: READ THIS BEFORE DRAINING YOUR SPA

- To prevent damage to the spa's components, unplug the spa from the outlet before draining. **Do not plug your spa back in until your spa has been refilled with water.**
- There are certain precautions to keep in mind when draining your spa. If it is extremely cold, and the spa is outdoors, freezing could occur in the plumbing or the equipment.
- Do not leave the spa's shell (inside surface) exposed to direct sunlight.

DRAINING YOUR SPA

DO NOT PUT SPA INTO STANDBY MODE. MODE DOES NOT APPLY WHEN DRAINING SPA.

- If draining for the first time. Pull the hose bib out a few inches from the spa (located in the recess under the spa, just right and below the equipment access door)
- Unscrew and remove the drain cap.
- Attach hose bib to a garden hose and direct to an appropriate draining area, keeping the hose below the water line.
- After your spa is empty, clean the shell and filter cartridge. See "Spa Maintenance"
- After cleaning, remove garden hose, replace drain cap and push the hose bib back into the recess.
- Follow the "Fill up and Start-up Instructions".



WINTERIZING YOUR SPA

If you plan to store your spa for the winter, you must also use a wet-vac to clean out the water lines to ensure they are free of any water. Water left in the lines might freeze and damage the lines and jets.

1. It will be necessary to remove all water from the interior plumbing.
2. Remove the floating weir, basket, and filter cartridge. Clean the filter cartridge and store in a dry place. Attach the vacuum hose to the **vacuum side** of the shop vac and thoroughly dry the filter compartment.
3. Using the shop vac, remove the water starting with the jets at the top and moving downward. **NOTE:** When removing the water from jet openings, you may notice suction coming from another jet. With the help of a second person, block off any suction from the other jet using a large rag or cloth. This will help pull out the water that is trapped deep inside the main line.
4. Thoroughly dry the spa shell with a clean towel.
5. Using a funnel, pour Propylene glycol anti-freeze into the filter suction fittings and jet outlets. **CAUTION: Use only Propylene glycol as your anti-freeze. This is non-toxic. NEVER use automobile anti-freeze since it is toxic.**
6. Remove the pump drain plug located on the front of the pump housings. Allow all water to drain out. Place the drain plug in a reclosable plastic storage bag and store near the pump. Replace the drain plugs on start-up.
7. Unscrew the suction/discharge pump and heater unions and allow the water to drain. Leave union loose. **NOTE:** Tighten unions before filling spa.
8. Replace the equipment compartment door and secure with screws. **Note:** Damage caused by improper winterizing will not be covered under warranty. You may want to contact a professional for proper winterizing.

TROUBLESHOOTING PROCEDURES

In the event your spa is not working the way it should, please first review all the installation and operating instructions in this manual and check the message on the panel display. If you are still not satisfied it is working properly, please follow the appropriate troubleshooting instructions.

CAUTION! WARNING! SHOCK HAZARD! No User Serviceable Parts.

Do not attempt service of the control box. Contact customer service for assistance. Follow all owner's manual power connection instructions.

NO COMPONENT OPERATION

Check the following:

1. Is there power to the spa?
2. Is the household circuit breaker tripped?
3. Is the GFCI at the end of the spa's power cable tripped?
4. If 1, 2 or 3 are yes contact customer service for service.

PUMP DOES NOT OPERATE, BUT THE LIGHT DOES

Press the JETS button:

The pump operates but no water flows to jets. Pump may not be properly primed. This can happen after the spa is drained and refilled. Press the JETS button several times, never leaving the motor on for more than 5-10 seconds at-a-time.

POOR JET ACTION

1. Press the JETS button to make certain the pump is on.
2. Rotate the air control to the "max" position.
3. Make sure the water level is at least 2" above the gray filter ring.
4. Check for dirty filter. Clean, if necessary.
5. Make sure all jets are in the open position (turn counterclockwise).

WATER IS TOO HOT

1. Check desired temperature on topside control
2. Check for a diagnostic Message (see Control System manual for details)

OH - Overheat (spa is deactivated) **DO NOT ENTER THE WATER.**

If the spa water has reached overheated you should remove the cover to promote heat reduction. The spa Control System should reset itself when the water temperature reduces below 107°F or 43°C. When the spa falls below the reset temperature you can push any button on the topside control to reset the Control System. If the spa will not reset, then shut off power to the spa and call customer service.

Under extreme and/or prolonged weather conditions it is possible for the ambient temperature to exceed 107F/43C, therefore; effecting the water temperature of the spa and causing it to overheat. These conditions could cause the spa sensors to produce an OH message and prevent the usage of your spa during these conditions. The location of your spa should be reconsidered to reduce the outside temperature around the spa. For example, you may need to prevent direct sunlight on any surface of your spa. Regardless, do not enter your spa if the temperature is above 104F.

Should checking the above steps fail to correct the problem, please contact Customer Service at (888) 961-7727 Ext. 8440.

REPLACEMENT PARTS

REPLACEMENT SPA PARTS

| <i>PART NUMBER</i> | <i>DESCRIPTION</i> |
|---------------------------|--|
| 303279 | SPA FILTER – 50sq. ft. Filter |
| 303263 | SPA FILTER – 25sq. ft. Filter (<i>KEY LARGO ONLY</i>) |
| 303530 | EQUIPMENT PACK (<i>CORONADO</i>) |
| 303532 | EQUIPMENT PACK (<i>BERMUDA, KEY LARGO, ANTIQUA, BARBADOS</i>) |
| 303046 | 3.0 hp PUMP (<i>CORONADO</i>) (230V, 2SPD) |
| 303001 | 1.0 hp PUMP (<i>KEY LARGO, ANTIQUA, BARBADOS</i>) (115V, 2SPD) |
| 303535 | 4 BUTTON TOPSIDE CONTROL PANEL |
| 303298 | ROUND FILTER WEIR |
| 303299 | FILTER BASKET SKIMMER |
| 303445 | VORTEX JET |
| 303443 | 7-PORT JET |
| 303307 | LED MULTI-COLOR LIGHT |
| 303574 | OZONATOR |
| 303205 | FILTER LID (<i>LARGE 11 1/4"</i>) |
| 303204 | FILTER LID (<i>SMALL 10 3/4"</i>) |

