

TAYAMA®

8-in1 Multi-Functional Pressure Cooker



User Manual

For Model# TXM-60XL

**IMPORTANT: Do Not Use This Pressure Cooker
Until You Have Read This Entire Manual Thoroughly**

Congratulations

The **Tayama 8-in-1 Multi-Functional Pressure Cooker** is the latest in our distinguished line. We have tested and perfected the right combination of metals, cooking surfaces and digital technology guaranteed to help you get mealtime raves from the whole family. Once familiar with the “one-touch” pre-set system, you’ll find that many of your favorite family recipes can be cooked perfectly in a fraction of the time.

The sealed cooking chamber builds up heat and pressure. The result ... more flavor stays locked within the food and less energy is wasted in a shorter cooking time.

The “sealed” cooking process eliminates messy stovetop spills while “trapping” heat, making for cooler kitchens and easier cleanups.

The **Tayama 8-in-1 Multi-Functional Pressure Cooker** will provide you many years of delicious family meals and memories around the dinner table... but before you begin it is very important that you read this entire manual making certain that you are totally familiar with its operation and precautions.

Table of Contents

Important Safeguards	1
Product Features	3
Product Structure	4
Technical Parameters	4
How It Works	4
Before the First Use	5
Operation Instructions	6
Program Settings Table	7
Function Keys	7
Care and Cleaning	9
Warning	11
Trouble Shooting	12

Important Safeguards

When using electrical appliances, basic safety precautions should always be followed including the following:

- Read and follow all instructions carefully.
- This appliance is not intended for use by persons with reduced physical, sensory or mental capabilities, or lack of experience and knowledge, unless they are under the supervision of a responsible person or have been given proper instruction in using the appliance. This appliance is not intended for use by children.
- Always be sure the float valve is on correctly before use. Incorrect assembly may prevent the cooker from building pressure or allow steam to come out from the sides of the lid.
- Do not touch hot surfaces. Use handles or knobs.
- To protect against electric shock do not immerse or rinse cords or plugs in water or other liquid.
- This appliance should never be operated by children and special care should be taken when the unit is in use in their presence.
- Unplug from outlet when not in use and before cleaning. Allow to cool before putting on or taking off parts.
- Do not operate any appliance with a damaged cord or plug or after the appliance malfunctions or has been damaged in any manner. Return appliance to the nearest authorized service facility for examination, repair or adjustment.
- Do not use any attachments or utensils that were not recommended or supplied by the manufacturer. The use of attachments not recommended for use by the manufacturer may cause serious hazardous situations including personal injury.
- Do not use outdoors.
- Do not let cord hang over edge of table or counter, or touch hot surfaces.
- Do not place on or near a hot gas or electric burner, or in a heated oven.
- Extreme caution must be used when moving an appliance containing hot oil or other hot liquids.
- Always attach plug to appliance first, then plug cord into the wall outlet. To disconnect, set any control to "Off", then remove plug from wall outlet.
- Do not use appliance for anything other than its intended use.
- This appliance cooks under pressure. Improper use may result in scalding injury. Make certain unit is properly closed before operating. See Instructions For Use.
- Never fill the unit above the MAX LINE in the Inner Pot (See Operation Instructions). When using foods that expand during cooking such as rice or dried beans, follow the recipe for "pressure cooking" those products, and as a rule of thumb, do not fill the unit above the "halfway" point. Overfilling may cause clogging, allowing excess pressure to develop. See Instructions For Use.
- Be aware that certain foods, such as applesauce, cranberries, pearl barley, oatmeal or other cereals, split peas, noodles, macaroni, rhubarb, and spaghetti, can foam, froth, sputter, and clog the pressure release device (steam vent). Recipes using these items must be followed carefully to avoid problems.
- Always check the pressure release devices for clogs before use.
- Do not open the pressure cooker until the unit has cooled and all internal pressure has been released. If the unit is difficult to open, this indicates that the cooker is still pressurized – do not force it open. Any pressure in the cooker can be hazardous. See Instructions For Use.
- Do not use this pressure cooker for pressure frying with oil.
- This appliance has been designed for use with a 3 prong, grounded, 120V electrical outlet only. Do not use any other electrical outlet.
- The pressure cooker generates extreme heat and steam in its operation. All necessary precautions must be taken to avoid fire, burns and other personal injury during its operation.

- When in operation the pressure cooker requires sufficient air space on all sides including top and bottom. Never operate the unit near any flammable materials such as dish towels, paper towels, curtains, paper plates, etc.
- Always plug the electrical cord directly into the wall outlet. Never use this unit with an extension cord of any kind.
- Anyone who has not fully read and understood all operating and safety instructions contained in this manual is not qualified to operate or clean this appliance.
- If this unit falls or accidentally becomes immersed in water, unplug it from the wall outlet immediately. Do not reach into the water!
- Do not operate this appliance on an unstable surface.
- If this appliance begins to malfunction during use, immediately unplug the cord. Do not use or attempt to repair a malfunctioning appliance!
- NEVER FORCE OPEN pressure cooker. If you need to open the pressure cooker, press the "KEEP WARM/CANCEL" button and using tongs or a kitchen tool carefully rotate the Pressure Valve to the OPEN/VENT position to fully release the building pressure inside the cooker. Make sure that all the steam has dissipated from the cooker. Carefully turn the handle clockwise to open. Always open the lid away from you to avoid skin contact with any remaining heat or steam.
- CAUTION: TO REDUCE RISK OF ELECTRIC SHOCK, COOK ONLY IN THE REMOVABLE CONTAINER. Do not immerse the housing or base in water. Before use, clean the bottom of the Inner Pot and the surface of the heater plate... insert the Inner Pot, slightly clockwise and counterclockwise may cause damage to the unit.

until you are sure it is sitting correctly on the heater plate. Failure to do so will prevent proper operation and prevent the risk of personal injury, fires, and damage to property.

SHORT CORD INSTRUCTIONS

A short power-supply cord is provided to reduce the risk resulting from becoming entangled in or tripping over a longer cord. Do not use an extension cord with this product.

ELECTRIC POWER

If the electrical circuit is overloaded with other appliances, your appliance may not operate properly. It should be operated on a dedicated electrical circuit.

NOTE: This product must be grounded. If it should malfunction or break down, grounding provides a path of least resistance for electric current to reduce the risk of electric shock. This product is equipped with a cord having an equipment grounding conductor and a grounding plug. The plug must be plugged into an appropriate outlet that is properly installed and grounded in accordance with all local codes and ordinances.

PLEASE SAVE THESE INSTRUCTIONS.

And keep the user manual in a convenient place for future reference.

Product Features

Special Features

- The Digital Display on your Pressure Cooker offers a wide range of choices including Low Temp Cooking, Stewing, Steaming and much more.
- Cooking Time and Pressure Levels may be adjusted to suit any recipe or personal preference. At the completion of the cooking cycle, the unit will automatically shift to the KEEP WARM mode.
- Digital Pressure Cooking utilizes temperatures up to 248° F (120° C) creating a more sterile and healthier environment when compared to traditional cooking methods.
- The Pressure Vent feature allows you to lower pressure quickly and completely. To do so, carefully rotate the Pressure Valve to the Vent position using tongs or another kitchen tool.

Never use bare hands.

CAUTION: During this process protect your skin from any contact with escaping steam.

- The STEAM mode heats cooking liquid in the Inner Pot to a boil in a matter of minutes, for steaming and cooking an endless variety of foods.
- The KEEP WARM mode holds and keeps cooked food warm for an extended period of time. Foods kept at KEEP WARM mode for periods beyond 4 hours may lose their good flavor and texture.

Built-In Safety Features

1. Lid Safety Device: Prevents pressure build-up if lid is not closed properly and prevents lid from opening until all pressure is released.
2. Pressure and Temperature Sensor Controls: Maintain even heat and pressure by automatically activating or deactivating the power supply.
3. “Back-up” Safety Release Valve: Should the Temperature/Pressure Sensor device malfunction, causing pressure to build beyond maximum setting, the “Back-Up” will automatically “kick in” and release the built up pressure.
4. “Clog Resistant” Feature: Prevents food from

blocking the steam release port.

5. “Spring-Loaded” Safety Pressure Release: Should all safety features listed above fail, this “spring-loaded” device located beneath the heating element will automatically lower the Inner Pot, causing it to separate automatically from the Rubber Gasket. This will enable the steam and pressure to automatically escape around the pot Lid, avoiding a dangerous situation.
6. Temperature “Cut-Off” Device: Should the unit malfunction and cause the internal temperature to rise beyond the “Safe” limit, this device will cut-off the power supply and will not automatically reset.

Product Structure

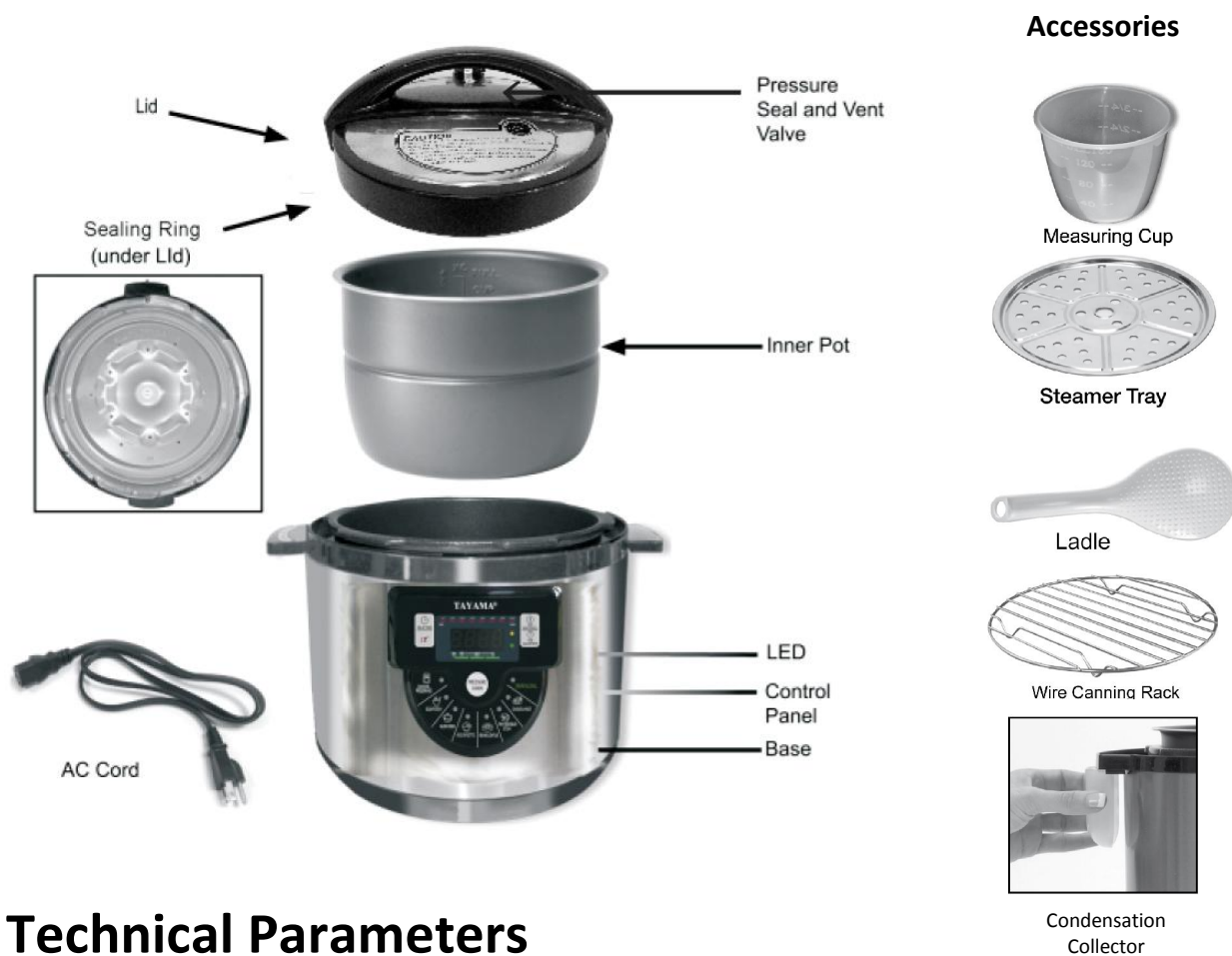

Technical Parameters

Model	Power Supply	Power	Capacity	Caliber	Working Pressure	Pressure Limit	Warming Temperature	Timer
TMC-60XL	120V~60Hz	1000W	6L	22cm	0~0.7 bar	0.9 bar	60~80	0.5~24 hrs

How It Works

Each function is programmed for different cooking times based upon the type of food being cooked. After plugging unit into appropriate electrical outlet, select one of the following cooking functions:

Canning/Preserving
Beans/Lentils

Soup/Stew
Fish/Vegetables

Slow Cook
Chicken/Meat

Rice/Risotto
Manual

- The pressure cooking time will display on the LED panel. In approximately 5 seconds, the LED will go blank then display a rotating pattern of “dash” movements. This indicates the Pressure Cooker is heating up the cooking pot and the temperature and pressure is rising inside.

- When the pressure reaches a predetermined level, a small amount of steam will release from the floater valve and the floater valve will rise.
- When the steam stops releasing the unit is sealed. Shortly thereafter, the Pressure Cooker reaches the selected pressure level and the timer begins its countdown on the LED display.
- When the LED counts down to 00:00 a beeping sound will indicate that cooking is complete and the unit will shift automatically to Keep Warm mode which is indicated by the “Keep Warm” light.
- The lid cannot be opened until pressure is released. Allow pressure to release naturally, or adjust pressure valve from “Seal” position to “Vent” position to release pressure rapidly.

Before the First Use

Before the first use, please take out all accessories from the package and read this manual carefully. Please pay particular attention to operational instructions and cautions to avoid any injury or property damage. Please wash the inside of the lid and the inner pot with warm soapy water, rinse and dry thoroughly. Wipe the outer housing with a clean damp cloth. **Never immerse the cooker housing in water or any other liquid.** Never clean the lid and housing in a dishwasher

To ensure correct fitting of the Rubber Gasket, fill the Inner Pot with water about 2/3 full, place the Lid on the cooker, then Rotate the Pressure Valve to the “Seal” position and run on CANNING mode for 10 minutes. When the cycle is complete, using tongs or another kitchen tool, carefully rotate the Pressure Valve to the “Vent” position allowing all pressure to escape. Let the appliance cool to room temperature. Pour out the water. Rinse and towel dry the Inner Pot. The Pressure Cooker is now ready for use.

#1 Lid (underside) Lid Liner/Sealing Ring

For proper cleaning the Sealing Ring should be removed. Using the Pull Tab located beneath the Lid, remove the Pot Lid Liner that holds the Sealing Ring. After cleaning, re-attach Sealing Ring to Lid Liner and snap back in place.

#2 Placing the Lid on the Cooker

Place Inner Pot into the unit. Never load Inner Pot above the MAX line. Rotate the Inner Pot to make certain that it is seated properly. Place Lid on Cooker with Handle and Recessed Valve pointed to the “10:00 o’clock” position. Rotate Lid counter-clockwise until you feel a click.

HOT LID WARNING: Use black composite handle only when opening lid. The stainless steel parts become very hot and could burn your hands.

#3 Pressure Valve

WARNING: Avoid serious injury... Never use your hand to set the Pressure Valve in the "Vent" Position after any cooking process. Use tongs or some other kitchen tool.

#4 Condensation Collector

The Condensation Collector easily picks up any moisture that may drip off when using your Pressure Cooker. Simply align and push the collector into the channels on the back of the cooker. Empty and clean after each use.

Operation Instructions

1. To Open Lid – Grip Lid Handle, turn clockwise, as indicated on the handle, and lift upward. (See picture 1, 2 and 3)

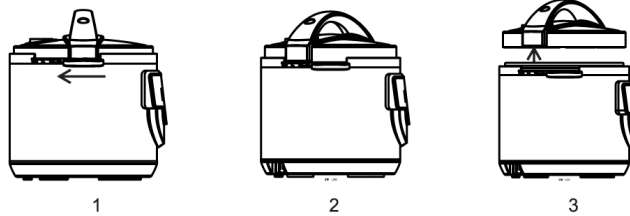

2. Remove the Inner Pot and place cooking ingredients inside. Monitor the level of the water and ingredients per cooking instructions to ensure they do not exceed the MAX LINE "4/5" marking on the Inner Pot. (See picture 4) Rice, beans or other ingredients that will expand during cooking should not be filled beyond the "3/5" marking. (See picture 5) Liquids and ingredients together should never fill less than the "1/5" marking on the Inner Pot. (See picture 6)

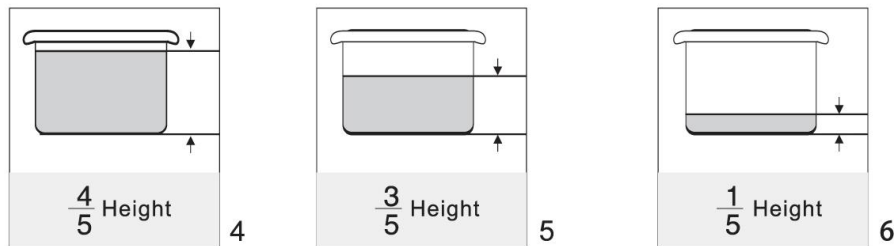

3. Clean and towel dry the external surface of the Inner Pot. Place Inner Pot inside the cooker, rotating it slightly to ensure proper contact with the heating element. Make sure there is no material between the Inner Pot and the Outer Pot before you insert it into the cooker. (See picture 7)



7

4. To Close Lid – Place Lid on Pressure Cooker, turn handle counter-clockwise to CLOSE position, as indicated on the handle until lid locks in place. (See pictures 8, 9, 10 and 11)

NOTE: Make sure lid is closed and properly aligned before use.

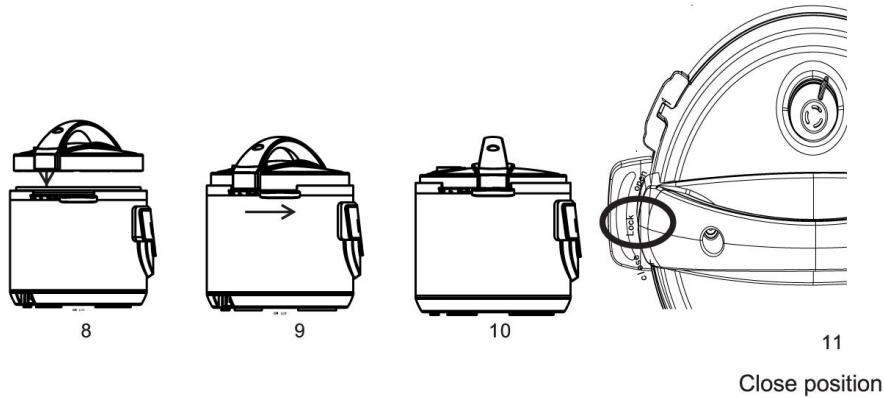

Program Settings Table

Functions	Canning/ Preserving	Soup/ Stew	Slow Cook	Rice/ Risotto	Beans/ Lentils	Fish/ Veg. Steam	Chicken/ Meat	Manual
Default Time	45 mins	30 mins	6 hrs	18 mins	15 mins	4 mins	40 mins	10 mins
Default Pressure	High	Medium	N/A	Medium	High	Low	Low	Medium
Default Temperature	200	160	90	160	160	140	140	140
Time Adjustment	10-120 mins	10-60 mins	2-720 mins	6-25 mins	5-30 mins	2-10 mins	15-60 mins	1-720 mins
Pressure Adjustment L-M-H	L-M-H	L-M-H	N/A	L-M-H	L-M-H	L-M-H	L-M-H	L-M-H
Temperature Adjustment	N/A	110-200	N/A	130-180	90-200	90-200	90-200	90-200

Refer to the Program Settings Table above for the specific cooking functions and select desired function. The unit will cook automatically based on the preset function/time.

Function Keys

After selecting a cooking function (**Canning/Preserving, Soup/Stew, Slow Cook, Rice/Risotto, Beans/Lentils, Fish/Vegetables/Steam, Chicken/Meat, Manual**) the default time will display in the LED window. To customize your dish optional functions are available: Time Adjustment, Temperature Adjustment or Pressure Adjustment. The selected setting will be display for 5 seconds in the LED display. Then a rotating effect will appear on the screen. Once pressure is built, the rotating effect will end and the display will begin to count down the time. When the process is completed, the unit will beep and enter KEEP WARM mode until cancelled.

Manual Button

The “**Manual**” key allows manual setting of cooking time. The time set in this mode is pressure cooking time which will begin to count down when working pressure is reached. The maximum pressure cooking time is 720 minutes (12hours).

Note: “Sauté Function” For open lid sautéing, browning or simmering inside the inner pot. "Pressure Adjustment" can be used to change the operating temperature in 3 modes or by using “Temperature Adjustment”.

Delay Timer Button The “**Delay Timer**” key is for delayed cooking. To start delayed cooking, first select the “Delay Timer” key. Pressing "Delay Timer" key again will add additional 30 minutes. Once desired start time is reached select desired cooking function. **The time you are setting is the delayed time before the program starts.** Please allow sufficient cooking time and cooling down time before serving. The time delay can be adjusted for up to 24 hours.

T° Temperature Button

After selecting a cooking function, press “**T°**” to adjust the Temperature Setting. Available Temperature Setting will appear on the LED Display. Please refer to the “Program Settings Table” section for details.

Keep Warm/Cancel Button

Press “**Keep Warm/Cancel**” will cancel the program and take the cooker to standby state. When the cooker is in standby state, pressing this key activates the keep-warm program.

Time Adjustment Button

Press “**Time Adjustment**” function to adjust cooking time (in minutes) according to food or personal preference. Please refer to the “Program Settings Table” section for details.

Note: “White Rice”, “Brown Rice” and “Wild Rice” Function.

For cooking rice, select “Rice/Risotto” button, then press “Time Adjustment” button. For White Rice adjust the time to 6 minutes. For Brown Rice, the default time is 18 minutes. For Wild Rice adjust the time to 25 minutes. (See pictures 12 and 13)

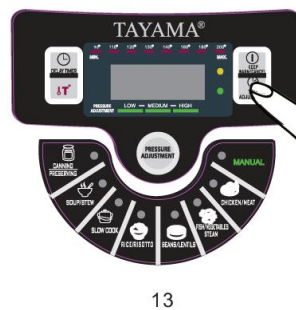
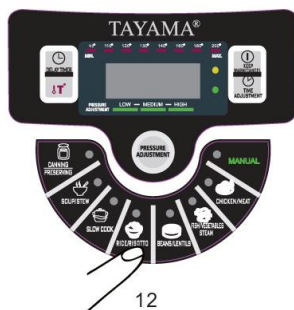

Pressure Adjustment Button

When a specific cooking program is selected, the unit will display the default time in the LED window and the “Pressure Adjustment : Low, Medium, or High” indicator below the LED window will light. Should your recipe or personal taste require “Medium” or “High” results, you may select those options by pushing the Pressure Adjustment button. For “Medium” indicator light for Low and Medium will light; for “High” all 3 indicator lights Low, Medium, and High will light. Please refer to the “Program Settings Table” section for details.

When the LED displays 00:00 and the unit beeps, cooking is complete. Do not attempt to open the lid immediately as the pressure is very high in the cooking pot. Only after the float valve drops and pressure has released, should the lid be opened.

To release pressure rapidly turn the pressure valve forward to the “Vent” position. Do not touch the pressure valve with your hands- use tongs or another tool. (See picture 17)

CAUTION MUST BE USED WHEN RELEASEING THE PRESSURE TO PREVENT BURNING.

If cooking liquids (soups, stews, etc.), it is best to let pressure release naturally to avoid hot liquid erupting through the steam vent.

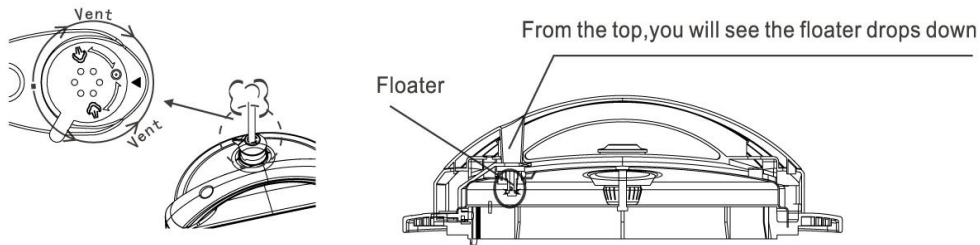

17

Care and Cleaning

CLEANING THE SAFETY DEVICES: In addition to the Lid Liner, the other safety devices on the Pressure Cooker must also be cleaned after each use.

THE PRESSURE VALVE: To remove the Pressure Valve, simply pull up and valve will release from its spring lock mechanism. Apply mild detergent and wash it under warm running water. After cleaning, check to see that the interior spring-loaded part moves freely by pressing down on it. Put the Pressure Valve back in place by pushing it down onto the spring-loaded mechanism. This appliance requires little maintenance. It contains no user serviceable parts. Do not try to repair it yourself. Contact customer service for qualified repair information.

TO CLEAN: After use, unplug unit and allow to cool completely before cleaning. The Pressure Cooker must be cleaned thoroughly after each use in order to avoid staining caused by a build-up of food or cooking residue, and to ensure that the safety devices operate correctly.

DO NOT POUR COLD WATER INTO A HOT PRESSURE COOKER.

NOTE: To ensure safe operation of this Pressure Cooker, strictly follow the cleaning and maintenance instructions after each use, should a tiny bit of food (such as a grain of rice or pea shell) remain in the unit, it could prevent the safety devices from operating during subsequent use.

IMPORTANT: Always remove the Pressure Valve and clean the opening with pin to remove any blockage that might have occurred during the cooking process.

This must be done after each use. The removable cooking pot and Lid are immersible for cleaning.

Rinse cooking pot and Lid under hot running water. Use only a mild liquid detergent and a soft cloth, sponge or nylon scrubber for cleaning. Do not use abrasive powders, bicarbonate of soda or bleach. Do not use scouring pads.

WIPE BASE AFTER EACH USE WITH A SOFT, DAMP CLOTH OR SPONGE, MAKING SURE ALL FOOD RESIDUE IS REMOVED.

DO NOT IMMERSE BASE IN WATER

When cleaning the Lid, the Sealing Ring must be removed and washed separately with a sponge or soft cloth and warm, soapy water.

1. Unplug and let the Pressure Cooker cool to room temperature before cleaning.
2. Wash the removable Inner Pot with warm, soapy water and clean with a soft sponge. Rinse off with clean water and towel dry.
3. Wipe the mirror finished outer housing with a damp soft cloth or sponge. Do not submerge in water or spray water on the pressure cooker.
4. Never use harsh chemical detergents, scouring pads or powders on any of the parts or components.
5. Always check that the Pressure Valve and Float Valve are in good working order and debris free.
6. Remove the Lid Liner/Sealing Ring from the lid as outlined below. Wash inside Lid Liner/Sealing Ring, Floater Valve, and Steam Vent with warm soapy water. (See pictures 18 and 19)

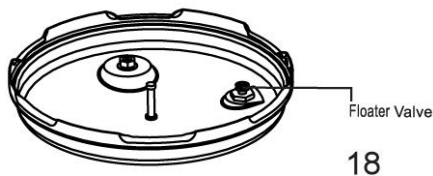

7. To remove the Lid Liner/Sealing Ring from the lid, pull on the small metal knob located on the face of the liner until the liner separates from the lid. The Sealing Ring should be separated from the Lid Liner for proper cleaning. (See picture 20)

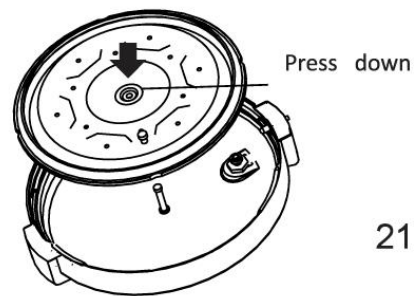
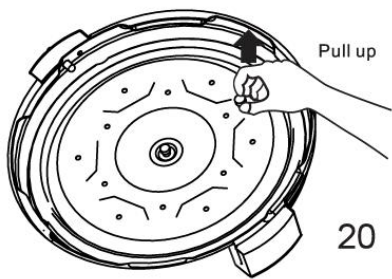

8. To reinsert the Lid Liner/Sealing Ring, align the center hold in the Lid Liner with raised metal shaft located in the center of the Inner Lid and press firmly into place. The Lid Liner is not reversible and therefore must be correctly inserted into the lid. (See picture 21)

Warning

USE EXTREME CAUTION DURING OPERATION

1. Do not place hands near, or come in close contact with the pressure release valve when pressure release is in process. Burns, scalding and/or injury may result.
2. Do not touch the lid during the cooking process, or while unit is hot and pressurized.
3. Do not cover the gap between the lid and the outer cooker. Do not cover the pressure cooker.
4. Keep away from children
5. Do not place the Inner Pot on other heat sources.
6. Do not use metal utensils when removing food from the Inner Pot as they may scratch the surface of the pot.
7. Do not disassemble the unit. Only use replacement parts certified and provided by the manufacturer.
8. During operation, if the unit sounds an alarm and/ or the display shows Error codes (E01, E02, E03 or E04), please stop using and contact Customer Service for assistance.
9. After cooking, unplug the power supply before enjoying your meal.

IMPORTANT INFORMATION

If there is steam coming out the sides and the Pressure Valve on top of the Lid is in the "Seal" position, then the Lid has not seated. This sometimes happens when the unit is new. If the Sealing Ring is in place try pushing down on the Lid. This should seal the Lid and the steam should stop coming out. It is also important to be sure the Float Valve is assembled correctly. Incorrect assembly may cause steam to come out the sides or prevent pressure from building. The Float Valve should be able to move up and down freely only stopping when the silicon gasket meets the Lid. It is however normal for condensation to appear in the condensation collector.

Trouble Shooting Table

	Problem		Possible Reason	Solution	
1	Difficult to close the lid		Sealing ring not installed properly	Position the sealing ring well	
			Float valve in the popped-up position	Press the float valve lightly downwards	
2	Difficult to open the lid		Pressure exists inside the cooker	Use the pressure valve to reduce the internal pressure. Open the lid after the pressure is completely released.	
			Float valve stuck at the popped-up position	Press the float valve lightly with a pen or chopstick.	
3	Steam leaks from the side of the lid		No sealing ring	Install the sealing ring	
			Sealing ring damaged	Replace the sealing ring	
			Food debris attached to the sealing ring	Clean the sealing ring	
			Lid not closed properly	Open then Close the lid again	
4	Steam leaks from float valve for over 2 minutes		Food debris on the float valve silicone seal	Clean the float valve silicone seal	
			Float valve silicone ring worn-out	Replace the float valve silicone ring	
5	Float valve unable to rise		Too little food or water in inner pot	Add water according to the recipe	
			Air escaping from the rim of the lid or from the pressure valve	Check to ensure lid liner and sealing ring are properly installed and pressure valve is in seal position	
6	Steam comes out from exhaust valve non-stop		Steam release handle not in sealing position	Turn the release handle to the sealing position	
			Pressure control fails	Contact support online	
7	All LEDs flash with a code appearing on screen		E01 code	Faulty temperature sensor (cannot be detected)	Contact support online
			E02 code	Faulty temperature sensor (short circuited)	Contact support online
			E03 code	Temperature is too high because inner pot is not placed properly, heat cannot transmit	Put in the inner pot properly and remove any food debris on the pot
				Temperature is too high because there is no water in inner pot	Put food and water in the inner pot
			E04 code	Faulty pressure sensor	Contact support online

Tayama Appliance USA Inc.
www.tayama-usa.com