

ASSEMBLY INSTRUCTIONS

STOCK NO:S010114

Two Person Swing



WARNING

- This swing must be installed on level ground.
- Assemble 6 feet or more away from obstruction such as fence, garage, house, hot grills, overhanging branches, laundry wires and electrical wires...etc.
- Tighten all nuts, bolts and components during assembly and periodically during usage, fail to do so will be on your own risk
- Lubricate all moving parts during usage season.
- It is advisable to wear goggles during assembly.
- It is recommended that two or more person assemble this swing.
- Use with proper cautions especially accompany with young children. Gentle swing action is recommended for both adult and young children. Younger children should not be left alone without adult accompany on the swing.
- Maximum weight capacity 400 pound.
- Make sure to have help when removing seat from the frame or when moving the swing.
- No machine wash or dry clean for all the fabric materials, use hand wash with care only.










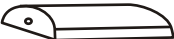












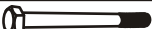









Made in Taiwan

ASSEMBLY INSTRUCTIONS

STOCK NO:S010114

Two Person Swing

Before you start:
Check Your Package. Your carton should contain all items shown in the Parts List.

Parts List							
No.	Item		Description		QTY		
#1			Top Cross Bar		1		
#2			Side Frame Tube		4		
#3			Side Decoration		2		
#4			Armrest		R	1	
					L	1	
#5			Front Seat Swing Arm (Long)		2		
#6			Rear Seat Swing Arm (Short)		2		
#7			Cushion (Seat & Back)		1		
#8			Back Cross Bar		1		
#9			Seat Cross Bar		1		
#10			Canopy Cover		1		
#11			Canopy Frame		2		
#12			Canopy Side Brace		2		
No.	Item	Description	QTY	No.	Item	Description	QTY
#13		Adjustment Knob	2	#23		Screw: M6 X40	4
#14		Foot	4	#24		Round Bolts	2
#15		3-Way Hook	2	#25		Large Caps	26
#16		Hook	4	#26		Small Caps	8
#17		Spacer	2	#27		Caps Nuts	4
#18		Screw: M8 X105	4	#28		Large Locknut	10
#19		Screw: M8 X70	2	#29		Small Locknut	4
#20		Screw: M8 X40	2	#30		Large Washer	26
#21		Screw: M8 X20	8	#31		Small Washer	8
#22		Screw: M6 X70	4	#32		Wrench	2

Please read instructions thoroughly before assembling swing.

Tools you will need: 2 x wrenches, included.

Machine screw, washer, nut and plastic nut cover assembling diagram:


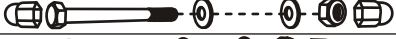
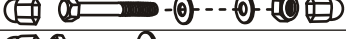



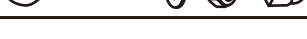
A		M8 X 105	4
B		M8 X 70	2
C		M6 X 70	4
D		M8 X 40	2
E		M8 X 20	8
F		M6 X 40	4
G		Hook with M8nut	4

FIGURE 1

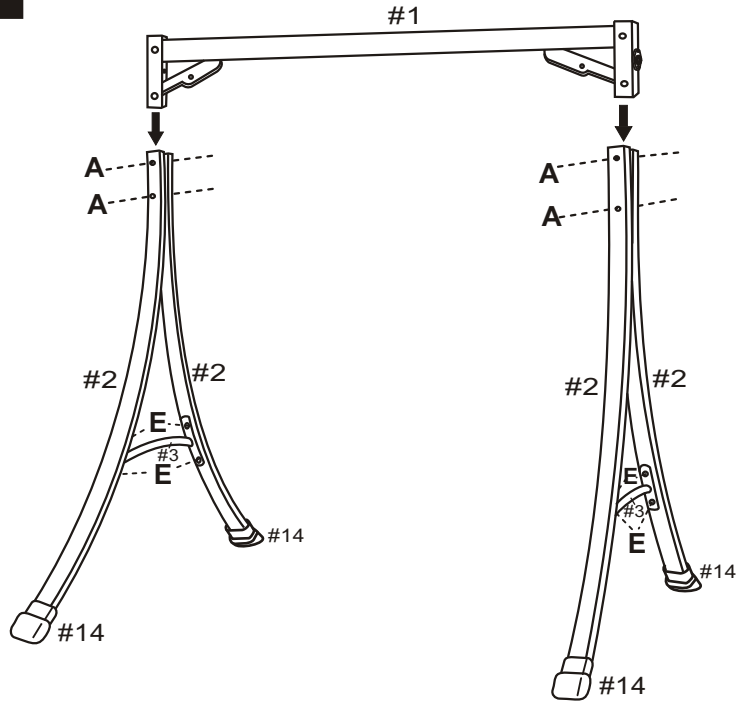


FIGURE 2

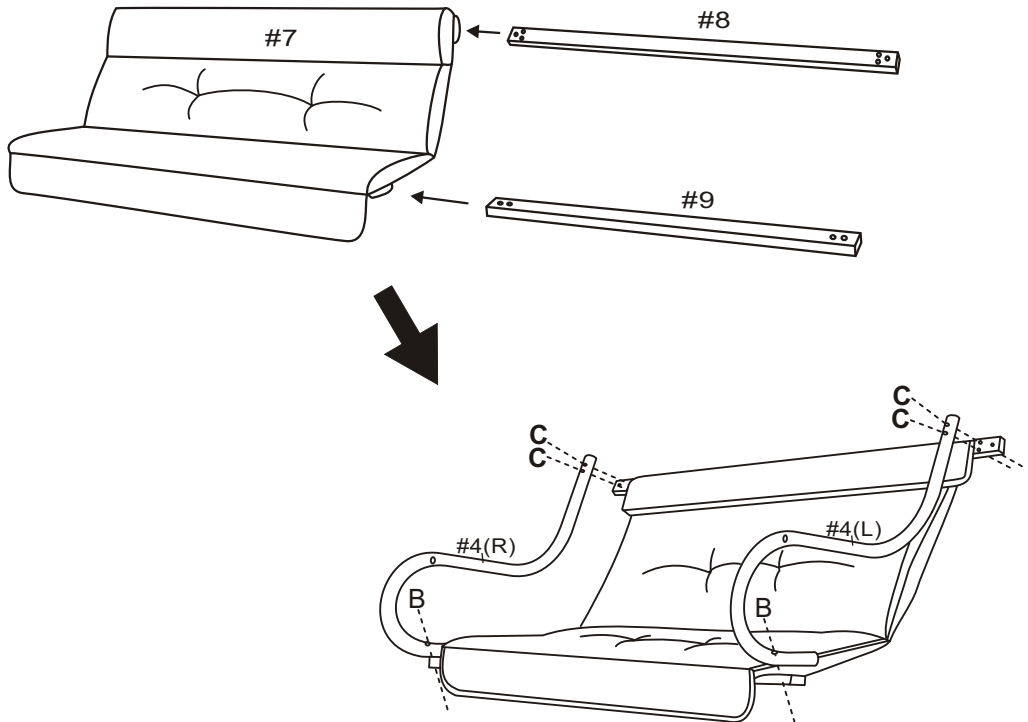


FIGURE 3

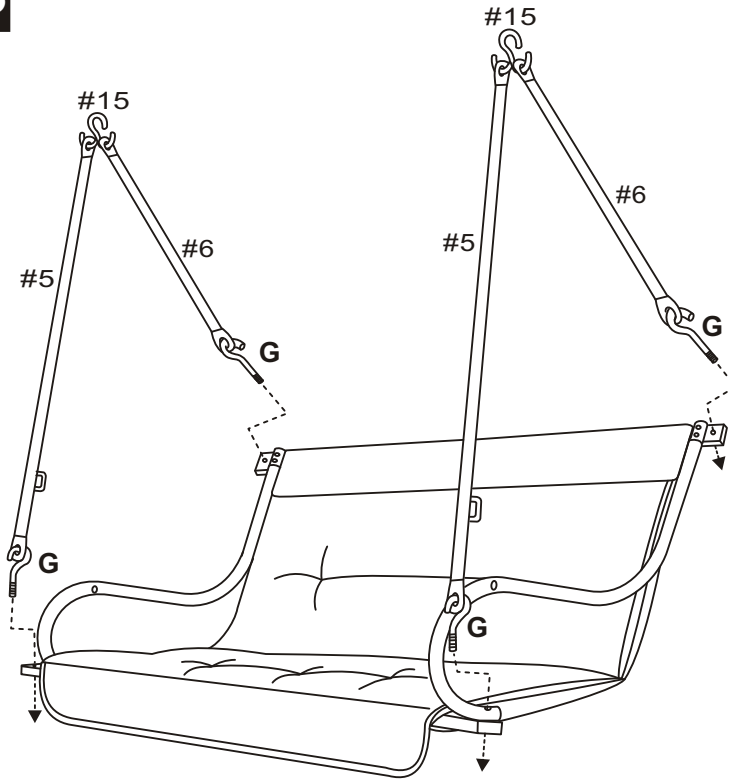


FIGURE 4

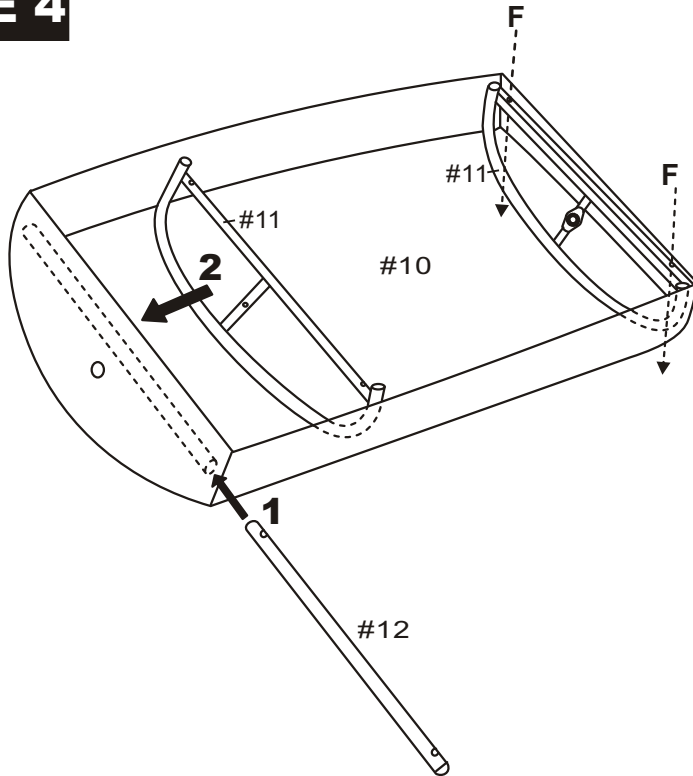


FIGURE 5

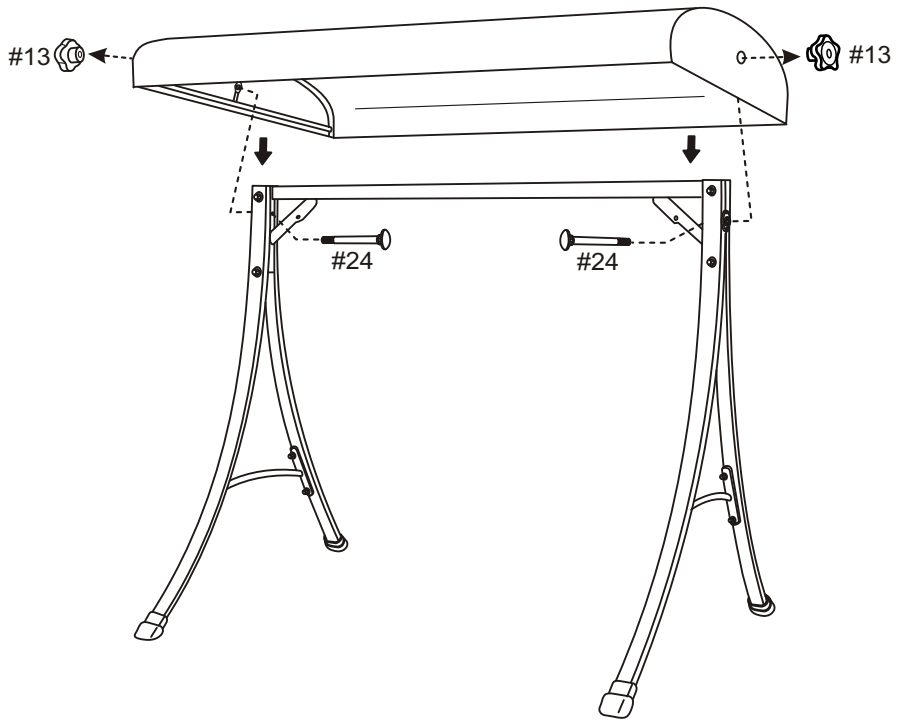


FIGURE 6

