



ENGLISH

ESPAÑOL

OWNER'S MANUAL GAS DOUBLE OVEN RANGE

Please read this guide thoroughly before operating
and keep it handy for reference at all times.

LDG3017ST

3 PRODUCT FEATURES

4 IMPORTANT SAFETY INSTRUCTIONS

10 BEFORE USE

- 10 Accessories
- 11 Components

12 HOW TO USE

- 12 How to use Gas Surface Burners
 - 12 - Before Use
 - 13 - Gas Burners
 - 13 - Using the Gas Surface Burners
 - 14 - Top-of-Range Cookware
 - 15 - Using the Griddle
- 16 How to Use the Oven
 - 16 - Before Use
 - 18 - Using the Control Panel
 - 20 - Operating Instructions
 - 23 - Removing and Replacing the Oven Racks
 - 24 - BAKE (Upper & Lower Oven)
 - 25 - Preheating and Pan Placement
 - 25 - SPEED BROIL (Upper Oven)
 - 29 - TIMED COOK (Upper & Lower Oven)
 - 29 - DELAYED TIMED COOK (Upper & Lower Oven)
 - 30 How to use convection for the lower oven
 - 30 - CONVECTION BAKE FOR THE LOWER OVEN
 - 31 - CONVECTION ROAST FOR THE LOWER OVEN
 - 32 Special Features
 - 32 - KIDS MEAL (Upper Oven)
 - 32 - WARM (Upper & Lower Oven)
 - 33 - PROOF (Lower Oven)
 - 33 - FAVORITE (Lower Oven)
 - 34 - SABBATH (Upper & Lower Oven)

35 CARE AND CLEANING

- 35 Gas Surface Burner
 - 35 - Removing and Replacing the Gas Surface Burner
 - 35 - Burner Heads/Caps
 - 36 - Burner Grates
 - 37 - Cooktop Surface
 - 37 - Stainless Steel Surfaces
 - 37 - Oven Air Vents
 - 37 - Control Panel
 - 37 - Front Manifold Panel and Knobs
 - 38 - Oven Door
 - 38 - Removing and Replacing the Doors
- 40 Inside of the Oven
 - 40 - SELF CLEAN (Upper & Lower Oven)
 - 42 - Changing the Oven Light
 - 42 - Broiler Pan and Grid (Sold separately)
 - 42 - Oven Racks

43 BEFORE REQUESTING SERVICE

45 WARRANTY

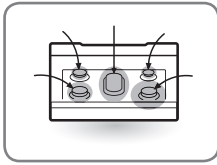

MULTIPLE GAS BURNER SIZES

Choose a burner to fit the size of your cookware.
Cooking multiple items at once is possible by using different burners at the same time.



SAFE, CONVENIENT AND GREEN GAS RANGE

Provides safety and convenience for cooking, as well as green technology.
Superboil (17000 BTU) can quickly bring a pot of water to a boil.



UPPER OVEN / LOWER OVEN

Separate upper and lower ovens.
Choose to use either oven, or both, depending on the size of your food.

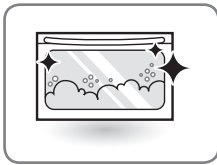

SELF CLEAN

Good for easy cleaning.

IMPORTANT SAFETY INSTRUCTIONS

Always comply with the following precautions to avoid dangerous situations and to ensure the peak performance of your product.

WARNING

Indicates a hazardous situation which, if not avoided, could result in death or serious injury.

CAUTION

Indicates a hazardous situation which, if not avoided, could result in minor or moderate injury.

WHAT TO DO IF YOU SMELL GAS

1. Open windows.
2. **DO NOT** try to light any appliance.
3. **DO NOT** touch any electrical switch.
4. **DO NOT** use any phone in your building.
5. Immediately call your gas supplier from a neighbor's phone. Follow the gas supplier's instructions.
6. If you cannot reach your gas supplier, call the fire department.

ANTI-TIP DEVICE

WARNING

- ALL RANGES CAN TIP
- INJURY TO PERSONS COULD RESULT
- INSTALL ANTI-TIP DEVICES PACKED WITH RANGE
- SEE INSTALLATION INSTRUCTIONS



- **DO NOT step or sit on the door. Install the Anti-Tip Bracket packed with this range.**
 - The range could be tipped and injury might result from spilled hot liquid, food, or the range itself.
 - If the range is pulled away from the wall for cleaning, service, or any other reason, ensure that the Anti-Tip Device is properly reengaged when the range is pushed back against the wall.

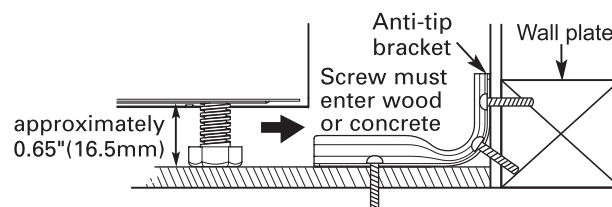

- To reduce the risk of the range tipping over, the range must be secured by properly installing the anti-tip devices.
- To check that the anti-tip bracket is properly installed: Remove any items on the cooktop. Grasp the top rear edge of the range back guard and carefully attempt to tilt it forward. Verify that the anti-tip devices are engaged.
- Remove the warming or storage drawers and visually inspect that the rear leveling leg is fully inserted into the anti-tip bracket.
- Refer to the installation manual for proper anti-tip bracket installation.

IMPORTANT SAFETY NOTICE

Enforcement Act requires the Governor of California to publish a list of substances known to the state to cause birth defects or other reproductive harm, and requires businesses to warn customers of potential exposure to such substances.

Gas appliances can cause minor exposure to four of these substances, namely benzene, carbon monoxide, formaldehyde and soot, caused primarily by the imperfect combustion of natural or LP gas.

Correctly adjusted burners, indicated by a bluish rather than a yellow flame, will minimize imperfect combustion. Exposure to these substances can be minimized by opening windows or using a ventilation fan or hood.

SAFETY PRECAUTIONS

Have the installer show you the location of the range gas shut-off valve and how to shut it off if necessary.

- Make sure your range is properly installed and grounded by a qualified installer, according to the installation instructions. Any adjustment and service should be performed only by qualified gas range installers or service technicians.
- Plug your range into a 120-volt grounded outlet only. Do not remove the round grounding prong from the plug. If in doubt about the grounding of the home electrical system, it is your personal responsibility and obligation to have an ungrounded outlet replaced with a properly grounded, three-prong outlet in accordance with the National Electrical Code. Do not use an extension cord with this range.
- **DO NOT** use an adapter plug, an extension cord, or remove the grounding prong from the electrical power cord to prevent fire hazard or electrical shock. Failure to follow this warning can cause serious injury, fire or death.
- To prevent poor air circulation, place the range out of kitchen traffic path and out of drafty locations.
- **DO NOT** attempt to repair or replace any part of your range unless it is specifically mentioned in this manual. All other services should be referred to a qualified technician.
- Make sure that all packaging materials are removed from the range before operating it to prevent fire or smoke damage should the packaging material ignite.
- Make sure your range is properly adjusted by a qualified service technician or installer for the type of gas (natural or LP) that is to be used. Your range can be converted for use with either type of gas. See the installation instructions.

WARNING

These adjustments must be done by a qualified service technician according to the manufacturer's instructions and all codes and requirements of the authority having jurisdiction. Failure to follow these instructions could result in serious injury or property damage. The qualified agency performing these adjustments assumes responsibility for the conversion.

- After using your range for a long time, high floor temperatures may result and many floor coverings will not withstand this kind of use.
- **NEVER** install the range over vinyl tile or linoleum that cannot withstand such type of use. Never install it directly over interior kitchen carpeting.

CAUTION

Items of interest to children should not be placed in cabinets above a range or on the backsplash of a range—children climbing on the range to reach items could be seriously injured.

- **DO NOT** leave children alone or unattended where a range is hot or in operation. They could be seriously burned.
- **DO NOT** let anyone climb, stand or hang on the oven door, warming drawer or cooktop. They could damage the range and even tip it over, causing severe personal injury.

WARNING

- **NEVER** use your range as a space heater to heat or warm the room. Doing so may result in carbon monoxide poisoning and overheating of the oven.
- **NEVER** wear loose fitting or hanging garments while using the appliance. Be careful when reaching for items placed in cabinets over the range. Flammable materials could be ignited if brought in contact with flame or hot oven surfaces and may cause severe burns.
- **DO NOT** place flammable materials in the oven or near the cooktop.
- **DO NOT** place or use combustible materials such as gasoline or other flammable vapors and liquids in the vicinity of this or any other appliance.
- **DO NOT** allow cooking grease or other flammable materials in or near the range.
- **DO NOT** use water on grease fires. Never touch a flaming pan. Turn the controls off. Smother a flaming pan on a surface burner by covering the pan completely with a well-fitting lid, cookie sheet or flat tray. Use a multi-purpose dry chemical or foam-type fire extinguisher.

A grease fire can be put out by covering it with baking soda or, if available, by using a multi-purpose dry chemical or foam-type fire extinguisher.

Flame in the upper oven or lower oven can be smothered completely by closing the oven door and turning the control to off or by using a multi-purpose dry chemical or foam-type fire extinguisher.

- **DO NOT** use the oven or the drawer for storage.
- Let the burner grates and other surfaces cool before touching them.
- **NEVER** block the vents (air holes) of the range. They provide the air inlet and outlet that are necessary for the range to operate properly with correct combustion. Air openings are located at the rear of the cooktop, at the top and bottom of the oven door, and at the bottom of the range.
- **NEVER** cover any slots, holes or passages in the oven bottom or cover an entire rack with materials such as aluminum foil. Doing so blocks air flow through the oven and may cause carbon monoxide poisoning. Aluminum foil linings may also trap heat, causing a fire hazard.
- **NEVER** obstruct the flow of combustion and ventilation air by blocking the oven vent or air intakes. Doing so restricts air to the burner and may result in carbon monoxide poisoning.
- Large scratches or impacts to glass doors can lead to broken or shattered glass.
- Stepping, leaning or sitting on the doors or drawers of this range can result in serious injuries and also cause damage to the range. Do not allow children to climb or play around the range. The weight of a child on an open door may cause the range to tip, resulting in serious burns or other injury.
- Gas leaks may occur in our system and result in a dangerous situation. Gas leaks may not be detected by smell alone. Gas suppliers recommend you to purchase and install a UL approved gas detector. Install and use in accordance with the gas detector manufacturer's instructions.
- Leak testing of the appliance shall be conducted according to the manufacturer's instructions.
- **DO NOT** use commercial oven cleaners on the oven finish or around any part of the oven. They will damage the finish of parts.
- To prevent staining or discoloration, clean appliance after each use.
- **DO NOT** attempt to open or close the door or operate the oven until the door is properly installed.
- **NEVER** place fingers between the hinge and front oven frame. Hinge arms are spring mounted. If accidentally hit, the hinge will slam shut against the oven frame and could injure your fingers.

CAUTION

- **DO NOT** use the oven for storing food or cookware.
- To prevent damage to the oven door, do not attempt to open the door when Lock is displayed.
- **DO NOT** place excessive weight or stand on an open door. This could cause the range to tip over, break the door, or injure the user.
- **DO NOT** use delayed baking for highly perishable foods such as dairy products, pork, poultry, or seafood.

WARNING

- Disconnect electrical supply before servicing the appliance.
- **NEVER** use appliance door as a step stool or seat, as this may result in possible tipping of the appliance and serious injuries.
- This product should not be installed below ventilation type hood systems that directs air in a downward direction. Doing so may cause ignition and combustion problems with the gas burners resulting in personal injury and may affect the cooking performance of the unit.

SURFACE BURNERS

WARNING

- Even if the top burner flame goes out, gas is still flowing to the burner until the knob is turned to the “OFF” position. If you smell gas, immediately open a window and ventilate the area for five minutes prior to using the burner. Do not leave the burners “ON” unattended.
- **Use proper pan size - DO NOT** use pans that are unstable or that can be easily tipped. Select cookware with flat bottoms large enough to cover burner grates. To avoid spillovers, make sure the cookware is large enough to contain the food properly. This will both save cleaning time and prevent hazardous accumulations of food, since heavy spattering or spillovers left on the range can ignite. Use pans with handles that can be easily grasped and remain cool.

CAUTION

- Be sure that all surface controls are set in the “OFF” position prior to supplying gas to the range.
- **NEVER** leave the surface burners unattended at high flame settings. Boilovers may cause smoke and greasy spillovers that may catch on fire.
- Always turn the knobs to the “LITE” position when igniting the top burners and make sure the burners have ignited.
- Control the top burner flame size so it does not extend beyond the edge of the cookware. Excessive flame is hazardous.
- Only use dry pot holders—moist or damp pot holders on hot surfaces may result in burns from steam. Do not let pot holders come near open flames when lifting cookware. Do not use towels or other bulky cloth items. Use a pot holder.
- Using glass cookware—make sure the cookware is designed for top-of-range cooking.
- To prevent burns from ignition of flammable materials and spillage, turn cookware handles toward the side or back of the range without extending over adjacent burners.
- **NEVER** leave any items on the cooktop. The hot air from the vent may ignite flammable items and will increase pressure in closed containers, which may cause them to burst.
- Carefully watch foods being fried at a high flame setting.
- Always heat fat slowly, and watch as it heats.
- If frying combinations of oils and fats, stir together before heating.
- Use a deep fat thermometer if possible to prevent overheating fat beyond the smoking point.
- Use the least possible amount of fat for effective shallow or deep-fat frying. Filling the pan with too much fat can cause spillovers when food is added.
- **DO NOT** cook foods directly on an open flame on the cooktop.
- **DO NOT** use a wok on the surface burners if the wok has a round metal ring that is placed over the burner grate to support the wok. This ring acts as a heat trap, which may damage the burner grate and burner head. It may also cause the burner to work improperly. This may cause carbon monoxide levels which are higher than what is allowed by current standards, resulting in a health hazard.
- Foods for frying should be as dry as possible. Frost or moisture on foods can cause hot fat to bubble up and spillover the sides of the pan.
- **NEVER** try to move a pan of hot fat, especially a deep fat fryer. Wait until the fat is cool.
- **DO NOT** place plastic items on the cooktop—they may melt if left too close to the vent.
- Keep all plastics away from the surface burners.
- To prevent burns, always be sure that the controls for all burners are in the “OFF” position and all grates are cool before attempting to remove them.
- If you smell gas, turn off the gas to the range and call a qualified service technician. Never use an open flame to locate a leak.
- Always turn the knobs to the “OFF” position before removing cookware.
- **DO NOT** lift the cooktop. Lifting the cooktop can cause damage and improper operation of the range.
- If the range is located near a window, do not hang long curtains that could blow over the surface burners and catch on fire.

BROILER

Always use a broiler pan and a grid for excess fat and grease drainage. This will help to reduce splatter, smoke, and flare-ups. The igniter for the infrared ceramic broil burner on the ceiling of the oven will glow orange periodically during normal broil operation.

WARNING

When using your broiler, the temperature inside the oven will be extremely high. Take caution to avoid possible burns by:

- Keeping the door closed when broiling (refer to Broil section of the manual)
- Always wear oven mitts when inserting or removing food items

CAUTION

The infrared ceramic broiler will generate intense heat and will sear foods faster compared to regular bar type broilers. This broil system is designed to be operated under consumer-use conditions only. To avoid overheating and damaging the oven, do not use this broiler continuously for more than 45 minutes at a time.

Do not attempt to spray the broiler and its igniter with any type of cleaners or try to scrub it. This will damage the broiler system. The ceramic plates of your broiler do not need to be manually cleaned. Any grease or splatter on the ceramic from cooking and baking will burn clean by simply turning on your broiler for about 10 minutes.

COOK MEAT AND POULTRY THOROUGHLY

To protect against foodborne illnesses, cook meat and poultry thoroughly. The USDA has indicated the following as safe minimum internal temperatures for consumption:

- Ground beef, veal, pork, or lamb: 160 °F
- Poultry: 165 °F
- Beef, veal, pork, or lamb: 145 °F
- Fish/seafood: 145°F

SELF CLEANING OVEN

Make sure to wipe off excess spillage before operating the self clean function.

CAUTION

- **DO NOT** leave food, cooking utensils, racks, etc. in the oven during the self clean cycle.
- **DO NOT** use oven cleaners. No commercial oven cleaner or oven liner protective coating of any kind should be used in or around any part of the oven. Residue from oven cleaners will damage the inside of the oven when the self clean cycle is used.
- Remove oven racks and other items from both upper and lower ovens before starting the self clean cycle.
- Only clean the parts listed in this manual.
- **DO NOT** clean the door gasket. The door gasket is necessary for a good seal. Care should be taken not to rub, damage or move the gasket.
- If the self cleaning mode malfunctions, turn the range off and disconnect the power supply. Have it serviced by a qualified technician.
- It is normal for parts of the oven to become hot during a self clean cycle.
- Avoid touching the door, window or oven vent area during a clean cycle.

OVEN

When opening the door of a hot oven, stand away from the range. The hot air and steam that escape can cause burns to hands, face and eyes.

WARNING

NEVER block any slots, holes or passages in the oven bottom or cover an entire rack with materials such as aluminum foil. Doing so blocks air flow through the oven and may cause carbon monoxide poisoning. Aluminum foil linings may also trap heat, causing a fire hazard.

- **DO NOT** heat food in closed containers. Pressure inside the container could increase and burst, causing an injury.
- **DO NOT** use aluminum foil anywhere in the oven except as described in this manual. Doing so could create a fire hazard or cause damage to the range.
- **DO NOT** use the oven for storage. Items stored in the oven can catch on fire.
- Keep the oven free from grease buildup.
- Insert the oven racks in the desired position while the oven is cool.
- To prevent burns when removing food, slide racks out until the stop engages, then remove food items. This may also protect you from getting burnt from touching hot surfaces of the door or oven walls.
- When placing or removing a griddle, always wear oven mitts.
- When using cooking or roasting bags in the oven, follow the manufacturer's directions.
- Use only glass cookware that is recommended for use in gas ovens.
- Always remove the broiler pan from the range after you finish broiling. Grease left in the pan can catch fire if oven is used without removing the grease from the broiler pan.
- If meat is too close to the flame while broiling, the fat may ignite. Trim excess fat to prevent excessive flare-ups.
- Make sure the broiler pan is in place correctly to minimize the possibility of grease fires.
- If you should have a grease fire in the broiler pan, press the "UPPER CLEAR/OFF" or "LOWER CLEAR/OFF" key, and keep the oven door closed to contain fire until it burns out.
- For safety and better cooking performance, always bake and broil with the oven door closed. Open door baking or broiling can cause damage to the knobs or valves.
DO NOT leave the oven door open during cooking or cool down.

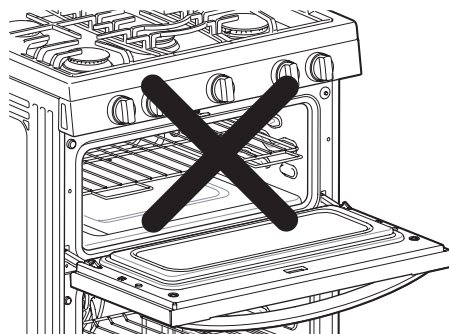

READ ALL INSTRUCTIONS BEFORE USING THE APPLIANCE.

SAVE THESE INSTRUCTIONS

BEFORE USE

Accessories

Make sure that all parts are included after purchasing this product.

Gas double oven range

Racks
(2)

Offset rack
(1)

Griddle plate
(1)

Owner's manual

Installation manual

Cooktop nozzles (5)

Oven nozzles (4)

Installation guide

LP nozzle conversion kit

Anti-tip

Screws (6)

Anchors (6)

Template

Anti-tip kit

Sold Separately

Broiler pan

Grid

NOTE

- Contact LG Customer Service if any accessories are missing.
- For your safety and extended product life, only use authorized components.
- The manufacturer is not responsible for product malfunction or accidents caused by the use of separately purchased, unauthorized components or parts.
- The images in this guide may be different from the actual components and accessories, and are subject to change by the manufacturer without prior notice for product improvement purposes.

Components

Make sure to understand the names and function of each part.

* Throughout this manual, the features and appearance may vary depending on your model.

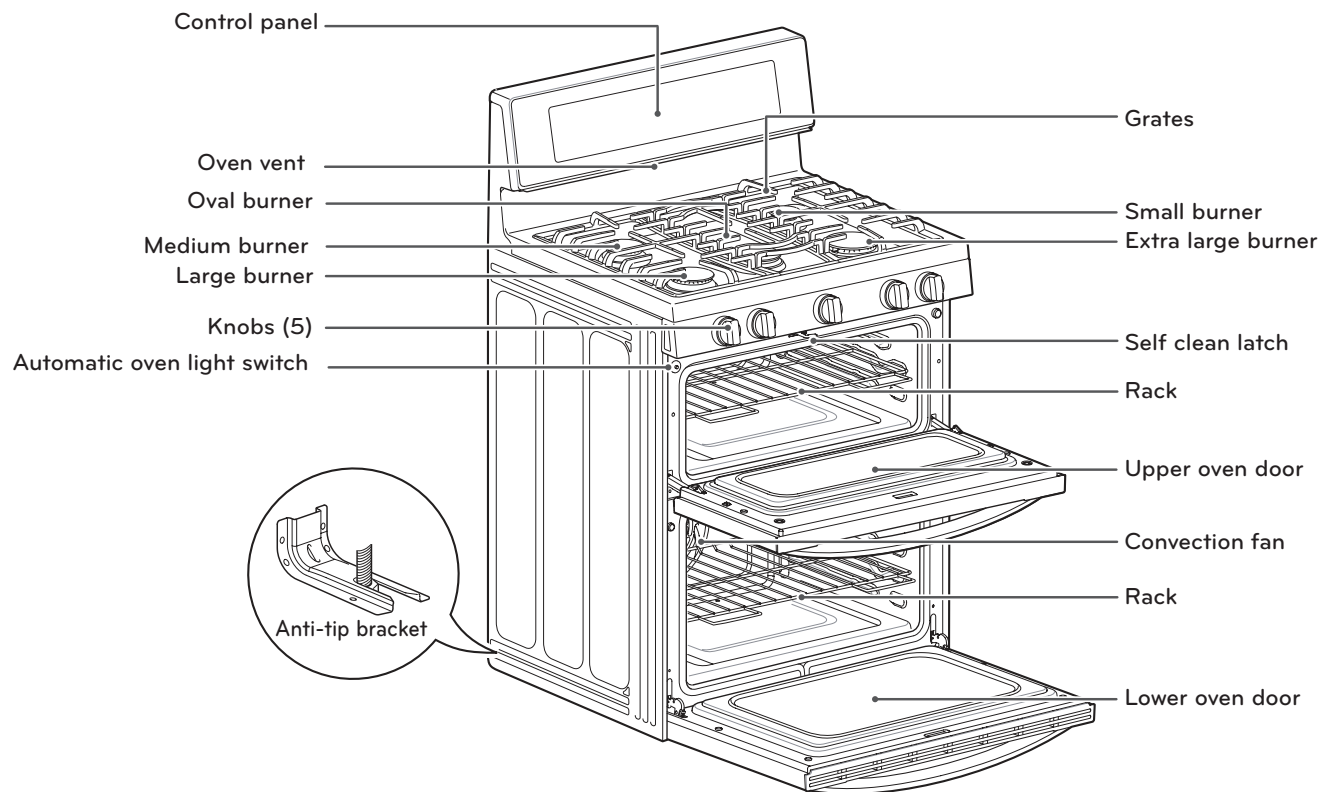

! NOTE

- The model and serial tag is located behind the control panel.

HOW TO USE

Gas Surface Burners

Before use

Read all instructions before using.

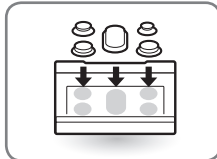

Make sure that all burners are properly placed.

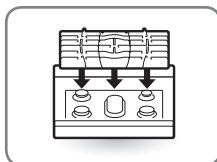

Make sure that all grates are properly placed before using the burner.



CAUTION

DO NOT operate the burner for an extended period of time without cookware on the grate. The finish on the grate may chip without cookware to absorb the heat.

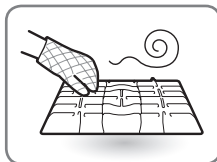

Make sure that the burners and grates are cooled down before touching them and also before placing any other object like a pot holder or a cleaning cloth, etc.

Touching grates before cooling down may cause burns.



CAUTION

WHAT TO DO IF YOU SMELL GAS

1. Open windows.
2. **DO NOT** try to light any appliance.
3. **DO NOT** touch any electrical switch.
4. **DO NOT** use any phone in your building.
5. Immediately call your gas supplier from a neighbor's phone.
Follow the gas supplier's instructions.
6. If you cannot reach your gas supplier, call the fire department.

Gas burners

Your gas range cooktop has five sealed gas burners. These can be assembled and separated. Follow the guide below.

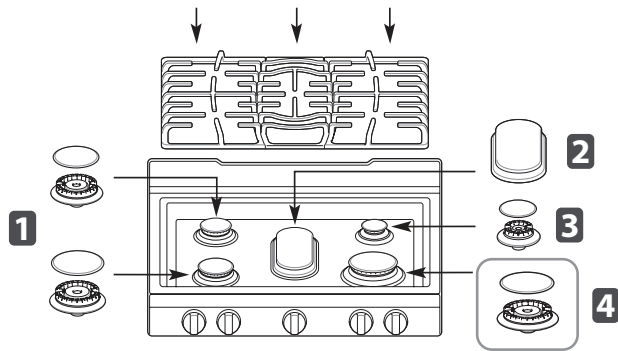

1 Medium and Large Burner

The medium and large burners are the primary burners for most cooking. These general purpose burners can be turned down from "HI" to "LO" to suit a wide range of cooking needs.

2 Oval burner

The oval burner (center) is for use with a griddle or oval pots.

3 Small Burner

The smallest burner is used for delicate foods such as sauces or foods that require low heat for a long cooking time.

4 Extra large burner

The extra large burner is the maximum output burner. Like the other four burners, it can be turned down from "HI" to "LO" for a wide range of cooking applications. This burner is also designed to quickly bring large amounts of liquid to a boil. It can be used with cookware 10 inches or larger in diameter.

Using the gas surface burners

- 1 Be sure that all of the surface burners are placed in the correct positions.
- 2 Put the cookware on the burner. (Example: pot, frying pan, etc.)
- 3 Push and turn the control knob to the "LITE" position.

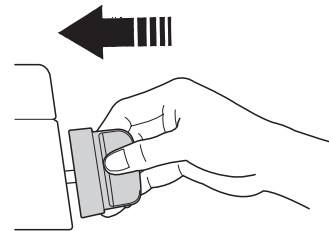

You will hear a clicking noise from the electric spark ignition system.

- 4 Turn the control knob to control the flame size.

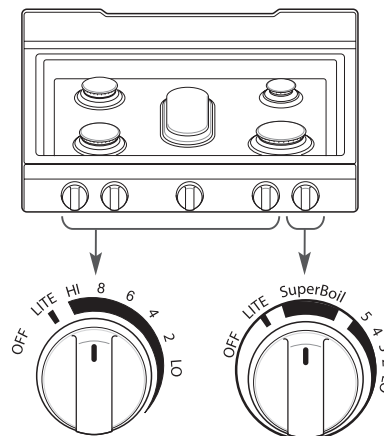

! CAUTION

DO NOT attempt to disassemble or clean around any burner while another burner is on. When turning a burner to "LITE", all the burners spark. An electric shock may result, which could cause you to knock over hot cookware.

Selecting the Flame Size

Watch the flame, not the knob, as you reduce heat. When fast heating is desired, the flame size on a gas burner should match the cookware that you are using.

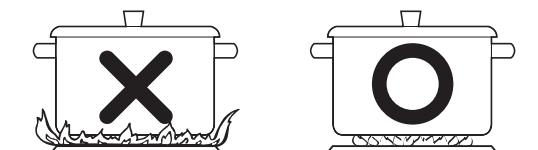

! CAUTION

NEVER let the flames extend up the sides of the cookware.

In Case of Power Failure:

In case of a power failure, you can light the gas surface burners on your range with a match.

Surface burners in use when an electrical power failure occurs will continue to operate normally.

- 1 Hold a lit match to the burner, then push in the control knob.
- 2 Turn the control knob to the "Lo" position.



CAUTION

Use extreme caution when lighting burners with a match. It can cause burn and damage.

Top-of-range cookware

Aluminum	Medium-weight cookware is recommended because it heats quickly and evenly. Most foods brown evenly in an aluminum skillet. Use saucepans with tight fitting lids when cooking with minimum amounts of water.
Cast-Iron	If heated slowly, most skillets will give satisfactory results.
Stainless Steel	This metal alone has poor heating properties and is usually combined with copper, aluminum or other metals for improved heat distribution. Combination metal skillets work satisfactorily if they are used with medium heat as the manufacturer recommends.
Enamelware	Under some conditions, the enamel of this cookware may melt. Follow cookware manufacturer's recommendations for cooking methods.
Glass	There are two types of glass cookware - those for oven use only and those for top-of-range cooking.
Heatproof Glass Ceramic	Can be used for either surface or oven cooking. It conducts heat very slowly and cools very slowly. Check cookware manufacturer's directions to be sure it can be used on gas ranges.

Using a Wok:

If using a wok, it is recommended that you use a 14-inch or smaller flat-bottomed wok. Make sure that the wok bottom sits flat on the grate.

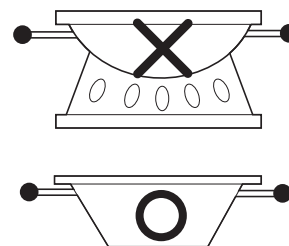

Use a flat-bottomed wok.



CAUTION

DO NOT use a wok support ring. Placing the ring over the burner or grate may cause the burner to work improperly, resulting in carbon monoxide levels above allowable standards. This can be hazardous to your health.

Using Stove-top Grills:

Do not place stove-top grills on the burner.



CAUTION

DO NOT use stove top grills on your surface burners. Using a stove top grill on the surface burner will cause incomplete combustion and can result in exposure to carbon monoxide levels above allowable current standards. This can be hazardous to your health.

Using the Griddle

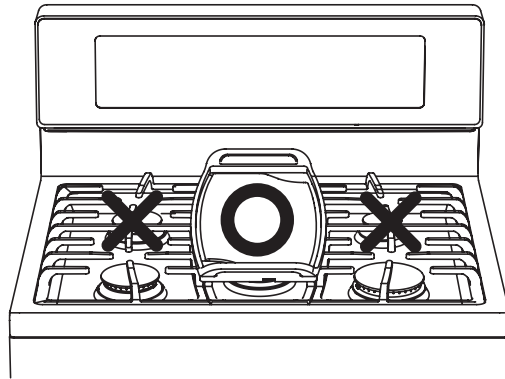

Your non-stick coated griddle provides an extra-large cooking surface for meats, pancakes or other food usually prepared in a frying pan or skillet.

! NOTE

- It is normal for the griddle to become discolored over time.

How to Place the Griddle: The griddle can only be used with the center burner. The griddle must be properly placed on the center grate, as shown in the below illustration.

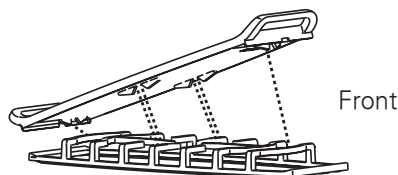

! NOTE

- **DO NOT** remove the center grate when using the griddle.

! CAUTION

DO NOT remove the griddle plate until the cooktop grates, surfaces and griddle plate are completely cooled.

! CAUTION

The griddle plate on the cooktop may become very hot when using the cooktop, oven or broiler systems. Always use oven mitts when placing or removing the griddle plate.

Preheat the griddle according to the guide below and adjust for the desired setting.

Type of Food	Preheat Conditions	Cook Setting
Warming tortillas	none	5 (MED)
Pancakes	7 (MED-HI) 3 min.	HI
Hamburgers	7 (MED-HI) 5 min.	HI
Fried Eggs	HI 5 min.	HI
Bacon	none	HI
Breakfast Sausage Links	HI 5 min.	HI
Hot Sandwiches (such as Grilled Cheese)	HI 4 min.	HI

! NOTE

- Griddle settings may need to be adjusted if the griddle is used for an extended time.

IMPORTANT NOTES:

- Avoid cooking extremely greasy foods, grease spill over can occur.
- The griddle can become hot when surrounding burners are in use.
- **DO NOT** overheat the griddle. This can damage the non stick coating.
- **DO NOT** use metal utensils that can damage the griddle surface. Do not use the griddle as a cutting board.
- **DO NOT** place or store items on the griddle.

How to Use the Oven

Before use

Read all instructions before using.

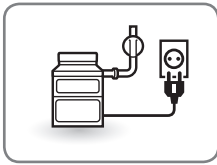

Make sure the electrical power cord and the gas valve are properly connected.

Check it for safety.



Check the correct use of the range depending on the type of food you will cook.

Make sure you know how to use the oven (temperature setting, time setting and recipe) for best results.



CAUTION

WHAT TO DO IF YOU SMELL GAS

1. Open windows.
2. **DO NOT** try to light any appliance.
3. **DO NOT** touch any electrical switch.
4. **DO NOT** use any phone in your building.
5. Immediately call your gas supplier from a neighbor's phone.
Follow the gas supplier's instructions.
6. If you cannot reach your gas supplier, call the fire department.



Choose the upper or lower oven for proper cooking.

Use the upper oven to cook a small amount of food.

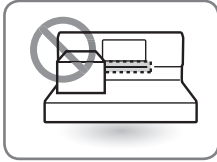

Do not block, touch or place items around the oven vent during cooking.

Your oven is vented through ducts at the center above the burner grate. Do not block the oven vent when cooking to allow for proper air flow. Do not touch vent openings or nearby surfaces during the use of any cooking operation.

CAUTION

- **DO NOT** place plastic or flammable items on the cooktop—they may melt or ignite if left too close to the vent.
- **DO NOT** place closed containers on the cooktop. The pressure in closed containers may increase, which may cause them to burst.
- Metal items will become very hot if they are left on the cooktop, and could cause burns.
- Handles of pots and pans on the cooktop may become hot if left too close to the vent.

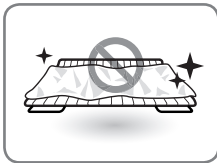

Do not cover rack or bottom with aluminum foil.

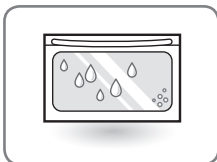

As your oven heats up, the temperature increase of the air in the oven may cause water drops to occur on the door glass.

These water drops are harmless and will evaporate as the oven continues to heat up.

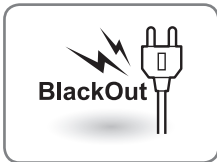

In case of power failure, do not use the oven.

The oven and broiler can not be used during a power outage. If the oven is in use when a power failure occurs, the oven burner shuts off and cannot be re-lit until power is restored. Once power is restored, you will need to reset the oven (or broil function).

CAUTION

DO NOT attempt to operate the electric ignition during an electrical power failure.

NOTE

PF (Power Failure) Message

The PF message will appear if the appliance has a power interruption. To clear the PF message, press **UPPER CLEAR/OFF** or **LOWER CLEAR/OFF** control key to reset the appliance. Be sure to also reset the clock with the correct time of day.

Using the Control Panel

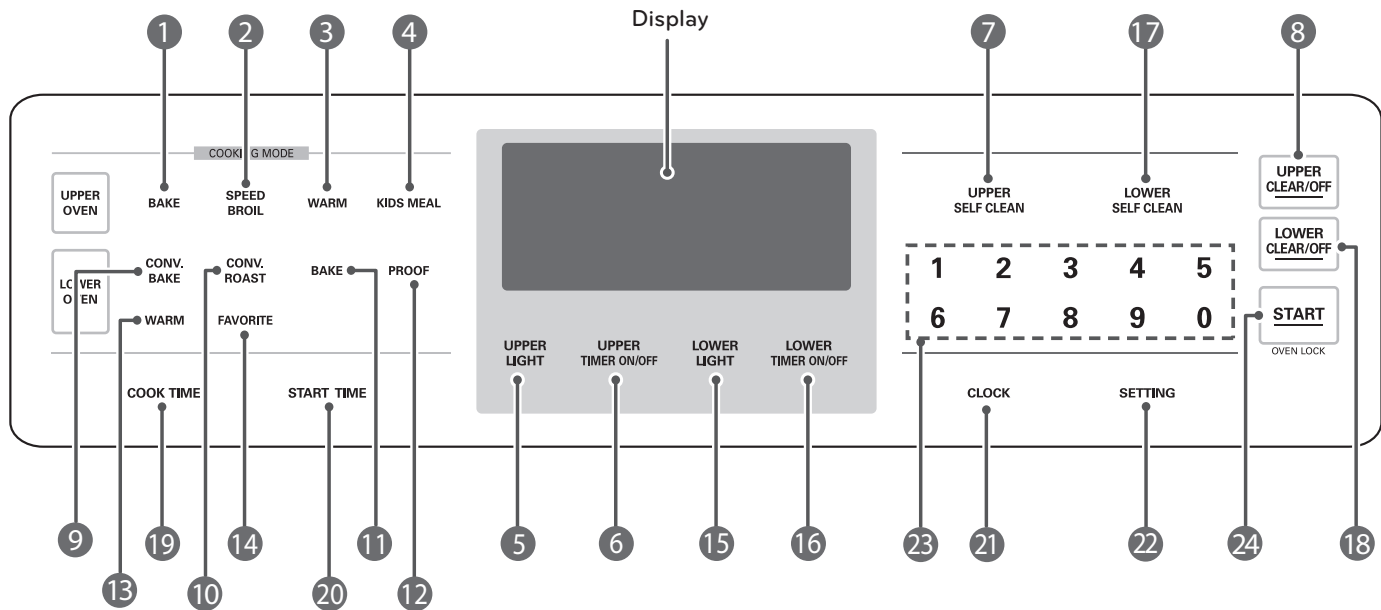

Upper Oven:

Name	Description
① BAKE	Traditional bake function. Refer to "BAKE" in the How To Use section.
② SPEED BROIL	Infrared broil function. Refer to "SPEED BROIL" in the How To Use section.
③ WARM	Warms food in the oven. Refer to "WARM" in the How To Use section.
④ KIDS MEAL	Use it cook KIDS MEAL such as frozen pizza and chicken nuggets. Refer to "KIDS MEAL" in the How To Use section.
⑤ UPPER LIGHT	Turns on/off the upper oven light.
⑥ UPPER TIMER ON/OFF	Sets, starts or cancels the timer function of the UPPER OVEN. Refer to "How to use the timer" in the How To Use section.
⑦ UPPER SELF CLEAN	Cleans the inside of the UPPER OVEN automatically. Refer to "SELF CLEAN" in the How To Use section.
⑧ UPPER CLEAR/OFF	Stops cooking or cancels the setting in the UPPER OVEN.

Using the Control Panel (continued)

Lower Oven:

Name	Description
9 CONV.BAKE	To use the Convection Baking function, Refer to "CONVECTION BAKE" in the How To Use section.
10 CONV.ROAST	To use the Convection Roast function, Refer to "CONVECTION ROAST" in the How To Use section.
11 BAKE	Traditional bake function. Refer to "BAKE" in the How To Use section.
12 PROOF	To proof bread dough. Refer to "PROOF" in the How To Use section.
13 WARM	Warms food in the oven. Refer to "WARM" in the How To Use section.
14 FAVORITE	Use it to store 3 favorite types of food. Refer to "WARM" in the How To Use section.
15 LOWER LIGHT	Turns on/off the lower oven light.
16 LOWER TIMER ON/OFF	Sets, starts or cancels the timer function of the LOWER OVEN. Refer to "How to use the timer" in the How To Use section.
17 LOWER SELF CLEAN	Cleans the inside of the LOWER OVEN automatically.
18 LOWER CLEAR/OFF	Stops cooking or cancels the setting in the LOWER OVEN.

Common Functions:

Name	Description
19 COOK TIME	Sets the cooktime length. It is automatically turned off if the desired cook time is reached.
20 START TIME	Sets the desired cooking start time. The oven automatically starts cooking at the set time.
21 CLOCK	Sets the time of the day. Refer to "How to set the clock" in the Operating Instructions section.
22 SETTING	Sets various functions.
23 NUMBER KEY	Use to set the time, timer, temperature and all times.
24 START (CONTROL LOCK)	Starts all functions except for the timer. To activate OVEN LOCK, press and hold for three seconds.

Operating Instructions

The setting value can be changed by pressing the “**SETTING**” key.

The items are different from each model. Refer to “Setting item chart”

SETTING ITEM CHART

Operating Instruction	LDG3017ST
Convection Auto Conversion	Once
Temperature Setting (Lower oven)	Twice
Temperature Setting (Upper oven)	Three times
Language	Four times
Preheating Alarm light On/off	Five times
Beeper Volume	Six times
Fahrenheit or Celsius	Seven times

How to set the convection auto conversion function for the lower oven

When using convection bake and roast, the convection auto conversion feature will automatically convert entered regular baking temperatures to convection baking temperatures. This feature is activated so that the display will show the actual converted temperature. For example, if you enter a regular recipe temperature of 350°F and touch the **START** key, the display will show the converted temperature of **325°F**.

- 1 Press the **SETTING** key once. *On Auto* will appear in the display.
- 2 Press **1** for auto conversion On, or press **2** for auto conversion Off.
- 3 Press the **START** Key to accept the change.

How to adjust the temperature settings:

You may find that your new oven cooks differently than the one it replaced. Use your new oven for a few weeks to become more familiar with it before changing the temperature settings. After familiarizing yourself with the new oven, and you still think that it is too hot or too cold, you can adjust the thermostat yourself.



CAUTION

DO NOT use thermometers, such as those found in grocery stores, to check the temperature setting of your oven. These thermometers may vary 20–40 degrees.

- 1 Determine which oven you would like to adjust (upper or lower).
- 2 Press **SETTING** key 2 times for the lower oven, *L - R J* will appear in the display.
Press **SETTING** key 3 times for the upper oven, *U - R J* will appear in the display.
- 3 Using the number keys, enter the amount of degrees that you wish to adjust the oven up or down. To adjust the temperature down, press the **SETTING** key after keying in the numbers. **Example:**

To adjust the oven temperature **up** 15 degrees, press **1, 5**.

To Adjust the oven temperature **down** 15 degrees, press **1, 5, SETTING**
- 4 Press the **START** key to accept the change.

NOTE

- This adjustment will not affect the broiling or the Self Clean temperatures. The adjustment will be retained in memory after a power failure. The oven temperature can be increased (+) or decreased (-) as much as 35°F or 19°C.
- **To decrease or increase temperature during cooking**
 1. Using the number keys, enter the new temperature.
 2. Press the **SETTING** key once.
 3. Press the **START** key to accept the choice.

How to select language

The default language of the oven's display is English. It can be changed to Spanish or French.

- 1 Press the **SETTING** key 4 times. *L n 3* (Language) will display.
- 2 Press the number key to select language.

Languages	English	Spanish	French
Number key	1	2	3

- 3 Press the **START** key to accept the change.

How to Set Preheating Alarm Light On/Off

When the oven reaches its set-temperature, the preheating alarm light will flash until the oven door is opened. You can activate or deactivate the preheating alarm light.

- 1 Press the **SETTING** key 5 times. *P - E* will display.
- 2 Press the number **1** key to select On, or press **2** to select Off.
- 3 Press the **START** key to accept the change.

How to turn the interior oven light on/off:

The interior oven light automatically turns on when the oven door is opened. Press the **UPPER LIGHT** or the **LOWER LIGHT** key to turn the oven lights on or off.

How to Adjust the Beeper Volume:

- 1 Press the **SETTING** key 6 times. **BEEP** will display.
- 2 Select **1** for loud, **2** for normal, **3** for low and **4** for mute.
- 3 Press the **START** key to accept the change.

How to select Fahrenheit or Celsius

The oven temperature settings can either be set to Fahrenheit or Celsius. The oven defaults to Fahrenheit unless changed by the user.

- 1 Press the **SETTING** key 7 times. **Unit** will display.
- 2 Press the number **1** key to select Fahrenheit, or press **2** to select Celsius.
- 3 Press the **START** key to accept the change.

How to Set the Clock (12 or 24 hour):

- 1 Hold the **CLOCK** button for 3 seconds.
- 2 Press **1** for 12 hour clock, or press **2** for 24 hour clock.
- 3 Press the **START** key.

NOTE

- The time of the day cannot be changed during a timed baking or Self Clean cycle.
- To check the time of the day when the display is showing other information, simply press the **CLOCK** key.
- If the number keys are not pressed within 30 seconds after you press the **CLOCK** key, the display reverts to the original setting. If this happens, press the **CLOCK** key and reenter the time of the day.
- If the display time is blinking, you may have experienced a power failure. Reset the time.

How to Set the Clock Time:

The clock must be set to the correct time of the day in order to the automatic oven timing functions work properly.

- 1 Press the **CLOCK** key once.
- 2 Press the number keys to select the desired time.
Example : To set 12:34, press the number keys **1, 2, 3** and **4** in that order.
- 3 Press the **START** key to accept the change.

Minimum & Maximum default settings:

All of the features listed have a minimum and a maximum time or temperature setting that may be entered into the control. An entry acceptance beep will sound each time a control key is pressed.

An entry error tone (two short tones) will sound if the entry of the temperature or time is below the minimum or above the maximum setting for the feature.

FEATURE	MIN. TEMP. / TIME	MAX. TEMP. / TIME	DEFAULT
CLOCK	12 Hr.	1:00 Hr. / Min.	11:59 Hr. / Min.
	24 Hr.	0:00 Hr. / Min.	23:59 Hr. / Min.
COOK TIME / TIMER	0:01 Min.	11:59 Hr. / Min.	
CONV. BAKE	300°F / 149°C	550°F / 288°C	325°F / 163°C
CONV. ROAST	300°F / 149°C	550°F / 288°C	325°F / 163°C
SPEED BROIL	Lo 250°F / 121°C	Hi 500°F / 260°C	High
BAKE	170°F / 77°C	550°F / 288°C	350°F / 177°C
PROOF			12 Hr.
WARM		170°F/77°C, 3 hours	3 Hr
SELF CLEAN	2 Hr.	4 Hr.	3 Hr.

How to Use the Timer

The upper or lower TIMER ON/OFF serves as an extra timer in the kitchen that will sound when the set time has run out. It does not start or stop cooking.

The upper or lower TIMER ON/OFF feature can be used during any of the other oven control functions. The upper and lower TIMER can be operated independently of each other.

1 To set minutes and seconds:

Press the **UPPER** **TIMER ON/OFF** or **LOWER** **TIMER ON/OFF** key once.

To set hours and minutes:

Press the **UPPER** **TIMER ON/OFF** or **LOWER** **TIMER ON/OFF** key twice.

2 Use the number keys to set the timer.

For Example, to set 5 minutes:

a) Press **UPPER** **TIMER ON/OFF** or **LOWER** **TIMER ON/OFF** key twice.
0:00 will appear in the display.

b) Press **5** in the number key.
0:05 will appear in the display.

3 To start the timer, press **UPPER** **TIMER ON/OFF** or **LOWER** **TIMER ON/OFF** key once. The time will count down and show in the display.

To cancel the timer before the set time has elapsed, press **UPPER** **TIMER ON/OFF** or **LOWER** **TIMER ON/OFF** (depending on which oven timer you would like to cancel).

NOTE

If **UPPER** **TIMER ON/OFF** or **LOWER** **TIMER ON/OFF** is not pressed, the timer will return to the time of day.



4 When the time is up, *End* will appear on the display and a tone will sound. The tone will sound every 5 seconds until **UPPER** **TIMER ON/OFF** or **LOWER** **TIMER ON/OFF** is pressed.

NOTE

If the remaining time is not in the display, recall the remaining time by pressing the **UPPER** **TIMER ON/OFF** or **LOWER** **TIMER ON/OFF**.

How to Use the Oven Lockout Feature

The oven lockout feature automatically locks the oven door and prevents most oven controls from being turned on. It does not disable the clock, timer or the interior oven light.

- 1 Press and hold the **START** key for three seconds. Lock A melody will sound, *OVEN LOCKOUT* will appear &  will flicker in the display. Once the oven door is locked the oven lockout indicator will stop flashing and will remain on.
- 2 To deactivate the lockout feature, press and hold the **START** key for three seconds. *UNLOCKING* will be displayed and  will flash until it is completely unlocked.

NOTE

If the lockout feature is activated with either of the doors open, the doors will not close completely until the Lockout feature is deactivated.

Removing and Replacing the Oven Racks

⚠ CAUTION

- Replace the oven rack before turning the oven on to prevent burns.
- When removing the oven racks, grab at the handles and pull out. Always wear oven mitts to prevent burns.
- **DO NOT** cover the rack with aluminum foil, or any other material, or place anything on the bottom of the oven. Doing so will result in poor baking and may damage the oven bottom.
- Only arrange oven racks when the oven is cool.

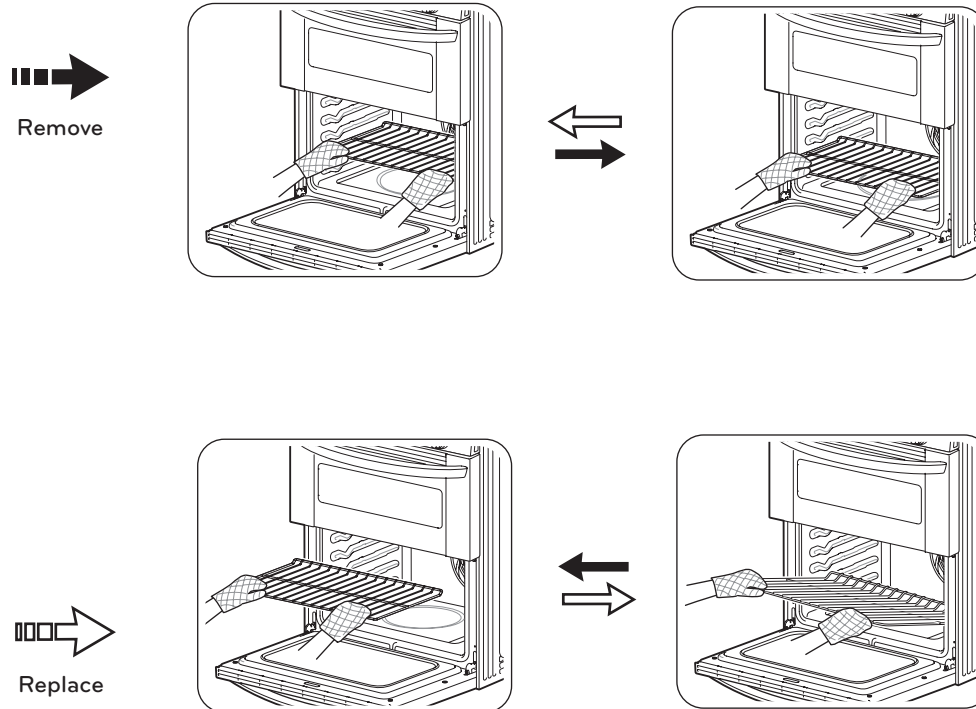

To Remove Racks

- 1 While wearing oven mitts, grasp the oven rack.
- 2 Pull the rack straight out until it stops.
- 3 Lift up the front of the rack.
- 4 Pull out the rack.

To Replace Racks

- 1 While wearing oven mitts, place the end of the rack on the support.
- 2 Tilt the front end of the rack up.
- 3 Push the rack in.
- 4 Check that the rack is properly in place.

*You can also adjust the racks position before using the oven.

BAKE (Upper & Lower Oven)

BAKE is used to prepare foods such as pastries, breads, casseroles and roasts. The oven can be programmed to bake at any temperature from 170°F (77°C) to 550°F (288°C). The default temperature is 350°F (177°C).

To set the oven to BAKE (example to 375°F):

- 1 Press the upper or lower oven **BAKE** key.
- 2 Set the oven temperature using the number keys (ex: press **3, 7, 5**).
- 3 Press the **START** key.

As the oven preheats, the temperature is displayed and rises in 5 degree increments. Once the oven reaches the desired temperature, a tone will sound and the oven light will blink on and off.

NOTE

- Preheating is necessary for better cooking results. Place the food in the oven after preheating.
- You may also change the temperature while cooking by following steps 1-3.

- 4 When cooking is complete, press the **UPPER CLEAR/OFF** or **LOWER CLEAR/OFF** key.
- 5 Remove the food from the oven.

BAKE mode display (Example)

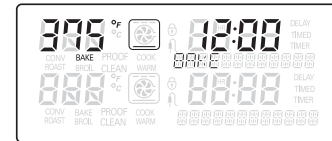

Upper oven only



Lower oven only

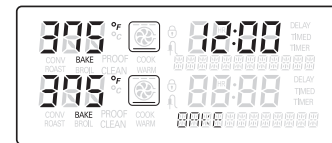

Upper & Lower oven at the same time

Preheating and Pan Placement

- To preheat, set the oven at the required recipe temperature. Wait until the oven reaches its set temperature before placing the food in the oven. Preheating is necessary for satisfactory results when baking cakes, cookies, pastries and breads.
- For best baking results, pans should be centered on the racks. If baking with more than one pan, place the pans so that each one has at least 1" to 1 1/2" of air space around them.

If cooking on multiple racks in the lower oven, place the oven racks in position C(a rack) and E(a rack). Place the cookware as shown in Fig.1.

If cooking on a single rack in the upper oven, place the oven rack in the position A and in the lower oven, place the oven rack in the position D. Place the cookware as shown in the Fig.2.

In the upper oven it is recommended to bake with the standard rack in the position A.

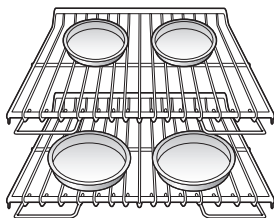

Figure 1

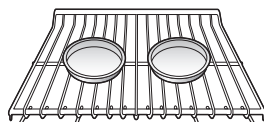
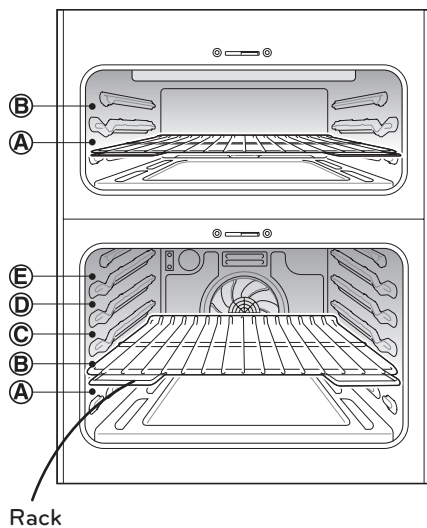

Figure 2



SPEED BROIL (Upper Oven)

Your LG gas double oven range uses an infrared (IR) ceramic broil system. Unlike a standard broil system, the IR ceramic broiler works by converting the heat of the flame into infrared energy. This system provides an intense heat that can sear foods quickly with excellent results.

Benefits of the infrared ceramic broil.

- Intense searing heat seals in juices and flavors.
- Broils foods quickly.

Your oven is designed for closed door broiling.

SPEED BROIL uses an intense heat radiation from the upper gas burner. The broil function works best when broiling, tender cuts of meat, poultry or fish.

! CAUTION

- **DO NOT** use a broiler pan without a grid. Oil can cause a grease fire.
- **DO NOT** cover the grid and broiler pan with aluminum foil. Doing so will cause a fire.
- **Always use** a broiler pan and grid for excess fat and grease drainage. This will help to reduce splatter, smoke, and flare-ups.
- **NEVER** use a broiler pan that is not thoroughly cleaned and at room temperature. If your broiler pan is damaged, warped, or has heavy permanent soiling, you should consider replacing it to reduce the amount of smoke you experience during broiling.

! NOTE

- Remove the pan from the oven to cool down for easy cleaning.
- For best results, use a pan designed for broiling, as shown below. The broiler pan will catch grease spill and the grid will help prevent grease splatters.

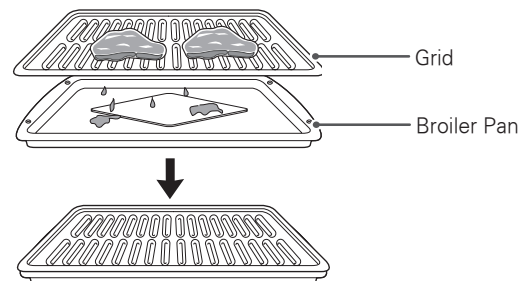

For best results, broiling should only be done with the offset rack in position 'A' in the upper oven.

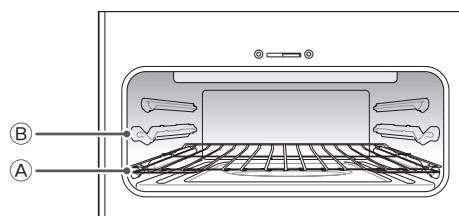

*A: The position where you use the offset rack.

! CAUTION

- Take care when sliding the offset rack in and out. It lays lower in the cavity and passes closer to hot surfaces that can cause burns. Always wear oven mitts when handling racks.

To set the upper oven to BROIL

- 1 Press the **SPEED BROIL** key once for high, twice for medium, and three times for low.
- 2 Press the **START** key.
- 3 Allow the broiler to preheat for 3 minutes.
- 4 Place food in the upper oven.
- 5 Close the oven door. The oven door must be closed during broiling.

! WARNING

When using your broiler, the temperature inside the oven will be extremely hot. Take caution to avoid possible burns by:

- Keeping the door closed when broiling
- Always wear oven mitts when inserting/removing food items
- Improper use of the broiler may result in excessive smoke or a grease fire. Improper use conditions include, but are not limited to:
 - Broiling on rack position B.
 - Setting the broiler at higher power level than recommended.
 - Using dirty/greasy broiler pans.
 - Broiling beyond recommended cooking times.

! NOTE

If the oven door remains open for more than 15 seconds during broiling, the burner will shut off. The broil burner will automatically restart once the door is closed.

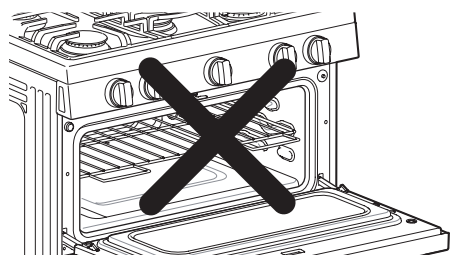

- 6 When broiling is finished, press the **UPPER CLEAR/OFF** key.

! NOTE

During any Broil function, it is normal for the broiler to cycle on and off. The igniter for the infrared ceramic broil burner on the ceiling of the oven will glow orange periodically during normal broil operation.

BROIL mode display (example)

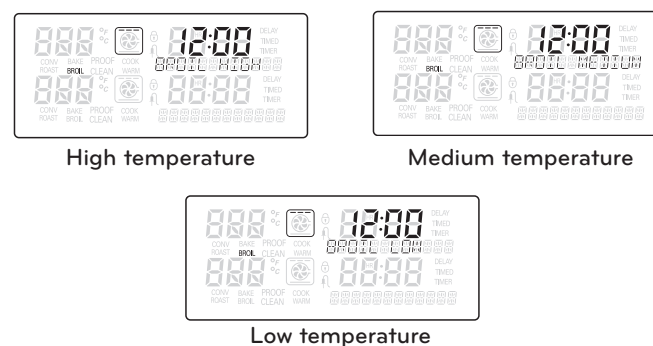

- **High:** Use High for steaks, burgers and fish for which you want to achieve deep flavorful searing.
- **Medium:** Use Medium for thicker pieces of meat that you want cooked Medium-Well or Well Done. Also use the medium broil setting for skin-on fish.
- **Low:** The Low setting is most effective for melting cheese on items such as Nachos.

Because of the intense heat associated with this infrared broiler, you may experience more smoke than you may be accustomed to compared to a conventional broiler. This smoke is a natural by product of searing and should not cause you to worry. If you are experiencing more smoke than you are comfortable with, use the following tips to reduce the amount of smoke in your oven.

1. For any broiling on High or Medium settings, use a broiler pan only. Do not use sautee pans or regular baking sheets for safety reasons.
2. NEVER use a broiler pan that is not thoroughly cleaned and at room temperature at the beginning of cooking. If your broiler pan is damaged, warped, or has heavy permanent soiling, you should consider replacing it to reduce the amount of smoke you experience during broiling.
3. ALWAYS run your cooktop ventilation system or vent hood during broiling.
4. Keep the interior of your oven as clean as possible. Leftover debris from prior meals can burn or catch fire.
5. Avoid fatty marinades and sugary glazes, both of these will increase the amount of smoke you experience. If you would like to use a glaze, apply it at the very end of cooking.
6. If you are experiencing significant smoke with any food item, consider:
 - a. Lowering the broiler to the next lowest setting.
 - b. Using the High broil setting to achieve the level of searing you desire, and then either switch to a lower broil setting, or switch to the BAKE function.
7. As a rule, fattier cuts of meat and fish will produce more smoke than leaner items.
8. Adhere to the recommended Broil settings and cooking guidelines in the chart on the following page whenever possible.

BROILING CHART

ENGLISH

Cut	Size/ Thickness	Doneness	Broiler Setting	Time		Comments
				Side 1	Side 2	
Tenderloin/Filet	1"	Medium Rare	High	5:00	3:00	<ul style="list-style-type: none"> Steaks and chops should always be allowed to rest for 5 minutes before you cut into them and begin eating. This allows the heat to distribute evenly through the food and creates a more tender and juicy result. For very thick pieces of meat, consider removing them from the fridge 30 minutes prior to cooking. This will help them cook more quickly, more evenly, and will produce less smoke. Please note that cooking times will likely be shorter than the times indicated in this above chart. For bone-in steaks or chops that have been "Frenched" (a portion of meat removed from the bone), wrap the exposed sections of bone in foil to reduce burning.
		Medium	High	5:00	4:00	
		Medium Well	High	6:00	4:00	
		Well Done	High	6:00	5:00	
	1 1/2"	Medium Rare	High	6:00	4:00	
		Medium	High	7:00	4:00	
		Medium Well	High	7:00	5:00	
		Well Done	High	7:00	6:00	
	2"	Medium Rare	High	7:00	5:00	
		Medium	High	8:00	6:00	
		Medium Well	Medium	8:00	10:00	
		Well Done	Medium	10:00	12:00	
NY Strip Steak/Striploin	3/4" - 1"	Medium Rare	High	5:00	3:00	
		Medium	High	5:00	4:00	
		Medium Well	High	6:00	4:00	
		Well Done	High	6:00	5:00	
	1 1/2"	Medium Rare	High	6:00	5:00	
		Medium	High	7:00	6:00	
		Medium Well	Medium	8:00	10:00	
		Well Done	Medium	8:00	12:00	
Ribeye/Delmonico	3/4" - 1"	Medium Rare	High	5:00	3:00	
		Medium	High	5:00	4:00	
		Medium Well	High	6:00	4:00	
		Well Done	High	6:00	5:00	
	1 1/2"	Medium Rare	High	6:00	5:00	
		Medium	High	7:00	6:00	
		Medium Well	Medium	8:00	10:00	
		Well Done	Medium	8:00	12:00	
Bone-In Steaks	3/4" - 1"	Medium Rare	High	5:00	4:00	
		Medium	High	6:00	5:00	
		Medium Well	High	7:00	6:00	
		Well Done	High	8:00	7:00	
	1 1/2"	Medium Rare	High	8:00	8:00	
		Medium	High	10:00	8:00	
		Medium Well	Medium	10:00	12:00	
		Well Done	Medium	10:00	15:00	
Skirt Steak	1/2"-3/4"	Medium Rare	High	4:00	3:00	
		Medium	High	5:00	3:00	
		Medium Well	High	5:00	4:00	
		Well Done	High	6:00	4:00	
Flank Steak	1"	Medium Rare	High	7:00	5:00	
		Medium	High	8:00	6:00	
		Medium Well	High	8:00	8:00	
		Well Done	High	9:00	9:00	
Flank Steak	1 1/2"	Medium Rare	High	8:00	6:00	
		Medium	High	8:00	8:00	
		Medium Well	High	9:00	9:00	
		Well Done	High	10:00	10:00	
Hamburgers	3/4" thick	Medium Rare	High	5:00	3:00	
		Medium	High	5:00	4:00	
		Medium Well	High	6:00	4:00	
		Well Done	High	6:00	5:00	

BROILING CHART

Cut	Size/ Thickness	Doneness	Broiler Setting	Time		Comments
				Side 1	Side 2	
Bone-in Chops	6 - 8 oz., 2 bone	Medium	High	7:00	6:00	• When broiling skin-on fish, always use the Medium broil setting and always broil the skin side last.
Salmon portion/ steak, skin-on	3/4" - 1"	Well done	Medium	6:00	4:00	
	1 1/2"	Well done	Medium	8:00 (Flesh side)	4:00 (Skin side)	
Salmon portion/ steak, skin-off	3/4" - 1"	Well done	Medium	6:00	4:00	• Seafood is best consumed immediately after cooking. Allowing seafood to rest after cooking can cause the food to dry out.
	1 1/2"	Well done	Medium	6:00	6:00	
Halibut portion, skin-off	3/4" - 1"	Well done	Medium	6:00	5:00	• It is a good idea to rub a thin coating of oil on the surface of the broiling pan before cooking to reduce sticking, especially with fish and seafood. You can also use a light coating of non-stick pan spray.
	1 1/2"	Well done	Medium	7:00	6:00	
Shrimp, skin on	<10/lb.	Well done	High	4:00	3:00	• Toss your vegetables lightly in oil before cooking to improve browning.
	10-20/lb.	Well done	High	3:00	3:00	
	21-30/lb.	Well done	High	3:00	2:00	
Shrimp, skin off	<10/lb.	Well done	High	4:00	2:00	
	10-20/lb.	Well done	High	3:00	2:00	
	21-30/lb.	Well done	High	3:00	1:00	
Lobster tail	1/3/lb.	Well done	High	6:00	Do not turn over	
Pork Chop	1"	Well done	High	6:00	5:00	
Pork Tenderloin	12-16 oz., 1.5"	Well done	High	9:00	8:00	
Sausage	1/4/lb., 1.5"	Well done	High	6:00	4:00	
Ham slices	1/2" thick	Well done	High	5:00	4:00	
Breast, boneless, skinless	1/2" - 3/4"	Well done	High	6:00	4:00	
Asparagus spears	1/2" thick	Well done	High	4:00	3:00	
Summer squash, zucchini	1/2" strips	Browning, well	High	7:00		
Toast	4 pieces	Browning, well	High	1:00	1:00	
English muffin	2 split	Browning, well	High	2:00		

This chart is only for reference. Adjust cook time according to your preference.

NOTE

- Broiling times may be affected by the size, weight, thickness, starting temperature and your preference of doneness. This guide is based on meats at refrigerated temperatures.

NOTE

The USDA advises that consuming raw or undercooked fish, meat, or poultry can increase your risk of foodborne illness. The USDA has indicated the following as safe minimum internal temperatures for consumption:

- Ground beef, veal, pork, or lamb: 160 °F
- Poultry: 165 °F
- Beef, veal, pork, or lamb: 145 °F
- Fish/seafood: 145°F

TIMED COOK (Upper & Lower Oven)

The TIMED COOK feature allows you to set the oven to cook for a specific length of time. This feature can only be used while baking.

To set TIMED COOK (example: to BAKE at 300°F for 30 minutes):

- 1 Press the upper or lower **BAKE** key. **350°F** will appear in the display.
- 2 Use the number keys to set the temperature (ex. press **3, 0, 0**).
- 3 Press **START** to begin preheating.
- 4 Once the oven has preheated to 300°, press the **COOK TIME** key. **300°F** will appear in the display.
- 5 Set the desired baking time (ex. press **3, 0**). The baking time can be set for any amount of time between 1 minute and 11 hours and 59 minutes.
- 6 Press the **START** key and the display will show the cooking time countdown.

NOTE

- To set the WARM function to engage at the end of the timed cook cycle, repeat steps 1-5 and then press the **WARM** key. WARM will appear in the display. (Refer to "WARM" in the How to Use section for more information on warming.)
- To cancel the TIMED COOK function, press **UPPER CLEAR/OFF** or **LOWER CLEAR/OFF** key at any time.

The oven will continue to cook for the set amount of time and then turn off automatically. When the cooking time has elapsed:

- **End** and the time of day will show in the display.
- The cook end indicator tone will sound every 60 seconds until the **UPPER CLEAR/OFF** or **LOWER CLEAR/OFF** key is pressed.
- When WARM is set, the warming function is activated after cooking for the time set.

To change the cook time while operating the oven: (example: to change the cook time from 30 minutes to 1 hour 30 minutes):

- 1 Press the **COOK TIME** key.

NOTE

If operating both the upper & lower oven at the same time, press the **COOK TIME** key once to set the cook time for the lower oven and twice for the upper oven.

- 2 Use the number keys to change the baking time (ex. press **1, 3, 0**).
- 3 Press **START** to accept the change.

DELAYED TIMED COOK (Upper & Lower Oven)

The automatic timer of the DELAYED TIMED COOK will turn the oven ON and OFF at the time you select. This feature can only be used for baking.

To set the oven for Delayed Start (example: to BAKE at 300°F for 30 minutes and start operating the bake mode at 4:30pm):

- 1 Be sure that the clock is set to the correct time of the day.
- 2 Arrange the interior oven rack(s) and place the food in the oven.
- 3 Press the **BAKE** key. **350°F** will appear on the display.
- 4 Use the number keys to set the oven temperature (ex. press **3, 0, 0**).
- 5 Press the **COOK TIME** key.
- 6 Set the desired baking time (ex. press **3, 0**). The baking time can be set for any amount of time from 1 minute to 11 hours and 59 minutes.
- 7 Press the **START TIME** key.
- 8 Set the desired start time (ex. press **4, 3, 0**).
- 9 Press the **START** key. At the set time, a short beep will sound and the oven will begin baking.

NOTE

- To cancel the DELAYED TIMED COOK function, press **UPPER CLEAR/OFF** or **LOWER CLEAR/OFF** key at any time.
- If you would like to change the cooking time, repeat steps 5-6 and press **START**.

The oven will continue to cook for the set amount of time and then turn off automatically. When the cooking time has elapsed:

- **End** and the time of day will show in the display.
- The cook end indicator tone will sound every 60 seconds until the **UPPER CLEAR/OFF** or **LOWER CLEAR/OFF** key is pressed.
- When WARM is set, the warming function is activated after cooking for the time set.

NOTE

If your oven clock is set as a 12 hour clock, you can delay the cook time for 12 hours. If your oven clock is set as a 24 hour clock, you can delay the cook time for 24 hours.

CAUTION

- Use the automatic timer when cooking cured or frozen meats and most fruits and vegetables. Foods that can easily spoil, such as milk, eggs, fish, meat or poultry, should be chilled in the refrigerator. Even when chilled, they should not stand in the oven for more than 1 hour before cooking begins, and should be removed promptly when cooking is completed.
- Eating spoiled food can result in sickness from food poisoning.

How to use convection for the lower oven

Convection system uses a fan to circulate the oven's heat evenly within the oven. This improved heat distribution allows for even cooking and excellent results.

CONVECTION BAKE FOR THE LOWER OVEN

Convection baking allows for even cooking and excellent results when using multiple racks at the same time. It could also shorten cooking time.

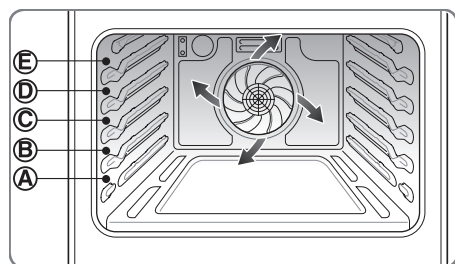

- 1 Benefits of CONVECTION BAKE
 - 1) Even bake results using multiple racks.
 - 2) Faster cooking time.

- 2 To set oven to CONVECTION BAKE (example to 375°F)
 - 1) Press the **CONV BAKE** key. The display will blink **350°F**.
 - 2) Set the oven temperature (Touch **3, 7, 5**).

NOTE

When cooking using the convection cycle, the oven temperature is automatically reduced by 25°F. The display will show the changed temperature. This feature is called "AUTO CONVERSION". Your range comes with this feature "ENABLED". To DISABLE the auto conversion feature, see "How to set convection auto conversion function" in Operating Instructions section.

NOTE

You will hear a fan while cooking with convection. The fan will stop when the door is open, but the heat will not turn off. The fan will not start until the preheat temperature is reached.

- 3) Press the **START** key. The display will show **CONV, BAKE** and the converted temperature starting at 100°F. As the oven preheats, the display will show increasing temperatures in 5 degree increments.
- 4) Once the oven reaches the desired temperature, a tone will sound and the oven light will blink on and off. The display will show the auto converted oven temperature **350°F, CONV, BAKE** and .

NOTE

- To cancel CONVECTION BAKE, touch the **LOWER CLEAR/OFF** key at any time.
- Display of the CONVECTION BAKE mode (Example)

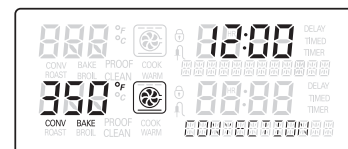

Lower oven only

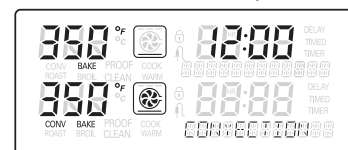

Upper & Lower oven at the same time

3 Cookware for convection cooking

Check to see if your cookware leaves room for air circulation in the oven before using your convection oven. If you are baking with several pans, leave space between them. Also, be sure the pans do not touch each other or the walls of the oven.

1) Paper and Plastic

You can use heat-resistant paper and plastic containers that are recommended for use in regular ovens in convection ovens.

2) Metal and Glass

Any type of cookware will work in your convection oven. However, metal pans heat the fastest and are recommended for convection baking.

- Darkened or matte-finished pans will bake faster than shiny pans.
- Glass or ceramic pans cook more slowly.

When baking cookies, use a flat cookie sheet instead of a pan with low sides to get the best results

For recipes like oven-baked chicken, use a pan with low sides. Hot air cannot circulate well around food in a pan with high sides.

! NOTE

- Cookies and biscuits should be baked on pans with no sides or very low sides to allow heated air to circulate around the food. Food baked on pans with a dark finish will cook faster.
- Foods cooked on a single oven rack will generally cook faster and more evenly with convection bake. Multiple oven rack cooking may slightly increase cook times for some foods, but the overall result is time saved. Breads and pastries brown more evenly.
- When cooking foods on multiple racks use the convection mode.
- The convection fan stops during convection bake cycle to allow for more even heating. This is normal.
- Use the recommended size pan in recipe.
- Some frozen foods have been developed to use commercial convection ovens. For best results in this oven, preheat the oven and use the temperature recommended in the recipe.
- If a food manufacturer gives specific convection baking package instructions, program the AUTO CONVERSION temperature so that the preheated oven temperature reads the same as the temperature on the package instructions.

CONVECTION ROAST FOR THE LOWER OVEN

CONVECTION ROAST feature is designed to give optimum roasting performance. CONVECTION ROAST feature combines cooking with the convection fan to roast meats and poultry. The heated air circulates around the food from all sides, sealing in juices and flavors.

Foods are crispy brown on the outside while staying moist on the inside.

1 To set the lower oven to CONVECTION ROAST (example to 375°F).

1) Press **CONV. ROAST** key. Display will show **350°F**.

2) Set the oven temperature (Touch **3, 7, 5**).

! NOTE

When cooking using a convection cycle the oven temperature is automatically reduced by 25°F, and then the display will show the changed temperature. This feature is called "AUTO CONVERSION". Your range comes with this feature "ENABLED". To DISABLE the auto conversion feature, see "How to set convection auto conversion function" in Operating Instructions section.

3) Press the **START** key. Display will show **CONV, ROAST** and the changing temperature starting at 100°F. As the oven preheats, the display will show increasing temperatures by 5 degree increments.

4) Once the oven reaches the desired temperature, a tone will sound and the oven light will flash on and off. The display will show the auto converted oven temperature **350°F, CONV, ROAST** and .

5) Place food in oven.

! NOTE

- Touch **LOWER CLEAR/OFF** key to cancel CONVECTION ROAST function at any time.
- Display of the CONVECTION ROAST mode (Example)

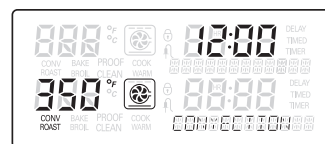

Lower oven only

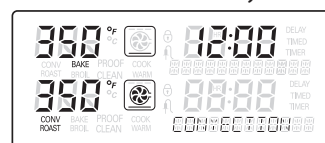

Upper & Lower oven at the same time

Special Features

KIDS MEAL (Upper Oven)

This function will preheat the upper oven to optimal temperature for cooking regular crust pizza, rising crust pizza, fresh pizza, chicken nuggets, french fries, or hamburger patties.

To set the oven KIDS MEAL:

- 1 Press **KIDS MEAL** key in upper oven. *FROZEN PIZZA, REGULAR* will appear in display.
- 2 Continue pressing **KIDS MEAL** to select *FROZEN PIZZA, RISING; FRESH PIZZA; CHICKEN NUGGETS; FRENCH FRIES; or HAMBURGER PATTIES.*
- 3 Press the **START** key. **PREHEATING** will appear on the display.
- 4 Once the oven is preheated, place the food in the oven and set the cooking time according to package direction.

Display Screen (example):



NOTE

- Preheating is necessary for better cooking results. Place the food in the oven after preheating. - Use an offset rack for kids meal cooking.

KIDS MEAL Chart

Food	Recommended Size	Shelf Position	Recommended Time (minutes)
Frozen pizza, Regular crust	12"	B	Follow package instructed times.
Frozen pizza, Rising crust	12"	B	Follow package instructed times.
Fresh pizza	12"	B	Follow package instructed times.
Chicken nuggets	1-4 servings (3.5oz per 1 serving)	B	Follow package instructed times.
French fries	1-4 servings (3.5oz per 1 serving)	B	Follow package instructed times.
Hamburger patties	4-12 patties, 1/2" thick	A	Follow package instructed times.

This chart is for reference only.

WARM (Upper & Lower Oven)

This function will maintain an oven temperature of 170°F. The **WARM** function will keep cooked food warm for serving up to 3 hours after cooking has finished. The Warm function may be used without any other cooking operations or can be used after cooking has finished using **TIMED BAKE** or **DE-LAYED TIMED BAKE**.

NOTE

- The **WARM** function is intended to keep food warm. Do not use it to cool food down.
- When the lower oven is above 475°F, the **WARM** function of the upper oven cannot be used. *Hot* will appear on the display.

To set the WARM function:

- 1 Press the **WARM** key of the upper and/or lower oven
- 2 Press the **START** key.

Display Screen (example):

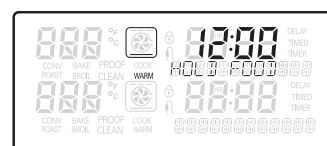

Upper oven only



Lower oven only

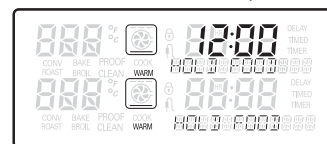

Upper & Lower oven at the same time

To set the warm function after Timed Cooking:

- 1 Set either **TIMED COOK** or **DELAYED TIMED COOK** (refer to "TIMED COOK" or "DELAYED TIMED COOK" in the How to Use section).
- 2 Press the **START** key.
- 3 Press the **WARM** key. The Warm mode is set to turn on automatically after completing the timed cooking or delayed cooking time.

NOTE

- To cancel the **WARM** function, press the **UPPER CLEAR/OFF** or **LOWER CLEAR/OFF** key at any time.
- If **UPPER CLEAR/OFF** or **LOWER CLEAR/OFF** is pressed prior to the delay functions, all cooking settings will be canceled.

PROOF (Lower Oven)

This feature maintains a warm oven for rising yeast leavened products before baking.

To set the PROOF function:

- 1 Use rack B or C for proofing.
- 2 Press the **PROOF** key.
- 3 Press the **START** key.

Display Screen (example):



Lower oven only

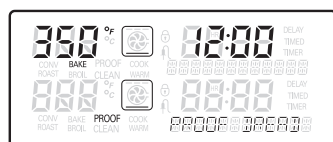

Upper & Lower oven at the same time

- 4 When proofing is finished, press the **LOWER CLEAR/OFF** key.

! NOTE

- To avoid lowering the oven temperature and lengthening proofing time, do not open the oven door unnecessarily. Check bread products early to avoid over-proofing.
- Do not use the proofing mode for warming food or keeping food hot. The proofing oven temperature is not hot enough to hold foods at safe temperatures. Use the WARM feature to keep food warm. Proofing will not operate when the oven is above 125°F. *Hot* will show in the display.

FAVORITE (Lower Oven)

This feature may store and recall up to 3 different settings. The favorite setting feature may be used with COOK TIME feature. This feature will not work with any other function including START TIME feature.

- 1 To set FAVORITE

1) Place the food in the oven.

2) Press **FAVORITE** key to select the food.

Default temperature will appear in display and **COOK** will blink.

Category how to select	Touch favorite	Default temp. (May be changed)	Operating feature
Bread	Press FAVORITE key once.	375°F	BAKE
Meat	Press FAVORITE key twice.	325°F	Convection Roast
Chicken	Press FAVORITE key 3 times.	350°F	Convection Roast

3) Press the number keys to set the desired oven temperature. This temperature will be stored and be recalled next use.

4) Press **START** key. The preheat indicator tones will sound 3 times when the oven reaches the programmed temperature.

! NOTE

- Only the temperature you selected will be stored, not the cooking time.
- If the oven temperature is changed, the changed temperature will be stored.
- The stored temperature is retained after a power failure.

SABBATH (Upper & Lower Oven)

The SABBATH mode is typically used on the Jewish Sabbath and Holidays. When the SABBATH mode is activated, the oven does not turn off until the SABBATH mode is deactivated. In SABBATH mode, all function keys, except for the **UPPER CLEAR/OFF** and **LOWER CLEAR/OFF** keys, are inactive. **5b** will appear in oven display.

NOTE

- IF the oven light is turned ON and the SABBATH mode is active, the oven light will remain ON until the SABBATH mode is turned OFF. If the oven light needs to be OFF, be sure to turn the oven light OFF before activating the SABBATH mode.
- SABBATH mode can only be used while baking (BAKE mode) in either the top, bottom, or both ovens.
- You can use TIMED COOK in another oven while either the upper oven or lower oven is activated. Refer to "TIMED COOK" in the Using Oven section.

To set the SABBATH mode:

- 1 Press the **BAKE** key.
- 2 Using the number keys, enter the desired temperature.
- 3 Press the **START** key.
- 4 Press and hold the **SETTING** key for three seconds.

Display Screen (example):

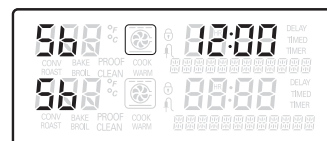

Upper oven only

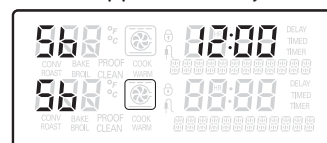

Lower oven only

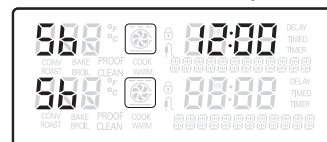

Upper & Lower oven at the same time

NOTE

- To cancel the BAKE function, press the **UPPER CLEAR/OFF** or **LOWER CLEAR/OFF** key at any time.
- To cancel the SABBATH mode, press and hold the **SETTING** key for three seconds.

To change the temperature while in SABBATH mode (no tones sound & no display change):

- 1 Press the upper or lower oven's **BAKE** key.
- 2 Using the number keys, set the desired temperature.
- 3 Press the **START** key.

NOTE

- There is a 15 second delay before the unit will recognize the temperature change.

CARE AND CLEANING

Gas Surface Burner

CAUTION

- **DO NOT** clean this appliance with bleach.
- To prevent burns, wait until the cooktop has cooled down before touching any of its parts.

Removing and Replacing the Gas Surface Burner

Grates and burner caps/heads can be removed for care and cleaning.

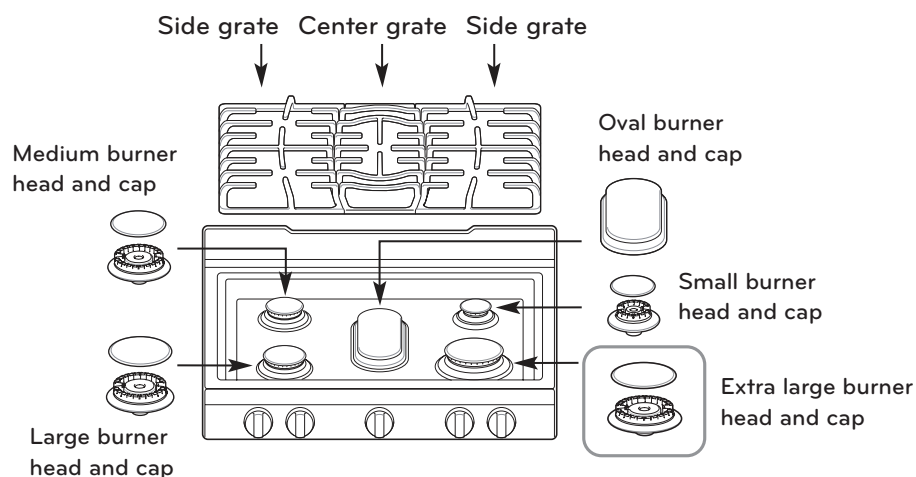

	General burner
Burner cap is properly set.	
Burner cap is NOT properly set.	

Burner Heads/Caps

For even and unhampered flame, the slits in the burner heads must be kept clean at all times. The burner heads and (the oval burner head) & Cap assembly can be lifted off.

- Wash the burner caps in hot soapy water and rinse with clean water.
- Any spills on or around an electrode must be carefully cleaned.
- To remove burnt-on food, soak the burner heads in a solution of mild liquid detergent and hot water for 20–30 minutes. For stubborn stains, use a toothbrush.
- The burners will not operate properly if the burner ports or electrodes are clogged or dirty.
- Burner caps and heads should be cleaned routinely, especially after bad spillovers.
- Burners will not light if the cap is removed.

After Cleaning the Burner Heads/Caps

Shake out any excess water and then let them dry thoroughly. Replace the burner heads and caps over the electrodes on the cooktop, in the correct locations according to their size. Make sure the hole in the burner head is positioned over the electrode.

CAUTION

- **DO NOT** hit the electrodes with anything hard. Doing so could damage them.
- **DO NOT** use steel wool or scouring powders to clean the burners.

Burner Grates

The range consists of three separate professional-style grates. For maximum stability, these grates should only be used when in their proper position. The two side grates can be interchanged from left to right and front to back. The center grate can be interchanged from front to back.

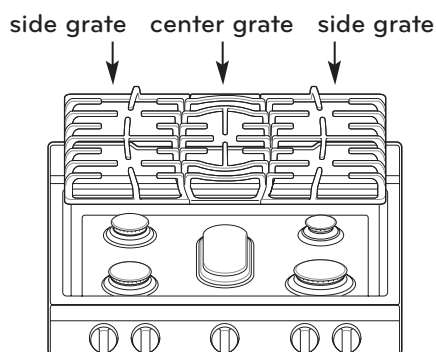

! NOTE

Do not operate a burner for an extended period of time without cookware on the grate. The finish on the grate may chip without cookware to absorb the heat.

Cleaning the Burner Grates

- Do not lift the grates out until they have cooled.
- Grates should be washed regularly and after spillovers.
- Wash the grates in hot, soapy water and rinse with clean water.
- The grates are dishwasher safe.
- After cleaning the grates, let them dry completely and securely position them over the burners.



CAUTION

DO NOT put the grate in the oven during self cleaning mode.

Cooktop Surface

To avoid burns, do not clean the cooktop surface until it has cooled. Foods with high acid or sugar content could cause a dull spot if allowed to set. Wash and rinse when the surface has cooled. For other spills such as oil/grease spattering, etc., wash with soap and water when the surface has cooled. Then rinse and polish with a dry cloth.

! NOTE

Do not lift the cooktop surface. Lifting the cooktop surface can lead to damage and improper operation of the range.

Stainless Steel Surfaces

To inquire about purchasing stainless steel appliance cleaner or polish, or to find the location of a dealer nearest you, please call our toll-free customer service number:

1-800-243-0000 or visit our website at: us.lgservice.com

! NOTE

- Do not use a steel wool pad; it will scratch the surface.
- To clean the stainless steel surface, use warm sudsy water or a stainless steel cleaner or polish.
- Always wipe in the direction of the metal surface finish.

Oven air vents

Air openings are located at the rear of the cooktop, at the top and bottom of the oven door, and at the bottom of the range.

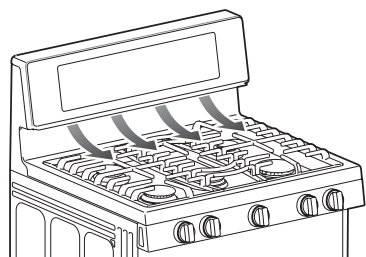

! NOTE

Do not block the vents and air openings of the range. They provide the air inlet and outlet that are necessary for the range to operate properly with correct combustion.

Control Panel

To prevent activating the control panel during cleaning, unplug the range. Clean up splatters with a damp cloth using a glass cleaner. Remove heavier soil with warm, soapy water. Do not use abrasives of any kind.

Front manifold panel and knobs

It is best to clean the manifold panel after each use of the oven. For cleaning, use a damp cloth and mild soapy water or a 50/50 solution of vinegar and water. For rinsing, use clean water and polish dry with a soft cloth.

! NOTE

- Do not use abrasive cleansers, strong liquid cleaners, plastic scouring pads or oven cleaners on the manifold panel. Doing so will damage the finish.
- Do not try to bend the knobs by pulling them up or down or by hanging a towel or other objects on them. This can damage the gas valve shaft.
- The control knobs may be removed for easy cleaning.
- To clean the knobs, make sure that they are in the "OFF" position and pull them straight off the stems.
- To replace the knobs, make sure the knob has the "OFF" position centered at the top, and slide the knob directly onto the stem.

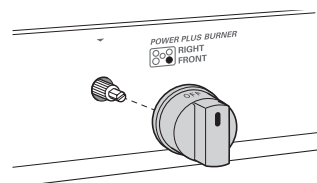

! NOTE

To prevent scratching, do not use abrasive cleaners on any of these materials.

Oven Door

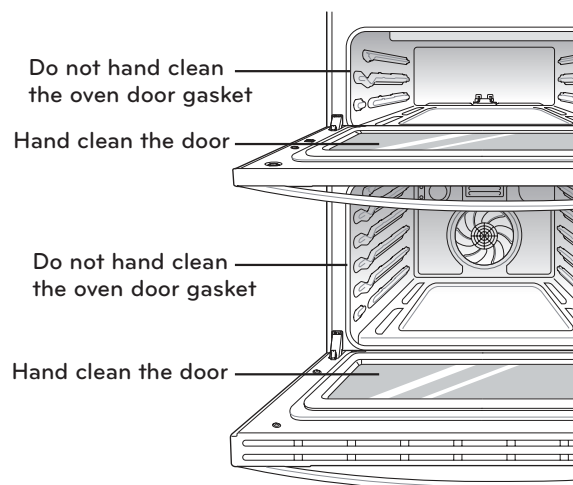

- Use soapy water to thoroughly clean the oven door. Rinse well. **DO NOT** immerse the door in water.
- You may use a glass cleaner on the outside glass of the oven door. **DO NOT** spray water or glass cleaner on the door vents.
- **DO NOT** use oven cleaners, cleaning powders, or harsh abrasive cleaning materials on the outside of the oven door.
- **DO NOT** clean the oven door gasket. The oven door gasket is made of a woven material that is essential for a good seal. Care should be taken not to rub, damage, or remove this gasket.

NOTE

Do not use cleaners or harsh abrasive cleaning materials on the outside of the oven door. Doing so can cause damage.

Removing and replacing the doors

Do not close the oven door until all of the oven racks are completely in place.

CAUTION

- Be careful when removing and lifting the door.
- **DO NOT** lift the door by the handle.
- **DO NOT** hit the glass with pots, pans, or any other object.
- Scratching, hitting, jarring or stressing the glass may weaken its structure, causing an increased risk of breakage at a later time.

Removing the Upper Oven Door

- 1 Fully open the door. Lift up the hinge locks toward the oven frame until they stop.

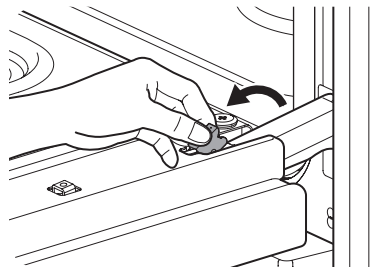

- 2 Close the door to approximately 30 degrees.

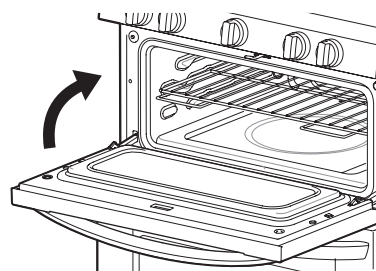

- 3 Press down the release buttons on each hinge on both sides of the door.

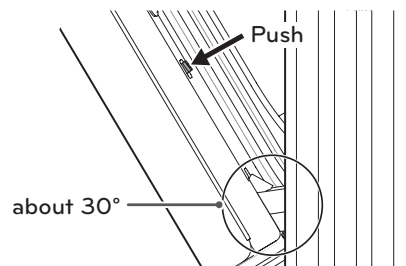

- 4 Lift up the door until it is clear off the hinge.

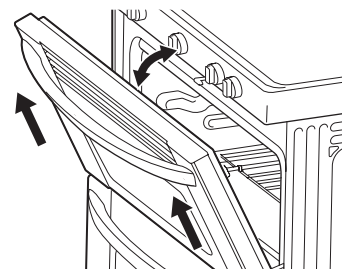

Replacing the Upper Oven Door

- 1 Be sure that the hinges are lined up at a 30 degree position.

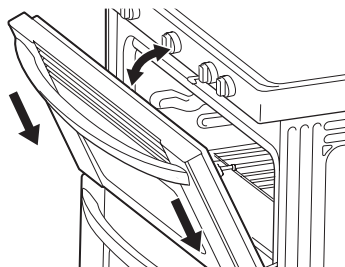

- 2 Slide the door back into the hinges until you hear a solid click and the release buttons have engaged.

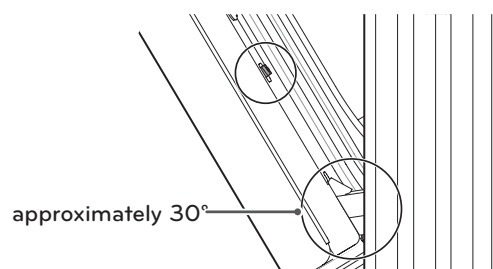

- 3 Fully open the door. Push the hinge locks down onto the hinge.

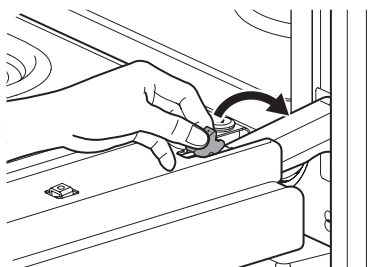

- 4 Close the oven door.

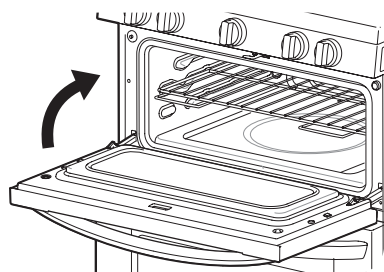

Removing the Lower Oven Door

- 1 Fully open the door. Lift up the hinge locks toward the oven frame until they stop.

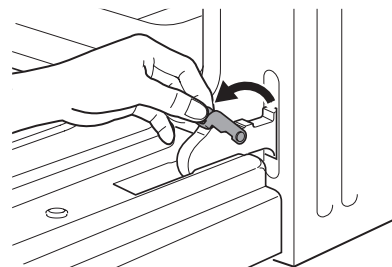

- 2 Close the door to the removal position (approximately five degrees).

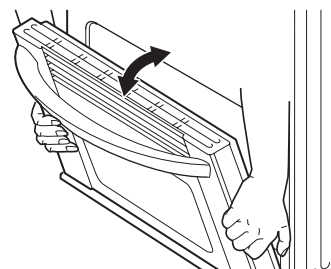

- 3 Lift the door up and out until the hinge arm is clear off of the slot. Put the door on the floor.

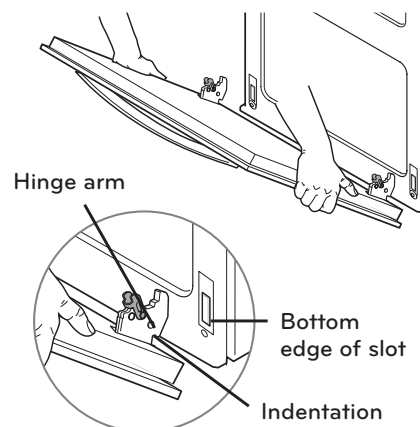

Replacing the Lower Oven Door

- 1 Firmly grasp both sides of the door at the top and close the door to the removal position (approximately five degrees).

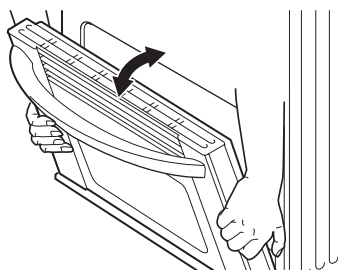

- 2 Seat the indentation of the hinge arm into the bottom edge of the hinge slot.

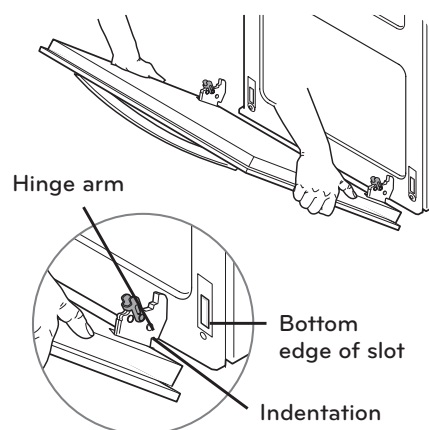

- 3 Open the door to its full extension. Push the hinge locks down against the front frame of the oven cavity to the locked position. Close the oven door.

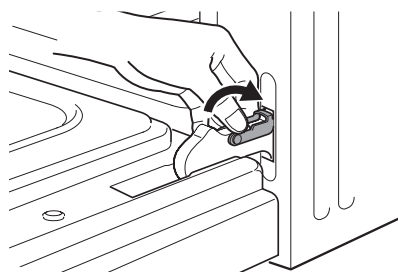

NOTE

If the door will not fully open, the indentation is not seated correctly in the bottom edge of the slot.

Inside of the Oven

Cleaning Guide

Soil Level	Cycle Setting
Lightly Soiled Oven Cavity	2 Hour Self Clean (p. 40)
Moderately Soiled Oven Cavity	3 Hour Self Clean (p. 40)
Heavily Soiled Oven Cavity	4 Hour Self Clean (p. 40)

SELF CLEAN (Upper & Lower Oven)

The SELF CLEAN cycle uses above normal cooking temperatures to clean the oven cavity. You may see some smoke and smell an odor the first few times the oven is cleaned. This is normal and will lessen in time. Smoke may also occur if the oven is heavily soiled. During self clean, the kitchen should be well ventilated to minimize the odors from cleaning. The upper and lower oven SELF CLEAN cannot be operated simultaneously.

CAUTION

- **DO NOT leave small children unattended near the appliance.** During the self cleaning cycle, the outside of the range can become very hot to the touch.
- **If you have a pet bird, move it to another well-ventilated room.** Some birds are extremely sensitive to the fumes given off during the self cleaning cycle of any range.
- **DO NOT wrap the oven walls, racks, bottom or any other part of the range with aluminum foil or any other material.** Doing so will destroy the heat distribution, produce poor baking results, and cause permanent damage to the interior of the oven (aluminum foil will melt to the interior surface of the oven).
- **DO NOT force the door open.** This can cause damage to the automatic door locking system. Use care when opening the oven door after the Self Cleaning cycle. Stand to the side of the oven when opening the door to allow hot air or steam to escape. The oven may still be very hot.
- **Never touch the broil element.** It can cause burns if it is not cooled completely. The broiler is self cleaning and touching it can damage the broiler.

Before Starting SELF CLEAN

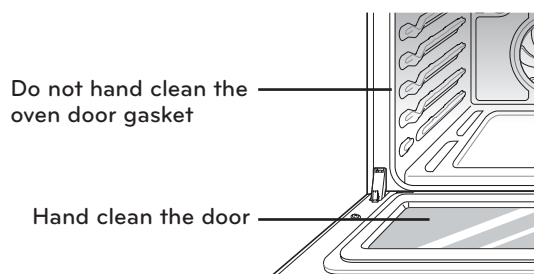

- Remove the oven racks, broiler pan, broiler grid, all cookware, aluminum foil or any other material from the oven.
- The kitchen should be well ventilated to minimize the odors from cleaning.
- If running a self clean in one of the ovens, the other oven can not be used.
- Wipe any heavy spillovers on the bottom of the oven.
- Make sure that the oven light bulb cover is in place and the oven light is off.
- The oven light cannot be turned on during a self clean cycle. The oven light cannot be turned on until the oven temperature has cooled below 500°F (260°C) after a self clean cycle is complete.
- Fine lines may appear in the porcelain because it went through heating and cooling. This is normal and will not affect performance.

NOTE

- Clean the frame of the oven and door with hot soapy water. Rinse well.
- Do not clean the oven door gasket. The oven door gasket is made of a woven material that is essential for a good seal. Care should be taken not to rub, damage, or remove this gasket.
- Do not open the oven door until the self clean cycle is complete.
- The oven door can become extremely hot. Do not touch the oven door until it has cooled down.
- You may see some smoke and smell an odor the first few times the oven is cleaned. This is normal.
- As the oven heats, you may hear sounds of metal parts expanding and contracting. This is normal.
- A self clean cycle cannot be started if the Oven Lock-out feature is active.

To Set Self Clean

- 1 Press **UPPER SELF CLEAN** or **LOWER SELF CLEAN** key.
The oven defaults to the recommended three hour self clean for a moderately soiled oven. Press twice for a four hour self clean and three times for a two hour self clean.
- 2 Press the **START** key.

Once the self clean is set, the oven door will lock automatically and **L** will display. You will not be able to open the oven door until the oven is cooled. The lock will release automatically when the oven has cooled.

CAUTION

DO NOT force the oven door open when **L** is displayed. The oven door will remain locked until the oven temperature has cooled. Forcing the door open will damage the door.

To Set Self Clean with a Delayed Start

(example: set for 3:00 AM/PM)

- 1 Press **UPPER SELF CLEAN** or **LOWER SELF CLEAN** key.
The oven defaults to the recommended three hour self clean for a moderately soiled oven. Press twice for a two hour self clean and three times for a four hour self clean.
- 2 Press the **START TIME** key.
- 3 Use the keypad to enter in the time of day that you would like the oven to start the Self Clean cycle (ex. **3, 0, 0**).

NOTE

The Delayed Self Clean start time can only be set 11 hours and 59 minutes ahead. To set for 12- 24 hours in advance, see "How to change hour mode on clock."

- 4 Press the **START** key

Once the self clean is set, the oven door will lock automatically and **L** will display. You will not be able to open the oven door until the oven is cooled. The lock will release automatically when the oven has cooled.

NOTE

It may become necessary to cancel or interrupt a self clean cycle due to excessive smoke or fire in the oven. To Cancel the Self Clean function, press the **UPPER CLEAR/OFF** or **LOWER CLEAR/OFF** key.

After Self Clean

- You may notice some white ash in the oven. Wipe it off with a damp cloth after the oven cools.
- If the oven is not clean after one clean cycle, repeat the clean cycle.
- If the oven racks were left in the oven and do not slide smoothly after a clean cycle, wipe racks and rack supports with a small amount of vegetable oil to make them glide easier.

Changing the Oven Light

The oven light is a standard 40-watt appliance bulb. It will turn on when the oven door is open. When the oven door is closed, press the **UPPER LIGHT** or **LOWER LIGHT** key to turn the light on or off.

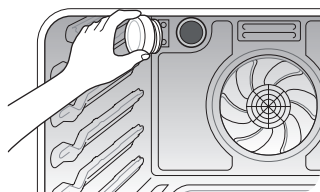

To replace the oven light

- 1 Unplug the range or disconnect power.
- 2 Turn the glass bulb cover in the back of the oven counterclockwise to remove.
- 3 Turn the bulb counterclockwise to remove from socket.
- 4 Insert the new bulb and turn it clockwise.
- 5 Insert the glass bulb cover and turn it clockwise.
- 6 Plug in the range or reconnect the power.

! WARNING

- Make sure that the oven and bulb are cool.
- DISCONNECT the electrical power to the range at the main fuse or circuit breaker panel. Failure to do so can result in severe personal injury, death, or electrical shock.

Broiler Pan and Grid (sold separately)

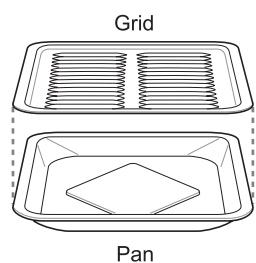

! NOTE

Remove the broiler pan and grid from the oven before operating the self clean cycle.

- 1 After broiling, remove the broiler pan from the oven. Remove the grid from the pan.
- 2 Carefully pour out the grease from the pan into a proper container.

- 3 Wash and rinse the broiler pan and grid in hot water with a soap-filled or plastic scouring pad. If food has burnt on, sprinkle the grid with cleaner (while hot) and cover it with wet paper towels or a dishcloth. Soaking the pan will remove burnt-on foods. Both the broiler pan and grid may be cleaned with a commercial oven cleaner. Both the broiler pan and grid can also be cleaned in a dishwasher.

Oven racks

Remove the oven racks before operating the self clean cycle.

- 1 Food spilled into the tracks could cause the racks to become stuck. Clean with a mild, abrasive cleaner.
- 2 Rinse with clean water and dry.

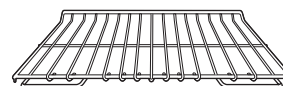

! NOTE

If the racks are cleaned using the self clean cycle (not recommended), the color will turn slightly blue and the finish will become dull. After the self clean cycle is complete, and the oven has cooled, rub the sides of the racks with wax paper or a cloth containing a small amount of oil. This will make the racks glide easier into the rack tracks.

BEFORE REQUESTING SERVICE

Symptoms and Questions	Possible Cause/Solution
Top burners do not light or do not burn evenly.	<ul style="list-style-type: none"> • Make sure that the electrical plug is inserted into a live, properly grounded outlet. • Remove the burners and clean them. Check the electrode area for burnt-on food or grease. See "Burner caps/burner head cleaning" in the Care and Cleaning section. • Make sure that the burner parts are installed correctly. See "Burner caps/heads cleaning" in the Care and Cleaning section.
Burner flames are very large or yellow.	If the range is connected to LP gas, contact the technician who installed your range or made the conversion.
Surface burners light but the oven does not.	Make sure that the oven gas shut-off valve, located behind the range, is fully open.
Food does not bake or roast properly.	<ul style="list-style-type: none"> • Incorrect oven control settings. See "Using control panel" in the How to Use section. • Incorrect rack position. See "Replace and remove Oven rack" or "Shelf position Baking time" in the How To Use section. • Incorrect cookware is being used. See "Roast" or "Bake" in the How To Use Section. • Oven thermostat needs adjustment. See "How to adjust the temperature" in the Operating Instructions section. • The Clock is not set correctly. See "How to set the clock and the timer" in the Operating Instructions section. • Aluminum foil used improperly in the oven. See "Using the oven."
Food does not broil properly in the oven.	<ul style="list-style-type: none"> • Incorrect oven control settings. See "Using control panel" in the How to Use section. • The oven door is not closed. See "Using the oven" in the How to Use section. • Aluminum foil used on the broiling pan and grid is not fitted properly.
Oven temperature is too hot or too cold.	The oven thermostat needs adjustment. See "How to adjust the temperature" in the Operating Instructions section.
Clock and timer does not work.	<ul style="list-style-type: none"> • Make sure the electrical plug is inserted into a live, properly grounded outlet. Replace the fuse or reset the circuit breaker. • Improper oven control settings. See "How to set the clock and the timer" in the Operating Instructions section.
Oven light does not work.	<ul style="list-style-type: none"> • The light bulb is loose or defective. Tighten or replace the bulb. • The plug on the range is not completely inserted in the electrical outlet. Make sure the electrical plug is inserted into a live, properly grounded outlet.
Self clean is not working.	<ul style="list-style-type: none"> • The oven temperature is too high to set a self clean operation. Allow the range to cool down to room temperature and reset the controls. • Improper oven control settings. See "SELF CLEAN" in the Care and Self Cleaning section.
"Crackling" or "popping" sound.	This is the sound of the metal heating up and cooling down during both the cooking and cleaning functions. This is normal.

Symptoms and Questions	Possible Cause/Solution
Too much smoke during the self clean cycle.	Too much soil in the oven. Open the windows to get rid of the smoke from the room. Press the ^{UPPER} CLEAR/OFF or ^{LOWER} CLEAR/OFF key. Wait until the  light goes off before trying to open the oven door. Wipe up the excess soil and reset the clean cycle.
The oven door does not open after a self clean cycle.	The oven temperature is too high. Wait up to one hour to cool down.
The oven door is not clean after a self clean cycle.	<ul style="list-style-type: none"> • Incorrect oven control settings. See "SELF CLEAN" in the Care and Cleaning section. • The oven was heavily soiled. Clean up heavy spills before beginning the self clean cycle. Heavily soiled ovens may need either a longer self clean or two self clean cycles.
"CLOSE DOOR TO CONTINUE BROILING" or "DOOR OPENED" appears in the display.	Close the oven door.
"DOOR LOCKED" message appears when you want to cook.	The oven door is locked because the temperature inside of the oven is too high. Press the ^{UPPER} CLEAR/OFF or ^{LOWER} CLEAR/OFF key.
Oven control beeps and displays an F error code.	<ul style="list-style-type: none"> • Press the ^{UPPER}CLEAR/OFF or ^{LOWER}CLEAR/OFF key and wait for one hour. • Check the main gas shut-off valve or the oven gas shut-off valve and call for service. • Remove the power from the range for five minutes and then reconnect the power. If the function error code repeats, call for service.
The oven racks were cleaned in a self clean cycle.	Apply a small amount of vegetable oil to a paper towel and wipe the edges of the oven racks. Do not use lubricant sprays.
Clock is flashing.	Power outage or surge. Reset the clock. If the oven was in use, you must reset it by pressing the ^{UPPER} CLEAR/OFF or ^{LOWER} CLEAR/OFF key. Reset the clock and any cooking function.
"Burning" or "oily" odor emitting from the vent.	This is normal in a new oven. To speed the process, set a self clean cycle for a minimum of three hours. See "SELF CLEAN" in the Care and Cleaning section.
Strong odor.	An odor from the insulation around the inside of the oven is normal for the first few times the oven is used.
Fan noise	The convection fan may turn on and off automatically. This is normal.
Convection fan not working.	The preheating temperature has not been reached. The Fan will start automatically once the preheating temperature is reached.
Burners are not lighting properly after cleaning the cooktop surface.	Make sure that the burner heads and caps are completely dry and properly positioned.

WARRANTY

LG Electronics Inc. will repair or replace your product, at LG's option, if it proves to be defective in material or workmanship under normal use, during the warranty period set forth below, effective from the date of original consumer purchase of the product. This limited warranty is good only to the original purchaser of the product and effective only when used in U.S.A.

WARRANTY PERIOD	HOW SERVICE IS HANDLED
One Year From the date of the original purchase.	Any part of the oven that fails due to a defect in materials or workmanship. During this full one-year warranty , LG will also provide, free of charge , all labour and in-home service to replace the defective part.

THIS WARRANTY IS IN LIEU OF ANY OTHER WARRANTIES, EXPRESS OR IMPLIED, INCLUDING WITHOUT LIMITATION, ANY WARRANTY OF MERCHANTABILITY OR FITNESS FOR A PARTICULAR PURPOSE. TO THE EXTENT ANY IMPLIED WARRANTY IS REQUIRED BY LAW, IT IS LIMITED IN DURATION TO THE EXPRESS WARRANTY PERIOD ABOVE. LG WILL NOT BE LIABLE FOR ANY CONSEQUENTIAL, INDIRECT, OR INCIDENTAL DAMAGES OF ANY KIND, INCLUDING LOST REVENUES OR PROFITS, IN CONNECTION WITH THE PRODUCT. SOME STATES DO NOT ALLOW LIMITATION ON HOW LONG AN IMPLIED WARRANTY LASTS OR THE EXCLUSION OF INCIDENTAL OR CONSEQUENTIAL DAMAGES, SO THE ABOVE LIMITATIONS OR EXCLUSIONS MAY NOT APPLY TO YOU.

THIS LIMITED WARRANTY DOES NOT APPLY TO:

1. Service calls to correct the installation of your appliance, to instruct you how to use your appliance, to replace house fuses or correct house wiring, or to replace owner-accessible light bulbs.
2. Repairs when your appliance is used in other than normal, single-family household use.
3. Pickup and delivery. Your appliance is designed to be repairable in the home.
4. Damage resulting from accident, alteration, misuse, abuse, fire, flood, improper installation, acts of God, or use of products not approved by LG Corporation.
5. Repairs to parts or systems resulting from unauthorized modifications made to the appliance.
6. Replacement parts or repair labour costs for units operated outside the united states.
7. Any labour costs during the limited warranty period.

This warranty is extended to the original purchaser for products purchased for home use within the U.S.A. In Alaska, the warranty excludes the cost of shipping or service calls to your home.

Some states do not allow the exclusion or limitation of incidental or consequential damages, so this exclusion or limitation may not apply to you. This warranty gives you specific legal rights, and you may also have other rights which vary from state to state. To know what your legal rights are, consult your local or state consumer affairs or your state's Attorney General.

CUSTOMER ASSISTANCE INFORMATION:

To Prove Warranty Coverage	Retain your Sales Receipt to prove date of purchase. A copy of your Sales Receipt must be submitted at the time warranty service is provided.
To Obtain the Nearest Authorized Service Center or Sales Dealer, or to Obtain Product, Customer, or Service Assistance	Call 1-800-243-0000 (Phone answered 24 hours - 365 days a year) and choose the appropriate prompt from the menu; or visit our website at: http://us.lgservice.com .

MEMO



LG Customer Information Center

1-800-243-0000 USA, Consumer User

1-888-865-3026 USA, Commercial User

Register your product Online!

www.lg.com