

BLACK+ DECKER™

PORTABLE DEHUMIDIFIER

INSTRUCTION MANUAL

CATALOG NUMBER

BDT30**

BDT45**

BDT70**

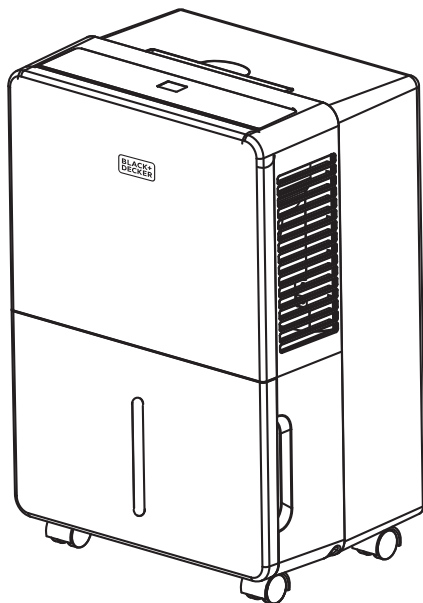

Thank you for choosing BLACK+DECKER!

PLEASE READ BEFORE RETURNING THIS PRODUCT FOR ANY REASON.

If you have a question or experience a problem with your BLACK+DECKER purchase, go to www.blackanddecker.com/instantanswers

If you can't find the answer or do not have access to the Internet, call 844-299-0879 from 10:30 a.m. to 6:30 p.m. EST Mon. - Fri. to speak with an agent. Please have the catalog number available when you call.

SAVE THIS MANUAL FOR FUTURE REFERENCE.

CONTENTS

SAFETY INFORMATION

Important Safety Instructions.....	3-4
Grounding Instructions.....	4
Safety Guidelines	4
Power Cord Operation.....	4

SET UP & USE

Parts & Features	5
Control Panel.....	6
Installation Guide	7
Before First Operation.....	8
Operation Instructions.....	9-13
Specifications	14

CLEANING & CARE.....	15
----------------------	----

TROUBLE SHOOTING & WARRANTY

Before You Call For Service.....	16
Customer Service.....	16
Troubleshooting.....	17
Limited Warranty.....	18

PRODUCT REGISTRATION

Thank you for purchasing our BLACK+DECKER product. This easy-to-use manual will guide you in getting the best use of your portable dehumidifier.

Remember to record the model and serial numbers. They are on a label on the rear.

Model number

Serial number

Date of purchase

Staple your receipt to your manual. You will need it to obtain warranty service.

SAFETY INFORMATION



DANGER

DANGER - Immediate hazards which **WILL** result in severe personal injury or death



WARNING

WARNING - Hazards or unsafe practices which **COULD** result in severe personal injury or death



CAUTION

CAUTION - Hazards or unsafe practices which **COULD** result in minor personal injury

IMPORTANT SAFETY INSTRUCTIONS



WARNING

When using electrical appliances, basic safety precautions should be followed, including the following

1. Always place the unit on a level surface strong enough to support the unit with a full bucket of water
2. Never use or store gasoline or other flammable vapor or liquid near this unit
3. Maintain at least 12-18 inches clearance space around this unit. Do not block or cover air inlet or outlet grills.
4. The unit must be connected to a correctly grounded power supply.
5. Do not start or stop the unit by inserting or pulling out the power plug.
6. Do not use an adapter plug or extension cord.
7. Do not use the unit in the immediate surroundings of a bath, a shower, swimming pool, or clothes dryer.
8. Do not insert anything into the air outlet.
9. Do not let children play near this unit.
10. Always inspect the cord for signs of damage before use. If the power cord is damaged, it must be replaced by the manufacturer or a qualified service technician.
11. When cleaning the unit, always turn the unit off and unplug the power cord.
12. Do not use outdoors. Intended for indoor use only.
13. Place the dehumidifier in an area where the temperature will not fall below 41° Fahrenheit. The coils can become covered with frost, which may reduce performance.

SAVE THESE INSTRUCTIONS
HOUSEHOLD USE ONLY

SAFETY INFORMATION

GROUNDING INSTRUCTIONS

ELECTRICAL REQUIREMENTS

The electrical requirements are a 115 volt 60 Hz, dehumidifier only, 15 amp. It is recommended that a separate circuit serving only the product be provided. The product is equipped with a 3-wire cord having a 3-prong grounding plug. It must be plugged into a wall receptacle that is properly installed and grounded.

This appliance must be grounded. In the event of an electrical short circuit, grounding reduces risk of electric shock by providing an escape wire for the electric current. The cord provided with this appliance is equipped with a grounding wire and a grounding plug. The plug must be plugged into an outlet that is properly installed and grounded.

Avoid the use of three prong adapters or cutting off the third grounding prong in order to accommodate a two prong outlet. This is a dangerous practice since it provides no effective grounding for the air conditioner and may result in shock hazard.

WARNING

Improper use of the grounding plug can result in a risk of electric shock.

Consult a qualified electrician or serviceman if:

- 1) The grounding instructions are not completely understood.
- 2) You are unsure that the appliance is properly grounded.
- 3) You have any questions about the grounding or electrical instructions.

POWER SUPPLY CORD

1. Avoid the use of an extension cord because of potential safety hazards under certain conditions. Have a qualified electrician or serviceman to install an outlet near the appliance.
2. If it is absolutely necessary to use longer cord sets or an extension cord, extreme care must be exercised.
 - a) Use only a grounding type 3-wire extension cord that has a 3-blade grounding plug and a 3-slot receptacle that will accept the plug on the appliance.
 - b) The marked electrical rating of the cord set or extension cord must equal to or greater than the electrical rating of the appliance. The longer cord should be arranged so that it will not drape over the counter top or table top where it can be pulled on by children or tripped over unintentionally.

NOTE: Neither BLACK+DECKER nor the dealer can accept any liability for damage to the product or personal injury resulting from failure to observe the electrical connection procedures.

SET UP & USE

PARTS & FEATURES

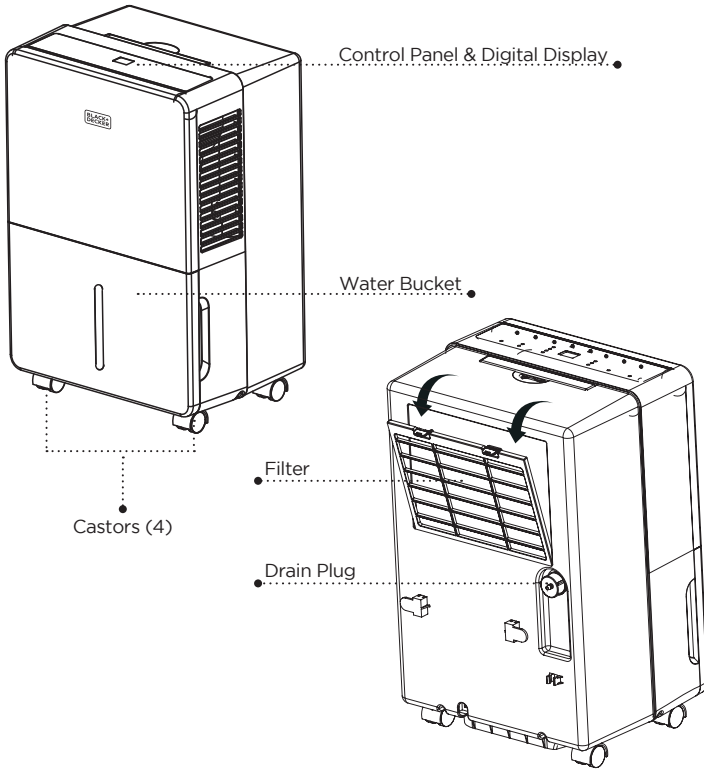

Continuous Drain Kit

Black, Threaded Hose

Drain Adapter & Gasket

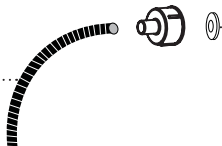

SET UP & USE

CONTROL PANEL

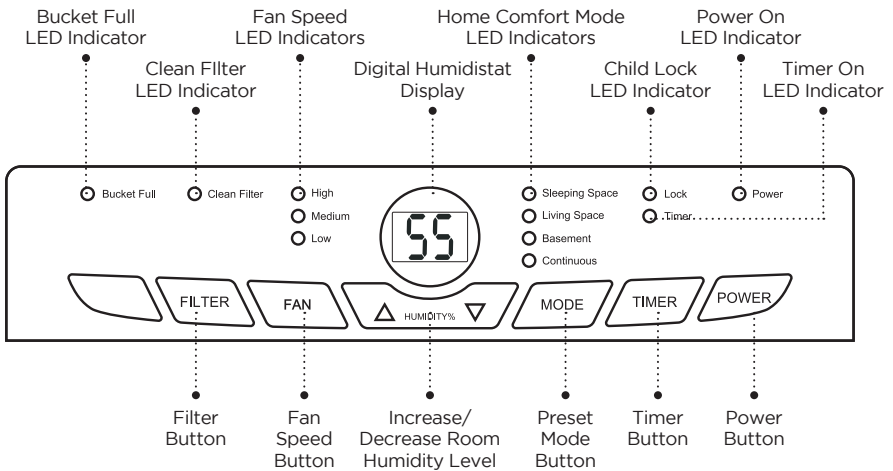

ERROR CODES: (Will appear in the digital humidistat display)

E1: The temperature sensor on the discharge pipe may be faulty and may need to be changed.

E2: The temperature sensor on the heat exchanger may be faulty and may need to be changed.

If any of these error codes appear and remain in the display, please contact the customer service department as listed on page 18 of the user manual

SET UP & USE

INSTALLATION GUIDE

When you open the box, you should have received:

Portable dehumidifier

User Guide

Castors (4)

Continuous Drain Kit

To Install Castors:

1. Remove castors from the water collection bucket.

For the 70 pint model (BDT70), the four castors can be taken out from the side of the bucket directly (see fig 1).

For the 30 pint (BDT30) and 45 pint (BDT45) models, check if the castors are under the lid of the bucket. If so, remove lid to access castors, then replace lid before operation. (see fig. 2)

2. Tilt the dehumidifier no more than 45 degrees and push to insert the castors into the base of the unit. Make sure the ring around the castor is flush against the bottom of the dehumidifier. (see fig. 3).

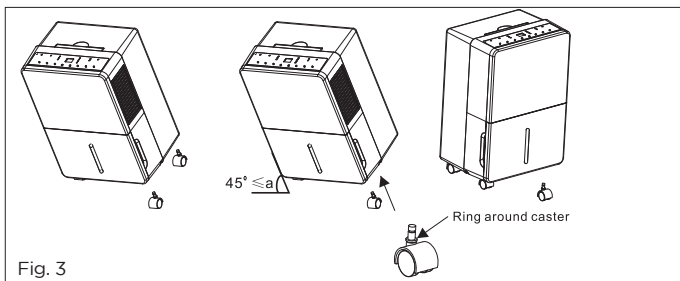
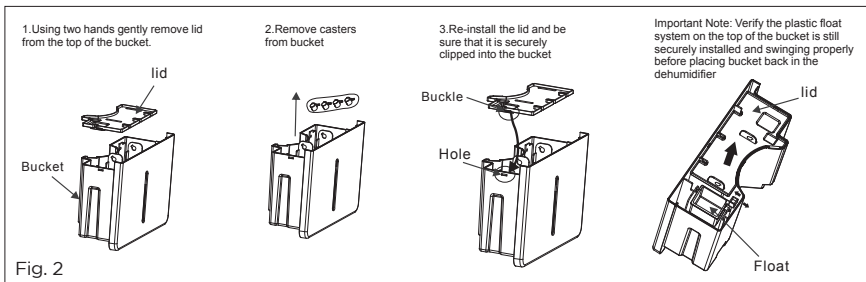
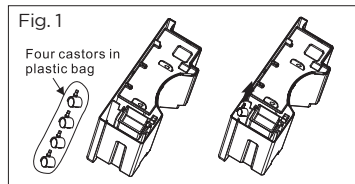

SET UP & USE

BEFORE FIRST OPERATION

1. Grip each side of the bucket and pull to remove the bucket from the dehumidifier (Fig. 4).

Fig. 4

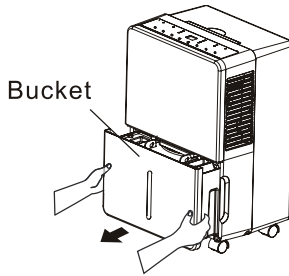

2. Check inside the bucket to make sure the float system is in the correct position. If not, place the float in the correct position (Fig. 5).

Fig. 5

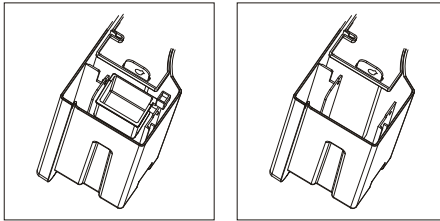

CORRECT

INCORRECT

3. Re-insert the bucket once you have determined the float system is in the correct position (Fig. 6)

Fig. 6

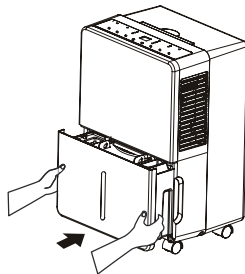

The float in the bucket is essential to the “bucket full” system working properly. Do not remove the float and make sure the float can rotate freely.

SET UP & USE

OPERATION INSTRUCTIONS

1. When first operating the dehumidifier, press MODE button, select “continuous” and allow to run for 24 hours.

NOTE: Unit may shut off automatically during 24 hour period if collection bucket is full (see below). If continuous drainage mode is utilized, and drain hose is connected, the unit will operate continuously (see page 12).

2. Press the POWER button once to turn the unit on. Press POWER button again when you're ready to turn it off.
3. Press the Δ or ∇ buttons just under the display to select the desired relative humidity in the room. Each press will change the room humidity by 5%. The room humidity is selectable from 35-80% or continuous. The unit will cycle on and off to maintain the humidity level chosen on the digital display. If you want the dehumidifier to operate continuously regardless of the room humidity, press MODE button until you see “CO” on the display. This will enable continuous operation and “CONTINUOUS” indicator will light up on the control panel.
4. Press the FAN SPEED button to select between High, Medium and Low. The selected speed will be confirmed by the indicator on the control panel.

TIMER FUNCTION

To program the unit to automatically turn ON, press the TIMER button when the unit is OFF. Press Δ or ∇ to increase the timer in 30 minute increments up to 10 hours. After 10 hours, each press of the Δ will increase the timer in 1 hour increments up to 24 hours. Once the desired time is reached, the unit will automatically turn ON.

To program the unit to automatically turn OFF, press the TIMER button when the unit is ON. Each press of the Δ or ∇ buttons will change the timer setting in 30 minute increments up to 10 hours. After 10 hours, each press of the Δ or ∇ buttons will increase or decrease the timer in 1 hour increments up to 24 hours. Once the desired time is over, the unit will automatically power OFF.

FULL WATER COLLECTION BUCKET

When the water collection bucket is full, the unit will shut off automatically, make a beeping noise and the BUCKET FULL indicator will light. The dehumidifier will not run again until the bucket is emptied and properly placed back inside the unit.

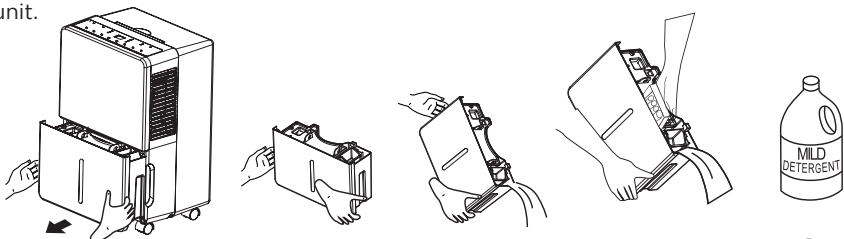

SET UP & USE

NOTE: When the bucket is full or removed from the unit, the compressor will turn off but the fan will continue to run for a few minutes. This is completely normal. The dehumidifier will not be removing moisture from the air at this time.

Over time, the dehumidifier will create a more stable humidity in the area it is located.

The more moisture the dehumidifier removes from the air, the more often you may have to empty the bucket unless you choose to use the continuous drain option. The number of times the bucket will need to be emptied daily will depend on the dehumidifier model.

BDT30	30 pints of moisture removed every 24 hours	empty maximum of 4 times per day
BDT45	45 pints of moisture removed every 24 hours	empty maximum of 6 times per day
BDT70	70 pints of moisture removed every 24 hours	empty maximum of 5 times per day

CAUTION: Do not place the water collection bucket on the floor when it is full as it is uneven on the bottom and may spill.

FILTER CLEANING

When the filter needs to be cleaned, the filter indicator light will come on (after approximately 250 hours of use). Remove the filter from the back of the unit by using your thumbs to press down on the filter tabs directly above the filter.

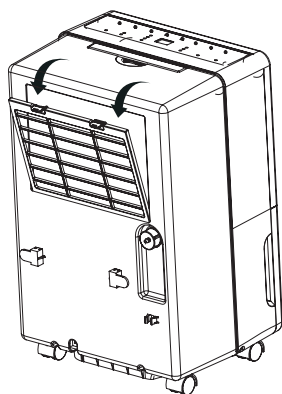

Clean the filter with warm, soapy water and dry thoroughly before putting back in place. Once filter is back in the unit, press the FILTER button to reset the filter indicator.

CAUTION: Do not clean the filter in a dishwasher. Do not operate the humidifier without the included filter in place.

SET UP & USE

PRESET HUMIDITY LEVELS

Preset humidity levels (see PRESET MODE buttons on control panel) allow for dehumidifier to operate at optimum performance depending on whether it is placed in a sleeping space (bedroom), living space (living room, rec room, kitchen) or in a basement.

CHILD LOCK MODE

The child lock mode (see TIMER button on control panel) allows you to lock the control panel, preventing someone from changing the settings. Press and hold The TIMER button for 3 seconds and when locked, the LOCK indicator will light. Press and hold the TIMER button for 3 seconds to unlock the control panel.

AUTOMATIC DEFROST

When frost builds up on the evaporator coils, the compressor will cycle off and the fan will continue to run until the frost disappears. When the coils are completely defrosted, the compressor or fan (depending on model) will automatically restart and dehumidification will resume.

SET UP & USE

CONTINUOUS DRAINAGE

Water can be automatically emptied by attaching the black, threaded hose (included) or a standard garden hose (not included) to the drain port on the back of the dehumidifier. This will allow the unit to run continuously (depending on the selected humidity level) without having to empty the unit's water collection bucket.

To use with black, threaded hose (included)

1. Place dehumidifier on a level surface.
2. Unscrew and remove drain cap to access the garden hose nozzle threads. (See fig. 7)
3. Insert the included gasket into the front of the included drain adapter (see fig. 8).
4. Force the included black, threaded hose on to the drain adapter (see fig. 9).
5. Turn drain adapter clockwise on to the nozzle thread on the back of the unit (see fig. 9).
6. Once securely installed, lead the drain hose to a nearby drain lower than the height of the drain plug. (Make sure there are no kinks or knots in the hose)
7. Turn on the unit and press MODE button until CONTINUOUS indicator is lit.

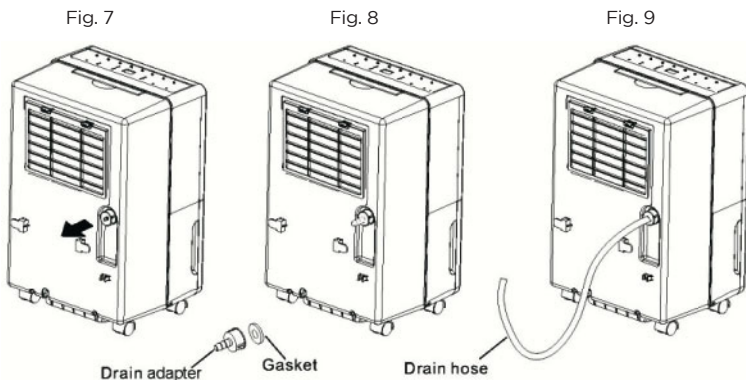

SET UP & USE

To use with standard garden hose (not included)

1. Place dehumidifier on a level surface.
2. Unscrew and remove drain cap to access the garden hose nozzle threads.
3. Screw on garden hose to the now accessible nozzle threads.
4. Once securely installed, lead the drain hose to a nearby drain lower than the height of the drain plug. (Make sure there are no kinks or knots in the hose)
5. Turn on the unit and press MODE button until CONTINUOUS indicator is lit.

NOTE: The thread standard for garden hoses in the U.S. is known as GHT with an outer diameter of 11/16 inches and a pitch of 11.5 TPI.

CAUTION: Placing the dehumidifier on an uneven surface or improper hose installation may result in water filling up the bucket and causing the unit to shut off. Empty the bucket if the auto shutoff occurs, check dehumidifier location for stability and check hose for proper installation. The collection bucket must be properly placed in the dehumidifier for it to operate.

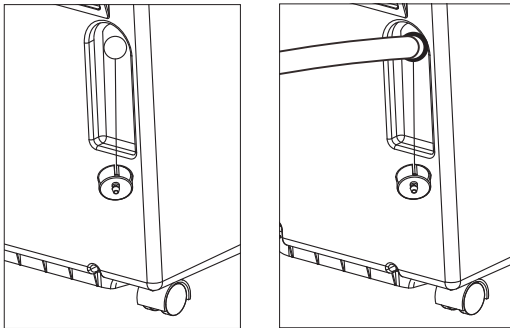

SET UP & USE

GENERAL INFORMATION

Recommended humidity levels:
30%-50% (Too dry, less than 15%, too humid, greater than 50%)

During operation, it is normal for the exhaust coming from the side of the dehumidifier to be warm.

Caused by preliminary factory testing, there may also be a small amount of water present in the bucket before using the dehumidifier for the first time, which is normal.

SPECIFICATIONS

BDT30

Dehumidifying capacity: 30 pints per day
Bucket capacity: 8.5 pints
Air flow volume (high/med/low): 215/180/155 CFM
Power: 115v, 60 Hz, 3.2A
Power consumption: 370 watts

BDT45

Dehumidifying capacity: 45 pints per day
Bucket capacity: 8.5 pints
Air flow volume (high/med/low): 215/180/155 CFM
Power: 115v, 60 Hz, 4.5 A
Power consumption: 450 watts

BDT70

Dehumidifying capacity: 70 pints per day
Bucket capacity: 16.9 pints
Air flow volume (high/med/low): 320/290/250 CFM
Power: 115v, 60 Hz, 6.5A
Power consumption: 730 watts

CARE & CLEANING

CARE AND CLEANING GUIDE

NOTE: Make sure power is off and power cord is not plugged into electrical outlet prior to performing and cleaning to the unit

The water collection bucket should be cleaned every few weeks to prevent the growth of mold, mildew and bacteria. Use a mild detergent to clean the bucket. Once clean, completely dry the bucket and place it back inside the humidifier.

To keep the unit housing clean, keep the unit from being exposed directly to the sun or to prevent color fading. Clean the surface with a damp cloth and dry with a soft towel.

STORING FOR EXTENDED PERIOD OR TRANSPORTING THE UNIT

1. Unplug the unit.
2. Clean or replace filter.
3. Empty any excess water from water collection bucket.
4. Store in dry place.

TROUBLESHOOTING & WARRANTY

BEFORE YOU CALL FOR SERVICE

IF THE DEHUMIDIFIER FAILS TO OPERATE:

- A) Check to make sure that the dehumidifier is plugged in securely. If it is not, remove the plug from the outlet, wait 10 seconds and plug it in again securely.
- B) Check for a blown circuit fuse or a tripped main circuit breaker. If these seem to be operating properly, test the outlet with another appliance.

IF NONE OF THE ABOVE SOLVES THE PROBLEM, CONTACT A QUALIFIED TECHNICIAN. DO NOT TRY TO ADJUST OR REPAIR THE DEHUMIDIFIER YOURSELF.

CUSTOMER SERVICE

IMPORTANT

DO NOT RETURN THIS PRODUCT TO THE STORE

If you have a problem with this product, please contact the W Appliance Co. Customer Satisfaction Center at 844-299-0879.

**DATED PROOF OF PURCHASE, MODEL # AND SERIAL #
REQUIRED FOR WARRANTY SERVICE**

TROUBLESHOOTING & WARRANTY

Troubleshoot your problem by using the chart below. If the dehumidifier still does not work properly, contact W Appliance Co. customer service center or the nearest authorized service center. Customers must never troubleshoot internal components.

TROUBLE	POSSIBLE CAUSE	POSSIBLE REMEDY
Dehumidifier does not start	The dehumidifier is unplugged	Make sure the dehumidifier's plug is pushed completely into the outlet
	The fuse is blown/circuit breaker is tripped	Check the house fuse/circuit breaker box and replace fuse or reset breaker
	Dehumidifier has reached its present level or the bucket is full	The dehumidifier automatically turns off when either condition occurs. Change to a lower setting or empty the water bucket and replace properly
	Bucket is not in the proper position	The bucket must be in place and securely seated for the dehumidifier to operate
	Power failure	There is a protective time delay (up to 3 min.) to prevent tripping of the compressor overload. For this reason, the unit may not start normal dehumidification for 3 minutes after it is powered back on
Dehumidifier does not dry the air as it should	Not enough time allowed for unit to remove moisture	When first installed, allow at least 24 hours to maintain the desired dryness
	Airflow is restricted	Make sure there are no curtains, blinds, or furniture blocking the front or back of the dehumidifier.
	Dirty filter	See the FILTER CLEANING section on page 10
	The humidity control may not be set low enough	For drier air, press the ▽ button to lower the percent humidity desired in the room or set the dehumidifier to CO for maximum dehumidification
	Doors and windows may not be closed tightly	Check that all doors, windows and other openings are securely closed
	Clothes dryer may be blowing moist air into the room	Install the dehumidifier away from the dryer. The dryer should be vented outside.
	Room temperature is too low	Moisture removal is best at higher room temperatures. Lower room temperatures will reduce the moisture removal rate. This model is designed to operate at temperatures above 41°F
Dehumidifier runs too much	The area is too large for the capability of the dehumidifier	The capacity of your dehumidifier may not be adequate for the room size
	Doors and windows are open	Close all doors and windows to the outside
Frost appears on the coils	The dehumidifier has recently been turned on or the room temperature is below 41° F	This is normal. Frost will usually disappear within 60 minutes
Controls cannot be set	The compressor will turn off and the fan will automatically continue to run for approximately 3 minutes at a fixed setting	This is normal. Wait approximately 3 minutes and set the fan speed at the desired level
Fan noise	Air is moving through the unit	This is normal
Water on the floor	Hose connection may be loose	Check the hose connection. See the CONTINUOUS DRAINAGE SECTION on page 12
	Hose is attached but not draining into a drain	Disconnect the hose if using the bucket or place the hose near a drain

TROUBLESHOOTING & WARRANTY

LIMITED WARRANTY

Any repair, replacement, or warranty service, and all questions about this product should be directed to W Appliance Co. at **844-299-0879** from the USA or Puerto Rico.

W Appliance Co. warrants to the original purchaser that the product will be free from defects in material, parts and workmanship for the period designated for this product. The warranty commences the day the product is purchased and covers up to a period of **1 year (12 months) for labor/1 year (12 months) for parts (manufacturing defects only)/and a total of 5 years (60 months) for compressor part only.**

W Appliance Co. agrees that it will, at its option, replace the defective product with either a new or remanufactured unit equivalent to your original purchase during the warranty period.

Exclusions: This warranty does not apply to the below:

1. If the appearance or exterior of the product has been damaged or defaced, altered or modified in design or construction.
2. If the product original serial number has been altered or removed or cannot be readily determined.
3. If there is damaged due to power line surge, user damage to the AC power cord or connection to improper voltage source.
4. If damage is due to general misuse, accidents or acts of God.
5. If repair attempts are done by unauthorized service agents, use of parts other than genuine parts or parts obtained from persons other than authorized service companies.
6. On units that have been transferred from the original owner.
7. On products that have been purchased as refurbished, like new, second-hand, in a "As-Is" or "Final Sale" terms.
8. To products used in a commercial or rental setting.
9. To products used in settings other than ordinary household use or used other than in accordance with the provided instructions.
10. To damages for service calls for improper installations.
11. To glass parts and other accessory items that are included with the unit.
12. Transportation and shipping costs associated with the replacement of the unit.

13. Food loss for loss due to product failure or delay in service, repair or replacement.
14. Service calls to instruct you how to use your product.
15. Service calls to repair or replace the house fuse, reset the circuit breaker or correct the wiring in the house.

REPAIR OR REPLACEMENT AS PROVIDED UNDER THIS WARRANTY IS THE EXCLUSIVE REMEDY OF THE CUSTOMER; W Appliance Co. SHALL NOT BE LIABLE FOR ANY INCIDENTAL OR CONSEQUENTIAL DAMAGES FOR BREACH OF ANY EXPRESS OR IMPLIED WARRANTY ON THIS PRODUCT, EXCEPT TO THE EXTENT PROHIBITED BY APPLICABLE LAW. ANY IMPLIED WARRANTY OF MERCHANTABILITY OF FITNESS FOR A PARTICULAR PURPOSE ON THIS PRODUCT IS LIMITED TO THE DURATION OF THE WARRANTY.

Some states do not allow the exclusion or limitations of incidental or consequential damages, or limitations on how long the warranty lasts. In these cases the above exclusions or limitations may not apply to you. This warranty gives you specific legal rights and you may also have other rights which vary from state to state.

Obtaining Service: To obtain service, product literature, supplies or accessories please call **844-299-0879** to create a ticket for exchange/repair. Please make sure to provide the date of purchase, model number and a brief description of the problem. Our customer service representative will contact you or send detailed return instructions.

W Appliance Co. does not warrant that the appliance will work properly in all environmental conditions, and makes no warranty and representation, either implied or expressed, with respect to the quality, performance, merchantability, or fitness for a particular purpose other than the purpose identified within this user's manual. W Appliance Co. has made every effort to ensure that this user's manual is accurate and disclaims liability for any inaccuracies or omissions that may have occurred. Information in this user's manual is subject to change without notice and does not represent a commitment on the part of W Appliance Co.. W Appliance Co. reserves the right to make improvements to this user's manual and/or to the products described in this user's manual at any time without notice. If you find information in this manual that is incorrect, misleading, or incomplete, please contact us at **844-299-0879**.

W Appliance Co.
New York, NY 10018

BLACK & DECKER, BLACK+DECKER, the BLACK & DECKER and BLACK+DECKER logos and product names and the orange and black color scheme are trademarks of The Black & Decker Corporation, used under license. All rights reserved.

Product in this box may differ slightly from that pictured. Does not affect function. Not all accessories shown in photography are included in this package.

Imported by W Appliance, Inc., 1356 Broadway, New York, NY 10018