



Self-Cleaning Oven with Trivection™

# Built-In Oven

*Safety Instructions* .....2-7

*Operating Instructions*

Adjusting Temperature .....34

Clock, Timer and Control Lockout .....12

Controls .....9-11

Convection .....24-27

Defrost Feature, Guide .....19, 20

Introduction .....8

Oven .....13-15

Proof, Warmer and Warm .....29

Recipes .....28

Sabbath Feature .....35-37

Self-Cleaning Oven .....30, 31

Settings .....32, 33

Speed Baking/Speed Roasting .....16, 17

Speed Broiling, Guide .....17, 18

Timed Baking and Roasting .....22, 26, 27

Traditional Baking/Roasting ..21, 22

Traditional Broiling, Guide .....23

*Care and Cleaning*

Cleaning Oven Door .....38

Control Panel .....39

Light Bulb .....37

Packaging Tape .....37

Racks .....39

Stainless Steel Surfaces .....38

*Troubleshooting Tips* .....40-43

*Accessories* .....44

*Consumer Support*

Consumer Support .....Back Cover

Product Registration .....45, 46

Warranty .....47

**Write the model and serial numbers here:**

**Model #** \_\_\_\_\_

**Serial #** \_\_\_\_\_

You can find them on a label on the side trim or on the front of the (lower) oven behind the oven door.

## Owner's Manual

*JT930—30" Single Wall Oven*  
*JT980—30" Double Wall Oven*



## IMPORTANT SAFETY INFORMATION. READ ALL INSTRUCTIONS BEFORE USING.

### **WARNING!**

For your safety, the information in this manual must be followed to minimize the risk of fire or explosion, electric shock, or to prevent property damage, personal injury, or loss of life.

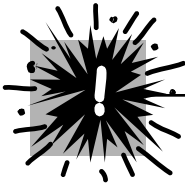

### PRECAUTIONS TO AVOID POSSIBLE EXPOSURE TO EXCESSIVE MICROWAVE ENERGY

- Do not attempt to operate this oven with the door open since open-door operation can result in harmful exposure to microwave energy. **It is important not to defeat or tamper with the safety interlocks.**
- Do not place any object between the oven front face and the door or allow soil or cleaner residue to accumulate on sealing surfaces.
- The oven should not be adjusted or repaired by anyone except properly qualified service personnel.
- Do not operate the oven if it is damaged. It is particularly important that the oven door close properly and that there is no damage to the:
  - 1 door (bent),
  - 2 hinges and latches (broken or loosened),
  - 3 door seals and sealing surfaces.



### IMPORTANT SAFETY NOTICE

*The California Safe Drinking Water and Toxic Enforcement Act requires the Governor of California to publish a list of substances known to the state to cause cancer, birth defects or other reproductive harm, and requires businesses to warn customers of potential exposure to such substances.*

*The fiberglass insulation in self-clean ovens gives off a very small amount of carbon monoxide during the cleaning cycle. Exposure can be minimized by venting with an open window or using a ventilation fan or hood.*



## SAFETY PRECAUTIONS

When using electrical appliances, basic safety precautions should be followed, including the following:

### **WARNING**—Grounding Instructions:

This appliance must be connected to a grounded, metallic, permanent wiring system, or an equipment grounding conductor should be run with the circuit conductors and connected to the equipment grounding terminal or lead on the appliance.

### **WARNING**—To reduce the risk of burns, electric shock, fire, injury to persons or exposure to excessive microwave energy:

- Use this appliance only for its intended purpose as described in this manual. Do not use corrosive chemicals or vapors in this appliance. This oven is specifically designed to heat or cook food, and is not intended for laboratory or industrial use.
- Be sure your appliance is properly installed and grounded by a qualified technician in accordance with the provided installation instructions.
- Do not attempt to repair or replace any part of your oven unless it is specifically recommended in this manual. All other servicing should be referred to a qualified technician.
- Have the installer show you the location of the circuit breaker or fuse. Mark it for easy reference.
- Before performing any service, disconnect the oven power supply at the household distribution panel by removing the fuse or switching off the circuit breaker.
- Do not leave children alone—children should not be left alone or unattended in an area where an appliance is in use. They should never be allowed to sit or stand on any part of the appliance.
- Do not store this appliance outdoors. Do not use this product near water—for example, in a wet basement, or near a swimming pool.
- Do not operate this appliance if it has a damaged cord or plug, if it is not working properly or if it has been damaged or dropped.
- This appliance should be serviced only by qualified service personnel. Contact nearest authorized service facility for examination, repair or adjustment.
- Do not allow anyone to climb, stand or hang on the door. They could damage the oven, or cause severe personal injury.
- Be sure the oven is securely installed in a cabinet that is firmly attached to the house structure. Never allow anyone to climb, sit, stand or hang on the oven door.
- Never leave the oven door open when you are not watching the oven.
- Always keep combustible wall coverings, curtains or drapes a safe distance from your oven.
- Always keep dish towels, dish cloths, pot holders and other linens a safe distance from your oven.
- Always keep wooden and plastic utensils and canned food a safe distance away from your oven.
- Teach children not to play with the controls or any other part of the oven.
- Large scratches or impacts to glass doors can lead to broken or shattered glass.
- Do not cover or block any openings on the appliance.

## IMPORTANT SAFETY INFORMATION. READ ALL INSTRUCTIONS BEFORE USING.



### **⚠ WARNING!** SAFETY PRECAUTIONS

- Do not store flammable materials in an oven.

- **CAUTION:** Items of interest to children should not be stored in cabinets above an oven; children climbing on the oven to reach items could be seriously injured.
- Never wear loose-fitting or hanging garments while using the appliance. Be careful when reaching for items stored in cabinets over the oven. Flammable material could be ignited if brought in contact with hot surfaces or heating elements and may cause severe burns.

- Use only dry pot holders—moist or damp pot holders on hot surfaces may result in burns from steam. Do not let pot holders touch hot heating elements. Do not use a towel or other bulky cloth.
- For your safety, never use your appliance for warming or heating the room.
- Do not let cooking grease or other flammable materials accumulate in or near the oven.
- Do not use water on grease fires. Never pick up a flaming pan. Turn the controls off.

Flame in the oven can be smothered completely by closing the oven door and turning the oven off or by using a multi-purpose dry chemical or foam-type fire extinguisher.

- Do not touch the heating elements or the interior surface of the oven. These surfaces may be hot enough to burn even though they are dark in color. During and after use, do not touch, or let clothing or other flammable materials contact any interior area of the oven; allow sufficient time for cooling first.

Potentially hot surfaces include oven vent openings, surfaces near the openings, crevices around the oven door, the edges of the window and metal trim parts above the door.

**REMEMBER:** The inside surface of the oven may be hot when the door is opened.

- Never leave jars or cans of fat drippings in or near your oven.
- Do not store or use combustible materials, gasoline or other flammable vapors and liquids in the vicinity of this or any other appliance.
- Stand away from the oven when opening the oven door. Hot air or steam which escapes can cause burns to hands, face and/or eyes.
- Do not heat unopened food containers. Pressure could build up and the container could burst, causing an injury.
- Keep the oven vent unobstructed.
- Keep the oven free from grease buildup.
- Place the oven rack in the desired position while the oven is cool. If racks must be handled when hot, do not let pot holder contact the heating elements.
- When using cooking or roasting bags in the oven, follow the manufacturer's directions.
- Pulling out the rack to the stop-lock is a convenience in lifting heavy foods. It is also a precaution against burns from touching hot surfaces of the door or oven walls.
- Do not use the oven to dry newspapers. If overheated, they can catch on fire.
- Do not use the oven for a storage area. Items stored in an oven can ignite.
- Do not leave paper products, cooking utensils or food in the oven when not in use.
- After broiling, always take any broiler pan out of the oven and clean it. Leftover grease in a broiler pan can catch fire next time you use the pan.
- Clean only parts listed in this Owner's Manual.
- Do not use aluminum foil to line oven bottoms. Improper installation of aluminum foil may result in a risk of electric shock or fire.



## TRIVECTION™ OVEN

Read and follow the specific “Precautions to Avoid Possible Exposure to Excessive Microwave Energy” section in this manual.

### To reduce the risk of fire in the oven cavity:

- Do not overcook food. Carefully attend appliance if paper, plastic or other combustible materials are placed inside the oven to facilitate cooking.
- In defrost mode, remove wire twist-ties from paper or plastic containers before placing bags in the oven.
- Oven Cooking Bags—Do not use the wire twist-tie to close the bag.
- Do not use paper towels.
- Do not use your oven to dry newspapers.
- Do not overcook potatoes. They could dehydrate and catch fire, causing damage to your oven.
- Do not operate the oven while empty to avoid damage to the oven and the danger of fire.
- Do not use the oven for storage purposes. Do not leave paper products, cooking utensils or food in the oven when not in use.
- If materials inside the oven should ignite, keep the oven door closed, turn the oven off and shut off power at the fuse or circuit breaker panel. If the door is opened, the fire may spread.
- This oven is not approved or tested for marine use.
- Some products such as whole eggs and sealed containers—for example, closed jars—will explode and should not be heated in this oven. Such use of the oven could result in injury.
- Do not boil eggs in this oven. Pressure will build up inside the egg yolk and will cause it to burst, possibly resulting in injury.
- Do not pop popcorn in your oven.
- Foods with unbroken outer “skin” such as potatoes, sausages, tomatoes, apples, egg yolks, chicken livers and other giblets should be pierced to allow steam to escape during cooking.
- Don’t defrost frozen beverages in narrow-necked bottles (especially carbonated beverages). Even if the container is opened, pressure can build up. This can cause the container to burst, possibly resulting in injury.
- Hot foods and steam can cause burns. Be careful when opening any containers of hot food, cooking pouches and boxes. To prevent possible injury, direct steam away from hands and face.
- As with any appliance, close supervision is necessary when used by children.

## IMPORTANT SAFETY INFORMATION. READ ALL INSTRUCTIONS BEFORE USING.



### ALL THESE THINGS ARE NORMAL WITH YOUR TRIVECTION™ OVEN

- Steam or vapor escaping from around the door.
- Dimming of the oven light and change in the blower sound may occur.
- The microwave fan may operate with both ovens off. It is cooling the control and will turn itself off.
- Some TV-radio interference might be noticed while using your oven. It is similar to the interference caused by other small appliances and does not indicate a problem with your oven.



### ARCING

If you see arcing, open the door and correct the problem.

**Arcing is the microwave term for sparks in the oven. Arcing is caused by:**

- Metal or foil touching the side of the oven.
- Metal, such as twist-ties, poultry pins or gold-rimmed dishes in the oven.
- Foil not molded to food (upturned edges act like antennas).
- Recycled paper towels containing small metal pieces being used in the oven.



### SUPER HEATED WATER AND SPONTANEOUS BOILING

Liquids such as water, coffee or tea are able to be overheated beyond the boiling point without appearing to be boiling. Visible bubbling or boiling when the container is removed from the microwave oven is not always present. **THIS COULD RESULT IN VERY HOT LIQUIDS SUDDENLY BOILING OVER WHEN THE CONTAINER IS DISTURBED OR A UTENSIL IS INSERTED INTO THE LIQUID.**



## COOK MEAT AND POULTRY THOROUGHLY...

Cook meat and poultry thoroughly—meat to at least an INTERNAL temperature of 160°F and poultry to at least an INTERNAL temperature of 180°F. Cooking to these temperatures usually protects against foodborne illness.

## SELF-CLEANING OVEN

- Do not clean the door gasket. The door gasket is essential for a good seal. Care should be taken not to rub, damage or move the gasket.
- Do not use oven cleaners. No commercial oven cleaner or oven liner protective coating of any kind should be used in or around any part of the oven. Residue from oven cleaners will damage the inside of the oven when the self-clean cycle is used.
- Keep the oven vent unobstructed.
- Before self-cleaning the oven, remove shiny, silver-colored oven racks (on some models) and all other cookware.
- Be sure to wipe up excess spillage before starting the self-cleaning operation.
- If the self-cleaning mode malfunctions, turn the oven off and disconnect the power supply. Have it serviced by a qualified technician.
- Listen for fan—A fan noise should be heard sometime during the cleaning cycle. If not, call a serviceman before self-cleaning again.



READ AND FOLLOW THIS SAFETY INFORMATION CAREFULLY.

**SAVE THESE INSTRUCTIONS**

## Introduction.

The GE Profile oven with Trivection™ technology is a microwave-assist wall oven designed to cook food up to five times faster than a traditional oven. This oven gives the user the flexibility to cook food in traditional cooking modes (bake or broil), convection modes (convection bake and convection roast) or in speedcook modes (speed bake and speed broil). This oven features easy-to-use controls that will guide you through oven operations.

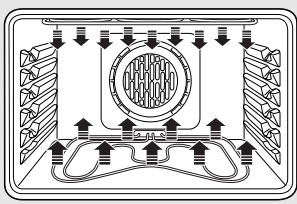

### Bake

Baking is cooking with heated air. The upper and lower elements cycle back and forth to heat the air and maintain temperature. Used for traditional baking and roasting. Best for delicate items.

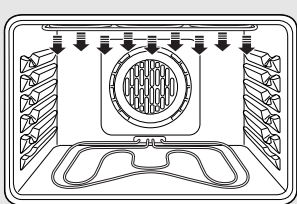

### Broil

Heat is provided by the upper element to broil your food. May be used with the oven door open or closed.

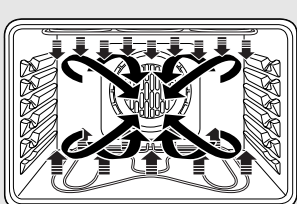

### Convection Bake—Multi and Single Rack

Heat is provided by the element in the back of the oven, along with the upper and lower elements. The air is circulated with a reversing fan system. The fan will change directions to provide optimal

evenness and browning. The **Multi Rack** option is ideal for evenly baking foods when using more than one rack. The **1 Rack** option, used for one rack of food, cooks food faster than **BAKE** mode.

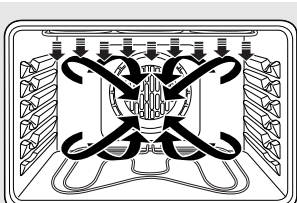

### Convection Roast

Heat is provided by the upper element and circulated with the reversing fan system. The fan will change directions to provide optimal evenness and browning. Good for roasting large tender cuts of

meat or poultry, uncovered. Roasts foods up to 25% faster.

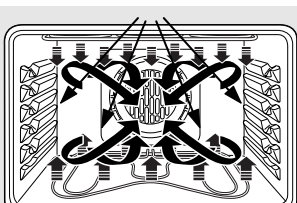

### Speed Bake

Heat is provided by the three elements and microwave. The exact combination of elements is automatically determined by the food category selected. Air is

circulated with the reversing fan system described above. **Ideal for baking and roasting foods up to five times faster.**

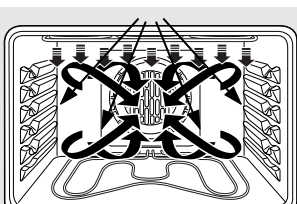

### Speed Broil

Heat is provided by the upper element and microwave. Air is circulated with the reversing fan system described above. Oven door must be closed. **Ideal for broiling foods to medium to well done**

**doneess levels two times faster than traditional broil.**



# Using the oven controls.

(Throughout this manual, features and appearance may vary from your model.)

ge.com

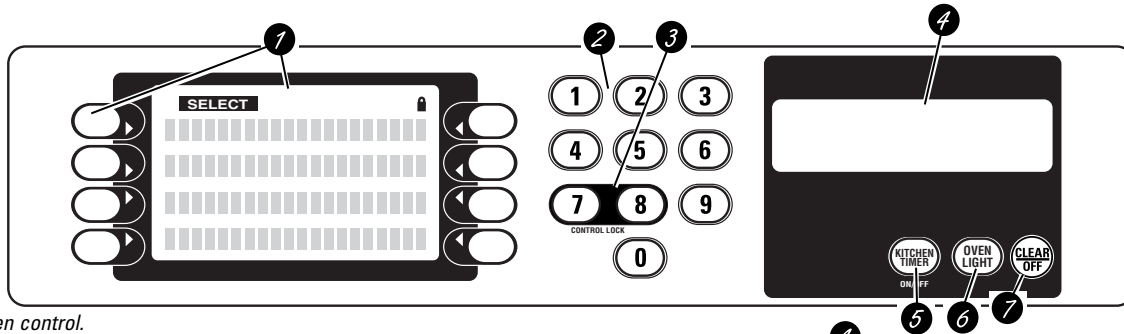

Single oven control.

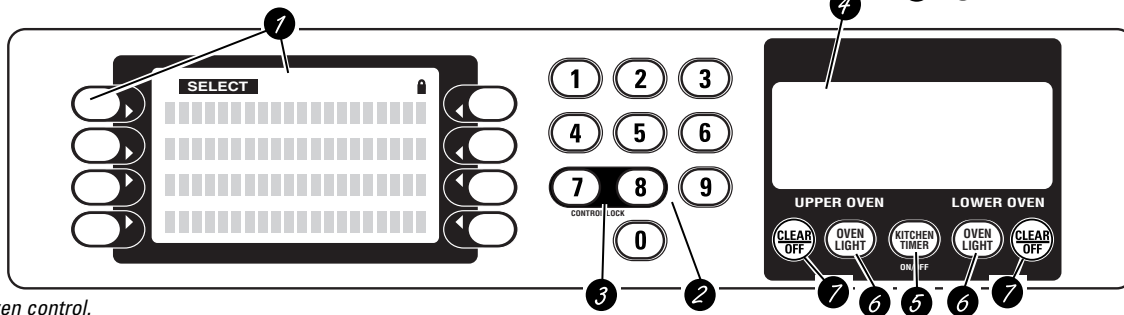

Double oven control.



## Oven Control Layout and Description

- 1 Control Screen & Keypad**  
All cooking modes, special features and oven settings are directed and operated from the control screen. Directions for operating the oven and prompting for required information are displayed within the control screen.
- 2 Numeric Keypad**  
Used to enter information requiring numbers such as time of day on the clock, timer, oven temperature, start time and length of operation for timed baking and self-cleaning.
- 3 Control Lockout**  
Allows the user to lock the control so that the touch pads cannot be activated when pressed.
- 4 Time and Temperature Display**  
All time and temperature information is displayed in this area as feedback to the user.
- 5 Kitchen Timer**  
Turns the kitchen timer on and off. Does not control the oven.
- 6 Oven Light**  
Turns oven light on or off.
- 7 Clear/Off**  
Cancels **ALL** oven operations **EXCEPT** the clock and timer.

**If "F- and a number or letter" flash in the display and the oven control signals, this indicates a function error code.** Press the **CLEAR/OFF** pad. Allow the oven to cool for one hour. Put the oven back into operation. If the function error code repeats, disconnect the power to the oven and call for service.

**If your oven was set for a timed oven operation and a power outage occurred, the clock and all programmed functions must be reset.**

**The time of day will flash in the display when there has been a power outage.**

## Using the oven controls.

(Throughout this manual, features and appearance may vary from your model.)

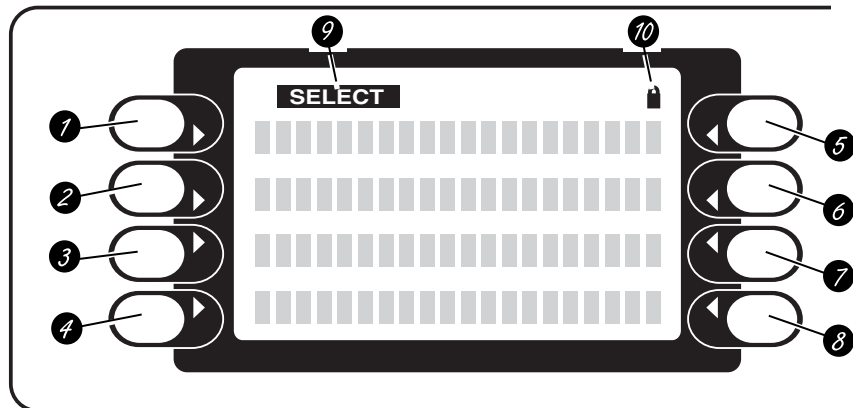

### Control Screen and Keypad

Press pad beside display to select item in display.

**Oven Control Sleep Feature**—Any time the oven is not in use (no cooking, no cleaning, no help and no timers) for more than 10 minutes, the oven control will go to sleep. While sleeping, the control display will not show any text; it will go blank. The clock will remain displayed in the time and temperature display unless the “no clock” option has been selected.

There will be no audible signal given to indicate that the control is entering the sleep feature.

The control will enter the sleep feature even when the control is locked.

The user **cannot** turn this feature **OFF**.

**How to Exit the Sleep Feature**—Touch any key. The function associated with that key will not be started, but the control display main menu will reappear.

**1 Speedcook**  
In **Speedcook** mode, the user will be prompted to enter food category, temperature and cooking time.

**Speed bake**—Bakes food faster than traditional cooking modes.

**Speed broil**—Broils food faster than traditional Hi/Lo Broil.

**2 Bake**  
Traditional bake mode.

**3 Convection**  
**Conv 1-Rack**—Convection bake function used for baking on one rack.  
**Conv Multi**—Convection bake function used for baking on more than one rack.  
**ConvRoast**—Convection roast function.

**4 Broil**  
**LO & HI**—Traditional broil function.

**5 Features**  
Additional cooking-related features.

**Defrost**—This feature is used to thaw frozen foods. Enter the defrost time using the chart in the *Using the Defrost Feature* section.

**Self-Clean**—This feature cleans the oven. See the *Using the self-cleaning oven* section.

**Warmer**—This feature keeps hot, cooked food warm for up to 3 hours. It is not intended for reheating cold food. See the *How to Set the Oven for Warmer* section.

**Proof**—This feature maintains a warm environment useful for rising yeast-leavened products. It is not intended to keep food warm or reheat cold food. See the *How to Set the Oven for Proof* section.

**Warm (Cook & Hold)**—When this feature is turned on, it will keep hot, cooked foods warm for up to 3 hours following a Timed Bake function. See the *How to Set the Oven for Warm* section.

**Sabbath**—Designed for use on the Jewish Sabbath and Holidays. See the *Using the Sabbath Feature* section.



## Control Screen and Keypad

- 6** **Settings**  
This oven has additional settings that you may choose to use. See the **Settings** section.
- 7** **Recipes**  
**NOTE:** On double wall ovens, **Recipes** is available only on the upper oven.  
This oven feature allows the user to store up to six temperature/cooking time combinations. The user can then speed bake, bake or convection bake/roast one of the six stored favorite recipes without having to choose the settings each time.
- 8** **Help**  
Provides basic information on each function and how to find the function. If selected from the home screen, it gives general help. If selected while performing a function, it gives help on that function. Select **Exit** to leave **Help**.
- 9** **Select Prompt**  
Visual prompt to the user indicating that a selection needs to be made from the control screen.
- 10** **Door Lock Indicator**  
Indicates that the oven door is locked for self-clean.

## Using the clock, timer and control lockout.

Make sure the clock is set to the correct time of day.

### To Set the Clock

The clock must be set to the correct time of day for the automatic oven timing functions to work properly. The time of day cannot be changed during timed baking, a self-cleaning cycle or delayed start time.

- 1 Select **SETTINGS**.
- 2 Select **CLOCK**.
- 3 Press the number pads.
- 4 Select **ENTER**.



The timer is an hour and minute timer only.

The timer does not control oven operations. The maximum setting on the timer is 9 hours and 59 minutes.

To set 10 minutes, enter 10. DO NOT enter 10:00!

### To Set the Timer

- 1 Press the **KITCHEN TIMER** pad.
- 2 Press the number pads until the amount of time you want shows in the display. For example, to set 2 hours and 45 minutes, press **2**, **4** and **5** in that order. If you make a mistake, press the **KITCHEN TIMER** pad and begin again.
- 3 Select **START**.  
After selecting **START**, **SET** disappears; this tells you the time is counting down, although the display does not change until

one minute has passed. Seconds will not be shown in the display until the last minute is counting down.

- 4 When the timer reaches **:00**, the control will beep 3 times followed by one beep every 6 seconds until the **KITCHEN TIMER** pad is pressed once.

The continuous beep can be canceled by following the steps in the *Settings* section under *Tones at the End of a Timed Cycle*.

### To Reset the Timer

If the remaining time is not in the display (clock, delay start or cooking time are in the display), recall the remaining time by pressing the **KITCHEN TIMER** pad or using **REVIEW TIMES**.

You may change it by pressing the **KITCHEN TIMER** pad, then press the number pads until the time you want appears in the display.

### To Cancel the Timer

Press **KITCHEN TIMER** pad twice.



### Control Lockout

Your control will allow you to lock out the touch pads so they cannot be activated when pressed.

**NOTE:** On double oven models, this activates this feature for both ovens.

To lock/unlock the controls:

- 1 Press the **7** and **8** pads at the same time for 3 seconds, until the control screen shows **CONTROL IS LOCKED**.

- 2 To unlock the control, press the **7** and **8** pads at the same time for 3 seconds, until **CONTROL IS LOCKED** disappears from the control screen and the main menu is displayed.

When this feature is on and the touch pads are pressed, the control will show **CONTROL IS LOCKED**.

- The control lockout mode affects all touch pads.
- The control will remain locked after a power failure.

# Using the oven.

To avoid possible burns, place the racks in the desired position before you turn the oven on.

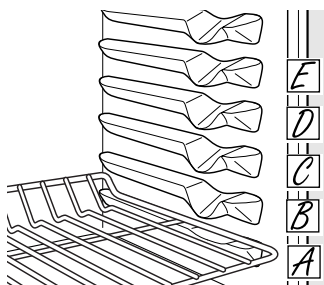

## Before you begin...

The racks have stop-locks, so that when placed correctly on the supports, they will stop before coming completely out, and will not tilt.

When placing and removing cookware, pull the rack out to the bump on the rack support.

**To remove a rack,** pull it toward you, tilt the front end up and pull it out.

**To replace,** place the end of the rack (stop-locks) on the support, tilt up the front and push the rack in.

**NOTE:** On double wall ovens, the rack design is unique for the upper Trivection™ oven. Due to this, the upper oven racks and the lower oven racks are not interchangeable.

**NOTE:** A cooling fan will automatically turn on during all cooking modes. This fan turns on to cool internal parts. It may run for up to 1-1/2 hours after the oven is turned off.

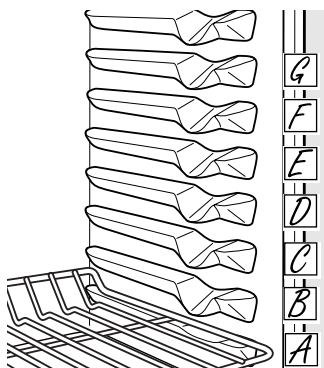

30" Trivection™ oven has 5 rack positions A–E (as shown).

30" lower oven of double oven has 7 rack positions A–G (as shown).

## Using the Trivection™ oven.

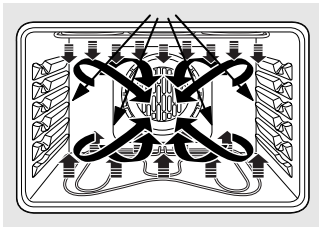

### Microwave Assisted

In the Trivection oven, a microwave is used to assist cooking.

The combination of microwave, convection fan and heating elements is unique for each food category.

**NOTE:** The microwave will cycle on and off while cooking to best distribute energy to the food.

**The microwave turns off and the cook time stops counting down when the oven door is opened.**

**NOTE:** The convection fan may cycle on and off and change direction while cooking to best distribute hot air in the oven. The convection fan shuts off when the oven door is opened.

### Auto Recipe™ Conversion

You can use your favorite recipes in the Trivection oven.

**When speedcooking, enter the traditional cooking temperature and the maximum recipe/package cook time.** When speedcooking, the Auto Recipe™ conversion feature automatically converts traditional cook time into the appropriate

speedcooking time. The converted time will display after you start the oven. This time will be up to 5 times faster than traditional baking based on food type.

### Cookware for Speedcooking . . .

You can use cookware that is oven-safe. Heat-resistant paper and plastic containers and bakeware that are recommended for use in traditional baking can also be used for speed baking. However, they should not be used at temperatures higher than the temperature recommended by the bakeware manufacturer.

If you are cooking with several pans, leave space between them. Arcing is the microwave term for sparks in the oven. To avoid arcing, be sure there is at least 1 inch of space between metal surfaces—pans, wall of cavity, aluminum foil.

Do not completely surround food with metal and/or foil while speedcooking—you will not have a time savings (for example, wrapping potato with foil, using metal roasting pan with lid).

When using a metal pan, do not cover it with a metal lid or foil (a glass lid or parchment paper may be used). However, foil may be used to shield food to prevent overbrowning or overcooking (i.e., placing small strips of foil on tips of wings and legs of poultry). Also, foil covers may be tented over food (i.e., large frozen casseroles) toward the end of their cook time to prevent overbrowning or overcooking.

**DO NOT USE FOOD WRAPPERS MADE FROM A COMBINATION OF METAL FOIL AND PAPER IN THE OVEN** in speedcook modes. For example, some frozen or deli breads are baked and sold in these wrappers. Remove the food from the wrapper and speed bake on a flat metal pan.

When speedcooking with metal pans, heavy aluminum pans are recommended for best results.

When speed baking with stoneware or cooking stones, refer to the manufacturer's owner's manual for proper use and maintenance. For best results, preheat your flat cooking stones. If the manufacturer does not recommend preheating the cooking stones, do not use them in Speedcooking modes. **Do not use hearth inserts while speedcooking.**

Use pans with low sides whenever possible. A shallow pan allows air to circulate around the food more efficiently.

Dark or matte finish bakeware will produce darker browning on food. When you are speed broiling, it is important that you use the broiler pan with grid for best results. The pan is used to catch grease spills and the grid is used to prevent grease spatters.

## Other Speedcooking Tips . . .

### You must preheat your oven.

Put the food in the oven after the preheat beep when the oven control displays “Put Food In Oven” and then press **START**. **You must press the START key after placing the food in the oven to start the speedcook mode.**

When choosing a speedcook food category, refer to the chart on page 16.

### All frozen foods should be speedcooked using the FROZENFOODS category.

When baking potatoes, the recommended cooking temperature is 350°F and cooking time is 90 minutes for medium sized potatoes. Add an additional 15–30 minutes for large potatoes or when baking more than four potatoes.

In general, when cooking meats wrapped in dough or refrigerated dough product, use the Biscuit/Roll or BakedGoods category.

For recipes using a large quantity of cheese, milk and/or eggs, use the BakedGoods category.

Larger amounts of food or multiple racks of food may require additional time. Check food doneness as prompted and continue cooking as needed.

Items such as appetizers, cookies, biscuits and rolls can be speed baked on multiple racks. Cooking time may increase slightly for some foods, but since two or three racks of food are being cooked at the same time, the overall result is substantial time saved.

When cooking multiple items or pans, leave space between them for maximum air circulation.

Cakes and quick breads (banana, zucchini or pumpkin bread) are not recommended for multiple rack speed baking. Place cakes side-by-side on one rack if speed baking. When using more than one rack to cook these foods, use **CONV MULTI** mode. See *Using the convection modes* section.

### Meats/Poultry

Cooking times will vary depending on the cut of meat. Check for doneness at minimum time. **Note:** Meats will continue to cook and internal temperatures will rise after they are removed from the oven (standing time).

Use the broiler pan and grid provided with your oven for best results.

As in a conventional oven, aluminum foil may be used to shield food—to prevent overbrowning or overcooking (i.e., placing small strips of foil on tips of wings and legs of poultry). Also, foil covers may be tented over food (i.e., large frozen casseroles) toward the end of their cook time to prevent overbrowning or overcooking. Make sure that the foil is securely attached to the food. However, large amounts of foil or fully enclosing food in foil blocks the microwave energy, which eliminates time savings.

### Do not use oven thermometers, meat thermometers or wire twist-ties in the oven while speedcooking.

Pop-up thermometers in your meat may be inaccurate. Check the temperature of the meat with a thermometer after removing the meat from the oven.

For best results, speed bake turkeys unstuffed.

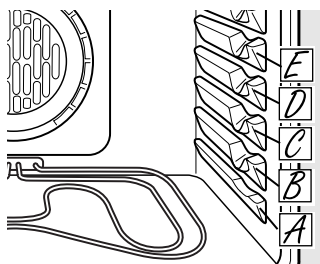

Rack positions, Trivection™ Oven.

## Rack Positions for Speed Baking . . .

If cooking on one rack, place food so that it is approximately centered in the oven.

### Rack Positions and Examples

- C** Cookies, pizza, pie, muffins, cakes, biscuits, casseroles
- B** Loaves of bread, bundt cakes, meat loaf, small and medium roasts, whole chicken
- A** Very tall items: turkey, large roasts, angel food cakes

If cooking on two racks, use rack positions A and D to provide lots of space between items for optimal results.

If cooking on three racks, use rack positions A, C and E.

## Using the Trivection™ oven.

### How to Set the Oven for Speed Baking

- 1 Select **SPEEDCOOK** from the main menu.
- 2 Select **SPEED BAKE** when baking or roasting.
- 3 Select food type. You can select **FROZENFOODS, MEAT** or **VEG/CASS**. Select **MORE** to see additional categories—**POULTRY/FISH, BAKEDGOODS** and **BREADS**. Reference the table for food category and time savings.  
**NOTE:** You will need to select a subcategory for some food types. For example, if you select **VEG/CASS**, you will need to select between **BAKED POTATO, VEGETABLE** or **CASSEROLE**.
- 4 Enter recipe cook temperature.
- 5 **Enter maximum recipe or package cook time.**
- 6 Select **START**. Cook time will automatically convert to shorter time and display on control screen.
- 7 You must always preheat the oven. Wait for preheat signal and message on display to **"PUT FOOD IN OVEN"** before placing food in oven.
- 8 Select **START**. Start will not appear on control screen until door is opened and food is put in oven. You must select **START** to start cooking. Countdown of cook time will begin.  
**Note:** Food may be checked at any time by opening the door. The microwave and convection fan will turn off and the cooking time countdown will stop while the door is open. All three will resume when the door is closed.
- 9 Check food when prompted and add more time if desired.  
  
After the cooking time has ended, the oven will prompt the user to add **"MORE TIME"** to further cook food if desired. Add additional time by selecting **MORE TIME**. Enter traditional cooking time in minutes and select **START**. Once again, the oven automatically converts the traditional time to the appropriate speedcook time (nearest minute). Press **CLEAR/OFF** pad if food has finished cooking.

Food Type	Food Subcategory	Food Examples	Approximate Time Savings
FrozenFood	Desserts	Frozen: Pies, Cookies, Cobblers	1-1/2 times faster
	MainDishes	Frozen: Entrees, Lasagna, TV Dinners, Pizzas	2 times faster
	Snack/Sides	Frozen: Snacks, Appetizers, Vegetables, French Fries Frozen: Rolls, Biscuits	2 to 3 times faster
Meat	Ham	Ham	1-1/2 times faster
	Pork	Pork Tenderloin, Pork Roast	2-1/2 to 3 times faster
	Beef	Meatloaf, Beef Roast	2-1/2 to 3 times faster
	Lamb Game/Wild	Leg of Lamb Venison	2-1/2 to 3 times faster 2-1/2 to 3 times faster
Veg/Cass	BakedPotato	Baked Potatoes	5 times faster
	Vegetable	Unfrozen: Vegetables (carrots, squash, etc.)	4 times faster
	Casserole	Unfrozen: Meat Casseroles or Lasagna, Unfrozen: Vegetable Casseroles	4 times faster
Poultry/Fish	—	Chicken, Fish, Turkey, Seafood, Cornish Hens	2 to 3 times faster
BakedGoods	—	Cookies, Muffins, Cupcakes, Appetizers, Bar Cookies, Cakes, Fresh Pies, Brownies, Souffles, Cobblers	2 times faster
Breads	QuickBread	Quick Breads such as Corn Bread and Banana Bread	2 times faster
	DoughBread	Yeast Bread, Fresh or Deli Pizzas	3 times faster
	Biscuit/Roll	Biscuits, Sweet Rolls, Dinner Rolls, Breadsticks	3 times faster



## Traditional Roasting Guide

Meats		Minutes/Lb.	Oven Temp.	Internal Temp.	
<b>Beef</b>	Rib, Boneless Rib,	Rare†	22–26	325°F	140°F†
	Top Sirloin	Medium	26–30	325°F	160°F
	(3 to 5 lbs.)	Well	30–34	325°F	170°F
	Beef Tenderloin	Rare†	12–16	325°F	140°F†
		Medium	16–20	325°F	160°F
<b>Pork</b>	Bone-in, Boneless (3 to 5 lbs.)		30–35	325°F	160°F
<b>Ham</b>	Canned, Butt, Shank (3 to 5 lbs., fully cooked)		23–28	325°F	140°F
<b>Lamb</b>	Bone-in, Boneless (3 to 5 lbs.)	Medium	25–30	325°F	160°F
		Well	30–35	325°F	170°F
<b>Poultry</b>	Whole Chicken (2-1/2 to 3-1/2 lbs.)		24–26	325°F	180°–185°F
	Cornish Hens, Unstuffed (1 to 1-1/2 lbs.)		40–45	325°F	180°–185°F
	Stuffed (1 to 1-1/2 lbs.)		45–50	325°F	180°–185°F
	Duckling (4 to 5 lbs.)		28–32	350°F	180°–185°F
	Turkey, whole*				
	Unstuffed (10 to 16 lbs.)		14–18	325°F	180°–185°F
Unstuffed (18 to 24 lbs.)		8–12	325°F	180°–185°F	
	Turkey Breast (4 to 6 lbs.)		23–27	325°F	170°F

\* Stuffed birds are not recommended for speedcooking.

† The U.S. Department of Agriculture says “Rare beef is popular, but you should know that cooking it to only 140°F means some food poisoning organisms may survive.” (Source: *Safe Food Book. Your Kitchen Guide.* USDA Rev. June 1985.)

## Tips for Speed Broiling

Your oven with Trivection™ technology has the flexibility to broil like a traditional oven or speed broil. Speed broiling of meats is approximately twice as fast as traditional broiling.

**Speed broiling must be done with the door closed.**

**The oven must be preheated when speed broiling.**

Turning meat and poultry is optional in speed broil. However, use tongs if turning meat to prevent piercing the meat and losing juices.

Speed broil will generally produce good results for medium to well done meats. If rare meat is desired, use traditional broil.

Cooking times will vary depending on the cut of meat. Check for doneness at minimum time using a meat thermometer. **DO NOT leave a meat thermometer in the meat or poultry while cooking with Trivection technology since this may damage the thermometer.**

For best results, use a pan designed for broiling.

Evenly slit fat around the outside edges of steaks and chops to prevent curling during broiling.

If desired, marinate meats before broiling. Brush with sauces during the last five minutes only.

## Using the Trivection™ oven.

### How to Set the Oven for Speed Broiling

Heat is provided by the upper element and microwave. Air is circulated with the reversing fan system. Oven door must be closed. **Ideal for broiling foods to medium to well done doneness levels two times faster than traditional broil.**

- 1 Select **SPEEDCOOK** from the main menu.
- 2 Select **SPEED BROIL**.
- 3 Enter traditional broil time for first side (using maximum time if a range is given). Reference the chart below.  
**NOTE:** If you don't plan to turn the food over, enter the total broil time.
- 4 Select **START** to preheat oven. Cook time will automatically convert to shorter time and display on control screen.
- 5 **You must preheat the oven.** Wait for the preheat signal and message on display to **"PUT FOOD IN OVEN"** before placing food in oven.

- 6 Select **START**. Start will not appear on control screen until door is opened and food is put in oven. Countdown of cook time will begin.

**NOTE:** Food may be checked at any time by opening the door. The microwave and convection fan will turn off and the time countdown will stop while the door is open. They will resume when the door is closed.

- 7 Check food when prompted. Turn food as needed and add more time for the second side.

After the cooking time has ended, the oven will prompt the user to add **"MORE TIME"** to further cook food if desired. Add additional time by selecting **MORE TIME**. Enter traditional cooking time in minutes and select **START**. Once again, the oven automatically converts the traditional time to the appropriate speedcook time (nearest minute). Press **CLEAR/OFF** pad if food has finished cooking.

### Traditional Broiling Guide for Speed Broiling

Food	Quantity and/or Thickness	Rack Position	First Side Time, Min	Second Side Time, Min.	Comments
<b>Ground Beef</b>	2 lb. (8 patties) 1/2" to 3/4" thick	D	10	8	Space evenly on pan. Up to 8 patties take about the same time.
<b>Beef Steaks</b>					
Med. Rare	1" thick	D	11	10	Steaks less than 1" thick cook through before browning. Cook first side to desired brownness. Then turn and finish second side to desired doneness. Slash fat.
Medium	(about 2–3 lbs.)	D	13	12	
Med. Rare	1-1/2" thick	D	14	13	
Medium	(about 3–4 lbs.)	D	17	16	
<b>Chicken</b>					
	1 whole, cut up, about 3 to 3-1/2 lbs.	C	35	25	Brush each side with melted butter. Broil skin-side down first.
	6 Bone-in breasts, 12 to 14 oz. each	C	28	26	
	6 Boneless breasts, 5 to 7 oz. each	D	12	10	
<b>Fish</b>					
	4 Fillets, 1/4" to 1/2" thick	E	7	Do not turn over.	Place skin side down. Brush with olive oil.
	4 Fillets, 3/4" to 1" thick	D	14	Do not turn over.	Place skin side down. Brush with olive oil.
	4 Steaks, 1" thick (about 2 lbs.)	D	10	10	Brush with lemon butter before and during cooking, if desired.
<b>Lobster Tails</b>	2–4, 8 to 12 oz. each	C	18–20	Do not turn over.	Cut through back of shell. Spread open. Brush with melted butter after half of broiling time.
<b>Pork Chops</b>					
	6 Chops, 1/2" thick (about 2 lbs.)	E	9–11	7	Slash fat.
	6 Chops, 1" thick (about 4 lbs.)	D	23	14	Slash fat.
<b>Ham Slices</b>	2 precooked, 1/2" thick	D	13	6	
<b>Lamb Chops</b>					
Medium	4 Chops, 1-1/2" thick,	D	12	9	Slash fat.
Well Done	about 1-1/2 lbs.	D	14	12	

# Using the defrost feature.

The defrost feature allows you to thaw food for a set amount of time.

## Cookware/Tips for Defrosting

For best results, remove food from packaging and **place on broil pan and grid**. If food is left in packaging, slit, pierce or vent to prevent heat buildup.

Place food in the oven according to the *Defrosting Guide*.

You can use all cookware/containers that are oven safe or microwave-safe. Arcing is the microwave term for sparks in the oven. Be sure there is at least 1 inch of space between metal surfaces—pans, wall of cavity, aluminum foil—to prevent arcing. **Dishes with metallic trim should not be used as arcing may occur. Remove metal twist ties from paper or plastic bags before placing them in the oven.**

Do not completely surround food with metal and/or foil.

Plastic storage containers should be uncovered before defrosting.

Foods that spoil easily should not be allowed to sit out for more than one hour after defrosting. Room temperature promotes the growth of harmful bacteria.

Use caution when removing metal pans and stoneware after defrosting. They may become very warm, and you may need to use a potholder.

For more even defrosting, turn food over, separate and rearrange when prompted. Be sure large meats are completely defrosted before cooking. See the *Defrosting Guide* for additional comments.

When defrosted, food should be cool but softened in all areas. If still slightly icy, return to the oven very briefly, or let it stand a few minutes.

## How to Set the Oven for Defrost

- 1 Place food in oven.
- 2 Select **FEATURE** from main menu.
- 3 Select **DEFROST**.
- 4 Enter the defrost time in hours and/or minutes. Reference the chart on the next page.
- 5 Select **START**.

**NOTE:** Food may be checked at any time by opening the door. The microwave and convection fan will turn off and the defrost time countdown will stop while the door is open. They will resume when the door is closed.

- 6 Check food and turn over when prompted. Add more time if desired.

*After the defrost time has ended, the oven will prompt the user to add "**MORE TIME**." Add additional time by selecting **MORE TIME**. Enter time in minutes. Press **CLEAR/OFF** pad if food has finished defrosting.*

## Using the defrost feature.

### Defrosting Guide

Food	Rack Position	Defrost Time	Stand Time	Comments
<b>Ground Meat</b> 1 lb. more than 1 lb.	D C	9 min. 9 min./lb.	5 min. 10 min.	Turn over, break apart and remove defrosted meat at signals.
<b>Hamburger Patties</b>	D	9 min./lb.	5 min.	Turn over and separate at signals.
<b>Stew Meat</b>	D	9 min./lb.	10 min.	Turn over and break apart at signals.
<b>Steaks and Chops</b>	B	10–12 min./lb.	10 min.	Turn over and separate at signals. Shield warm areas with small pieces of foil.
<b>Roasts</b> Boneless and Bone-in	A	8–9 min./lb.	30 min.	Turn over at signals. Shield warm areas with small pieces of foil.
<b>Chicken</b> Pieces, Boneless Pieces, Bone-in Whole	C C B	9 min./lb. 9 min./lb. 9–10 min./lb.	10 min. 10 min. 20 min.	Turn over and separate at signals. Rinse under cold water after stand. Shield ends of legs and wings with foil. Turn over at signals. Rinse under cold water after stand.
<b>Turkey Breast</b>	B	10 min./lb.	30 min.	Turn over at signals. Shield warm areas with foil.
<b>Cornish Hens</b>	C	8 min./lb.	30 min.	Shield ends of legs with foil. Turn over at signals. Rinse under cold water after stand time.
<b>Duck</b>	B	9–10 min./lb.	30 min.	Shield ends of legs with foil. Turn over at signals. Rinse under cold water after stand time.
<b>Fish</b> Fillet and Steaks Whole	C C	6–7 min./lb. 8 min./lb.	10 min. 10 min.	Turn over and rearrange at signals. Shield warm areas with foil. Let stand in cold water.
<b>Seafood</b> Shrimp and Scallops  Lobster Tails	D  C	6 min./lb.  7 min./each	10 min.  15 min.	Separate at signals. Rinse under cold water after stand. Shield tail ends with foil. Turn over at signals. Let stand in cold water.

# Using traditional bake and roast.

ge.com

To avoid possible burns, place the racks in the desired position before you turn the oven on.

## Aluminum Foil

Do not use aluminum foil on the bottom of the oven.

Never entirely cover a rack with aluminum foil. This will disturb the heat circulation and result in poor baking.

A smaller sheet of foil may be used to catch a spillover by placing it on a lower rack several inches below the food.

## Preheating and Pan Placement for Baking

Preheat the oven if the recipe calls for it. To preheat, set the oven at the correct temperature. Preheating is necessary for good results when baking cakes, cookies, pastry and breads.

Baking results will be better if baking pans are centered in the oven as much as possible. Pans should not touch each other or the walls of the oven. If you need to use two racks, use **CONV MULTI** mode described in *Using the convection modes* section for best results, placing food on racks A and D (B and E for lower oven on double oven models).

**NOTE:** On double wall ovens, the rack design is unique for the upper Trivection™ oven. Due to this, the upper oven racks and the lower oven racks are not interchangeable.

Type of Food	Rack Position	
	Trivection™ 30" Oven	Lower 30" Oven
Frozen pies (on cookie sheet)	B or C	C or D
Angel food cake	A	A
Bundt or pound cakes	B	B
Biscuits, muffins, brownies, cookies, cupcakes, layer cakes, pies	B or C	C or D
Casseroles	B or C	C or D

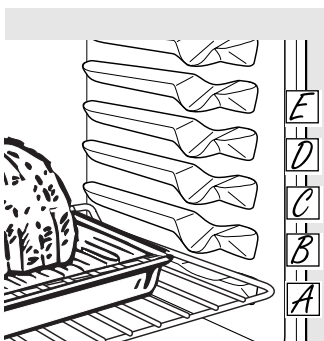

## How to Set the Oven for Baking or Roasting

- 1 Select **BAKE**. Select upper oven or lower oven on double oven models.
- 2 Press the number pads to set the desired temperature.
- 3 Select **START**. The display will show the changing temperature (starting at 100°F). The display starts changing once the temperature reaches 100°F.
- 4 Check food for doneness at minimum time on recipe. Cook longer if necessary.
- 5 Press the **CLEAR/OFF** pad when cooking is complete.

**NOTE:** A cooling fan may automatically turn on and off to cool internal parts. This is normal, and the fan may continue to run even after the oven is turned off.

Safety Instructions

Operating Instructions

Care and Cleaning

Troubleshooting Tips

Consumer Support

## Using the traditional timed baking and roasting features.

(on some models)

On double oven models, you can use timed baking in one oven while using self-clean in the other; you can also use timed baking in both ovens at the same time.

**NOTE:** Foods that spoil easily—such as milk, eggs, fish, stuffings, poultry and pork—should not be allowed to sit for more than 1 hour before or after cooking. Room temperature promotes the growth of harmful bacteria. Be sure that the oven light is off because heat from the bulb will speed harmful bacteria growth.

### How to Set an Immediate Start and Automatic Stop

The oven will turn on immediately and cook for a selected length of time. At the end of the cooking time, the oven will turn off automatically.

Make sure the clock shows the correct time of day.

- 1 Select **BAKE**. Select upper oven or lower oven on double oven models.
- 2 Using the number pads, enter the desired temperature.
- 3 Select **OPTIONS**.
- 4 Select **TIMED BAKE**.

**NOTE:** The time countdown will not start until after the oven is preheated.

- 5 Using the number pads, enter the desired baking time. The oven temperature and the cooking time that you entered will be displayed.

- 6 Select **ENTER**. This tells the oven that you have finished setting it.

- 7 Select **START**.

The display will show the changing temperature (starting at 100°F) and the cooking time. The display starts changing once the temperature reaches 100°F.

The oven will continue to cook for the programmed amount of time, then shut off automatically, unless the **WARM** feature was set. See the *Using the proof, warmer and warm features* section.

After the cooking time has ended, the oven will prompt the user to add "**MORE TIME**" to further cook food if desired. Add additional time by selecting **MORE TIME**. Enter traditional cooking time in minutes and select **START**. Press **CLEAR/OFF** pad if food has finished cooking.

### How to Set a Delayed Start and Automatic Stop

You can set the oven control to delay-start the oven, cook for a specific length of time and then turn off automatically.

Make sure the clock shows the correct time of day.

- 1 Select **BAKE**. Select upper oven or lower oven on double oven models.
- 2 Using the number pads, enter the desired temperature.
- 3 Select **OPTIONS**.
- 4 Select **TIMED BAKE**.
- 5 Using the number pads, enter the desired baking time.

**NOTE:** The time countdown will not start until after the oven is preheated.

- 6 Select **ENTER**.
- 7 Select **OPTIONS**.
- 8 Select **DELAY BAKE**.
- 9 Using the number pads, enter the time of day you want the oven to turn on and start cooking.

- 10 Select **ENTER**.

- 11 Select **START**.

If you would like to check the times you have set, select **REVIEW TIMES**. You have the option to see delay time, clock, bake time or timer.

When the oven turns on at the time of day you have set, the display will show the changing temperature (starting at 100°F) and the cooking time. The display starts changing once the temperature reaches 100°F.

The oven will continue to cook for the programmed amount of time. After the cooking time has ended, the oven will prompt the user to add "**MORE TIME**" to further cook food if desired. Add additional time by selecting **MORE TIME**. Enter traditional cooking time in minutes and select **START**. Press **CLEAR/OFF** pad if food has finished cooking. The oven will turn off automatically, unless the **WARM** feature was set. See the *Using the proof, warmer and warm features* section.

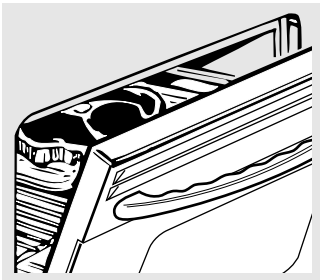

## How to Set the Oven for Broiling

Leave the door open to the broil stop position. The door stays open by itself, yet the proper temperature is maintained in the oven.

**NOTE:** Food can be broiled with the door open or closed. However, if the door is closed, the food may not brown as well because the oven heating element will cycle on and off.

- 1 Select **BROIL**.
- 2 Select **HI** for high broil or **LO** for low broil. **LO** is used to broil thicker cuts of meat without over-browning them.
- 3 Select **START**. We recommend preheating for 5 minutes with the door closed whether you broil food with the door open or closed.

- 4 Place the meat or fish on a broiler grid in a broiler pan designed for broiling.
- 5 Follow suggested rack positions in the *Broiling Guide*.

The size, weight, thickness, starting temperature and your preference of doneness will affect broiling times. This guide is based on meats at refrigerator temperature.

- 6 When broiling is finished, press the **CLEAR/OFF** pad.

**NOTE:** The oven will automatically turn off after 3 hours of continuous broil.

## Broiling Guide

Food	Quantity and/or Thickness	Rack Position*	First Side Time, Min	Second Side Time, Min.	Comments
<b>Ground Beef</b>	2 lb. (8 patties) 1/2" to 3/4" thick	D	10	8	Space evenly on pan. Up to 8 patties take about the same time
<b>Beef Steaks</b>	1" thick (about 2–3 lbs.)	D	11	10	Steaks less than 1" thick cook through before browning. Cook first side just to turn meat color then finish second side to desired doneness. Slash fat.
		D	13	12	
	1 1/2" thick (about 3–4 lbs.)	D	14	13	
		D	17	16	
<b>Chicken</b>	1 whole, cut up, about 3 to 3-1/2 lbs.	C	35	25	Brush each side with melted butter. Broil skin-side down first.
	6 Bone-in breasts, 12 to 14 oz. each	C	28	26	
	6 Boneless breasts, 5 to 7 oz. each	D	12	10	
<b>Fish</b>	4 Fillets, 1/4" to 1/2" thick	E	7	Do not turn over.	Place skin side down. Brush with olive oil.
	4 Fillets, 3/4" to 1" thick	E	14	Do not turn over.	Place skin side down. Brush with olive oil.
	4 Steaks, 1" thick (about 2 lbs.)	E	12	12	Brush with lemon butter before and during cooking, if desired.
<b>Lobster Tails</b>	2–4, 8 to 12 oz. each	C	18–20	Do not turn over.	Cut through back of shell. Spread open. Brush with melted butter after half of broiling time.
<b>Pork Chops</b>	6 Chops, 1/2" thick (about 2 lbs.)	E	9–11	7	Slash fat.
	6 Chops, 1" thick (about 4 lbs.)	D	23	14	
<b>Ham Slices</b>	2 precooked, 1/2" thick	D	13	6	
<b>Lamb Chops</b>	4 Chops, 1-1/2" thick, about 1-1/2 lbs.	D	12	9	Slash fat.
		D	14	12	

\* NOTE: For double wall ovens, when using the lower oven, move up 1 rack position. Broil times may be faster on the lower oven.

## Using the convection modes.

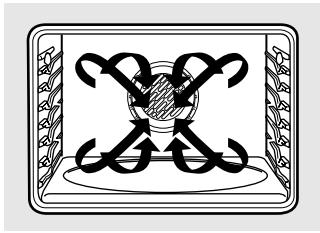

### Convection Fan

In a convection oven, a fan circulates hot air over, under and around the food.

This circulating hot air is evenly distributed throughout the oven cavity. As a result, foods are evenly cooked and browned—often in less time with convection heat.

**NOTE:** The convection fan may cycle on and off and change direction while cooking to best distribute hot air in the oven. The convection oven fan shuts off when the oven door is opened.

**DO NOT** leave the door open for long periods of time while using convection cooking or you may shorten the life of the convection heating element.

### 1-Rack Convection Baking

The convection fan circulates the heated air evenly over and around the food using the bake and broil elements.

When convection baking with only 1 rack, use **CONV 1 RACK** and for best results place the rack on shelf B or C in the Trivection™ oven, or shelf C or D in the lower oven on double oven models, at the center of the oven. Cook times may decrease, so food should be checked earlier than package directions to make sure that it does not overcook.

Ideal for cooking large casseroles and lasagna with good results.

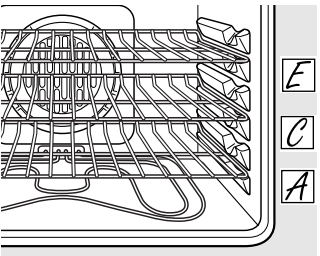

Multi-rack position, Trivection™ Oven.

### Multi-Rack Convection Baking

Because heated air is circulated evenly throughout the oven, foods can be baked with excellent results using multiple racks.

The amount of time required for multi-rack baking may increase slightly for some foods, but overall time is saved because two to three times as much food is cooked at once. Cookies, muffins, biscuits and other quick breads give good results with multi-rack baking.

To cook food on more than one rack in convection bake, use **CONV MULTI**.

#### Trivection™ Oven

When baking on 3 racks, place one rack in the first (A) position, one in the third (C) position and one in the 5th (E) position.

#### Lower Oven

When baking on 3 racks, place one rack in the second (B) position, one in the fourth (D) position and one in the 6th (F) position.

**NOTE:** On double wall ovens, the rack design is unique for the upper Trivection™ oven. Due to this, the upper oven racks and the lower oven racks are not interchangeable.

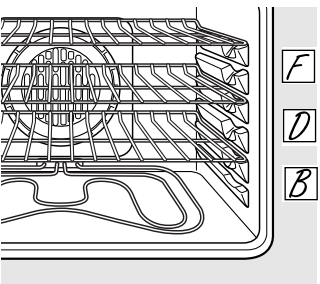

Multi-rack position, lower oven.

### Auto Recipe™ Conversion

When convection baking, the Auto Recipe™ Conversion feature automatically reduces the set traditional baking temperature by the recommended 25°F. See Auto Recipe™ Conversion in the Settings section.

- Use pan size recommended.
- Some package instructions for frozen casseroles or main dishes have been developed using commercial convection ovens. For best results in this oven, preheat the oven and use the traditional temperature on the package.



### Convection Roast

■ Good for large tender cuts of meat, uncovered.

The convection fan circulates the heated air evenly over and around the food. Meat and poultry are browned on all sides as if they were cooked on a rotisserie. The heated air seals in juices quickly for a moist and tender product while, at the same time, creating a rich golden brown exterior.

When you are convection roasting, it is important that you use a broiler pan and grid designed for broiling for best convection roasting results. The pan is used to catch grease spills and the grid is used to prevent grease spatters.

### Cookware for Convection Cooking

*When baking cookies, you will get the best results if you use a flat cookie sheet instead of a pan with low sides.*

Before using your convection oven, check to see if your cookware leaves room for air circulation in the oven. If you are baking with several pans, leave space between them. Also, be sure the pans do not touch each other or the walls of the oven.

#### Paper and Plastic

Heat-resistant paper and plastic containers that are recommended for use in regular ovens can be used for convection baking, but shouldn't be used at temperatures higher than the temperature recommendation of the cookware manufacturer.

#### Metal and Glass

Any type of cookware will work in your convection oven. However, metal pans heat the fastest and are recommended for convection baking.

■ Glass or ceramic pans cook more slowly.

For recipes like oven-baked chicken, use a pan with low sides. Hot air cannot circulate well around food in a pan with high sides.

### How to Set the Oven for Convection Baking or Roasting

- 1 Select **CONVECTION**.
- 2 On double oven models, select upper or lower oven.
- 3 Select **CONV MULTI** for multi-rack convection baking. This mode is used for cooking food items on more than one rack (i.e., 2, 3 or more racks) at the same time in convection bake. See *Multi-Rack Baking* section for more information. Select **CONV 1-RACK** for one rack convection baking. This mode is used for cooking food items on only one rack in convection bake. Select **CONVROAST** for convection roasting.

- 4 Press the number pads to set the desired oven temperature.
- 5 Select **START**.

When the oven starts to heat, the changing temperature, starting at 100°F, will be displayed. When the oven reaches the temperature you set, 3 beeps will sound.

To change the oven temperature, select **HOME**. Select **CONVECTION** and the desired convection mode. Then use the number pads to set the new temperature and select **START**.

- 6 Press **CLEAR/OFF** pad when finished.

■ You will hear a fan while cooking with convection. The convection fan will stop when the door is opened, but the heat will not turn off.

■ You may hear the oven clicking during baking. This is normal.

## Using the timed features for convection cooking.

On double oven models, you can use timed baking or roasting in one oven while using self-clean in the other; you can also use timed baking or roasting in both ovens at the same time.

You will hear a fan while cooking with these features. The convection fan will stop when the door is opened, but the heat will not turn off.

**NOTE:** Foods that spoil easily—such as milk, eggs, fish, stuffings, poultry and pork—should not be allowed to sit for more than 1 hour before or after cooking. Room temperature promotes the growth of harmful bacteria. Be sure that the oven light is off because heat from the bulb will speed harmful bacteria growth.

### How to Set an Immediate Start and Automatic Stop

The oven will turn on immediately and cook for a selected length of time. At the end of the cooking time, the oven will turn off automatically.

Make sure the clock shows the correct time of day.

- 1 Select **CONVECTION**.
- 2 On double oven models, select upper or lower oven.
- 3 Select **CONV MULTI** for multi-rack convection baking. This mode is used for cooking food items on more than one rack (i.e., 2, 3 or more racks) at the same time in convection bake. See *Multi-Rack Baking* section for more information. Select **CONV 1-RACK** for one rack convection baking. This mode is used for cooking food items on only one rack in convection bake. Select **CONVROAST** for convection roasting.
- 4 Press the number pads to set the desired oven temperature.
- 5 Select **OPTIONS**.
- 6 Select **TIMED BAKE**.
- 7 Using the number pads, enter the desired convection cooking time. The oven temperature and the cooking time that you entered will be displayed.

**NOTE:** The time countdown will not start until after the oven is preheated.

8 Select **ENTER**. This tells the oven that you have finished setting it.

9 Select **START**.

When the oven starts to heat, the changing temperature, starting at 100°F, will be displayed. When the oven reaches the temperature you set, 3 beeps will sound.

The oven will continue to cook for the programmed amount of time, then shut off automatically, unless the **WARM** feature was set. See the *Settings* section.

After the cooking time has ended, the oven will prompt the user to add "**MORE TIME**" to further cook food if desired. Add additional time by selecting **MORE TIME**. Enter traditional cooking time in minutes and select **START**. Press **CLEAR/OFF** pad if food has finished cooking.

## How to Set a Delayed Start and Automatic Stop

You can set the oven control to delay-start the oven, cook for a specific length of time and then turn off automatically.

Make sure the clock shows the correct time of day.

- 1 Select **CONVECTION**.
- 2 On double oven models, select upper or lower oven.
- 3 Select **CONV MULTI** for multi-rack convection baking. This mode is used for cooking food items on more than one rack (i.e., 2, 3 or more racks) at the same time in convection bake. See *Multi-Rack Baking* section for more information.
 

Select **CONV 1-RACK** for one rack convection baking. This mode is used for cooking food items on only one rack in convection bake.

Select **CONVROAST** for convection roasting.
- 4 Press the number pads to set the desired oven temperature.
- 5 Select **OPTIONS**.
- 6 Select **TIMED BAKE**.
- 7 Using the number pads, enter the desired convection cooking time.

**NOTE:** The time countdown will not start until after the oven is preheated.

- 8 Select **ENTER**.
- 9 Select **OPTIONS**.
- 10 Select **DELAY BAKE**.
- 11 Using the number pads, enter the time of day you want the oven to turn on and start cooking.
- 12 Select **ENTER**.
- 13 Select **START**.

If you would like to check the times you have set, select **REVIEW TIMES**. You have the option to see delay time, clock, cook time or timer.

When the oven starts to heat, the changing temperature, starting at 100°F, will be displayed. When the oven reaches the temperature you set, 3 beeps will sound.

The oven will continue to cook for the programmed amount of time. After the cooking time has ended, the oven will prompt the user to add **"MORE TIME"** to further cook food if desired. Add additional time by selecting **MORE TIME**. Enter traditional cooking time in minutes and select **START**. Press **CLEAR/OFF** pad if food has finished cooking. The oven will turn off automatically, unless the **WARM** feature was set. See the *Settings* section.

Press the **CLEAR/OFF** pad to clear the display.

## Convection Roasting Guide

Meats		Minutes/Lb.	Oven Temp.	Internal Temp.		
<b>Beef</b>	Rib, Boneless Rib, Top Sirloin (3 to 5 lbs.)	Rare Medium Well	20–24 24–28 28–32	325°F 325°F 325°F	140°F† 160°F 170°F	
	Beef Tenderloin	Rare Medium	10–14 14–18	325°F 325°F	140°F† 160°F	
	<b>Pork</b>	Bone-in, Boneless (3 to 5 lbs.)	23–27	325°F	170°F	
	Chops (1/2 to 1" thick)	2 chops 4 chops 6 chops	30–35 total 35–40 total 40–45 total	325°F 325°F 325°F	170°F 170°F 170°F	
<b>Ham</b>	Canned, Butt, Shank (3 to 5 lbs. fully cooked)		14–18	325°F	140°F	
<b>Lamb</b>	Bone-in, Boneless (3 to 5 lbs.)	Medium	17–20	325°F	160°F	
		Well	20–24	325°F	170°F	
<b>Seafood</b>	Fish, whole (3 to 5 lbs.)		30–40 total	400°F		
	Lobster Tails (6 to 8 oz. each)		20–25 total	350°F		
<b>Poultry</b>	Whole Chicken (2½ to 3½ lbs.)		24–26	350°F	180°–185°F	
	Cornish Hens Unstuffed (1 to 1½ lbs.) Stuffed (1 to 1½ lbs.)		50–55 total 55–60 total	350°F 350°F	180°–185°F 180°–185°F	
		Duckling (4 to 5 lbs.)		24–26	325°F	180°–185°F
	Turkey, whole*	Unstuffed (10 to 16 lbs.)		8–11	325°F	180°–185°F
		Unstuffed (18 to 24 lbs.)		7–10	325°F	180°–185°F
	Turkey Breast (4 to 6 lbs.)		16–19	325°F	170°F	

\* Stuffed birds generally require 30–45 minutes additional roasting time. Shield legs and breast with foil to prevent overbrowning and drying of skin.

† The U.S. Department of Agriculture says "Rare beef is popular, but you should know that cooking it to only 140°F means some food poisoning organisms may survive." (Source: *Safe Food Book. Your Kitchen Guide. USDA Rev. June 1985.*)

## Recipes.

You can preset up to six temperature/cooking time combinations with this function. You can then bake, convection bake/roast or speed bake any of these six favorite recipes without choosing settings each time.

### NOTES:

You cannot program broil, defrost, dehydrate, warmer, proof, speed broil, Delay Bake or self-clean in **RECIPES**.

Your oven will remember **FAVORITES** that have been programmed even after a power outage.

**The cooking time you enter does not include preheat time. The oven will begin to count down the cooking time after the oven has completed preheating. At the preheat tone, put your food in the oven.**

**FAVORITES** are only available on the upper oven of a double wall oven.

### To Program a New FAVORITE

- 1 Select **RECIPES**.
- 2 Select an available **FAVORITE**. An available **FAVORITE** will not have a block before and after it. A **FAVORITE** that has already been programmed will have a block before and after it. For example: ■FAVORITE1■.
- 3 Select the desired cooking mode. The available options are **BAKE**, **CONVECTION** (both convection bake modes and convection roast) and **SPEED BAKE** (all speed bake categories and sub-categories).
- 4 Use the number pads to enter the cooking temperature.
- 5 Use the number pads to enter the cooking time. Select **ENTER** when finished.
- 6 The control display will show the programmed cooking mode, temperature and time for the **FAVORITE**. Select **SAVE** if the information displayed is correct.
- 7 Select **START** to begin cooking with the recipe that was just saved. If you do not want to start the recipe now, touch the **CLEAR/OFF** pad.

### To Use a FAVORITE

- 1 Select **RECIPES**.
- 2 Select an available **FAVORITE**. An available **FAVORITE** will not have a block before and after it. A **FAVORITE** that has already been programmed will have a block before and after it. For example: ■FAVORITE1■.
- 3 The control display will show the programmed cooking mode, temperature and time for the **FAVORITE** selected. Select **START** to begin cooking with the selected recipe.

### To Change or Replace a FAVORITE

- 1 Select **RECIPES**.
- 2 Select the desired **FAVORITE** recipe. A **FAVORITE** that has already been programmed will have a block before and after it. For example: ■FAVORITE1■.
- 3 The control display will show the programmed cooking mode, temperature and time for the **FAVORITE**. Select **REPLACE**.
- 4 Select the desired cooking mode. The available options are **BAKE**, **CONVECTION** (both convection bake modes and convection roast) and **SPEED BAKE** (all speed bake categories and sub-categories).
- 5 Use the number pads to enter the cooking temperature.
- 6 Use the number pads to enter the cooking time. Select **ENTER** when finished entering the cooking time.
- 7 The control display will show the programmed cooking mode, temperature and time for the **FAVORITE**. Select **SAVE** if the information displayed is correct.
- 8 Select **START** to begin cooking with the recipe that was just saved. If you do not want to start the recipe now, touch the **CLEAR/OFF** pad.

# Using the proof, warmer and warm features.

ge.com

The proofing feature maintains a warm environment useful for rising yeast-leavened products.

## How to Set the Oven For Proof

**NOTE:** For best results, cover the dough with a cloth or with greased plastic wrap (the plastic may need to be anchored underneath the container so the oven fan will not blow it off).

- 1 Place the covered dough in the oven on rack B or C.
- 2 Select **FEATURES**, then **MORE**, then **PROOF** and then **START**.

The interior oven lights turn on and remain on during proofing.

The proofing feature automatically provides the optimum temperature for the proofing process, and therefore does not have a temperature adjustment.

- 3 Set the **KITCHEN TIMER** for the minimum proof time.

- 4 When proofing is finished, press the **CLEAR/OFF** pad.

- To avoid lowering the oven temperature and lengthening proofing time, do not open the oven door unnecessarily.
- Check bread products early to avoid over-proofing.

### NOTE:

- Do not use the proofing mode for warming food or keeping food hot. The proofing oven temperature is not hot enough to hold foods at safe temperatures. Use the **WARMER** feature to keep hot food warm.
- Proofing will not operate when oven is above 125°F. "OVEN TOO HOT" will show in the display.

## How to Set the Oven For Warmer

The warmer feature can be activated independently to keep hot, cooked foods warm. This feature is not designed to reheat cold food.

To use this feature, select **FEATURES**, then **WARMER**, then **START**.

**NOTE:** On double oven models, select upper or lower oven. Then select **START**.

### To Crisp Stale Items

- Place food in low-sided dishes or pans.
- For best results, place the food items in a single layer. Do not stack.
- Leave them uncovered.
- Check crispness after 20-30 minutes. Add time as needed.

### IMPORTANT NOTES:

- Food should be kept hot in its cooking container or transferred to a heat-safe serving dish.

- For moist foods, cover them with an oven-safe lid or aluminum foil.
- Fried or crisp foods do not need to be covered, but can become too dry if warmed for too long.
- Repeated opening of the door allows the hot air to escape and the food to cool.
- Allow extra time for the temperature inside the oven to stabilize after adding items.
- With large loads it may be necessary to cover some of the cooked food items.
- Remove serving spoons, etc., before placing containers in the oven.
- Do not use plastic containers, lids or plastic wrap.

**CAUTION:** Plastic containers, lids or plastic wrap will melt if placed in the oven. Melted plastic may not be removable and is not covered under your warranty.

## How to Set the Oven For Warm

The warm feature (cook and hold) automatically keeps hot cooked foods warm for up to 3 hours after a **TIMED BAKE** is finished.

To turn this feature **ON** or **OFF**, select **FEATURES**, then **MORE**, then **WARM**.

If the blocks before and after **WARM** are lit, the feature is **ON**. If there are no blocks lit before and after **WARM**, the feature is **OFF**.

Safety Instructions

Operating Instructions

Care and Cleaning

Troubleshooting Tips

Consumer Support

## Using the self-cleaning oven.

The oven door must be closed and all controls must be set correctly for the cycle to work properly.

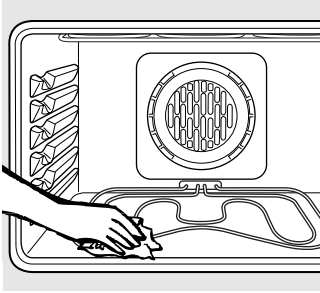

Wipe up heavy soil on the oven bottom. (appearance may vary)

### Before a Clean Cycle

We recommend venting your kitchen with an open window or using a ventilation fan or hood during the first self-clean cycle.

Remove broiler pan, broiler grid, all cookware and any aluminum foil from the oven.

The shiny, silver-colored oven racks (on some models) can be self-cleaned, but they will darken, lose their luster and become hard to slide.

Do not use abrasives or oven cleaners. Clean the top, sides and outside of the oven door with soap and water.

Make sure the oven light bulb cover is in place and the oven light is off.

**NOTE:** See *Cleaning the Oven Door* in the *Care and Cleaning* section for instructions on how to clean the inner door outside the gasket. This area is not cleaned during the self-clean cycle.

**IMPORTANT:** The health of some birds is extremely sensitive to the fumes given off during the self-cleaning cycle of any oven. Move birds to another well-ventilated room.

- On double oven models, you can set a clean cycle in both ovens. However, the last oven set will automatically delay its start until the end of the first oven's clean cycle.
- On double oven models, you can use timed baking in one oven and self-clean the other at the same time.

### How to Set the Oven for Cleaning

- 1 Select **FEATURES**.
- 2 Select **SELF CLEAN**. Select upper or lower oven on double oven models.
- 3 Select the desired self clean.
  - A 3-hour self-clean time is recommended when cleaning small, contained spills. A self-clean time of 4 hours or longer is recommended for a dirtier oven.
  - LO** (3 hrs) will self clean the oven for 3 hours.
  - STD** (4 hrs) will self clean the oven for 4 hours.
  - ADJUST TIME** allows oven to be set for any time between 3 and 5 hours. Input the clean time (to nearest 5 minutes) using the number pads and select **ENTER**.

- 4 Select **START**.

The door locks automatically.  will flash until door is locked. The display will show the clean time remaining.

It will not be possible to open the oven door until the temperature drops below the lock temperature and the  (**LOCK**) light goes off.

When the  (**LOCK**) light goes off, you will be able to open the door.

- To stop a clean cycle, press the **CLEAR/OFF** pad. When the  (**LOCK**) light goes off indicating the oven has cooled below the locking temperature, you will be able to open the door.

The oven door must be closed and all controls must be set correctly for the cycle to work properly.

### How to Delay the Start of Cleaning

- 1 Select **FEATURES**.
- 2 Select **SELF CLEAN**. Select upper or lower oven on double oven models.
- 3 Select the desired self clean.  
A 3-hour self-clean time is recommended when cleaning small, contained spills. A self-clean time of 4 hours or longer is recommended for a dirtier oven.  
**LO** (3 hrs) will self clean the oven for 3 hours.  
**STD** (4 hrs) will self clean the oven for 4 hours.  
**ADJUST TIME** allows oven to be set for any time between 3 and 5 hours. Input the clean time (to nearest 5 minutes) using the number pads and select **ENTER**.
- 4 Select **DELAY CLEAN**.
- 5 Using the number pads, enter the time of day you want the clean cycle to start.
- 6 Select **ENTER**.
- 7 Select **START**.

The door locks automatically when you select **START**. The oven will remain locked. The display will show the start time. Once the self-clean cycle starts, it will not be possible to open the oven door until the temperature drops below the lock temperature and the  goes off.

When  goes off, you will be able to open the door.

**NOTE:** On double oven models, you can set a delay clean in both ovens. However, the second oven set will automatically delay the start of cleaning until the end of the first oven's clean cycle.

### After a Clean Cycle

You may notice some white ash in the oven. Wipe it up with a damp cloth after the oven cools.

*If white spots remain, remove them with a soap-filled steel-wool pad and rinse thoroughly with a vinegar and water mixture.*

These deposits are usually a salt residue that cannot be removed by the clean cycle.

If the oven is not clean after one clean cycle, repeat the cycle.

■ You cannot set the oven for cooking until the oven is cool enough for the door to unlock.

■ If the racks become hard to slide, wipe the rack supports with cooking oil.

## Settings.

Your new touch pad control has additional settings that you may choose to use. They remain in the control's memory, even after a power failure.

**NOTE:** If a setting is selected, it will have blocks before and after. For example: **▣ settings ▣**.  
If the setting is not selected, it will not have a block before and after. For example: (settings).

### Clock

The clock must be set to the correct time of day for the automatic oven timing functions to work properly. Note that the time of day cannot be changed during a timed baking or self-cleaning cycle.

- 1 Select **SETTINGS** and then select **CLOCK**.
- 2 Press the number keys to enter the correct time of day.
- 3 Select **ENTER**.

### Clock Options

Your control uses a 12-hour clock. If you prefer to have no clock displayed or a 24-hour military time clock, follow these steps:

- 1 Select **SETTINGS** and then select **CLOCKOPTIONS**.
- 2 Select "12 hour", "24 hour" or "no clock."
- 3 After setting this option, select **HOME**.

**NOTE:** If you select the "no clock" option, you will not be able to use the **Delay Bake** or **Delay Clean** functions.

### 12 Hour Shut Off

With this option, should you forget and leave the oven on, the control will automatically turn the oven off after 12 hours.

**To turn this option ON or OFF:**

- 1 Select **SETTINGS** and then select **MORE**.
- 2 Select **12HOUROFF** to turn the option **ON** or **OFF**.

- 3 After setting this option, select **HOME**.

**NOTE:** On double oven models, this activates this special feature for both ovens.

### Check Food Doneness

To help you adapt to cooking with Trivection™ technology, this option prompts you 3/4 of the way through a speed bake mode so that you can check your food doneness.

**To turn this option ON or OFF:**

- 1 Select **SETTINGS** and then select **MORE**.

- 2 Select **CHECKFOOD** to turn the option **ON** or **OFF**.
- 3 After setting this option, select **HOME**.



## Auto Recipe™ Conversion

When using convection bake, the Auto Recipe™ Conversion feature automatically changes entered traditional baking temperatures to convection baking temperatures. For example, if you enter a regular recipe temperature of 350°F and select **START**, the display will show **Con** and then the converted temperature of 325°F.

**NOTE:** This feature does not change traditional baking times, only traditional baking temperatures.

**To turn this option ON or OFF:**

- 1 Select **SETTINGS** and then select **MORE**.
- 2 Select **CONVTEMP** to turn the option **ON** or **OFF**.
- 3 After setting this option, select **HOME**.

## Tones at the End of a Timed Cycle

At the end of a timed cycle, 3 short beeps will sound followed by one beep every 6 seconds until the **CLEAR/OFF** pad is pressed. This continuous 6-second beep may be canceled.

**To turn the continuous 6-second beep ON or OFF:**

- 1 Select **SETTINGS** and then select **MORE** twice.

- 2 Select **BEEPONCE** to turn the continuous 6-second beep **OFF**. Select **FULL BEEP** to turn the continuous 6-second beep **ON**.
- 3 After setting this option, select **HOME**.

**NOTE:** On double oven models, this cancels the end-of-cycle tone for both ovens.

## Fahrenheit or Celsius Temperature

Your oven control displays the temperature in Fahrenheit (°F), but you may change this to display the temperature in Celsius (°C).

**To change the temperature display between Fahrenheit or Celsius:**

- 1 Select **SETTINGS** and then select **MORE**.

- 2 Select **TEMP°F** to display the temperature in Fahrenheit (°F). Select **TEMP°C** to display the temperature in Celsius (°C).

- 3 After setting this option, select **HOME**.

**NOTE:** On double oven models, the new setting will be displayed for both ovens.

## Tone Volume

This feature allows you to adjust the tone volumes to a more acceptable level. There are three possible volume levels.

**To change the volume level:**

- 1 Select **SETTINGS** and then select **MORE** twice.
- 2 Select **BEEPVOLUME**. Each time the volume level is changed, the tone you hear is an audible indication of the volume level. Select **2 BEEP** for the middle volume level. Select **3 BEEP** for the loudest volume level. Select **1 BEEP** for the quietest volume level.

- 3 After choosing the desired sound level (**1 BEEP**, **2 BEEP** or **3 BEEP**), select **HOME**.

**NOTE:** On double oven models, this changes the tone volume for both ovens.

## Adjust the oven temperature—Do it yourself!

You may find that your new oven cooks differently than the one it replaced. Use your new oven for a few weeks to become more familiar with it. If you still think your new oven is too hot or too cold, you can adjust the temperature yourself.

Do not use thermometers, such as those found in grocery stores, to check the temperature setting of your oven. These thermometers may vary 20–40 degrees.

**NOTE:** This adjustment will only affect baking and roasting temperatures; it does not affect broiling, convection, speedcooking or self-cleaning temperatures. The adjustment will be retained in memory after a power failure.

### To Adjust the Temperature

- 1 Select **SETTINGS**, then **MORE**, then **MORE**, then **± temp**. Select upper or lower oven for double oven models.

The current temperature adjustment will appear in the time and temperature display.

- 2 Select **INCREASE** (cook hotter) or **DECREASE** (cook cooler) to change cooking temperature adjustment in 1° increments. Continue until desired number is displayed.

The oven temperature can be adjusted up to (+) 35°F hotter or (-) 35°F cooler.

- 3 When you have made the adjustment, select **HOME** to go back to the main display. Use your oven as you would normally.

## The type of margarine will affect baking performance!

Most recipes for baking have been developed using high-fat products such as butter or margarine (80% fat). If you decrease the fat, the recipe may not give the same results as with a higher-fat product.

Recipe failure can result if cakes, pies, pastries, cookies or candies are made with low-fat spreads. The lower the fat content of a spread product, the more noticeable these differences become.

Federal standards require products labeled “margarine” to contain at least 80% fat by weight. Low-fat spreads, on the other hand, contain less fat and more water. The high-moisture content of these spreads affect the texture and flavor of baked goods. For best results with your old favorite recipes, use margarine, butter or stick spreads containing at least 70% vegetable oil.

# Using the Sabbath Feature.

(Designed for use on the Jewish Sabbath and Holidays.) (on some models)

ge.com

The Sabbath feature can be used for baking/roasting only. It cannot be used for convection, broil, speedcook, defrost, proof, dehydrate, warm, warmer, self-clean or Delay Bake cooking.

## NOTE:

- The oven light in the lower oven of a double wall oven (on some models) comes on automatically when the door is opened and goes off when the door is closed. The oven light may be turned on prior to the Sabbath by using the oven light keypad or the bulb may be removed in order to keep the light from turning on. See the Oven Light Replacement section to remove the bulb.
- The oven light in the single wall oven and the upper oven of a double wall oven is automatically locked out by the control while using the Sabbath feature. The light cannot be turned on or off by the oven light keypad or by opening or closing the door. If the oven light is on, it will remain on and if the oven light is off, it will remain off while the Sabbath feature is being used.
- If there is a loss of power while using the Sabbath feature, the oven will return to the Sabbath feature when power returns, but the bake settings will need to be reentered.
- The **CLEAR/OFF** pad still works during the Sabbath feature and will clear any active **BAKE** settings.
- The Glass Touch number pad surface is solid and will not depress when pushed. To make sure that any command entered while using Sabbath registers for the Glass Touch, ensure that the entire pad of your finger is squarely over the keypad for two seconds. Make sure not to overlap another pad while touching the desired pad—be especially careful around the **CANCEL** key so that the programmed cooking mode is not exited accidentally.
- The lower wall oven of a double wall oven can not be started or the temperature changed once in the Sabbath feature. However, the lower wall oven can be set before entering the Sabbath feature.

## How to Set for Sabbath Feature in Baking/Roasting

Make sure that the clock shows the correct time of day.

- 1 Select **BAKE**. On double oven models, select upper or lower oven.
- 2 Enter the desired temperature using the number pads and **START** the oven.
- 3 Select **HOME**, then **FEATURES**, then **MORE**.
- 4 Select **SABBATH**. No audible signal will be given and the temperature will disappear from the time and temperature display. The element and oven icons will remain displayed to indicate that the oven is on.

**NOTE:** Selecting **BAKE**, entering a temperature and pressing **START** will clear any programmed Timed Bake and start the new settings.

### Double oven model control screen

*Sabbath*	
↑Bake	
	Start

### Single oven model control screen

*Sabbath*	
Bake	
	Back
	Start

## Using the Sabbath Feature.

(Designed for use on the Jewish Sabbath and Holidays.) (on some models)

### How to Set for Sabbath Feature in Timed Baking/Roasting— Immediate Start and Automatic Stop

Make sure that the clock shows the correct time of day.

- 1 Select **BAKE**.
- 2 On double oven models, select upper or lower oven.
- 3 Using the number pads, enter the desired temperature between 170°F and 550°F. No audible signals will be given and no temperature will be displayed.
- 4 Select **OPTIONS**.
- 5 Select **TIMEDBAKE**. Enter the desired cooking time using the number pads. Note that the cooking time will not start to count down until after preheat is complete. Select **ENTER**. This tells the oven that you have finished setting it.
- 6 Select **START**.
- 7 Select **HOME**, then **FEATURES**, then **MORE**.
- 8 Select **SABBATH**. No audible signal will be given and the temperature will disappear from the time and temperature display. The element and oven icons will remain displayed to indicate that the oven is on and the cooking time will remain displayed.

#### Double oven model control screen

*Sabbath*	
↑Bake	
	<b>Start</b>

#### Single oven model control screen

*Sabbath*	
Bake	
	Back
	<b>Start</b>

**NOTE:** The temperature cannot be changed during a Timed Bake. Selecting bake, entering a temperature and pressing **START** will clear any programmed Timed Bake and start the new settings.

When cooking is finished, **0<sup>HR</sup>:00** will appear in the time and temperature display. Then the **0<sup>HR</sup>:00** along with the element and oven icons will turn off, indicating that the oven has turned **OFF**. The control remains in the Sabbath feature.

### Once in Sabbath Feature, How to Set for Baking/Roasting or Adjust Baking Temperature (upper oven of double wall ovens only)

- 1 Select **BAKE**. No audible signal will be given.
- 2 Using the number pads, enter the desired temperature between 170°F and 550°F. No audible signals will be given and no temperature will be displayed.
- 3 Select **START**. No audible signal will be given.

#### **NOTE:**

- When setting the oven for baking/roasting, the element and oven icons will light after a random delay period of approximately 30 seconds to 1 minute to indicate that the oven is baking/roasting. If the element and oven icons do not appear in the time and temperature display, start again at step 1. The control did not recognize the temperature entered as a valid temperature.
- When adjusting the temperature setting of the oven, the element and oven icons

remain lit to indicate that the oven is still on. If the element and oven icons turn off, start again at step 1. The control did not recognize the temperature entered as a valid temperature.

- The Glass Touch number pad surface is solid and will not depress when pushed. To make sure that any command entered while using Sabbath registers for the Glass Touch, ensure that the entire pad of your finger is squarely over the keypad for two seconds. Make sure not to overlap another pad while touching the desired pad—be especially careful around the **CANCEL** key so that the programmed cooking mode is not exited accidentally.
- The lower wall oven of a double wall oven can not be started or the temperature changed once in the Sabbath feature. However, the lower wall oven can be set before entering the Sabbath feature.

### How to Exit the Sabbath Feature

- 1 Touch the **CLEAR/OFF** pad to make sure that the oven is turned **OFF**. No audible signal will be given.
- 2 Hold the **BACK** key for 3 seconds. No audible signal will be given. This will

take the oven control out of the Sabbath feature. The control will return to the Features menu where **SABBATH** was originally selected. Select **HOME** to return to the main menu on the control display.

## Care and cleaning of the oven.

Be sure electrical power is off and all surfaces are cool before cleaning any part of the oven.

### How to Remove Protective Shipping Film and Packaging Tape

Carefully grasp a corner of the protective shipping film with your fingers and slowly peel it from the appliance surface. Do not use any sharp items to remove the film. Remove all of the film before using the appliance for the first time.

To assure no damage is done to the finish of the product, the safest way to

remove the adhesive from packaging tape on new appliances is an application of a household liquid dishwashing detergent. Apply with a soft cloth and allow to soak.

**NOTE:** The adhesive must be removed from all parts. It cannot be removed if it is baked on.

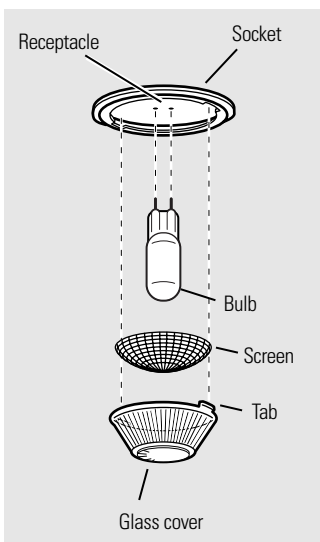

### Oven Light Bulbs

**NOTE:** The glass cover should be removed only when cold. Wearing latex gloves may offer a better grip.

**CAUTION:** Before replacing your oven light bulb, disconnect the electrical power to the oven at the main fuse or circuit breaker panel.

Be sure to let the light cover and bulb cool completely.

**For your safety, do not touch a bulb with bare hands or a damp cloth. It can also shorten the bulb life.**

#### To remove:

- 1 Turn the glass cover counterclockwise 1/4 turn until the tabs of the glass cover clear the grooves of the socket.
- 2 Using gloves or a dry cloth, remove the bulb by pulling it straight out.

#### To replace:

- 1 Use a new 130-volt Halogen bulb, not to exceed 50 watts.
- 2 Using gloves or a dry cloth, remove the bulb from its packaging. **Do not touch the bulb with bare fingers.**

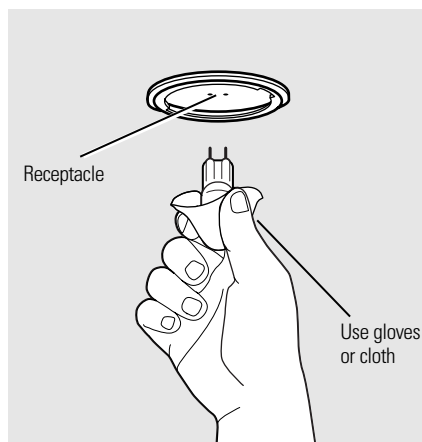

- 3 Push the bulb straight into the receptacle all the way. Then replace the screen. **NOTE:** The screen must be replaced or the life of the bulb will be reduced.
  - 4 Place the tabs of the glass cover into the grooves of the socket. Turn the glass cover clockwise 1/4 turn.
- For improved lighting inside the oven, clean the glass cover frequently using a wet cloth. This should be done when the oven is completely cool.
- 5 Reconnect electrical power to the oven.

## Care and cleaning of the oven.

### Stainless Steel Surfaces *(on some models)*

**Do not use a steel wool pad; it will scratch the surface.**

To clean the stainless steel surface, use warm sudsy water or a stainless steel cleaner or polish. Always wipe the surface in the direction of the grain. Follow the cleaner instructions for cleaning the stainless steel surface.

To inquire about purchasing stainless steel appliance cleaner or polish, or to find the location of a dealer nearest you, please call our toll-free number:

**National Parts Center**  
**1.800.626.2002**  
**ge.com**

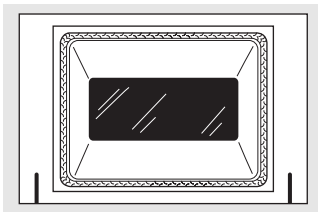

*Do not rub or clean the door gasket—it has an extremely low resistance to abrasion.*

*If you notice the gasket becoming worn, frayed or damaged in any way or if it has become displaced on the door, you should have it replaced.*

### Cleaning the Oven Door

#### To clean the inside of the door:

- Because the area inside the gasket is cleaned during the self-clean cycle, you do not need to clean this by hand.
- The area outside the gasket and the door liner can be cleaned with a soap-filled or plastic scouring pad, hot water and detergent. Rinse well with a vinegar and water solution.

#### To clean the outside of the door:

- Use soap and water to thoroughly clean the top, sides and front of the oven door. Rinse well. You may also use a glass cleaner to clean the glass on the outside of the door. Do not let water drip into the vent openings.

- If any stain on the door vent trim is persistent, use a soft abrasive cleaner and a sponge-scrubber for best results.
- Spillage of marinades, fruit juices, tomato sauces and basting materials containing acids may cause discoloration and should be wiped up immediately. When surface is cool, clean and rinse.
- Do not use oven cleaners, cleaning powders or harsh abrasives on the outside of the door.

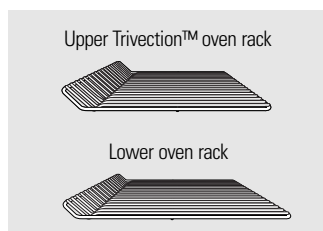

### Oven Racks

All oven racks may be cleaned by hand with an abrasive cleaner or steel wool. After cleaning, rinse the racks with clean water and dry with a clean cloth. Gray porcelain-coated oven racks may remain in the oven during the self-cleaning cycle without being damaged. The shiny, silver-colored oven racks may remain in the oven during the self-cleaning cycle, but they will lose their luster and become hard to slide.

It will be necessary to grease all oven rack side edges with a light coating of vegetable oil after cleaning them by hand or in the oven. This will help maintain the ease of sliding the racks in and out of the oven.

**NOTE:** On double wall ovens, the rack design is unique for the upper Trivection™ oven. Due to this, the upper oven racks and the lower oven racks are not interchangeable.

### Oven Heating Elements

Do not clean the broil element. Any soil will burn off when the element is heated.

To clean the area below the bake element, gently lift the element and clean with warm, soapy water.

### Control Panel

*If desired, the touch pads may be deactivated before cleaning.*

See the *Control lockout* information in the *Using the clock, timer and control lockout* section in this manual.

Clean up splatters with a damp cloth.

You may also use a glass cleaner.

Remove heavier soil with warm soapy water. Do not use abrasives of any kind.

*Reactivate the touch pads after cleaning.*

## Before you call for service...



### Troubleshooting Tips

Save time and money! Review the charts on the following pages first and you may not need to call for service.

Problem	Possible Causes	What To Do
<b>Food does not speed bake properly</b>	Oven controls improperly set.	• See <i>Using the Trivection™ Oven</i> section.
	Rack position is incorrect or the rack is not level.	• See <i>Using the Trivection™ Oven</i> section.
	Incorrect use of cookware and/or aluminum foil. Cookware of improper size being used.	• See <i>Using the Trivection™ Oven</i> section.
	Door not closed.	• Close door completely.
	Very delicate item.	• Use traditional bake.
	Food not to desired doneness.	• Cook times will vary due to recipe and pan variations. Check food when prompted and add additional time with <b>More Time</b> if needed.
	Sauce on food gets too brown.	• Apply sauce later in cooking cycle.
	Meat cooked too long.	• Remove from oven sooner and allow to stand. Meat temperature will continue to rise.
Food put in too early.	• Place food in the oven once the oven is preheated and the display shows <b>"PUT FOOD IN OVEN"</b> .	
<b>Temperature reading on meat thermometer seems inaccurate</b>	Don't use a meat thermometer in oven while speedcooking.	• Take the temperature of the meat <b>after</b> removing it from the oven.
<b>Food does not speed broil properly</b>	Oven controls improperly set.	• See <i>Using the Trivection™ Oven</i> section.
	Improper rack position being used.	• See the <i>Broiling Guide</i> .
	Cookware not suited to broiling.	• For best results, use a pan designed for broiling.
	Door not closed.	• Close door completely.
	Food overcooked.	• Remove from oven sooner and allow to stand. Food temperatures will continue to rise.
	Food undercooked.	• Speed broil for additional time using <b>MoreTime</b> .
	Meat is too done in center.	• Use traditional broil for very thin steaks or for foods where a rare to medium rare doneness is desired.
	Food put in too early.	• Place food in the oven once the oven is preheated and the display shows <b>"PUT FOOD IN OVEN"</b> .
<b>Cook time doesn't countdown while speedcooking</b>	Oven controls improperly set.	• See <i>Using the Trivection™ Oven</i> section.
	Door is not closed completely.	• Close door completely.
	<b>START</b> not selected.	• Press <b>START</b> once food is placed in the oven.



<b>Problem</b>	<b>Possible Causes</b>	<b>What To Do</b>
<b>Arcing between metal surfaces in oven while speedcooking or defrosting</b>	Improper spacing between metal surfaces and/or aluminum foil.	<ul style="list-style-type: none"> <li>• See <i>Using the Trivection™ Oven</i> section.</li> </ul>
<b>Display shows "Miswired detected"</b>	Wiring from house to oven is incorrect.	<ul style="list-style-type: none"> <li>• Contact installer or qualified electrician to check house wiring to oven.</li> </ul>
<b>Option not seen on the display screen</b>	Option may be listed on the next screen.	<ul style="list-style-type: none"> <li>• Select <b>MORE</b> to see additional items.</li> </ul>
<b>Hot air from oven</b>	When using the cooking features, hot air will exit the oven through the vent located above the door.	<ul style="list-style-type: none"> <li>• This is normal.</li> </ul>
<b>Food does not bake or roast properly in the oven</b>	Oven controls improperly set.	<ul style="list-style-type: none"> <li>• See the <i>Using traditional bake and roast</i> section.</li> </ul>
	Shelf position is incorrect or the shelf is not level.	<ul style="list-style-type: none"> <li>• See the <i>Using traditional bake and roast</i> section.</li> </ul>
	Incorrect cookware or cookware of improper size being used.	<ul style="list-style-type: none"> <li>• See the <i>Using traditional bake and roast</i> section.</li> </ul>
	Oven temperature needs adjustment.	<ul style="list-style-type: none"> <li>• See the <i>Adjust the oven temperature—Do it yourself!</i> section.</li> </ul>
<b>Food does not broil properly</b>	Oven controls improperly set.	<ul style="list-style-type: none"> <li>• Make sure you select <b>BROIL</b>.</li> </ul>
	Improper shelf position being used.	<ul style="list-style-type: none"> <li>• See the <i>Broiling Guide</i>.</li> </ul>
	Cookware not suited for broiling.	<ul style="list-style-type: none"> <li>• For best results, use a pan designed for broiling.</li> </ul>
	In some areas the power (voltage) may be low.	<ul style="list-style-type: none"> <li>• Preheat the broil element for 10 minutes.</li> <li>• Broil for the longest period of time recommended in the <i>Broiling Guide</i>.</li> </ul>
<b>Clock and timer do not work or display goes blank</b>	The clock is in the no clock mode.	<ul style="list-style-type: none"> <li>• See the <i>Settings</i> section for the oven clock.</li> </ul>
	Controls improperly set.	<ul style="list-style-type: none"> <li>• See the <i>Using the clock and lower oven timer</i> section.</li> </ul>
	A fuse in your home may be blown or the circuit breaker tripped.	<ul style="list-style-type: none"> <li>• Replace the fuse or reset the circuit breaker.</li> </ul>

## Before you call for service...



### Troubleshooting Tips

Problem	Possible Causes	What To Do
<b>Oven temperature too hot or too cold</b>	Oven temperature needs adjustment.	<ul style="list-style-type: none"> <li>See the <i>Adjust the oven temperature—Do it yourself!</i> section.</li> </ul>
<b>Oven will not work</b>	Oven controls improperly set. A fuse in your home may be blown or the circuit breaker tripped.	<ul style="list-style-type: none"> <li>See the <i>Using the oven</i> section.</li> <li>Replace the fuse or reset the circuit breaker.</li> </ul>
<b>Oven will not self-clean</b>	The oven temperature is too high to set a self-clean operation. Oven controls improperly set.	<ul style="list-style-type: none"> <li>Allow the oven to cool and reset the controls.</li> <li>See the <i>Using the self-cleaning oven</i> section.</li> </ul>
<b>“Crackling” or “popping” sound in the oven</b>	This is the sound of the metal heating and cooling during both the cooking and cleaning functions.	<ul style="list-style-type: none"> <li>This is normal.</li> </ul>
<b>Excessive smoking in the oven during a clean cycle</b>	Excessive soil.	<ul style="list-style-type: none"> <li>Press the <b>CLEAR/OFF</b> pad. Open the windows to rid the room of smoke. Wait until the <b>(LOCK)</b> light goes off. Wipe up the excess soil and reset the clean cycle.</li> </ul>
<b>Oven door will not open after a clean cycle</b>	Oven too hot.	<ul style="list-style-type: none"> <li>Allow the oven to cool below locking temperature.</li> </ul>
<b>Oven not clean after a clean cycle</b>	Oven controls improperly set. Oven was heavily soiled.	<ul style="list-style-type: none"> <li>See the <i>Using the self-cleaning oven</i> section.</li> <li>Clean up heavy spillovers before starting the clean cycle. Heavily soiled ovens may need to self-clean again or for a longer period of time.</li> </ul>
<b>(LOCK) light is on when you want to cook in the oven</b>	The oven door is locked because the temperature inside the oven has not dropped below the locking temperature.	<ul style="list-style-type: none"> <li>Press the <b>CLEAR/OFF</b> pad. Allow the oven to cool.</li> </ul>
<b>Display shows “ERR”</b>	A temperature was set outside the allowable range of 170°F–550°F.	<ul style="list-style-type: none"> <li>Set the temperature between 170°F–550°F.</li> </ul>

<b>Problem</b>	<b>Possible Causes</b>	<b>What To Do</b>
<b>Oven light does not work</b>	Light bulb is loose or defective. Pad operating light is broken.	<ul style="list-style-type: none"> <li>• Tighten or replace the bulb.</li> <li>• Call for service.</li> </ul>
<b>"F— and a number or letter" flash in the lower oven display</b>	You have a function error code. If the function code repeats.	<ul style="list-style-type: none"> <li>• Press the <b>CLEAR/OFF</b> pad. Allow the oven to cool for one hour. Put the oven back into operation.</li> <li>• Disconnect all power to the oven for at least 30 seconds and then reconnect power. If the function error code repeats, call for service.</li> </ul>
<b>Power outage, clock flashes</b>	Power outage or surge.	<ul style="list-style-type: none"> <li>• Reset the clock. If the oven was in use, you must reset it by pressing the <b>CLEAR/OFF</b> pad, setting the clock and resetting any cooking function.</li> </ul>
<b>Steam from the vent</b>	When using the convection or speedcook feature, it is normal to see steam coming out of the oven vent. As the number of shelves or amount of food being cooked increases, the amount of visible steam will increase.	<ul style="list-style-type: none"> <li>• This is normal.</li> </ul>
<b>"Burning" or "oily" odor emitting from oven vent</b>	This is normal in a new oven and will disappear in time.	<ul style="list-style-type: none"> <li>• To speed the process, set a self-clean cycle for a minimum of 3 hours. See the <i>Using the self-cleaning oven</i> section.</li> </ul>
<b>Strong odor in the oven</b>	An odor from the insulation around the inside of the oven is normal for the first few times the oven is used.	<ul style="list-style-type: none"> <li>• This is temporary.</li> </ul>
<b>Fan noise when using the oven</b>	A cooling fan or a convection fan (depending on the function you are using) may automatically turn on.	<ul style="list-style-type: none"> <li>• This is normal. The cooling fan will turn on to cool internal parts. It may run for up to 1-1/2 hours after the oven is turned off. The convection fan will cycle on and off until the function is over or the door is opened.</li> </ul>
<b>Oven door does not shut or racks do not fit properly on a double wall oven</b>	The lower oven rack is in the upper oven or the upper oven rack is in lower oven.	<ul style="list-style-type: none"> <li>• Place the correct rack in the correct oven. On double wall ovens, the rack design is unique for the upper Trivection™ oven. Due to this, the upper oven racks and the lower oven racks are not interchangeable.</li> </ul>

## Accessories.



### Looking For Something More?

You can find these accessories and many more at [ge.com](http://ge.com), or call **800.626.2002** (during normal business hours). Have your model number ready.

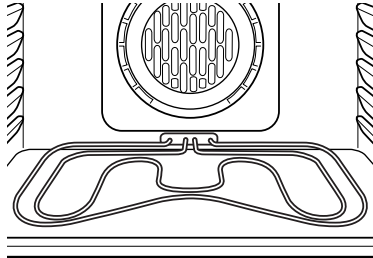

Oven Elements

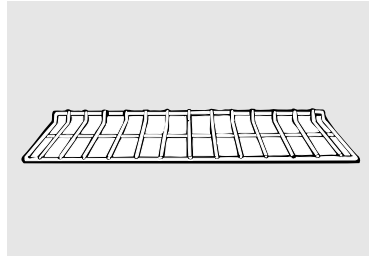

Oven Racks

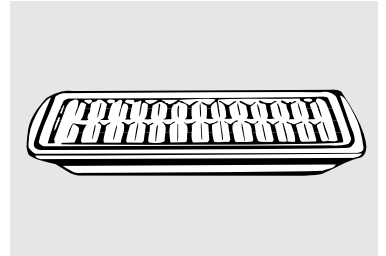

Broil Pan



Cleaner

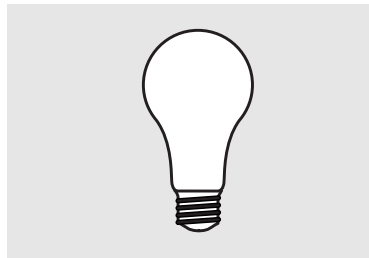

Light Bulbs

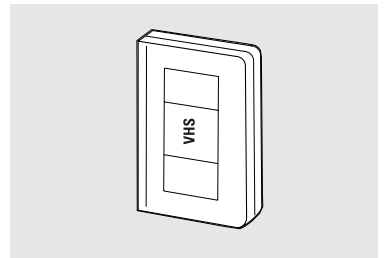

Trivection™ VHS Tape

Visit [ge.com](http://ge.com) for more information.

## GE Service Protection Plus™

GE, a name recognized worldwide for quality and dependability, offers you Service Protection Plus™—comprehensive protection on all your appliances—**No Matter What Brand!**

**Benefits Include:**

- Backed by GE
- All brands covered
- Unlimited service calls
- All parts and labor costs included
- No out-of-pocket expenses
- No hidden deductibles
- One 800 number to call

***We'll Cover Any Appliance.  
Anywhere. Anytime.\****

You will be completely satisfied with our service protection or you may request your money back on the remaining value of your contract. No questions asked. It's that simple.

Protect your refrigerator, dishwasher, washer and dryer, range, TV, VCR and much more—**any brand!** Plus there's no extra charge for emergency service and low monthly financing is available. Even icemaker coverage and food spoilage protection is offered. You can rest easy, knowing that all your valuable household products are protected against expensive repairs.

Place your confidence in GE and call us in the U.S. toll-free at **800.626.2224** for more information.

\*All brands covered, up to 20 years old, in the continental U.S.

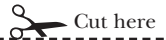

Please place in envelope and mail to:

***General Electric Company***  
**Warranty Registration Department**  
**P.O. Box 32150**  
**Louisville, KY 40232-2150**

# Consumer Product Ownership Registration

Dear Customer:

Thank you for purchasing our product and thank you for placing your confidence in us. We are proud to have you as a customer!

Follow these three steps to protect your new appliance investment:

# 1

Complete and mail your Consumer Product Ownership Registration today. Have the peace of mind of knowing we can contact you in the unlikely event of a safety modification.

# 2

After mailing the registration below, store this document in a safe place. It contains information you will need should you require service. Our service number is 800.GE.CARES (800.432.2737).

# 3

Read your Owner's Manual carefully. It will help you operate your new appliance properly.

Model Number

Serial Number

**Important: If you did not get a registration card with your product, detach and return the form below to ensure that your product is registered, or register online at [ge.com](http://ge.com).**



## Consumer Product Ownership Registration



Model Number

Serial Number

Mr.  Ms.  Mrs.  Miss

First Name

Last Name

Street Address

Apt. #

E-mail Address\*

City

State

Zip Code

Date Placed In Use  
Month

Day

Year

Phone Number --

\* Please provide your e-mail address to receive, via e-mail, discounts, special offers and other important communications from GE Appliances (GEA).

Check here if you do not want to receive communications from GEA's carefully selected partners.

**FAILURE TO COMPLETE AND RETURN THIS CARD DOES NOT DIMINISH YOUR WARRANTY RIGHTS.**

For more information about GEA's privacy and data usage policy, go to [ge.com](http://ge.com) and click on "Privacy Policy" or call 800.626.2224.



**GE Consumer & Industrial**  
Appliances  
General Electric Company  
Louisville, KY 40225  
[ge.com](http://ge.com)

# GE Self-Cleaning Oven with Trivection™ Warranty.



All warranty service provided by our Factory Service Centers, or an authorized Customer Care® technician. To schedule service, on-line, 24 hours a day, visit us at [ge.com](http://ge.com), or call 800.GE.CARES (800.432.2737). Please have serial number and model number available when calling for service.

Staple your receipt here.  
Proof of the original purchase date is needed to obtain service under the warranty.

## For The Period Of: **GE Will Replace:**

**One Year**  
From the date of the original purchase

**Any part** of the speedcook electric convection oven which fails due to a defect in materials or workmanship. During this **limited one-year warranty**, GE will also provide, **free of charge**, all labor and in-home service to replace the defective part.

## What GE Will Not Cover:

- Service trips to your home to teach you how to use the product.
- Improper installation, delivery or maintenance.
- Failure of the product if it is abused, misused, or used for other than the intended purpose or used commercially.
- Replacement of house fuses or resetting of circuit breakers.
- Damage to the product caused by accident, fire, floods or acts of God.
- Incidental or consequential damage caused by possible defects with this appliance.
- Damage caused after delivery.
- Product not accessible to provide required service.

**EXCLUSION OF IMPLIED WARRANTIES**—Your sole and exclusive remedy is product repair as provided in this Limited Warranty. Any implied warranties, including the implied warranties of merchantability or fitness for a particular purpose, are limited to one year or the shortest period allowed by law.

This warranty is extended to the original purchaser and any succeeding owner for products purchased for home use within the USA. If the product is located in an area where service by a GE Authorized Servicer is not available, you may be responsible for a trip charge or you may be required to bring the product to an Authorized GE Service location for service. In Alaska, the warranty excludes the cost of shipping or service calls to your home.

Some states do not allow the exclusion or limitation of incidental or consequential damages. This warranty gives you specific legal rights, and you may also have other rights which vary from state to state. To know what your legal rights are, consult your local or state consumer affairs office or your state's Attorney General.

**Warrantor: General Electric Company, Louisville, KY 40225**

Safety Instructions

Operating Instructions

Care and Cleaning

Troubleshooting Tips

Consumer Support

## Consumer Support.

---



### *GE Appliances Website*

**ge.com**

Have a question or need assistance with your appliance? Try the GE Appliances Website 24 hours a day, any day of the year! For greater convenience and faster service, you can now download Owner's Manuals, order parts or even schedule service on-line.



### *Schedule Service*

**ge.com**

Expert GE repair service is only one step away from your door. Get on-line and schedule your service at your convenience 24 hours any day of the year! Or call 800.GE.CARES (800.432.2737) during normal business hours.



### *Real Life Design Studio*

**ge.com**

GE supports the Universal Design concept—products, services and environments that can be used by people of all ages, sizes and capabilities. We recognize the need to design for a wide range of physical and mental abilities and impairments. For details of GE's Universal Design applications, including kitchen design ideas for people with disabilities, check out our Website today. For the hearing impaired, please call 800.TDD.GEAC (800.833.4322).



### *Extended Warranties*

**ge.com**

Purchase a GE extended warranty and learn about special discounts that are available while your warranty is still in effect. You can purchase it on-line anytime, or call 800.626.2224 during normal business hours. GE Consumer Home Services will still be there after your warranty expires.

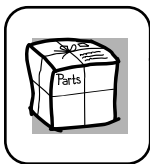

### *Parts and Accessories*

**ge.com**

Individuals qualified to service their own appliances can have parts or accessories sent directly to their homes (VISA, MasterCard and Discover cards are accepted). Order on-line today, 24 hours every day or by phone at 800.626.2002 during normal business hours.

**Instructions contained in this manual cover procedures to be performed by any user. Other servicing generally should be referred to qualified service personnel. Caution must be exercised, since improper servicing may cause unsafe operation.**



### *Contact Us*

**ge.com**

If you are not satisfied with the service you receive from GE, contact us on our Website with all the details including your phone number, or write to:

General Manager, Customer Relations  
GE Appliances, Appliance Park  
Louisville, KY 40225



### *Register Your Appliance*

**ge.com**

Register your new appliance on-line—at your convenience! Timely product registration will allow for enhanced communication and prompt service under the terms of your warranty, should the need arise. You may also mail in the pre-printed registration card included in the packing material.