



Radiant Self-Cleaning Convection Ranges

Safety Instructions2-5

Operating Instructions

Broiling14

Clock, Kitchen Timer and
Control Lock17

Convection Oven19-23

 Roasting Guide23

 Timed Features21, 22

Cookware7

Lower Oven13

Oven Controls10, 11

Probe16

Sabbath Feature30

Self-Cleaning26, 27

Slow Cook, Pizza
and Warming Features24-25

Special Features28-29

Surface Units6-9

Thermostat Adjustment—
Do It Yourself18

Timed Baking and
Roasting Features15

Upper Oven12

Care and Cleaning31-37

Troubleshooting Tips38-41

Accessories46

Consumer Support

Consumer Support Back Cover

Product Registration43, 44

Warranty47

Owner's Manual

PB970

PB975

Write the model and serial numbers here:

Model # _____

Serial # _____

You can find them on a label behind the storage drawer on the range frame.

IMPORTANT SAFETY INFORMATION. READ ALL INSTRUCTIONS BEFORE USING.

⚠ WARNING!

For your safety, the information in this manual must be followed to minimize the risk of fire, electric shock, or to prevent property damage, personal injury, or loss of life.



ANTI-TIP DEVICE



⚠ WARNING

- All ranges can tip.
- BURNS or other SERIOUS INJURIES can result.
- INSTALL and CHECK the ANTI-TIP bracket following the instructions supplied with the bracket.

To reduce the risk of tipping the range, the range must be secured by a properly installed anti-tip bracket. See installation instructions shipped with the bracket for complete details before attempting to install.

To check if the bracket is installed and engaged properly, remove the storage drawer or kick panel and look underneath the range to see that the leveling leg is engaged in the bracket. On models without a storage drawer or kick panel, carefully tip the range forward. The bracket should stop the range within 4 inches. If it does not, the bracket must be reinstalled. If the range is pulled from the wall for any reason, always repeat this procedure to verify the range is properly secured by the anti-tip bracket.

Never completely remove the leveling legs or the range will not be secured to the anti-tip device properly.

If you did not receive an anti-tip bracket with your purchase, call 1.800.626.8774 to receive one at no cost (in Canada, call 1.800.561.3344). For installation instructions of the bracket, visit GEAppliances.com (in Canada, GEAppliances.ca).



IMPORTANT SAFETY NOTICE

The California Safe Drinking Water and Toxic Enforcement Act requires the Governor of California to publish a list of substances known to the state to cause cancer, birth defects or other reproductive harm, and requires businesses to warn customers of potential exposure to such substances.

The fiberglass insulation in self-clean ovens gives off a very small amount of carbon monoxide during the cleaning cycle. Exposure can be minimized by venting with an open window or using a ventilation fan or hood.



SAFETY PRECAUTIONS

When using electrical appliances, basic safety precautions should be followed, including the following:

- Use this appliance only for its intended purpose as described in this Owner's Manual.
- Be sure your appliance is properly installed and grounded by a qualified installer in accordance with the provided installation instructions.
- Have the installer show you the location of the circuit breaker or fuse. Mark it for easy reference.
- Do not attempt to repair or replace any part of your range unless it is specifically recommended in this manual. All other servicing should be referred to a qualified technician.
- Before performing any service, disconnect the range power supply at the household distribution panel by removing the fuse or switching off the circuit breaker.
- Do not leave children alone—children should not be left alone or unattended in an area where an appliance is in use. They should never be allowed to sit or stand on any part of the appliance.
- Do not allow anyone to climb, stand or hang on the door or cooktop. They could damage the range and even tip it over, causing severe personal injury.



⚠ **WARNING!** SAFETY PRECAUTIONS

Do not operate the oven or cooktop controls if the glass is broken. Food splatter or cleaning solution may penetrate a broken control panel or cooktop and create a risk of electrical shock. Contact a qualified technician immediately should your glass control panel or cooktop become broken.

- Do not store flammable materials in an oven or near the cooktop.
 - **CAUTION:** Items of interest to children should not be stored in cabinets above a range or on the back of a range—children climbing on the range to reach items could be seriously injured.
 - Never wear loose-fitting or hanging garments while using the appliance. Be careful when reaching for items stored over the range. Flammable material could be ignited if brought in contact with hot surface units or heating elements and may cause severe burns.
 - Use only dry pot holders—moist or damp pot holders on hot surfaces may result in burns from steam. Do not let pot holders touch hot surface units or heating elements. Do not use a towel or other bulky cloth in place of pot holders.
 - Do not use water on grease fires. Never pick up a flaming pan. Turn the controls off. Smother a flaming pan on a surface unit by covering the pan completely with a well-fitting lid, cookie sheet or flat tray. Use a multi-purpose dry chemical or foam-type fire extinguisher.
- Flaming grease outside a pan can be put out by covering it with baking soda or, if available, by using a multi-purpose dry chemical or foam-type fire extinguisher.
- Flame in the oven can be smothered completely by closing the oven door and turning the oven off or by using a multi-purpose dry chemical or foam-type fire extinguisher.
- For your safety, never use your appliance for warming or heating the room.
 - Do not let cooking grease or other flammable materials accumulate in or near the range.
 - Do not touch the surface units, the heating elements or the interior surface of the oven. These surfaces may be hot enough to burn even though they are dark in color. During and after use, do not touch, or let clothing or other flammable materials contact the surface units, areas nearby the surface units or any interior area of the oven; allow sufficient time for cooling first.
- Potentially hot surfaces include the cooktop, areas facing the cooktop, oven vent opening, surfaces near the opening, crevices around the oven door.
- REMEMBER:** The inside surface of the oven may be hot when the door is opened.
- Do not store or use combustible materials, gasoline or other flammable vapors and liquids in the vicinity of this or any other appliance.
 - Keep the hood and grease filters clean to maintain good venting and to avoid grease fires.
 - Teach children not to play with the controls or any other part of the range.
 - Always keep dish towels, dish cloths, pot holders and other linens a safe distance from your range.
 - Always keep wooden and plastic utensils and canned food a safe distance from your range.
 - Always keep combustible wall coverings, curtains or drapes a safe distance from your range.



COOK MEAT AND POULTRY THOROUGHLY...

Cook meat and poultry thoroughly—meat to at least an INTERNAL temperature of 160°F and poultry to at least an INTERNAL temperature of 180°F. Cooking to these temperatures usually protects against foodborne illness.

IMPORTANT SAFETY INFORMATION. READ ALL INSTRUCTIONS BEFORE USING.



RADIANT SURFACE UNITS

Use proper pan size—select cookware having flat bottoms large enough to cover the surface unit heating element. The use of undersized cookware will expose a portion of the surface unit to direct contact and may result in ignition of clothing. Proper relationship of cookware to surface unit will also improve efficiency.

- Never leave the surface units unattended at high heat settings. Boilovers cause smoking and greasy spillovers that may catch on fire.
 - Only certain types of glass, glass/ceramic, earthenware or other glazed containers are suitable for cooktop service; others may break because of the sudden change in temperature.
 - To minimize the possibility of burns, ignition of flammable materials and spillage, the handle of a container should be turned toward the center of the range without extending over nearby surface units.
 - Always turn the surface units off before removing cookware.
 - When preparing flaming foods under the hood, turn the fan on.
 - Use care when touching the cooktop. The glass surface of the cooktop will retain heat after the controls have been turned off.
 - Keep an eye on foods being fried at high or medium high heat settings.
 - Foods for frying should be as dry as possible. Frost on frozen foods or moisture on fresh foods can cause hot fat to bubble up and over the sides of the pan.
 - Use little fat for effective shallow or deep fat frying. Filling the pan too full of fat can cause spillovers when food is added.
 - If a combination of oils or fats will be used in frying, stir together before heating, or as fats melt slowly.
 - Always heat fat slowly, and watch as it heats.
 - Use a deep fat thermometer whenever possible to prevent overheating fat beyond the smoking point.
 - Avoid scratching the glass cooktop. The cooktop can be scratched with items such as sharp instruments, rings or other jewelry, and rivets on clothing.
 - Large scratches or impacts to glass doors or cooktops can lead to broken or shattered glass.
 - Do not operate the radiant surface units if the glass is broken. Spillovers or cleaning solution may penetrate a broken cooktop and create a risk of electrical shock. Contact a qualified technician immediately should your glass cooktop become broken.
 - Never use the glass cooktop surface as a cutting board.
 - Do not place or store items that can melt or catch fire on the glass cooktop, even when it is not being used.
 - Be careful when placing spoons or other stirring utensils on glass cooktop surface when it is in use. They may become hot and could cause burns.
 - Clean the cooktop with caution. If a wet sponge or cloth is used to wipe spills on a hot surface unit, be careful to avoid steam burns. Some cleaners can produce noxious fumes if applied to a hot surface.
- NOTE:** We recommend that you avoid wiping any surface unit areas until they have cooled and the indicator light has gone off. **Sugar spills are the exception to this.** Please see the *Cleaning the glass cooktop* section.
- When the cooktop is cool, use only the CERAMA BRYTE® Ceramic Cooktop Cleaner and the CERAMA BRYTE Ceramic Cooktop Cleaning Pad to clean the cooktop.
 - To avoid possible damage to the cooking surface, do not apply cleaning cream to the glass surface when it is hot.
 - After cleaning, use a dry cloth or paper towel to remove all cleaning cream residue.
 - Read and follow all instructions and warnings on the cleaning cream labels.
 - Do not use plastic wrap to cover food. Plastic may melt onto the surface and be very difficult to remove.



⚠ WARNING!

OVEN

Stand away from the range when opening the oven door. Hot air or steam which escapes can cause burns to hands, face and/or eyes.

- Do not heat unopened food containers. Pressure could build up and the container could burst, causing an injury.
- Keep the oven vent unobstructed.
- Keep the oven free from grease buildup.
- Place the oven rack in the desired position while the oven is cool. If racks must be handled when hot, do not let pot holder contact the heating elements.
- When using cooking or roasting bags in the oven, follow the manufacturer's directions.
- Pulling out the rack to the stop-lock is a convenience in lifting heavy foods. It is also a precaution against burns from touching hot surfaces of the door or oven walls.
- Do not use the oven to dry newspapers. If overheated, they can catch on fire.
- Do not use the oven for a storage area. Items stored in an oven can ignite.
- Do not leave paper products, cooking utensils or food in the oven when not in use.
- Do not use aluminum foil to line oven bottoms, except as suggested in this manual. Improper installation of aluminum foil may result in a risk of electric shock or fire.



SELF-CLEANING UPPER OVEN AND LOWER OVEN

Do not use oven cleaners. No commercial oven cleaner or oven liner protective coating of any kind should be used in or around any part of the oven. Residue from oven cleaners will damage the inside of the oven when the self-clean cycle is used.

- Do not clean the door gasket. The door gasket is essential for a good seal. Care should be taken not to rub, damage or move the gasket.
- Before self-cleaning the oven, remove shiny, silver-colored oven racks (on some models) and all other cookware.
- Gray porcelain-coated oven racks (on some models) may be cleaned in the oven during the self-clean cycle.
- Be sure to wipe up excess spillage before starting the self-cleaning operation.
- If the self-cleaning mode malfunctions, turn the oven off and disconnect the power supply. Have it serviced by a qualified technician.
- Clean only parts listed in this Owner's Manual.



READ AND FOLLOW THIS SAFETY INFORMATION CAREFULLY.

SAVE THESE INSTRUCTIONS

About the radiant surface units.

NOTE: Throughout this manual, features and appearance may vary from your model.



Never cook directly on the glass.
Always use cookware.



Always place the pan in the center of
the surface unit you are cooking on.



Do not slide cookware across the
control or cooktop surface because it
can scratch the glass. The glass is
scratch-resistant, not scratchproof.

About the radiant surface units

The radiant cooktop features heating units beneath a smooth glass surface.

Cooktop temperatures increase with the number of surface units that are on. With 3 or 4 units turned on, surface temperatures are high. Always use caution when touching the cooktop.

An indicator light will come on when the surface unit is turned on.

The appropriate **HOT SURFACE** indicator light will glow when its corresponding radiant element is turned on and will remain on until the surface has cooled below 150°F.

NOTE:

Hot surface indicator light will:

- Come on when the surface unit is turned on.
- Stay on even after the unit is turned off.
- Glow brightly until the unit has cooled below 150°F.

NOTE: A slight odor is normal when a new cooktop is used for the first time. It is caused by the heating of new parts and insulating materials and will disappear in a short time.

NOTE: On models with light-colored glass cooktops, it is normal for the cooking zones to change color when hot or cooling down. This is temporary and will disappear as the glass cools to room temperature.

It is safe to place hot cookware from the oven or surface on the glass cooktop when the surface is cool.

Even after the surface units are turned off, the glass cooktop retains enough heat to continue cooking. To avoid overcooking, remove pans from the surface units when the food is cooked. Avoid placing anything on the surface unit until it has cooled completely.

- Water stains (mineral deposits) are removable using the cleaning cream or full strength white vinegar.
- Use of window cleaner may leave an iridescent film on the cooktop. The cleaning cream will remove this discoloration.
- Don't store heavy items above the cooktop. If they drop onto the cooktop, they can cause damage.
- Do not use the surface as a cutting board.

Temperature Limiter

Every radiant surface unit has a temperature limiter.

The temperature limiter protects the glass cooktop from getting too hot.

The temperature limiter may cycle the units off for a time if:

- The pan boils dry.
- The pan bottom is not flat.
- The pan is off center.
- There is no pan on the unit.

The following information will help you choose cookware which will give good performance on glass cooktops.

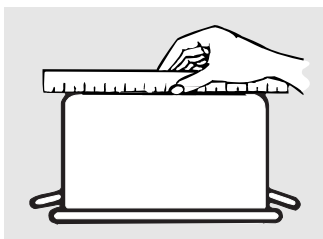

Check pans for flat bottoms by using a straight edge.



Pans with rounded, curved, ridged or warped bottoms are not recommended.

Stainless Steel:

recommended

Aluminum:

heavy weight recommended

Good conductivity. Aluminum residues sometimes appear as scratches on the cooktop, but can be removed if cleaned immediately. Because of its low melting point, thin weight aluminum should not be used.

Copper Bottom:

recommended

Copper may leave residues which can appear as scratches. The residues can be removed, as long as the cooktop is cleaned immediately. However, do not let these pots boil dry. Overheated metal can bond to glass cooktops. An overheated copper bottom pot will leave a residue that will permanently stain the cooktop if not removed immediately.

Porcelain Enamel Covered Cast Iron:

recommended

As long as the cookware is covered completely with porcelain enamel, this cookware is recommended. Caution is recommended for cast iron cookware that is not completely covered with smooth porcelain enamel, as it may scratch the glass ceramic cooktop.

Glass-ceramic:

usable, but not recommended

Poor performance. May scratch the surface.

Stoneware:

usable, but not recommended

Poor performance. May scratch the surface.

Home Canning Tips

Be sure the canner is centered over the surface unit.

Make sure the canner is flat on the bottom.

To prevent burns from steam or heat, use caution when canning.

Use recipes and procedures from reputable sources. These are available from manufacturers such as Ball® and Kerr® and the Department of Agriculture Extension Service.

Flat-bottomed canners are recommended. Use of water bath canners with rippled bottoms may extend the time required to bring the water to a boil.

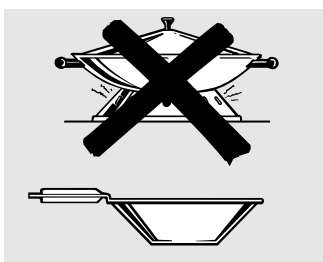

Use only flat-bottomed woks.

Wok Cooking

We recommend that you use only a flat-bottomed wok. They are available at your local retail store.

Do not use woks that have support rings.

Do not use round-bottom woks. You could be seriously burned if the wok tipped over.

Using the surface units.

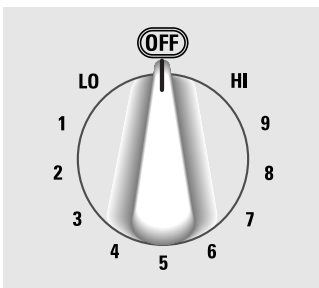

Be sure you turn the control knob to OFF when you finish cooking.

How to Set

Push the knob in and turn in either direction to the setting you want.

At both **OFF** and **HI** the control **clicks** into position. You may hear slight **clicking** sounds during cooking, indicating the control is keeping the power level you set.

A **HOT SURFACE** indicator light, on the cooktop, will glow when any radiant element is turned on. It will remain on until the surface is cooled to approximately 150°F.

Hot surface indicator light will:

- come on when the unit is hot to the touch.
- stay on even after the unit is turned off.
- glow until the unit is cooled to approximately 150°F.

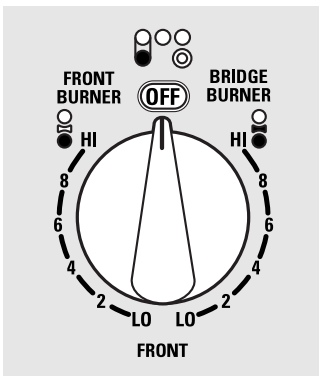

Using the Bridge Burner (on some models)

To use the bridge burner, turn the left front control knob to the **BRIDGE BURNER** settings.

For full bridge surface unit operation, also turn on the left rear surface unit.

To use only the front surface unit, turn the control knob to the **FRONT BURNER** settings.

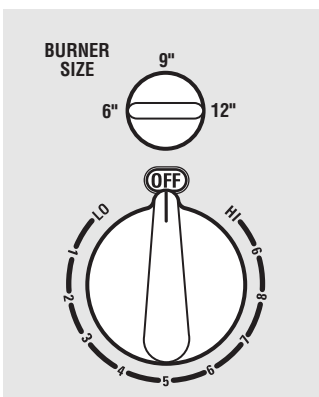
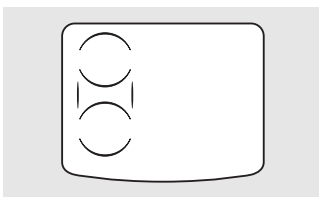
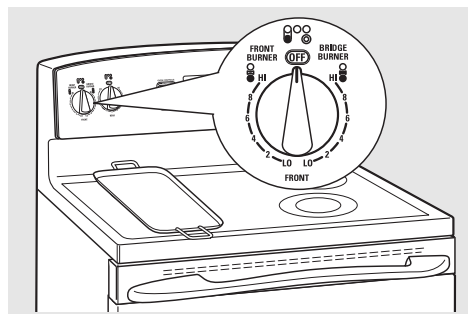

Tri-Ring Surface Element (on some models)

The front right surface element offers 3 cooking areas to match the size of the cookware you are using.

To use the largest cooking area, push in and turn the **SELECTOR** knob to **12"**. Push and turn the control knob to the desired setting.

To use the medium cooking area, press and turn the **SELECTOR** knob to **9"**. Push down and turn the control knob to the desired setting.

To use the smallest cooking area, turn the **SELECTOR** knob to **6"**. Push and turn the control knob to the desired setting. This will activate only the smallest inside heating area.

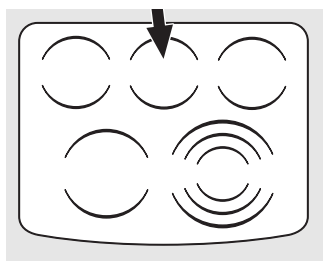
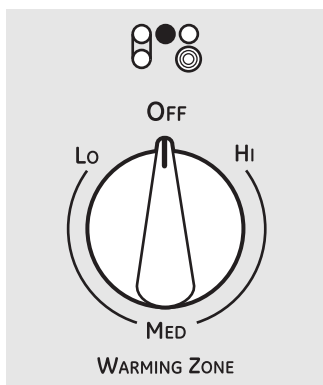

Using the Warming Zone (on some models)

The **WARMING ZONE** is located in the back center of the glass surface. Always start with hot food. Do not use to heat cold food. Placing uncooked or cold food on the **WARMING ZONE** could result in foodborne illness.

To use the **WARMING ZONE**:

Turn the **WARMING ZONE** knob to the setting you want, from **HI** to **LO**.

To turn off the **WARMING ZONE**:

Turn the **WARMING ZONE** knob to **OFF**.

For best results, all foods on the **WARMING ZONE** should be covered with a lid or aluminum foil.

Always use pot holders or oven mitts when removing food from the **WARMING ZONE**, as cookware will be hot.

A **HOT** surface indicator light will glow when the glass surface is hot and will remain on until the surface is cool enough to touch. Lower settings may not heat the glass surface enough to cause the **HOT** surface indicator light to come on.

NOTE: The **WARMING ZONE** will not glow red like the cooking elements.

Food Type	Control Setting
Sauces	LO
Soups (cream)	MED
Stews	MED
Vegetables	MED
Hot Beverages	HI
Soups (other than cream)	HI
Breads/Pastries	LO

The chart above shows initial suggested settings only. The temperature, type and amount of food, type of pan and the time held will affect the quality of the food.

CAUTION: Do not leave food on the **WARMING ZONE** for more than 2 hours.

- Do not use plastic wrap to cover food. Plastic may melt onto the surface and be very difficult to clean.
- Use only cookware recommended for top-of-range cooking.

Using the oven controls.

NOTE: Throughout this manual, features and appearance may vary from your model.

Features and appearance may vary.

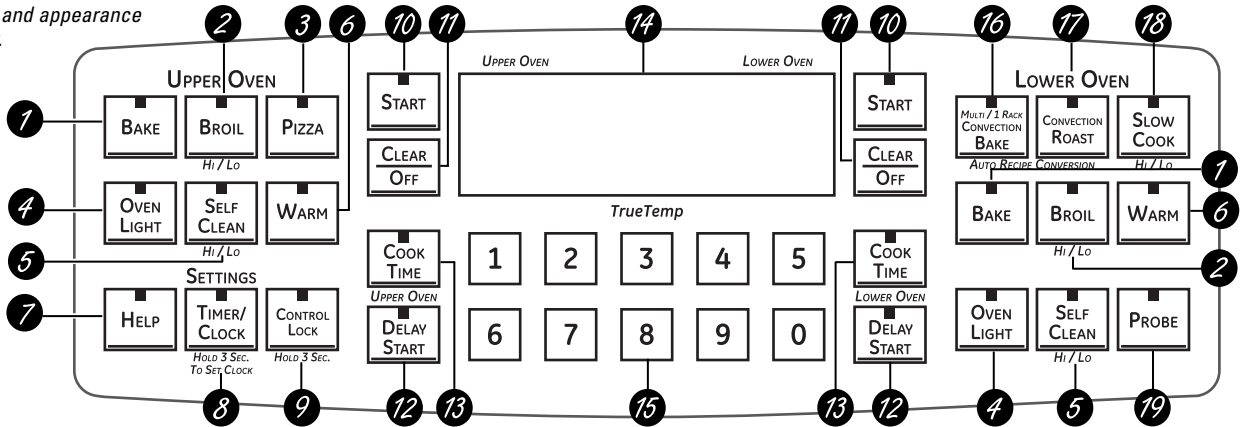

Oven Control, Clock and Timer Features and Settings

- 1** **BAKE Pad**
Touch to select the bake function.
- 2** **BROIL HI/LO Pad**
Touch to select the broil function.
- 3** **PIZZA Pad**
Touch to select the Pizza function.
- 4** **OVEN LIGHT Pad**
Touch to turn the oven light on or off.
- 5** **SELF CLEAN HI/LO Pad**
Touch to select self-cleaning function. See the *Using the self-cleaning upper and lower ovens* section.
- 6** **WARM Pad**
Touch to keep cooked foods warm. See the *How to Set the Lower and Upper Ovens for Warming* section.
- 7** **HELP Pad**
Touch to get help on a specific function or to change options.
- 8** **TIMER/CLOCK Pad**
Touch to select the timer feature or to set the clock. Touch once for timer. Hold for 3 seconds to set clock.
- 9** **CONTROL LOCK Pad**
Hold this pad for 3 seconds to lock/unlock the range touch pad controls and cooktop controls.
- 10** **START Pad**
Must be touched to start any cooking or cleaning function.
- 11** **CLEAR/OFF Pad**
Touch to cancel **ALL** oven operations except the clock and timer.
- 12** **DELAY START Pad**
Use along with **COOK TIME** or
- 13** **COOK TIME Pad**
Touch this pad and then touch the number pads to set the amount of time you want your food to cook. The oven will shut off when the cooking time has run out.
- 14** **Display**
Shows the time of day, oven temperature, whether the oven is in the bake, broil or self-cleaning mode and the times set for the timer or automatic oven operations.
- 15** **Number Pads**
Use to set any function requiring numbers such as the time of day on the clock, the timer, the oven temperature, the internal food temperature, the start time and length of operation for timed baking and self-cleaning.
- 16** **CONVECTION BAKE Pad**
Touch to select baking with the convection function.
- 17** **CONVECTION ROAST Pad**
Touch to select roasting with the convection function.
- 18** **SLOW COOK Pad**
Touch to select the Slow Cook function.
- 19** **PROBE Pad**
Touch when using the probe to cook food.

SELF CLEAN HI/LO pads to set the oven to start and stop automatically at a time you set.

If your oven was set for a timed oven operation and a power outage occurred, the clock and all programmed functions must be reset.

The time of day will flash in the display when there has been a power outage.

NOTE: When setting times, you are setting hours and minutes only. The lowest time you can set is one minute.

Features and appearance may vary.

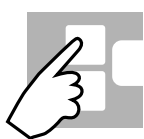
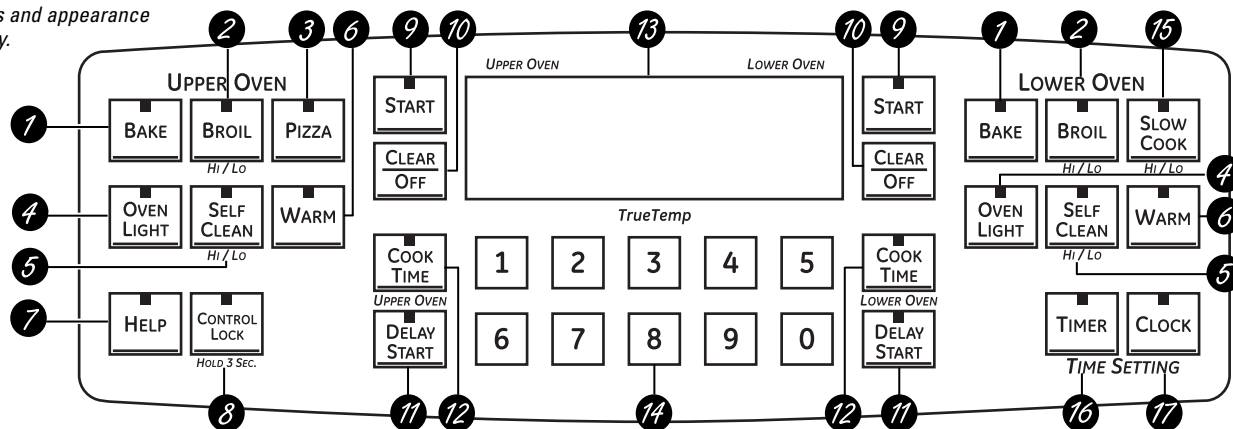

Oven Control, Clock and Timer Features and Settings

- 1** **BAKE Pad**
Touch to select the bake function.
- 2** **BROIL HI/LO Pad**
Touch to select the broil function.
- 3** **PIZZA Pad**
Touch to select the Pizza function.
- 4** **OVEN LIGHT Pad**
Touch to turn the oven light on or off.
- 5** **SELF CLEAN HI/LO Pad**
Touch to select self-cleaning function. See the *Using the self-cleaning upper and lower ovens* section.
- 6** **WARM Pad**
Touch to keep cooked foods warm. See the *How to Set the Lower and Upper Ovens for Warming* section.
- 7** **HELP Pad**
Touch to get help on a specific function or to change options.
- 8** **CONTROL LOCK Pad**
Hold this pad for 3 seconds to lock/unlock the range touch pad controls and cooktop controls.
- 9** **START Pad**
Must be touched to start any cooking or cleaning function.
- 10** **CLEAR/OFF Pad**
Touch to cancel **ALL** oven operations except the clock and timer.
- 11** **DELAY START Pad**
Use along with **COOK TIME** or **SELF CLEAN HI/LO** pads to set the oven to start and stop automatically at a time you set.
- 12** **COOK TIME Pad**
Touch and then touch the number pads to set the amount of time you want your food to cook. The oven will shut off when the cooking time has run out.
- 13** **Display**
Shows the time of day, oven temperature, whether the oven is in the bake, broil or self-cleaning mode and the times set for the timer or automatic oven operations.
If your oven was set for a timed oven operation and a power outage occurred, the clock and all programmed functions must be reset.
The time of day will flash in the display when there has been a power outage.
- 14** **Number Pads**
Use to set any function requiring numbers such as the time of day on the clock, the timer, the oven temperature, the internal food temperature, the start time and length of operation for timed baking and self-cleaning.
- 15** **SLOW COOK Pad**
Touch to select the Slow Cook function.
- 16** **TIMER Pad**
Touch to select the timer feature.
- 17** **CLOCK Pad**
Touch before setting the clock.

NOTE: When setting times, you are setting hours and minutes only. The lowest time you can set is one minute.

Using the upper oven.

To avoid possible burns, place the racks in the desired position before you turn the oven on.

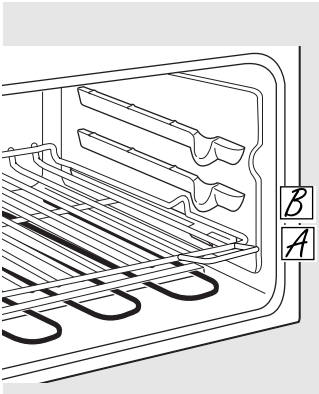

The oven has 2 rack positions.

Before you begin...

The upper rack, with two front handles, has stops, so that when placed correctly on the supports, it will stop before coming completely out, and will not tilt.

NOTE: Use the rack with the two front handles in the upper oven.

When placing and removing cookware, pull the rack out until it stops.

To remove a rack, pull it toward you, tilt the front end up and pull it out.

To replace, place the end of the rack (stop-locks) on the support, tilt up the front and push the rack in.

CAUTION: When you are using a rack in the lowest position (A), you will need to use caution when pulling the rack out. (Be sure to use the handles on the rack.) We recommend that you pull the rack out several inches and then, using two pot holders, pull the rack out by holding the sides of it. The rack is low and you could be burned if you place your hand in the middle of the rack and pull all the way out. Be very careful not to burn your hand on the door when using the rack in the lowest position (A).

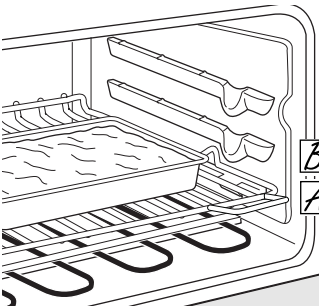

How to Set the Upper Oven for Baking

- 1 Touch the **BAKE** pad.
- 2 Touch the number pads to set the desired temperature.
- 3 Touch the **START** pad.
- 4 Check food for doneness at minimum time on recipe. Cook longer if necessary.
- 5 Touch the **CLEAR/OFF** pad when cooking is complete.

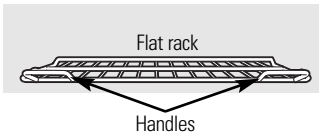

Use the rack with the two front handles in the upper oven.

Preheating and Pan Placement

Preheat the oven if the recipe calls for it. Preheating is necessary for good results when baking cakes, cookies, pastry and breads.

To preheat, set the oven at the correct temperature. The control will beep when the oven is preheated and the display will show your set temperature. This will take approximately 4–6 minutes.

Baking results will be better if baking pans are centered in the oven as much as possible. If baking with more than one pan, place the pans so each has at least 1" to 1½" of air space around it.

Type of Food	Rack Position
Frozen pies (on cookie sheet)	A
Biscuits, muffins, brownies, cookies, cupcakes, layer cakes, pies	A
Casseroles	A
Pizza – Fresh supplied w/ baking tray	B
Pizza placed directly on rack	B
Pizza on metal tray	A

NOTE: To bake angel food cake and Bundt cake, it is recommended that you only use the lower oven.

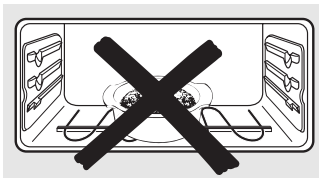

Do not place foods directly on the oven floor.

Using the lower oven.

ge.com

To avoid possible burns, place the racks in the desired position before you turn the oven on.

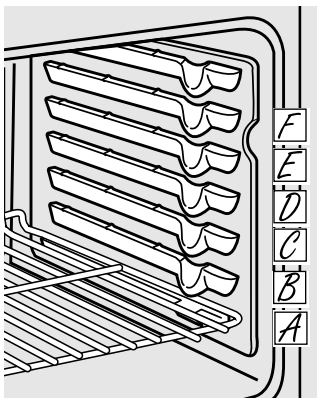

The oven has 6 rack positions.

Before you begin...

The racks have stops, so that when placed correctly on the supports, they will stop before coming completely out, and will not tilt.

When placing and removing cookware, pull the rack out until it stops.

On some models, the bake heating element is under the oven floor. Do not place foods on the oven bottom for cooking.

To remove a rack, pull it toward you, tilt the front end up and pull it out.

To replace, place the end of the rack (stop-locks) on the support, tilt up the front and push the rack in.

CAUTION: When you are using a rack in the lowest position (A), you will need to use caution when pulling the rack out. We recommend that you pull the rack out several inches and then, using two pot holders, pull the rack out by holding the sides of it. The rack is low and you could be burned if you place your hand in the middle of the rack and pull all the way out. Be very careful not to burn your hand on the door when using the rack in the lowest position (A).

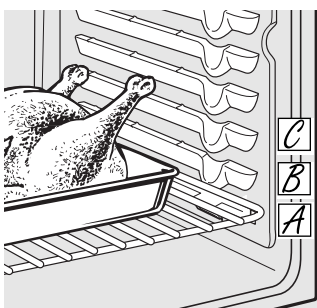

How to Set the Lower Oven for Baking or Roasting

- 1 Touch the **BAKE** pad.
- 2 Touch the number pads to set the desired temperature.
- 3 Touch the **START** pad.
- 4 Check food for doneness at minimum time on recipe. Cook longer if necessary.
- 5 Touch the **CLEAR/OFF** pad when cooking is complete.

NOTE: On some models, you will hear the convection fan while the oven is preheating. The fan will stop after the oven is preheated and the display shows your set temperature. This is normal.

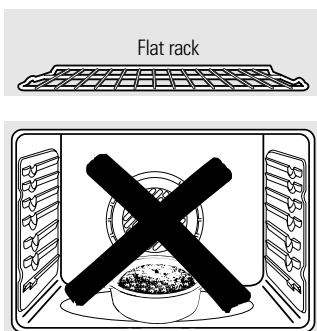

Do not place foods or baking stone directly on the oven floor.

Preheating and Pan Placement

Preheat the oven if the recipe calls for it. Preheating is necessary for good results when baking cakes, cookies, pastry and breads.

To preheat, set the oven at the correct temperature. The control will beep when the oven is preheated and the display will show your set temperature. This will take approximately 10–15 minutes.

Baking results will be better if baking pans are centered in the oven as much as possible. If baking with more than one pan, place the pans so each has at least 1" to 1½" of air space around it.

Type of Food	Rack Position
Frozen pies (on cookie sheet)	C
Angel food cake	A
Bundt or pound cakes	C
Biscuits, muffins, brownies, cookies, cupcakes, layer cakes, pies	C
Casseroles	C
Turkey	A

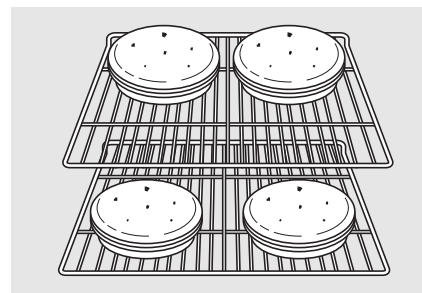

If baking four cake layers at the same time, place two layers on rack B and two layers on rack D. Stagger pans on the rack so one is not directly above the other.

Safety Instructions

Operating Instructions

Care and Cleaning

Troubleshooting Tips

Consumer Support

Using the upper and lower ovens.

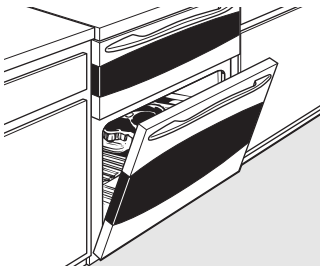

If your range is connected to 208 volts, rare steaks may be broiled by preheating the broiler and positioning the oven rack one position higher.

How to Set the Upper and Lower Ovens for Broiling

Leave the door open to the broil stop position. The door stays open by itself, yet the proper temperature is maintained in the oven.

- 1 Place the meat or fish on a broiler grid in a broiler pan.
- 2 Follow suggested rack positions in the *Broiling Guide*.
- 3 Touch the **BROIL HI/LO** pad once for **HI Broil**.

To change to **LO Broil**, touch the **BROIL HI/LO** pad again.

Use **LO Broil** to cook foods such as poultry or thick cuts of meat thoroughly without over-browning them.

- 4 Touch the **START** pad.
- 5 When broiling is finished, touch the **CLEAR/OFF** pad.

NOTE: Broil and self-clean settings will not work if the temperature probe is plugged in.

Broiling Guide

Food			Upper Cavity			Lower Cavity			Comments
			Rack Position	Time Side 1	Time Side 2	Rack Position	Time Side 1	Time Side 2	
Ground Beef	Well Done	8 3/4" patties	A	11	9-10	F	10	6-7	Space evenly. Up to 8 patties takes about the same time.
Beef Steaks	Rare†	1" thick 1 lb.	A	9	4-6	F	7	4-5	Steaks less than 1" thick cook through before browning. Pan frying is recommended. Slash fat.
	Medium	1" thick 1 lb.	A	11	5-7	F	9	5-7	
	Well Done	1" thick 1 lb.	A	13	7-9	F	11	7-9	
	Rare†	1½" thick 2 lbs.	A	15	6-8	F	14	5-7	
	Medium	1½" thick 2 lbs.	A	17	7-9	F	16	6-8	
Well Done	1½" thick 2 lbs.	A	20	8-10	F	19	8-10		
Chicken	Well Done	1 whole 3-4 lbs split lengthwise	A	20	8-13	D	25	10-15	REDUCE TIME ABOUT 2-3 MINUTES PER SIDE FOR CUT-UP CHICKEN. Brush each side with melted butter. Broil skin-side-down first.
Lobster Tails		2-4 10 to 12 oz. each	A	19-21	Do not turn.	D	18-20	Do not turn.	Cut through back of shell. Spread open. Brush with melted butter before broiling and after half of broiling time, if desired.
Fish Fillets	Well Done	1/4 to 1/2" thick	A	5	4-5	F	5	4-5	Handle and turn very carefully. Brush with lemon butter before and during cooking, if desired.
Ham Slices (precooked)		1" thick	A	6	6	E	6	6	Increase time 2-5 minutes per side for 1½" thick ham.
Pork Chops	Well Done	2 (1½" thick)	A	10	6-7	F	9	5-6	Slash fat.
	Well Done	2 (1" thick)	A	14	7-8	F	13	7-9	
Lamb Chops	Medium	2 (1" thick)	A	9	6-7	F	10	8-9	Slash fat.
	Well Done	2 (1" thick)	A	11	7-8	F	12	9-10	
	Medium	2 (1½" thick)	A	13	9-10	F	14	11-12	
	Well Done	2 (1½" thick)	A	16	10-12	F	17	12-14	

The size, weight, thickness, starting temperature and your preference of doneness will affect broiling times. This guide is based on meats at refrigerator temperature.

† The U.S. Department of Agriculture says "Rare beef is popular, but you should know that cooking it to only 140°F means some food poisoning organisms may survive." (Source: *Safe Food Book. Your Kitchen Guide.* USDA Rev. June 1985.)

Using the timed baking and roasting features. (on some models)

ge.com

NOTE: Foods that spoil easily—such as milk, eggs, fish, stuffings, poultry and pork—should not be allowed to sit for more than 1 hour before or after cooking. Room temperature promotes the growth of harmful bacteria. Be sure that the oven light is off because heat from the bulb will speed harmful bacteria growth.

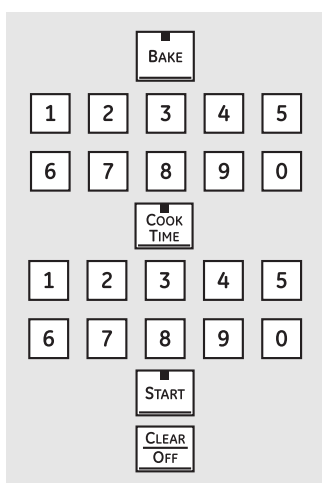

How to Set an Immediate Start and Automatic Stop

The oven will turn on immediately and cook for a selected length of time. At the end of the cooking time the oven will turn off automatically.

- 1 Touch the **BAKE** pad.
- 2 Touch the number pads to set the desired oven temperature.
- 3 Touch the **COOK TIME** pad.

NOTE: If your recipe requires preheating, you may need to add additional time to the length of the cooking time.

- 4 Touch the number pads to set the desired length of cooking time. The minimum cooking time you can set is 1 minute.

The oven temperature that you set and the cooking time that you entered will be in the display.

- 5 Touch the **START** pad.

NOTE: An attention tone will sound if you are using timed baking and do not touch the **START** pad.

The oven will turn **ON**, and the display will show the cooking time countdown and the changing temperature starting at 100°F. (The temperature display will start to change once the oven temperature reaches 100°F.) When the oven reaches the temperature you set, 3 beeps will sound.

The oven will continue to cook for the set amount of time, then turn off automatically, unless the WARM feature was set. See the *How to Set the Oven for Warming* section.

- 6 Touch the **CLEAR/OFF** pad to clear the display if necessary. Remove the food from the oven. Remember, even though the oven turns off automatically, food left in the oven will continue cooking after the oven turns off.

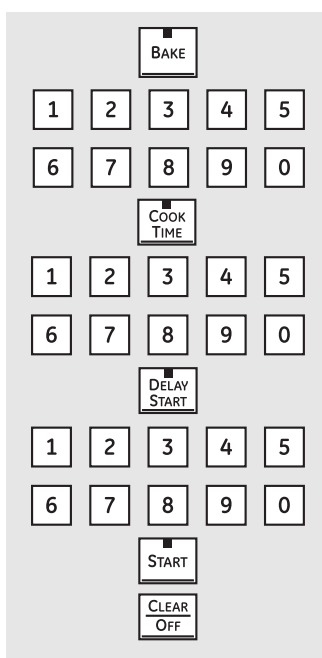

How to Set a Delayed Start and Automatic Stop

The oven will turn on at the time of day you set, cook for a specific length of time and then turn off automatically.

Make sure the clock shows the correct time of day.

- 1 Touch the **BAKE** pad.
- 2 Touch the number pads to set the desired oven temperature.
- 3 Touch the **COOK TIME** pad.

NOTE: If your recipe requires preheating, you may need to add additional time to the length of the cooking time.

- 4 Touch the number pads to set the desired length of cooking time. The minimum cooking time you can set is 1 minute.

The oven temperature that you set and the cooking time that you entered will be in the display.

- 5 Touch the **DELAY START** pad.
- 6 Touch the number pads to set the time of day you want the oven to turn on and start cooking.
- 7 Touch the **START** pad.

NOTE: An attention tone will sound if you are using timed baking and do not touch the **START** pad.

NOTE: If you would like to check the times you have set, touch the **DELAY START** pad to check the start time you have set or touch the **COOK TIME** pad to check the length of cooking time you have set.

When the oven turns **ON** at the time of day you set, the display will show the cooking time countdown and the changing temperature starting at 100°F. (The temperature display will start to change once the oven temperature reaches 100°F.) When the oven reaches the temperature you set, beeps will sound.

The oven will continue to cook for the set amount of time, then turn off automatically, unless the WARM feature was set. See the *How to Set the Oven for Warming* section.

- 8 Touch the **CLEAR/OFF** pad to clear the display if necessary. Remove the food from the oven. Remember, even though the oven turns off automatically, food left in the oven will continue cooking after the oven turns off.

Using the probe on the lower convection oven. (on some models)

For many foods, especially roasts and poultry, internal food temperature is the best test for doneness. The temperature probe takes the guesswork out of roasting by cooking foods to the exact doneness you want.

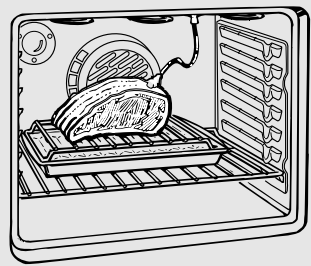

The temperature probe has a skewer-like probe at one end and a plug at the other end that goes into the outlet in the oven.

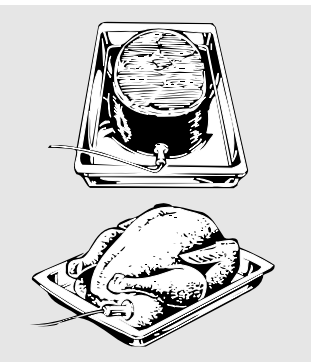

Use of probes other than the one provided with this product may result in damage to the probe or oven control.

Use the handles of the probe and plug when inserting and removing them from the food and outlet.

- To avoid damaging your probe, do not use tongs to pull on the cable when removing it.
- To avoid breaking the probe, make sure food is completely defrosted before inserting.

After preparing the meat and placing it on a trivet or a broiler pan grid, follow these directions for proper probe placement.

Insert the probe completely into the meat. It should not touch bone, fat or gristle.

NOTE: Failure to fully insert the probe into the meat may result in poor cooking performance because the probe will sense the oven air vs. the food temperature.

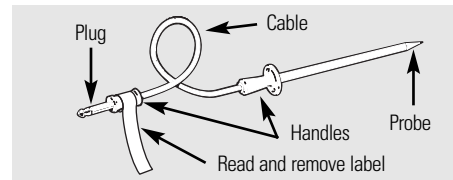

- Never leave your probe inside the oven during a self-cleaning or broil cycle.
- Do not store the probe in the oven.

CAUTION: To prevent possible burns, do not unplug the probe from the oven outlet until the oven has cooled.

For roasts with no bone, insert the probe into the meatiest part of the roast. For bone-in ham or lamb, insert the probe into the center of the lowest large muscle.

Insert the probe into the center of dishes such as meat loaf or casseroles.

Insert the probe into the meatiest part of the inner thigh from below and parallel to the leg of a whole turkey.

NOTE: Self-clean and Broil settings will not work if the temperature probe is plugged in.

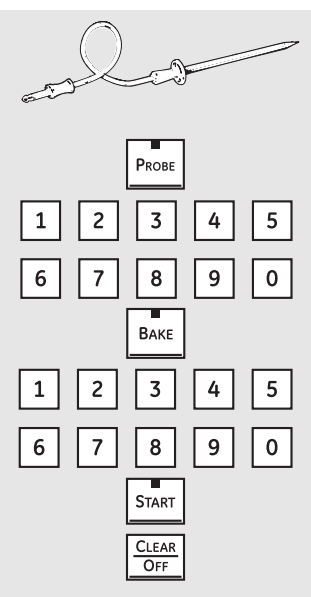

How to Set the Lower Oven For Baking/Roasting When Using the Probe (on some models)

- 1 Insert the probe fully into the food.
- 2 Plug the probe into the outlet in the oven. Make sure it's pushed all the way in. Close the oven door. Make sure the probe cable is not touching the broil element.
- 3 Touch the **PROBE** pad. Display will show "Set Probe Temperature."
- 4 Touch the number pads to set the desired internal food or meat temperature. The maximum internal temperature for the food that you can set is 200°F.
- 5 Touch the **BAKE** pad.
- 6 Touch the number pads to set the desired oven temperature.
- 7 Touch the **START** pad.

After the internal temperature of the food reaches 100°F, the changing internal temperature will be shown in the display.

- 8 When the internal temperature of the food reaches the number you have set, the probe and the oven turn off and the oven control signals. To stop the signal, touch the **CLEAR/OFF** pad. Use hot pads to remove the probe from the food. Do not use tongs to pull on it—they might damage it.

- If the probe is removed from the oven while probe cooking, the oven will not automatically turn off.

To change the oven temperature during the Bake/Roast cycle, touch the **BAKE** pad and then the number pads to set the new temperature.

- You can use the Kitchen Timer even though you cannot use timed oven operations while using the probe.

Using the clock, kitchen timer and control lock.

ge.com

Safety Instructions

Operating Instructions

Care and Cleaning

Troubleshooting Tips

Consumer Support



(on some models)



(on some models)

Make sure the clock is set to the correct time of day.

To Set the Clock

The clock must be set to the correct time of day for the automatic oven timing functions to work properly. The time of day cannot be changed during a timed baking or self-cleaning cycle.

- 1 **On some models**, touch the **TIMER/CLOCK** pad and hold for 3 seconds. **On other models**, touch the **CLOCK** pad.
- 2 Touch the number pads.
- 3 Touch the **START** pad.



(on some models)



(on some models)

The Kitchen Timer is in hours and minutes.

The Kitchen Timer does not control oven operations. The maximum setting on the Kitchen Timer is 9 hours and 59 minutes.

To Set the Kitchen Timer

- 1 Touch the **TIMER/CLOCK** or **TIMER** pad (depending on model).
- 2 Touch the number pads until the amount of time you want shows in the display. For example, to set 2 hours and 45 minutes, touch **2**, **4** and **5** in that order. If you make a mistake touch the **TIMER/CLOCK** or **TIMER** pad (depending on model) and begin again.
- 3 Touch the **START** pad.

After touching the **START** pad, **SET** disappears; this tells you the time is counting down, although the display does not change until one minute has passed. Seconds will not be shown in the display until the last minute is counting down.

- 4 When the Kitchen Timer reaches **:00**, the control will beep 3 times followed by one beep every 6 seconds until the **TIMER/CLOCK** or **TIMER** pad (depending on model) is touched.

The 6-second tone can be canceled by following the steps in the Special features of your oven control section under Tones at the End of a Timed Cycle.

To Reset the Kitchen Timer

If the display is still showing the time remaining, you may change it by touching the **TIMER/CLOCK** or **TIMER** pad (depending on model), then touch the number pads until the time you want appears in the display.

If the remaining time is not in the display (clock, delay start or cooking time are in the display), recall the remaining time by touching the **TIMER/CLOCK** or **TIMER** pad (depending on model) and then touching the number pads to enter the new time you want.

To Cancel the Kitchen Timer

Touch the **TIMER/CLOCK** or **TIMER** pad (depending on model) twice.



Control Lock (on some models)

Your control will allow you to lock out the touch pads and the cooktop so they cannot be activated when touched.

To lock/unlock the controls and cooktop:

- 1 Touch and hold the **CONTROL LOCK** pad for 3 seconds.
The oven display will show "**Oven controls and burners locked**" for several seconds, then "**Range Locked.**"

- 2 To unlock the control, touch and hold **CONTROL LOCK** for 3 seconds.

■ The **CONTROL LOCK** mode affects all touch pads. No touch pads will work when this feature is activated.

Adjust the upper or lower oven thermostat—Do it yourself!

You may find that your new oven cooks differently than the one it replaced. Use your new oven for a few weeks to become more familiar with it. If you still think your new oven is too hot or too cold, you can adjust the thermostat yourself.

Do not use thermometers, such as those found in grocery stores, to check the temperature setting of your oven. These thermometers may vary 20–40 degrees.

NOTE: This adjustment will only affect baking and roasting temperatures; it will not affect broiling or self-cleaning temperatures. The adjustment will be retained in memory after a power failure.

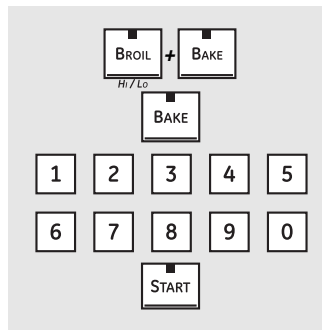

To Adjust the Thermostat

1 Touch the **BROIL HI/LO** and **BAKE** pads at the same time until the display shows **SF**.

2 Touch the **BAKE** pad. A two digit number shows in the display.

Touch **BAKE** again to alternate between increasing and decreasing the oven temperature.

To adjust the upper oven thermostat, touch the upper Oven **BAKE** pad. To adjust the lower oven thermostat, touch the lower Oven **BAKE** pad.

3 The oven temperature can be adjusted up to (+) 35°F hotter or (-) 35°F cooler. Touch the number pads the same way you read them. For example, to change the oven temperature 15°F, touch **1** and **5**.

4 When you have made the adjustment, touch the **START** pad to go back to the time of day display. Use your oven as you would normally.

The type of margarine will affect baking performance!

Most recipes for baking have been developed using high fat products such as butter or margarine (80% fat). If you decrease the fat, the recipe may not give the same results as with a higher fat product.

Recipe failure can result if cakes, pies, pastries, cookies or candies are made with low fat spreads. The lower the fat content of a spread product, the more noticeable these differences become.

Federal standards require products labeled “margarine” to contain at least 80% fat by weight. Low fat spreads, on the other hand, contain less fat and more water. The high moisture content of these spreads affects the texture and flavor of baked goods. For best results with your old favorite recipes, use margarine, butter or stick spreads containing at least 70% vegetable oil.

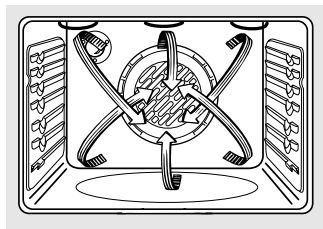

Convection Fan Operation

In a convection oven, a fan circulates hot air over, under and around the food.

This circulating hot air is evenly distributed throughout the oven cavity. As a result, foods are evenly cooked and browned—often in less time with convection heat.

NOTE: To maximize cooking evenness, the fan is designed to rotate in both directions, with a pause in between. This is normal.

The convection fan shuts off when the oven door is opened. **DO NOT** leave the door open for long periods of time while using convection cooking or you may shorten the life of the convection heating element.

Introduction

The convection oven comes with two convection baking modes: Convection Bake Multi and Convection Bake 1 Rack:

MULTI—for convection cooking on more than one rack. Touch the **CONVECTION BAKE MULTI/1 RACK** pad and then the **2** pad. See the *Multi-Rack Convection Baking* section below.

1 RACK—for convection cooking on one rack only. Touch the **CONVECTION BAKE MULTI/1 RACK** and then the **1** pad. See the *1-Rack Convection Baking* section below.

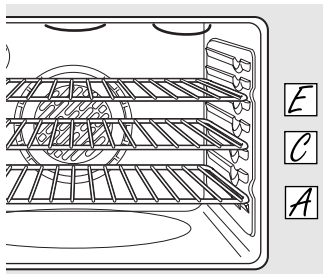

Multi-rack position.

Multi-Rack Convection Baking

Because heated air is circulated evenly throughout the oven, foods can be baked with excellent results using multiple racks.

Multi-rack baking may increase cook times slightly for some foods but the overall result is time saved. Cookies, muffins, biscuits and other quickbreads give very good results with multi-rack baking.

To cook food on more than one rack in convection bake, use **CONVECTION BAKE MULTI**.

When baking on 3 racks, place one rack in the second (A) position, another rack in the fourth (C) position and the third rack in the sixth (E) position.

For two-rack baking, place one rack in the second (B) rack position. Place the other rack in the fifth (E) rack position.

1-Rack Convection Baking

When convection baking with only 1 rack, use **CONVECTION BAKE 1 RACK** and follow the rack positions recommended in the *Using the oven section*.

■ Ideal for baked foods cooked on 1 rack.

Adapting Recipes...

You can use your favorite recipes in the convection oven.

When convection baking, the Auto Recipe™ Conversion feature automatically reduces the set regular baking temperature by the recommended 25°F. See Auto Recipe™ Conversion in the Special Features section.

- Use pan size recommended.
- Some package instructions for frozen casseroles or main dishes have been developed using commercial convection ovens. For best results in this oven, preheat the oven and use the temperature on the package.

Using the convection oven. (on some models)

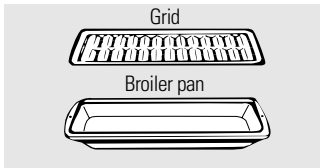

Convection Roast

- Good for large tender cuts of meat, uncovered.

The convection fan circulates the heated air evenly over and around the food. Meat and poultry are browned on all sides as if they were cooked on a rotisserie. The heated air seals in juices quickly for a moist and tender product while, at the same time, creating a rich golden brown exterior.

When you are convection roasting it is important that you use a broiler pan and grid for best convection roasting results. The pan is used to catch grease spills and the grid is used to prevent grease spatters.

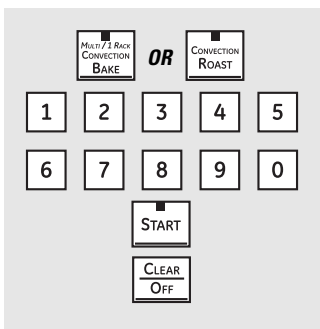

How to Set the Lower Oven for Convection Baking or Roasting

- 1 Touch the **CONVECTION BAKE MULTI/1 RACK** pad and then the **2** pad for multi-rack convection baking. This mode is used for cooking food items on more than one rack (i.e., 2, 3 or more racks) at the same time in convection bake. See the *Multi-Rack Convection Baking* section for more information.

Touch the **CONVECTION BAKE MULTI/1 RACK** pad and then the **1** pad for one-rack convection baking. This mode is used for cooking food items on only one rack in convection bake.

Touch the **CONVECTION ROAST** pad for convection roasting.

- 2 Touch the number pads to set the oven temperature.
- 3 Touch the **START** pad.

NOTE: If the *Auto Recipe™ Conversion Feature* is on, it will automatically reduce the set regular baking temperature by 25°F to the appropriate

convection temperature in convection bake mode. See *Auto Recipe™ Conversion in the Special Features* section.

To change the oven temperature, touch the **CONVECTION BAKE MULTI/1 RACK** or **CONVECTION ROAST** pad and then the number pads to set the new temperature.

When the oven starts to heat, the changing temperature, starting at 100°F, will be displayed. When oven reaches the temperature you set, 3 beeps will sound.

- 4 Touch **CLEAR/OFF** pad when finished.

- You will hear a fan while cooking with convection. The fan will stop when the door is opened, but the heat will not turn off.

- You may hear the oven clicking during baking. This is normal.

- In convection bake modes, for maximum cooking evenness, the fan is designed to rotate in both directions, with a pause in between. This is normal.

When baking cookies, you will get the best results if you use a flat cookie sheet instead of a pan with low sides.

Cookware for Convection Cooking

Before using your convection oven, check to see if your cookware leaves room for air circulation in the oven. If you are baking with several pans, leave space between them. Also, be sure the pans do not touch each other or the walls of the oven.

Paper and Plastic

Heat-resistant paper and plastic containers that are recommended for use in regular baking can also be used for convection baking, but should not be used at temperatures higher than the temperature recommended by the cookware manufacturer. Plastic cookware

that is heat-resistant to temperatures of 400°F can also be used.

Metal and Glass

Any type of cookware will work in your convection oven. However, metal pans heat the fastest and are recommended for convection baking.

- Darkened or matte-finished pans will bake faster than shiny pans.

- Glass or ceramic pans cook more slowly.

For recipes like oven-baked chicken, use a pan with low sides. Hot air cannot circulate well around food in a pan with high sides.

Using the timed features for convection cooking. (on some models) ge.com

You will hear a fan while cooking with these features. The fan will stop when the door is opened, but the heat will not turn off.

NOTE: Foods that spoil easily—such as milk, eggs, fish, stuffings, poultry and pork—should not be allowed to sit for more than 1 hour before or after cooking. Room temperature promotes the growth of harmful bacteria. Be sure that the oven light is off because heat from the bulb will speed harmful bacteria growth.

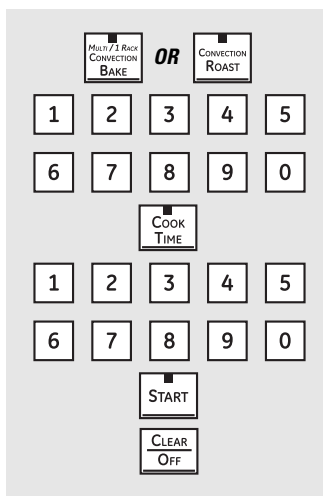

How to Set an Immediate Start and Automatic Stop

The lower oven will turn on immediately and cook for a selected length of time. At the end of the cooking time, the oven will turn off automatically.

Make sure the clock shows the correct time of day.

- 1 Touch the **CONVECTION BAKE MULTI/1 RACK** pad and then the **2** pad for multi-rack convection baking. This mode is used for cooking food items on more than one rack (i.e., 2, 3 or more racks) at the same time in convection bake. See *Multi-Rack Baking* section for more information.

Touch the **CONVECTION BAKE MULTI/1 RACK** pad and then the **1** pad for one-rack convection baking. This mode is used for cooking food items on only one rack in convection bake.

Touch the **CONVECTION ROAST** pad for convection roasting.

- 2 Touch the number pads to set the oven temperature.
- 3 Touch the **COOK TIME** pad.

NOTE: If your recipe requires preheating, you may need to add additional time to the length of the cooking time.

- 4 Touch the number pads to set the desired length of cooking time. The minimum cooking time you can set is 1 minute. The oven temperature that you set and the cooking time that you entered will be in the display.

- 5 Touch the **START** pad.

The oven will turn **ON**, and the display will show the cooking time countdown and the changing temperature starting at 100°F. (The temperature display will start to change once the oven temperature reaches 100°F.) When the oven reaches the temperature you set, 3 beeps will sound.

NOTE: If the Auto Recipe™ Conversion Feature is on, it will automatically reduce the set regular baking temperature by 25°F to the appropriate convection temperature in convection bake mode. See *Auto Recipe™ Conversion in the Special Features* section.

The oven will continue to cook for the set amount of time, then turn off automatically, unless the WARM feature was set. See the *How to Set the Oven for Warming* section.

After the oven turns off, the end-of-cycle tone will sound.

- 6 Touch the **CLEAR/OFF** pad to clear the display if necessary. Remove the food from the oven. Remember, even though the oven turns off automatically, food left in the oven will continue cooking after the oven turns off.

Using the timed features for convection cooking. (on some models)

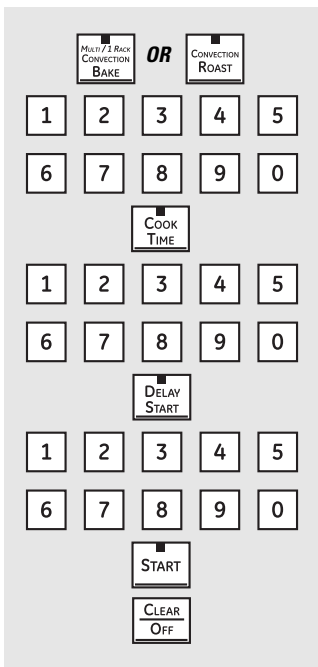

How to Set a Delayed Start and Automatic Stop

The lower oven will turn on at the time of day you set, cook for a specific length of time and then turn off automatically.

Make sure the clock shows the correct time of day.

- 1 Touch the **CONVECTION BAKE MULTI/1 RACK** pad and then the **2** pad for multi-rack convection baking. This mode is used for cooking food items on more than one rack (i.e., 2, 3 or more racks) at the same time in convection bake. See *Multi-Rack Baking* section for more information.

Touch the **CONVECTION BAKE MULTI/1 RACK** pad and then the **1** pad for one-rack convection baking. This mode is used for cooking food items on only one rack in convection bake.

Touch the **CONVECTION ROAST** pad for convection roasting.

- 2 Touch the number pads to set the oven temperature.
- 3 Touch the **COOK TIME** pad.

NOTE: If your recipe requires preheating, you may need to add additional time to the length of the cooking time.

- 4 Touch the number pads to set the desired length of cooking time. The minimum cooking time you can set is 1 minute.

The oven temperature that you set and the cooking time that you entered will be in the display.

- 5 Touch the **DELAY START** pad.
- 6 Touch the number pads to set the time of day you want the oven to turn on and start cooking.
- 7 Touch the **START** pad.

NOTE: An attention tone will sound if you are using timed baking or roasting and do not touch the **START** pad.

NOTE: If you would like to check the times you have set, touch the **DELAY START** pad to check the start time you have set, or touch the **COOK TIME** pad to check the length of cooking time you have set.

When the oven turns **ON** at the time of day you set, the display will show the cooking time countdown and the changing temperature starting at 100°F. (The temperature display will start to change once the oven temperature reaches 100°F.) When the oven reaches the temperature you set, 3 beeps will sound.

NOTE: If the Auto Recipe™ Conversion Feature is on, it will automatically reduce the set regular baking temperature by 25°F to the appropriate convection temperature in convection bake mode. See Auto Recipe™ Conversion in the Special Features section.

The oven will continue to cook for the programmed amount of time, then shut off automatically, unless the WARM feature was set. See the *How to Set the Oven for Warming* section.

After the oven turns off, the end-of-cycle tone will sound.

- 8 Touch the **CLEAR/OFF** pad to clear the display if necessary. Remove the food from the oven. Remember, even though the oven shuts off automatically, food left in the oven will continue cooking after the oven turns off.

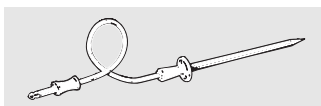

For best results when roasting large turkeys and roasts, we recommend using the probe included in the convection oven.

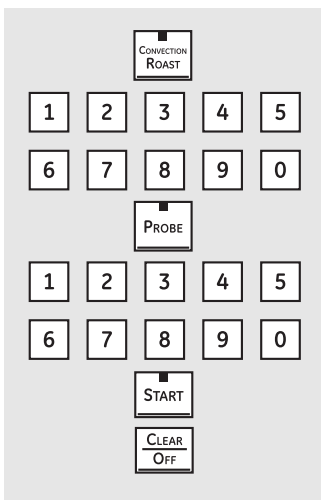

To change the oven temperature during the Convection Roast cycle, touch the **CONVECTION ROAST** pad and then touch the number pads to set the new desired temperature.

How to Set the Lower Oven for Convection Roasting when Using the Probe

- 1 Place the oven rack in the position that centers the food between the top and bottom of the oven. Insert the probe into the meat. Make sure it is pushed all the way in.
- 2 Plug the probe into the outlet in the oven. Make sure it is pushed all the way in. Close the oven door.
- 3 Touch the **PROBE** pad.
- 4 Touch the number pads to set the desired internal meat temperature.
- 5 Touch the **CONVECTION ROAST** pad.
- 6 Touch the number pads to set the desired oven temperature.
- 7 Touch the **START** pad.
- 8 When the internal temperature of the meat reaches the number you have set, the probe and the oven turn off and the oven control signals. To stop the signal, touch the **CLEAR/OFF** pad. Use hot pads to remove the probe from the food. Do not use tongs to pull on it—they might damage it.

NOTE: The maximum internal temperature for the food that you can set is 200°F.

- 5 Touch the **CONVECTION ROAST** pad.
- 6 Touch the number pads to set the desired oven temperature.

The display will flash **PROBE** and the oven control will signal if the probe is inserted into the outlet, and you have not set a probe temperature and pressed the **START** pad.

- 7 Touch the **START** pad.
- When the oven starts to heat, the word **LO** will be in the display.

After the internal temperature of the meat reaches 100°F, the changing internal temperature will be shown in the display.

NOTE: If the probe is removed from the oven while probe cooking, the oven will not automatically turn off.

CAUTION: To prevent possible burns, do not unplug the probe from the oven outlet until the oven has cooled.

NOTE:

- You will hear a fan while cooking with this feature. The fan will stop when the door is opened, but the heat will not turn off.
- You can use the Kitchen Timer even though you cannot use timed oven operations.
- Never leave your probe inside the oven during a self-cleaning cycle.
- Do not store the probe in the oven.
- Probe not for use in Broil or Self-Clean functions.
- Fan only rotates in one direction.

Convection Roasting Guide

Meat		Minutes/Lb.	Oven Temp.	Internal Temp.
Beef	Rib, Boneless Rib, Top Sirloin (3 to 5 lbs.)	Rare 31–35 Medium 35–39 Well	325°F 325°F 325°F	140°F† 160°F 170°F
	Beef Tenderloin	Rare 17–21 Medium 21–25	325°F 325°F	140°F† 160°F
	Pork	Bone-In, Boneless (3 to 5 lbs.)	30–34	325°F 170°F
Ham	Canned, Butt, Shank (3 to 5 lbs. fully cooked)	2 chops	37–42 total	325°F 170°F
		4 chops	42–47 total	325°F 170°F
		6 chops	47–52 total	325°F 170°F
Seafood	Lobster Tails (6 to 8 oz. each)	20–25 total	350°F	
Poultry	Whole Chicken (2½ to 3½ lbs.)	31–33	350°F	180°–185°F
	Turkey (18 to 24 lbs.)*	7–10	325°F	180°–185°F

* Stuffed birds generally require 30–45 minutes additional roasting time. Shield legs and breast with foil to prevent overbrowning and drying of skin.

† The U.S. Department of Agriculture says “Rare beef is popular, but you should know that cooking it to only 140°F means some food poisoning organisms may survive.” (Source: Safe Food Book. Your Kitchen Guide. USDA Rev. June 1985.)

Using the slow cook, pizza and warming features.

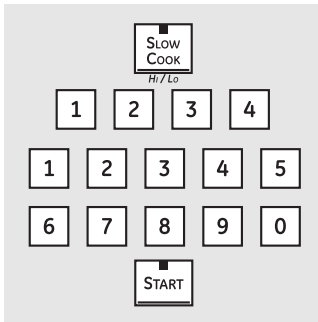

How to Set the Lower Oven For Slow Cook

Slow Cook is designed for long hours of unattended cooking.

- 1 Touch the **SLOW COOK** pad once for HI Slow Cook.

To change to LO Slow Cook, touch the **SLOW COOK** pad again.

- 2 Touch the number pads to select the desired setting – 1 for Beef, 2 for Poultry, 3 for Pork or 4 for Stews. Use 1–Beef if you are unsure which setting to use.
- 3 Touch the number pads to set the desired length of cooking time. For the HI setting, the cooking time must be between 3 and 8 hours. For the LO setting, the cooking time must be between 3 and 12 hours.
- 4 Touch the **START** pad.

When the **Slow Cook** function has completed, the oven will go into the Warm mode. Display will say “Cooking Complete Keeping Warm.” The total time the oven will be on (Slow Cook time plus Warm time) is 12 hours. This is because of the safety 12-Hour Shutdown feature described on page 28.

NOTE: If a power outage occurs while the oven is in Slow Cook, the range will shut off.

Slow Cook Guide

Food	Quantity	30" Ovens Rack Position	30" Ovens Food Setting	30" Ovens Time (Hours)	Comments
Beef Chuck Roast	3–3½ lbs	C	1-Beef	HI 5–6 hrs. LO 8–10 hrs.	Add 1/2 cup liquid.
Beef Ribs	3½–4 lbs	C	1-Beef	HI 3–4 hrs. LO 6–8 hrs.	Place ribs in a single layer.
Poultry Whole Chicken	4 lbs	C	2-Poultry	HI 4–5 hrs. LO 7–9 hrs.	Add 1/2 cup liquid.
Chicken Pieces	8 pieces (approx. 3 lbs.)	C	2-Poultry	HI 3–4 hrs. LO 5–6 hrs.	Best submerged under a sauce to prevent surface drying.
Pork Boneless Blade Roast	3–4 lbs	C	3-Pork	HI 5–6 hrs. LO 8–10 hrs.	Add 1/2–1 cup liquid.
Country Style Pork Ribs	3½–4 lbs	C	3-Pork	HI 3–4 hrs. LO 6–8 hrs.	Place ribs in a single layer.
Pork Chops	4–8	C	3-Pork	HI 3–4 hrs. LO 6–8 hrs.	Place chops in a single layer.
Soup Vegetable Beef Soup	4 quarts	C	4-Stew	HI 4–5 hrs. LO 8–10 hrs.	Make sure beef chunks are submerged.
Chili	4 quarts	C	4-Stew	HI 3–4 hrs. LO 6–8 hrs.	Submerge beans to prevent surface drying.

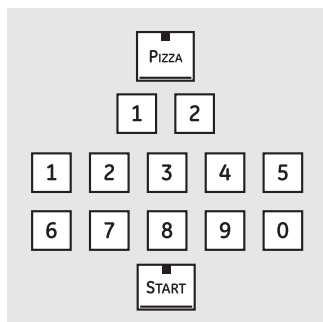

How to Set the Upper Oven For Pizza

Adjust rack position for type of pizza tray being used (see chart).

Type of Pizza Tray	Rack Position
Tray supplied with fresh pizza	B
Pizza placed directly on rack	B
Metal tray	A

- 1 Touch the **PIZZA** pad
- 2 Touch the number pads to select 1 for fresh or 2 for frozen pizza.
- 3 Touch the number pads to set the baking temperature.
- 4 Touch the **START** pad.

Baking time is determined by package directions.

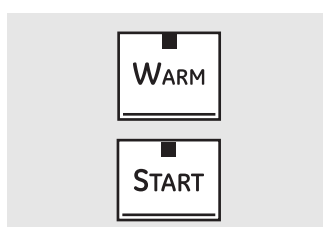

How to Set the Lower and Upper Ovens For Warming

The **WARM** feature keeps cooked foods hot.

This feature is not designed to reheat cold food.

To use the **WARM** feature, touch the **WARM** pad and then the **START** pad.

To use the **WARM** feature after Timed Baking or Roasting, follow these steps:

- 1 Touch the mode of cooking that you want to use (**BAKE, CONVECTION BAKE MULTI, CONVECTION BAKE 1 RACK** or **CONVECTION ROAST**).
- 2 Touch the number pads to set the oven temperature.
- 3 Touch the **COOK TIME** pad.
- 4 Touch the number pads to set the desired length of cooking time.
- 5 Touch the **WARM** pad.
- 6 Touch the **START** pad.

To Crisp Stale Items

- Place food in low-sided dishes or pans.
- For best results, place the food items in a single layer. Do not stack.

- Leave them uncovered.
- Check crispness after 20–30 minutes. Add time as needed.

IMPORTANT NOTES:

- Food should be kept hot in its cooking container or transferred to a heat-safe serving dish.
- For moist foods, cover them with an oven-safe lid or aluminum foil.
- Fried or crisp foods do not need to be covered, but can become too dry if warmed for too long.
- Repeated opening of the door allows the hot air to escape and the food to cool.
- Allow extra time for the temperature inside the oven to stabilize after adding items.
- With large loads it may be necessary to cover some of the cooked food items.
- Remove serving spoons, etc., before placing containers in the oven.
- Do not use plastic containers, lids or plastic wrap.

CAUTION: Plastic containers, lids or plastic wrap will melt if placed in the oven. Melted plastic may not be removable and is not covered under your warranty.

Using the self-cleaning upper and lower ovens.

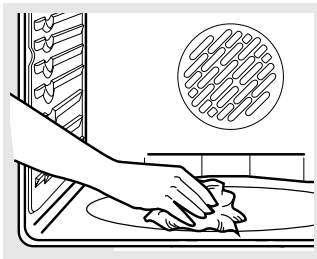

Wipe up heavy soil on the oven bottom.

Before a Clean Cycle

We recommend venting your kitchen with an open window or using a ventilation fan or hood during the first self-clean cycle.

Remove any broiler pan, broiler grid, probe, all cookware and any aluminum foil from the oven.

NOTE:

- If your oven is equipped with shiny, silver-colored oven racks, remove them before you begin the self-clean cycle.
- If your oven is equipped with gray porcelain-coated oven racks, they may be left in the oven during the self-clean cycle.

Soil on the front frame of the range and outside the gasket on the door will need to be cleaned by hand. Clean these areas with hot water, soap-filled steel-wool pads or cleansers such as Soft Scrub®. Rinse well with clean water and dry.

Do not clean the gasket. The fiberglass material of the oven door gasket cannot withstand abrasion. It is essential for the gasket to remain intact. If you notice it becoming worn or frayed, replace it.

Wipe up any heavy spillovers on the oven bottom.

Make sure the oven light bulb cover is in place and the oven light is off.

IMPORTANT: The health of some birds is extremely sensitive to the fumes given off during the self-cleaning cycle of any range. Move birds to another well-ventilated room.

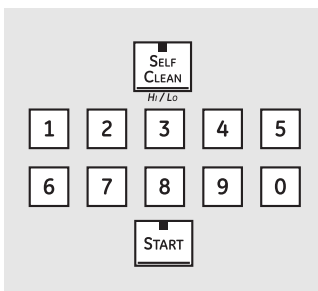

How to Set the Upper/Lower Oven for Cleaning

The oven doors must be closed and all controls set correctly for the cycle to work properly.

- 1 Touch the **SELF CLEAN HI/LO** pad once for a 5-hour clean time or twice for a 3-hour clean time.
- 2 A 3-hour self-clean time is recommended for use when cleaning small, contained spills. A self-clean time of 5 hours is recommended for a dirtier oven.
- 2 If a time other than 5 hours or 3 hours is needed, use the number pads and enter the desired clean time.

You can change the clean time to any time between 3 hours and 5 hours, depending on how dirty your oven is.

- 3 Touch the **START** pad.

The upper and lower oven doors lock automatically. The cooktop elements are also locked out during self-clean. The display will show the clean time remaining. It will not be possible to

open the oven doors or use the cooktop until the temperature drops below the lock temperature and **LOCKED** goes off in the control display.

When **LOCKED** goes off, you will be able to open the doors.

- The word **LOCKED** will flash and the word **door** will display if you set the clean cycle and forget to close the oven doors.
- To stop a clean cycle, touch the **CLEAR/OFF** pad. When **LOCKED** goes off, indicating the ovens have cooled below the locking temperature, you will be able to open the doors.

You can set a clean cycle in both ovens at the same time; however, they will not self-clean at the same time. The last oven set will automatically delay its start until the end of the first oven's clean cycle.

When an oven is set to self-clean, both oven doors will lock and the cooktop controls will lock out. The ovens and cooktop cannot be used when an oven is set to self-clean.

The oven doors must be closed and all controls set correctly for the cycle to work properly.

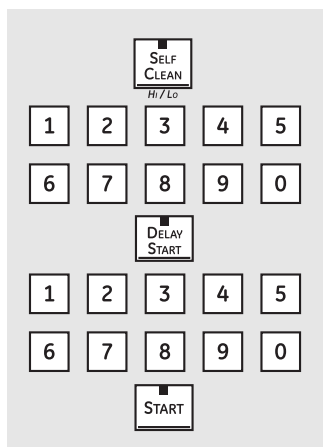

How to Delay the Start of Cleaning

- 1 Touch the **SELF CLEAN HI/LO** pad once for a 5-hour clean time or twice for a 3-hour clean time.
- A 3-hour self-clean time is recommended for use when cleaning small, contained spills. A self-clean time of 5 hours is recommended for a dirtier oven.
- 2 If a time other than 5 hours or 3 hours is needed, use the number pads and enter the desired clean time.

You can change the clean time to any time between 3 hours and 5 hours, depending on how dirty your oven is.

- 3 Touch the **DELAY START** pad.
- 4 Using the number pads, enter the time of day you want the clean cycle to start.
- 5 Touch the **START** pad.

The upper and lower oven doors lock automatically. The cooktop elements are also locked out during self-clean. The display will show the start time. It will not be possible to open the oven doors or use the cooktop until the temperature drops below the lock temperature and **LOCKED** goes off in the control display.

When **LOCKED** goes off, you will be able to open the doors.

After a Clean Cycle

You may notice some white ash in the oven. Wipe it up with a damp cloth after the oven cools.

If white spots remain, remove them with a soap-filled steel wool pad and rinse thoroughly with a vinegar and water mixture.

These deposits are usually a salt residue that cannot be removed by the clean cycle.

If the oven is not clean after one clean cycle, repeat the cycle.

- You cannot set the oven for cooking or another self-clean cycle until the oven is cool enough for the door to unlock.
- While the oven is self-cleaning, you can touch the **TIMER/CLOCK** or **CLOCK** pad (depending on model) to display the time of day. To return to the clean countdown, touch the **SELF CLEAN HI/LO** pad.
- If the racks become hard to slide, apply a small amount of cooking oil to a paper towel and wipe the edges of the oven racks with the paper towel.

Special features of your oven control.

Your new touch pad control has additional features that you may choose to use. The following are the features and how you may activate them.

The special feature modes can only be activated while the display is showing the time of day. They remain in the control's memory until the steps are repeated.

To enter a special feature for either oven, you must first touch the **upper oven BROIL HI/LO** and **BAKE** pads at the same time. The **lower oven BROIL HI/LO** and **BAKE** pads will not activate special features.

When the display shows your choice, touch the **START** pad. The special features will remain in memory after a power failure, except for the Sabbath feature, which will have to be reset.

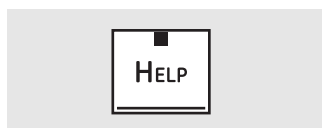

Help Function

Touch this pad to get additional information on the keypad of your choice.

Touch the **HELP** pad and the display will show "**Press keypad for help on that feature or 1 for options.**"

The options on pages 28 and 29 can be adjusted using the method described here or through **HELP**.

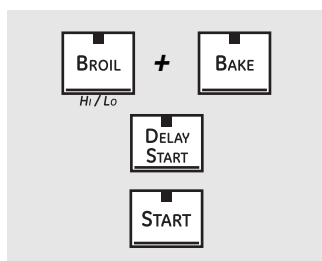

12-Hour Shutdown

With this feature, should you forget and leave the oven on, the control will automatically turn off the oven after 12 hours during baking functions or after 3 hours during a broil function.

If you wish to turn **OFF** this feature, follow the steps below.

- 1 Touch the **upper oven BROIL HI/LO** and **BAKE** pads at the same time until the display shows **SF**.

- 2 Touch the **DELAY START** pad until **no shdn** (no shut-off) appears in the display.
- 3 Touch the **START** pad to activate the no shut-off and leave the control set in this special features mode.

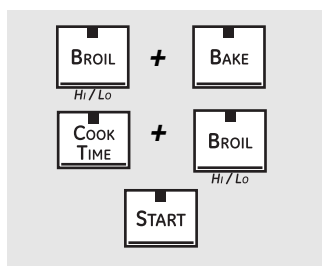

Fahrenheit or Celsius Temperature Selection

Your oven control is set to use the Fahrenheit temperature selections, but you may change this to use the Celsius selections.

- 1 Touch the **upper oven BROIL HI/LO** and **BAKE** pads at the same time until the display shows **SF**.

- 2 Touch the **COOK TIME** and **BROIL HI/LO** pads at the same time. The display will show **F** (Fahrenheit).
- 3 Touch the **COOK TIME** and **BROIL HI/LO** pads again at the same time. The display will show **C** (Celsius).
- 4 Touch the **START** pad.

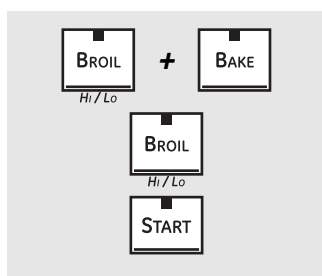

Tones at the End of a Timed Cycle

At the end of a timed cycle, 3 short beeps will sound followed by one beep every 6 seconds until the **CLEAR/OFF** pad is touched. This continual 6-second beep may be canceled.

To cancel the 6-second beep:

- 1 Touch the **upper oven BROIL HI/LO** and **BAKE** pads at the same time until the display shows **SF**.

- 2 Touch the **BROIL** pad. The display shows **CONTI BEEP** (continuous beep). Touch the **BROIL** pad again. The display shows **SINGLE BEEP**. (This cancels the one beep every 6 seconds.)
- 3 Touch the **START** pad.

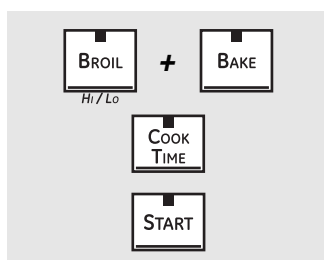

Tone Volume

This feature allows you to adjust the tone volumes to a more acceptable volume. There are three possible volume levels.

- 1 Touch the **upper oven BROIL HI/LO** and **BAKE** pads at the same time until the display shows **SF**.
- 2 Touch the **COOK TIME** pad. The display will show **2 BEEP**. This is the middle volume level.
Touch the **COOK TIME** pad again. The display will show **3 BEEP**. This is the loudest volume level.

Touch the **COOK TIME** pad again. The display will show **1 BEEP**. This is the quietest volume level.

For each time the level is changed, a tone will sound to provide an indication of the volume level.

- 3 Choose the desired sound level (**1 BEEP, 2 BEEP, 3 BEEP**).
- 4 Touch the **START** pad to activate the level shown.

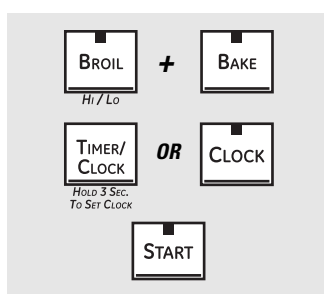

12-Hour, 24-Hour or Clock Blackout

Your control is set to use a 12-hour clock.

If you would prefer to have a 24-hour military time clock or black out the clock display, follow the steps below.

- 1 Touch the **upper oven BROIL HI/LO** and **BAKE** pads at the same time until the display shows **SF**.
- 2 Touch the **TIMER/CLOCK** or **CLOCK** pad (depending on model) once. The display will show **12 hr**. If this is the choice you want, touch the **START** pad.

Touch the **TIMER/CLOCK** or **CLOCK** pad (depending on model) again to change to the 24 hour military time clock. The display will show **24 hr**. If this is the choice you want, touch the **START** pad.

Touch the **TIMER/CLOCK** or **CLOCK** pad (depending on model) again to black out the clock display. The display will show **OFF**. If this is the choice you want, touch the **START** pad.

NOTE: If the clock is in the black-out mode you will not be able to use the Delay Start function.

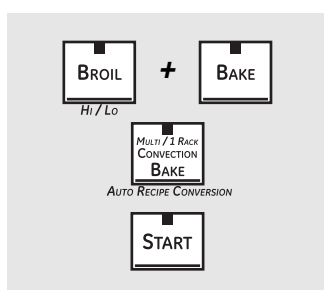

Auto Recipe™ Conversion

When using convection bake, the Auto Recipe™ Conversion feature will automatically convert entered regular baking temperatures to convection baking temperatures.

This feature is activated so that the display will show the actual converted (reduced) temperature. For example, if you enter a regular recipe temperature of 350°F and touch the **START** pad, the display will show **CON** and the converted temperature of 325°F.

To deactivate the feature:

- 1 Touch the **upper oven BAKE** and **BROIL HI/LO** pads at the same time until the display shows **SF**.
- 2 Touch the **CONVECTION BAKE MULTI/1 RACK** pad. The display will show **CON ON**. Touch the **CONVECTION BAKE MULTI/1 RACK** pad again. The display will show **CON OFF**.
- 3 Touch the **START** pad.

To reactivate the feature, repeat steps 1–3 above but touch the **START** pad when **CON ON** is in the display.

Using the Sabbath feature. (upper and lower ovens)

(Designed for use on the Jewish Sabbath and Holidays) (on some models)

The Sabbath feature can be used for baking/roasting only. It cannot be used for convection, broiling, self-cleaning or Delay Start cooking.

NOTE: The oven light comes on automatically (on some models) when the door is opened and goes off when the door is closed. The bulb may be removed. See the Oven Light Replacement section. On models with a light switch on the control panel, the oven light may be turned on and left on.

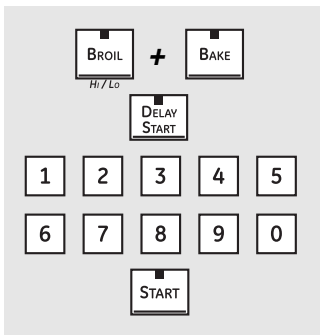

When the display shows □ the oven is set in Sabbath. When the display shows □ □ the oven is baking/roasting.

How to Set for Regular Baking/Roasting

Make sure the clock shows the correct time of day and the oven is off.

- 1 Touch and hold **both** the **BROIL HI/LO** and **BAKE** pads, **at the same time**, until the display shows **SF**.

NOTE: If bake or broil appears in the display, the **BROIL HI/LO** and **BAKE** pads were not touched at the same time. Touch the **CLEAR/OFF** pad and begin again.

- 2 Tap the **DELAY START** pad until **Sab bAtH** appears in the display.
- 3 Touch the **START** pad and □ will appear in the display.
- 4 Touch the **BAKE** pad. No signal will be given.

- 5 Using the number pads, enter the desired temperature between 170°F and 550°F. No signal or temperature will be given.

- 6 Touch the **START** pad.

- 7 After a random delay period of approximately 30 seconds to 1 minute, □ □ will appear in the display indicating that the oven is baking/roasting. If □ □ doesn't appear in the display, start again at Step 4.

To adjust the oven temperature, touch the **BAKE** pad, enter the new temperature using the number pads and touch the **START** pad.

NOTE: The **CLEAR/OFF** and **COOK TIME** pads are active during the Sabbath feature.

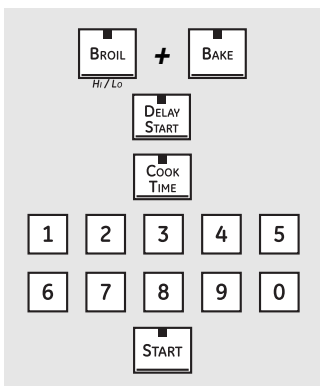

When the display shows □ the oven is set in Sabbath. When the display shows □ □ the oven is baking/roasting.

How to Set for Timed Baking/Roasting—Immediate Start and Automatic Stop

Make sure the clock shows the correct time of day and the oven is off.

- 1 Touch and hold **both** the **BROIL HI/LO** and **BAKE** pads, **at the same time**, until the display shows **SF**.

NOTE: If bake or broil appears in the display, the **BROIL HI/LO** and **BAKE** pads were not touched at the same time. Touch the **CLEAR/OFF** pad and begin again.

- 2 Tap the **DELAY START** pad until **Sab bAtH** appears in the display.
- 3 Touch the **START** pad and □ will appear in the display.
- 4 Touch the **COOK TIME** pad.
- 5 Touch the number pads to set the desired length of cooking time between 1 minute and 9 hours and 99 minutes. The cooking time that you entered will be displayed.

- 6 Touch the **START** pad.

- 7 Touch the **BAKE** pad. No signal will be given.

- 8 Using the number pads, enter the desired temperature. No signal or temperature will be given.

- 9 Touch the **START** pad.

- 10 After a random delay period of approximately 30 seconds to 1 minute, □ □ will appear in the display indicating that the oven is baking/roasting. If □ □ doesn't appear in the display, start again at Step 7.

To adjust the oven temperature, touch the **BAKE** pad, enter the new temperature using the number pads and touch the **START** pad.

When cooking is finished, the display will change from □ □ to □ and **0:00** will appear, indicating that the oven has turned **OFF** but is still set in Sabbath. Remove the cooked food.

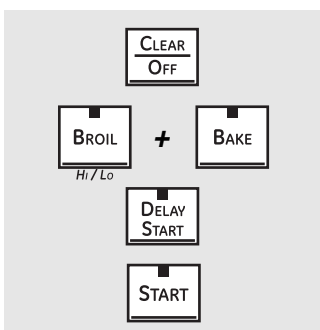

How to Exit the Sabbath Feature

- 1 Touch the **CLEAR/OFF** pad.
- 2 If the oven is cooking, wait for a random delay period of approximately 30 seconds to 1 minute, until only □ is in the display.
- 3 Touch and hold **both** the **BROIL HI/LO** and **BAKE** pads, **at the same time**, until the display shows **SF**.
- 4 Tap the **DELAY START** pad until **12 shdn** or **no shdn** appears in the display.

- 5 Choose **12 shdn**, indicating that the oven will automatically turn off after 12 hours or **no shdn**, indicating that the oven will not automatically turn off after 12 hours.

- 6 Press **START** when the option that you want is in the display (**12 shdn** or **no shdn**).

NOTE: If a power outage occurred while the oven was in Sabbath, the oven will automatically turn off and stay off even when the power returns. The oven control must be reset.

Care and cleaning of the range.

ge.com

Be sure all controls are off and all surfaces are cool before cleaning any part of the range.

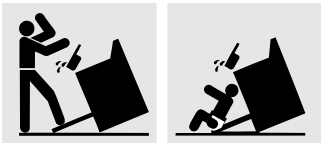

If your range is removed for cleaning, servicing or any reason, be sure the anti-tip device is re-engaged properly when the range is replaced. Failure to take this precaution could result in tipping of the range and cause injury.

How to Remove Protective Shipping Film and Packaging Tape

Carefully grasp a corner of the protective shipping film with your fingers and slowly peel it from the appliance surface. Do not use any sharp items to remove the film. Remove all of the film before using the appliance for the first time.

To assure no damage is done to the finish of the product, the safest way to remove the adhesive from packaging tape on new appliances is an application of a household liquid dishwashing detergent. Apply with a soft cloth and allow to soak.

NOTE: The adhesive must be removed from all parts. It cannot be removed if it is baked on.

Control Knobs

The control knobs may be removed for easier cleaning.

Make sure the knobs are in the **OFF** positions and pull them straight off the stems for cleaning.

The knobs can be cleaned in a dishwasher or they may also be washed with soap and water. Make sure the inside of the knobs are dry before replacing.

Replace the knobs in the **OFF** position to ensure proper placement.

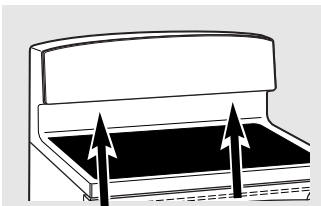

Oven Vent

The lower oven vent is located above the right rear surface unit. The upper oven vent is located above the left rear surface unit.

These areas could become hot during oven use.

It is normal for steam to come out of the vent.

The vent is important for proper air circulation. Never block this vent.

Control Panel

If desired, the touch pads may be deactivated before cleaning.

See the **Control Lock** information in the **Using the clock, kitchen timer and control lock** section in this manual.

Clean up splatters with a damp cloth.

You may also use a glass cleaner.

Remove heavier soil with warm soapy water. Do not use abrasives of any kind.

Reactivate the touch pads after cleaning.

Safety Instructions

Operating Instructions

Care and Cleaning

Troubleshooting Tips

Consumer Support

Care and cleaning of the range.

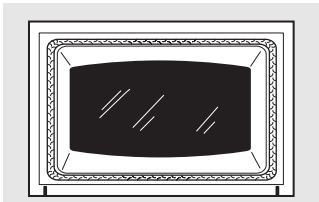

Do not rub or clean the door gasket—it has an extremely low resistance to abrasion.

If you notice the gasket becoming worn, frayed or damaged in any way or if it has become displaced on the door, you should have it replaced.

Cleaning the Upper and Lower Oven Doors

To clean the inside of the doors:

- Because the area inside the gasket is cleaned during the self-clean cycle, you do not need to clean this by hand.
- The area outside the gasket and the door liner can be cleaned with a soap-filled steel wool or plastic pad, hot water and detergent. Rinse well with a vinegar and water solution.

To clean the outside of the doors:

- Use soap and water to thoroughly clean the top, sides and front of the oven door. Rinse well. You may also use a glass cleaner to clean the glass on the outside of the door. Do not let water drip into the vent openings.
- If any stain on the door vent trim is persistent, use a soft abrasive cleaner and a sponge-scrubber for best results.
- Spillage of marinades, fruit juices, tomato sauces and basting materials containing acids may cause discoloration and should be wiped up immediately. When surface is cool, clean and rinse.
- Do not use oven cleaners, cleaning powders or harsh abrasives on the outside of the door.

Lift-Off Upper Oven Door

To remove the door:

- 1 Fully open the door.
- 2 Lift up on the hinge lock toward the oven frame until they stop.
- 3 Close the door to 45 degrees (you will feel the door stop). The hinge lock will contact the oven frame.
- 4 On both sides of the door, press down on the release buttons on each hinge.
- 5 Lift door up until it is clear of the hinge.
- 6 Pull on hinge arms slightly to relieve pressure on the locking tabs.
- 7 Push the hinge locks down onto the hinge.
- 8 Push the hinges in toward the unit so they are closed.

To replace the door:

- 1 Pull the hinges down away from the oven frame to the fully open position.
- 2 Lift up on the hinge locks toward the oven frame until they stop.
- 3 The hinges will release to the 45-degree position. The hinge locks will contact the oven frame.
- 4 Slide the door back onto the hinges. Make sure the buttons pop back out.
- 5 Fully open the door.
- 6 Push the hinge locks down onto the hinge.
- 7 Close the oven door.

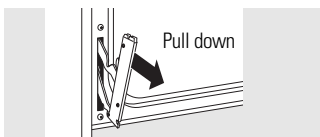
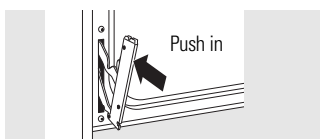
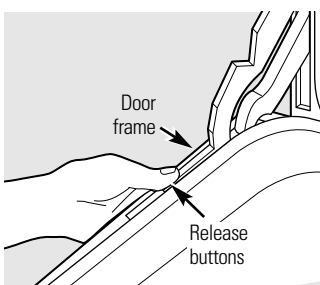
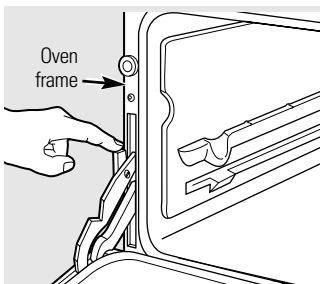

Lift-Off Lower Oven Door

The door is very heavy. Be careful when removing and lifting the door.

Do not lift the door by the handle.

To remove the door:

- 1 Fully open the door.
- 2 Pull the hinge locks down toward the door frame, to the unlocked position. A tool, such as a small flat-blade screwdriver, may be required.
- 3 Firmly grasp both sides of the door at the top.
- 4 Close door to the door removal position, which is halfway between the broil stop position and fully closed.
- 5 Lift door up and out until the hinge arm is clear of the slot.

To replace the door:

- 1 Firmly grasp both sides of the door at the top.

- 2 With the door at the same angle as the removal position, seat the indentation of the hinge arm into the bottom edge of the hinge slot. The notch in the hinge arm must be fully seated into the bottom of the slot.

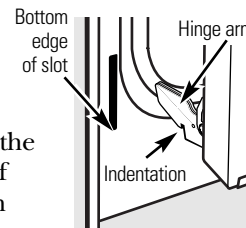

- 3 Fully open the door. If the door will not fully open, the indentation is not seated correctly in the bottom edge of the slot.
- 4 Push the hinge locks up against the front frame of the oven cavity to the locked position.

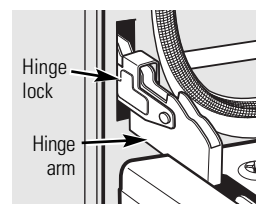

Push hinge locks up to lock.

- 5 Close the oven door.

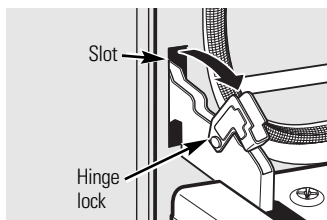

Pull hinge locks down to unlock.

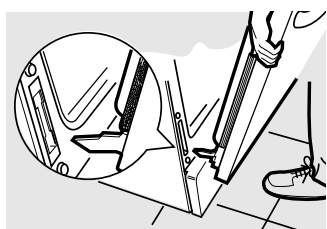

Removal position

Care and cleaning of the range.

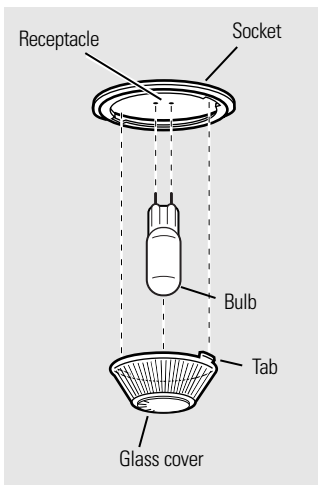

Oven Light Bulbs

NOTE: The glass cover should be removed only when cold. Wearing latex gloves may offer a better grip.

CAUTION: Before replacing your oven light bulb, disconnect the electrical power to the range at the main fuse or circuit breaker panel.

Be sure to let the light cover and bulb cool completely.

For your safety, do not touch a hot bulb with bare hands or a damp cloth.

To remove:

- 1 Turn the glass cover counterclockwise 1/4 turn until the tabs of the glass cover clear the grooves of the socket.
- 2 Using gloves or a dry cloth, remove the bulb by pulling it straight out.

To replace:

- 1 Use a new 130-volt halogen bulb, not to exceed 50 watts.
- 2 Using gloves or a dry cloth, remove the bulb from its packaging. Do not touch the bulb with bare fingers.

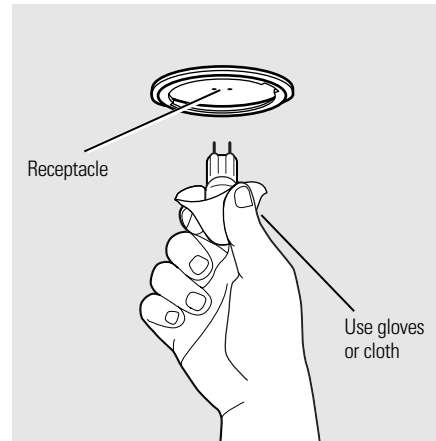

- 3 Push the bulb straight into the receptacle all the way.
- 4 Place the tabs of the glass cover into the grooves of the socket. Turn the glass cover clockwise 1/4 turn.

For improved lighting inside the oven, clean the glass cover frequently using a wet cloth. This should be done when the oven is completely cool.

- 5 Reconnect electrical power to the oven.

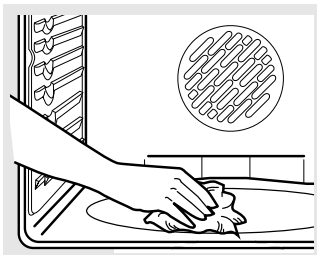

Wipe up heavy soil on the oven bottom.

Oven Heating Elements

Do not clean the broil element. Any soil will burn off when the element is heated. Clean the oven floor with warm, soapy water.

On some models, the bake element is not exposed and is under the oven floor. If spillovers, residue or ash accumulate on the oven floor, wipe up before self-cleaning.

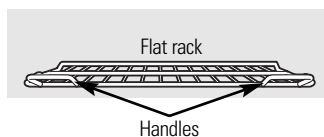

Use the rack with the two front handles in the upper oven.

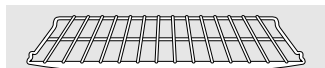

Use the rack without the two front handles in the lower oven.

Oven Racks

All oven racks may be cleaned by hand with an abrasive cleaner or steel wool. After cleaning, rinse the racks with clean water and dry with a clean cloth. Gray porcelain-coated oven racks may remain in the oven during the self-cleaning cycle without being damaged. The nickel-plated oven racks may remain in the oven

during the self-cleaning cycle, but they will lose their luster and become hard to slide. It will be necessary to grease all oven rack side edges with a light coating of vegetable oil after cleaning them by hand or in the oven. This will help maintain the ease of sliding the racks in and out of the oven.

Stainless Steel Surfaces (on some models)

Do not use a steel wool pad; it will scratch the surface.

To clean the stainless steel surface, use warm sudsy water or a stainless steel cleaner or polish. Always wipe the surface in the direction of the grain. Follow the cleaner instructions for cleaning the stainless steel surface.

To inquire about purchasing stainless steel appliance cleaner or polish, or to find the location of a dealer nearest you, please call our toll-free number:

National Parts Center **1.800.626.2002**
ge.com

Painted Surfaces

Painted surfaces include the door, top of the control panel and the drawer front. Clean these with soap and water or a vinegar and water solution.

Do not use commercial oven cleaners, cleaning powders, steel wool or harsh abrasives on any painted surface.

Cleaning the glass cooktop.



Clean your cooktop after each spill. Use CERAMA BRYTE® Ceramic Cooktop Cleaner.

Normal Daily Use Cleaning

ONLY use CERAMA BRYTE® Ceramic Cooktop Cleaner on the glass cooktop. Other creams may not be as effective.

To maintain and protect the surface of your glass cooktop, follow these steps:

- 1 Before using the cooktop for the first time, clean it with CERAMA BRYTE® Ceramic Cooktop Cleaner. This helps protect the top and makes cleanup easier.
- 2 Daily use of CERAMA BRYTE® Ceramic Cooktop Cleaner will help keep the cooktop looking new.

- 3 Shake the cleaning cream well. Apply a few drops of CERAMA BRYTE® Ceramic Cooktop Cleaner directly to the cooktop.
- 4 Use a paper towel or CERAMA BRYTE® Cleaning Pad for Ceramic Cooktops to clean the entire cooktop surface.
- 5 Use a dry cloth or paper towel to remove all cleaning residue. No need to rinse.

NOTE: It is very important that you **DO NOT** heat the cooktop until it has been cleaned thoroughly.

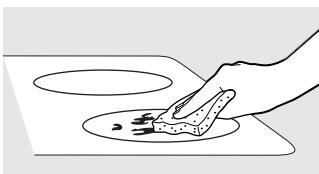

Use a CERAMA BRYTE® Cleaning Pad for Ceramic Cooktops.

Burned-On Residue

WARNING: DAMAGE to your glass surface may occur if you use scrub pads other than those recommended.

- 1 Allow the cooktop to cool.
- 2 Spread a few drops of CERAMA BRYTE® Ceramic Cooktop Cleaner on the entire burned residue area.
- 3 Using the included CERAMA BRYTE® Cleaning Pad for Ceramic Cooktops, rub the residue area, applying pressure as needed.

- 4 If any residue remains, repeat the steps listed above as needed.
- 5 For additional protection, after all residue has been removed, polish the entire surface with CERAMA BRYTE® Ceramic Cooktop Cleaner and a paper towel.

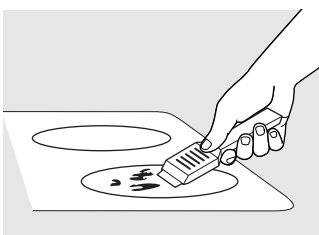

The CERAMA BRYTE® Ceramic Cooktop Scraper and all recommended supplies are available through our Parts Center. See instructions under "To Order Parts" section on next page.

NOTE: Do not use a dull or nicked blade.

Heavy, Burned-On Residue

- 1 Allow the cooktop to cool.
- 2 Use a single-edge razor blade scraper at approximately a 45° angle against the glass surface and scrape the soil. It will be necessary to apply pressure to the razor scraper in order to remove the residue.
- 3 After scraping with the razor scraper, spread a few drops of CERAMA BRYTE® Ceramic Cooktop Cleaner on the entire burned residue area. Use the CERAMA BRYTE® Cleaning Pad to remove any remaining residue.

- 4 For additional protection, after all residue has been removed, polish the entire surface with CERAMA BRYTE® Ceramic Cooktop Cleaner and a paper towel.

Metal Marks and Scratches

- 1 Be careful not to slide pots and pans across your cooktop. It will leave metal markings on the cooktop surface.
- 2 If pots with a thin overlay of aluminum or copper are allowed to boil dry, the overlay may leave black discoloration on the cooktop.

These marks are removable using the CERAMA BRYTE® Ceramic Cooktop Cleaner with the CERAMA BRYTE® Cleaning Pad for Ceramic Cooktops.

This should be removed immediately before heating again or the discoloration may be permanent.

WARNING: Carefully check the bottom of pans for roughness that would scratch the cooktop.

Rubber-like Seal

To clean the rubber-like seal at the outer edge of the glass, wipe it with cooktop cream when needed.

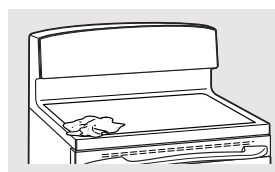

Glass surface—potential for permanent damage.

Sugary spillovers (such as jellies, fudge, candy, syrups) or melted plastics can cause pitting of the surface of your cooktop (not covered by the warranty) unless the spill is removed while still hot. Special care should be taken when removing hot substances.

Be sure to use a new, sharp razor scraper.

Do not use a dull or nicked blade.

Damage from Sugary Spills and Melted Plastic

- 1 Turn off all surface units. Remove hot pans.
- 2 Wearing an oven mitt:
 - a. Use a single-edge razor blade scraper (CERAMA BRYTE® Ceramic Cooktop Scraper) to move the spill to a cool area on the cooktop.
 - b. Remove the spill with paper towels.
- 3 Any remaining spillover should be left until the surface of the cooktop has cooled.
- 4 Don't use the surface units again until all of the residue has been completely removed.

NOTE: If pitting or indentation in the glass surface has already occurred, the cooktop glass will have to be replaced. In this case, service will be necessary.

To Order Parts

To order CERAMA BRYTE® Ceramic Cooktop Cleaner and the cooktop scraper, please call our toll-free number:

National Parts Center 800.626.2002
ge.com

CERAMA BRYTE® Ceramic Cooktop Cleaner# WX10X300

CERAMA BRYTE® Ceramic Cooktop Scraper# WX10X0302

Kit# WB64X5027
(Kit includes cream and cooktop scraper)

CERAMA BRYTE® Cleaning Pads for Ceramic Cooktops# WX10X350

Before you call for service...



Troubleshooting Tips

Save time and money! Review the charts on the following pages first and you may not need to call for service.

Problem	Possible Causes	What To Do
Surface units will not maintain a rolling boil or cooking is not fast enough	Improper cookware being used.	<ul style="list-style-type: none"> Use pans which are flat and match the diameter of the surface unit selected.
	In some areas, the power (voltage) may be low.	<ul style="list-style-type: none"> Cover pan with a lid until desired heat is obtained.
Surface units do not work properly	A fuse in your home may be blown or the circuit breaker tripped.	<ul style="list-style-type: none"> Replace the fuse or reset the circuit breaker.
	Cooktop controls improperly set.	<ul style="list-style-type: none"> Check to see the correct control is set for the surface unit you are using.
Surface unit stops glowing when turned to a lower setting	This is normal. The unit is still on and hot.	
Scratches (may appear as cracks) on cooktop glass surface	Incorrect cleaning methods being used.	<ul style="list-style-type: none"> Scratches are not removable. Tiny scratches will become less visible in time as a result of cleaning.
	Cookware with rough bottoms being used or coarse particles (salt or sand) were between the cookware and the surface of the cooktop. Cookware has been slid across the cooktop surface.	<ul style="list-style-type: none"> To avoid scratches, use the recommended cleaning procedures. Make sure bottoms of cookware are clean before use, and use cookware with smooth bottoms.
Areas of discoloration on the cooktop	Food spillovers not cleaned before next use.	<ul style="list-style-type: none"> See the <i>Cleaning the glass cooktop</i> section.
	Hot surface on a model with a light-colored cooktop.	<ul style="list-style-type: none"> This is normal. The surface may appear discolored when it is hot. This is temporary and will disappear as the glass cools.
Plastic melted to the surface	Hot cooktop came into contact with plastic placed on the hot cooktop.	<ul style="list-style-type: none"> See the <i>Glass surface—potential for permanent damage</i> section in the <i>Cleaning the glass cooktop</i> section.
Pitting (or indentation) of the cooktop	Hot sugar mixture spilled on the cooktop.	<ul style="list-style-type: none"> Call a qualified technician for replacement.
Frequent cycling off and on of surface units	Improper cookware being used.	<ul style="list-style-type: none"> Use only flat cookware to minimize cycling.
Oven light does not work	Light bulb is loose.	<ul style="list-style-type: none"> Tighten or replace the bulb.
Oven will not work	Plug on range is not completely inserted in the electrical outlet.	<ul style="list-style-type: none"> Make sure electrical plug is plugged into a live, properly grounded outlet.
	A fuse in your home may be blown or the circuit breaker tripped.	<ul style="list-style-type: none"> Replace the fuse or reset the circuit breaker.
	Oven controls improperly set.	<ul style="list-style-type: none"> See the <i>Using the oven</i> section.
	Oven too hot.	<ul style="list-style-type: none"> Allow the oven to cool to below locking temperature.

Problem	Possible Causes	What To Do
Food does not bake or roast properly	Oven controls improperly set.	• See the <i>Using the oven</i> section.
	Rack position is incorrect or the rack is not level.	• See the <i>Using the oven</i> section.
	Incorrect cookware or cookware of improper size being used.	• See the <i>Using the oven</i> section.
	Oven thermostat needs adjustment.	• See the <i>Adjust the oven thermostat—Do it yourself!</i> section.
Food does not broil properly	Oven controls improperly set.	• Make sure you touch the BROIL HI/LO pad.
	Improper rack position being used.	• See the <i>Broiling Guide</i> .
	Cookware not suited for broiling.	• For best results, use a pan designed for broiling.
	The probe is plugged into the outlet in the oven. (on some models)	• Unplug and remove the probe from the oven.
	In some areas the power (voltage) may be low.	• Preheat the broil element for 10 minutes. • Broil for the longest period of time recommended in the <i>Broiling Guide</i> .
Oven temperature too hot or too cold	Oven thermostat needs adjustment.	• See the <i>Adjust the oven thermostat—Do it yourself!</i> section.

Before you call for service...



Troubleshooting Tips

Problem	Possible Causes	What To Do
Clock and timer do not work	Plug on range is not completely inserted in the electrical outlet.	<ul style="list-style-type: none"> • Make sure electrical plug is plugged into a live, properly grounded outlet.
	A fuse in your home may be blown or the circuit breaker tripped.	<ul style="list-style-type: none"> • Replace the fuse or reset the circuit breaker.
	Oven controls improperly set.	<ul style="list-style-type: none"> • See the <i>Using the clock and timer</i> section.
Oven will not self-clean	The oven temperature is too high to set a self-clean operation.	<ul style="list-style-type: none"> • Allow the range to cool and reset the controls.
	Oven controls improperly set.	<ul style="list-style-type: none"> • See the <i>Using the self-cleaning oven</i> section.
	The probe is plugged into the outlet in the oven. (on some models)	<ul style="list-style-type: none"> • Remove the probe from the oven.
"Crackling" or "popping" sound	This is the sound of the metal heating and cooling during both the cooking and cleaning functions.	<ul style="list-style-type: none"> • This is normal.
Excessive smoking during a clean cycle	Excessive soil.	<ul style="list-style-type: none"> • Touch the CLEAR/OFF pad. Open the windows to rid the room of smoke. Wait until LOCKED goes off. Wipe up the excess soil and reset the clean cycle.
Oven door will not open after a clean cycle	Oven too hot.	<ul style="list-style-type: none"> • Allow the oven to cool below locking temperature.
Oven not clean after a clean cycle	Oven controls not properly set.	<ul style="list-style-type: none"> • See the <i>Using the self-cleaning oven</i> section.
	Oven was heavily soiled.	<ul style="list-style-type: none"> • Clean up heavy spillovers before starting the clean cycle. Heavily soiled ovens may need to self-clean again or for a longer period of time.
"LOCKED" flashes in the display	The self-clean cycle has been selected but the door is not closed.	<ul style="list-style-type: none"> • Close the oven door.
"LOCKED" is on when you want to cook	The oven door is locked because the temperature inside the oven has not dropped below the locking temperature.	<ul style="list-style-type: none"> • Touch the CLEAR/OFF pad. Allow the oven to cool.
"F—and a number or letter" flash in the display	You have a function error code.	<ul style="list-style-type: none"> • Disconnect all power to the range for at least 30 seconds and then reconnect power. If the function error code repeats, call for service.

Problem	Possible Causes	What To Do
Range Locked appears in the oven display	The controls have been locked.	<ul style="list-style-type: none"> • See the <i>Control Lock</i> section to unlock.
Control signals after entering cooking time or start time	You forgot to enter a bake temperature or cleaning time.	<ul style="list-style-type: none"> • Touch the BAKE pad and desired temperature or the SELF CLEAN HI/LO pad and desired clean time.
Display goes blank	A fuse in your home may be blown or the circuit breaker tripped.	<ul style="list-style-type: none"> • Replace the fuse or reset the circuit breaker.
	The clock is in the black-out mode.	<ul style="list-style-type: none"> • See the <i>Special features of your oven control</i> section.
Display flashes	Power failure.	<ul style="list-style-type: none"> • Reset the clock.
Unable to get the display to show "SF"	Oven control pads were not touched properly.	<ul style="list-style-type: none"> • The BROIL HI/LO and BAKE pads must be touched at the same time and held for 3 seconds.
"Probe" appears in the display (on some models)	This is reminding you to enter a probe temperature after plugging in the probe.	<ul style="list-style-type: none"> • Enter a probe temperature.
Power outage, clock flashes	Power outage or surge.	<ul style="list-style-type: none"> • Reset the clock. If the oven was in use, you must reset it by touching the CLEAR/OFF pad, setting the clock and resetting any cooking function.
Steam from the vent	When using the ovens, it is normal to see steam coming out of the oven vents. As the number of racks or amount of food being cooked increases, the amount of visible steam will increase.	<ul style="list-style-type: none"> • This is normal.
"Burning" or "oily" odor emitting from the vent	This is normal in a new oven and will disappear in time.	<ul style="list-style-type: none"> • To speed the process, set a self-clean cycle for a minimum of 3 hours. See the <i>Using the self-cleaning oven</i> section.
Strong odor	An odor from the insulation around the inside of the oven is normal for the first few times the oven is used.	<ul style="list-style-type: none"> • This is temporary.
Fan noise	A convection fan may automatically turn on and off.	<ul style="list-style-type: none"> • This is normal. To maximize cooking evenness, the fan is designed to operate in both directions, with a pause in between. • The convection fan will operate during preheat of the bake cycle. The fan will turn off after the oven is heated to the set temperature. This is normal.
Oven racks are difficult to slide	The shiny, silver-colored racks were cleaned in a self-clean cycle.	<ul style="list-style-type: none"> • Apply a small amount of vegetable oil to a paper towel and wipe the edges of the oven racks with the paper towel. Do not spray with Pam® or other lubricant sprays.

Consumer Support
Troubleshooting Tips
Care and Cleaning
Operating Instructions
Safety Instructions

Notes.

GE Service Protection Plus™

GE, a name recognized worldwide for quality and dependability, offers you Service Protection Plus™—comprehensive protection on all your appliances—**No Matter What Brand!**

Benefits Include:

- Backed by GE
- All brands covered
- Unlimited service calls
- All parts and labor costs included
- No out-of-pocket expenses
- No hidden deductibles
- One 800 number to call

***We'll Cover Any Appliance.
Anywhere. Anytime.****

You will be completely satisfied with our service protection or you may request your money back on the remaining value of your contract. No questions asked. It's that simple.

Protect your refrigerator, dishwasher, washer and dryer, range, TV, VCR and much more—**any brand!** Plus there's no extra charge for emergency service and low monthly financing is available. Even icemaker coverage and food spoilage protection is offered. You can rest easy, knowing that all your valuable household products are protected against expensive repairs.

Place your confidence in GE and call us in the U.S. toll-free at **800.626.2224** for more information.

*All brands covered, up to 20 years old, in the continental U.S.

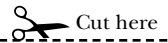

Please place in envelope and mail to:

General Electric Company
Warranty Registration Department
P.O. Box 32150
Louisville, KY 40232-2150

Consumer Product Ownership Registration

Dear Customer:

Thank you for purchasing our product and thank you for placing your confidence in us. We are proud to have you as a customer!

Follow these three steps to protect your new appliance investment:

1 Complete and mail your Consumer Product Ownership Registration today. Have the peace of mind of knowing we can contact you in the unlikely event of a safety modification.

2 After mailing the registration below, store this document in a safe place. It contains information you will need should you require service. Our service number is 800.GE.CARES (800.432.2737).

3 Read your Owner's Manual carefully. It will help you operate your new appliance properly.

Model Number

Serial Number

Important: If you did not get a registration card with your product, detach and return the form below to ensure that your product is registered, or register online at ge.com.

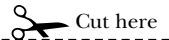

Consumer Product Ownership Registration



Model Number

Serial Number

Mr. Ms. Mrs. Miss

First Name _____

Last Name _____

Street Address _____

Apt. # _____

E-mail Address* _____

City _____

State _____

Zip Code _____

Date Placed In Use
Month _____

Day _____

Year _____

Phone Number _____-_____-_____

* Please provide your e-mail address to receive, via e-mail, discounts, special offers and other important communications from GE Appliances (GEA).

Check here if you do not want to receive communications from GEA's carefully selected partners.

FAILURE TO COMPLETE AND RETURN THIS CARD DOES NOT DIMINISH YOUR WARRANTY RIGHTS.

For more information about GEA's privacy and data usage policy, go to ge.com and click on "Privacy Policy" or call 800.626.2224.



GE Consumer & Industrial Appliances
General Electric Company
Louisville, KY 40225
ge.com

Notes.

<i>Safety Instructions</i>	<i>Operating Instructions</i>	<i>Care and Cleaning</i>	<i>Troubleshooting Tips</i>	<i>Consumer Support</i>
-----------------------------------	--------------------------------------	---------------------------------	------------------------------------	--------------------------------

Accessories.

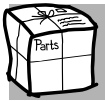

Looking For Something More?

You can find these accessories and many more at ge.com, or call **800.626.2002** (during normal business hours). Have your model number ready.

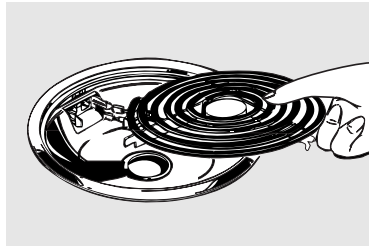

Surface Elements & Drip Pans

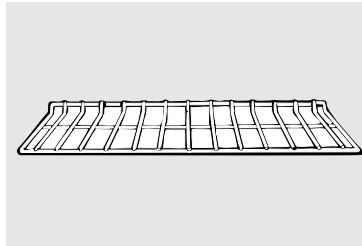

Oven Racks

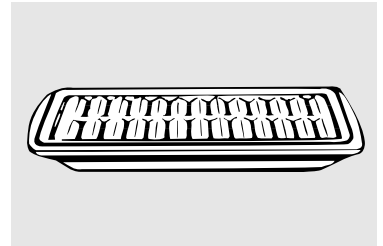

Broiler Pan

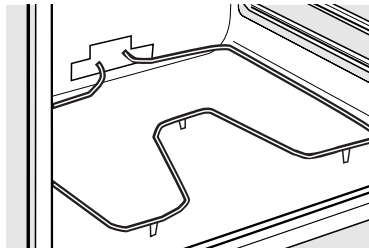

Oven Elements

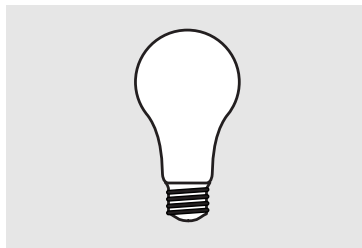

Light Bulbs

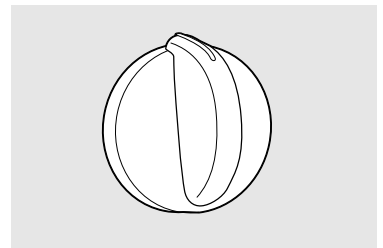

Knobs



Cleaner

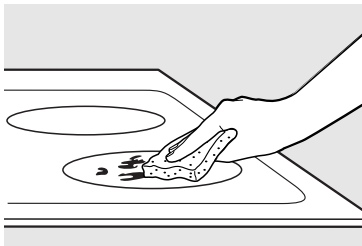

Cleaning Pads

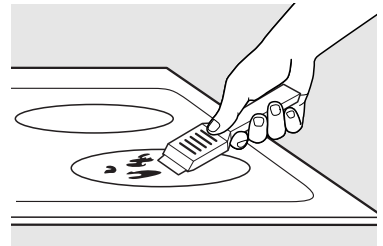

Scraper

Tired of discolored racks? Wishing you had extra-heavy-duty oven racks?

NOW AVAILABLE for your range:

GE's innovative, self-cleanable porcelain-coated oven racks!

- Heavy Duty
- Durable
- Able to be cleaned in a self-cleaning oven

Visit ge.com for more information.

GE Electric Range Warranty.



All warranty service provided by our Factory Service Centers, or an authorized Customer Care® technician. To schedule service, on-line, visit us at ge.com, or call 800.GE.CARES (800.432.2737). Please have serial number and model number available when calling for service.

Staple your receipt here. Proof of the original purchase date is needed to obtain service under the warranty.

For The Period Of:	GE Will Provide:
<p>One Year From the date of the original purchase</p>	<p>Any part of the range which fails due to a defect in materials or workmanship. During this limited one-year warranty, GE will also provide, free of charge, all labor and in-home service to replace the defective part.</p>

What GE Will Not Cover:

- Service trips to your home to teach you how to use the product.
- Improper installation, delivery or maintenance.
- Failure of the product if it is abused, misused, or used for other than the intended purpose or used commercially.
- Damage to the glass cooktop caused by use of cleaners other than the recommended cleaning creams and pads.
- Damage to the glass cooktop caused by hardened spills of sugary materials or melted plastic that are not cleaned according to the directions in the Owner's Manual.
- Replacement of house fuses or resetting of circuit breakers.
- Damage to the product caused by accident, fire, floods or acts of God.
- Incidental or consequential damage caused by possible defects with this appliance.
- Damage caused after delivery.
- Product not accessible to provide required service.

EXCLUSION OF IMPLIED WARRANTIES—Your sole and exclusive remedy is product repair as provided in this Limited Warranty. Any implied warranties, including the implied warranties of merchantability or fitness for a particular purpose, are limited to one year or the shortest period allowed by law.

This warranty is extended to the original purchaser and any succeeding owner for products purchased for home use within the USA. If the product is located in an area where service by a GE Authorized Servicer is not available, you may be responsible for a trip charge or you may be required to bring the product to an Authorized GE Service location for service. In Alaska, the warranty excludes the cost of shipping or service calls to your home.

Some states do not allow the exclusion or limitation of incidental or consequential damages. This warranty gives you specific legal rights, and you may also have other rights which vary from state to state. To know what your legal rights are, consult your local or state consumer affairs office or your state's Attorney General.

Warrantor: General Electric Company, Louisville, KY 40225

Safety Instructions
Operating Instructions
Care and Cleaning
Troubleshooting Tips
Consumer Support

Consumer Support



GE Appliances Website

ge.com

Have a question or need assistance with your appliance? Try the GE Appliances Website 24 hours a day, any day of the year! For greater convenience and faster service, you can now download Owner's Manuals, order parts or even schedule service on-line.

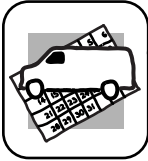

Schedule Service

ge.com

Expert GE repair service is only one step away from your door. Get on-line and schedule your service at your convenience any day of the year! Or call 800.GE.CARES (800.432.2737) during normal business hours.



Real Life Design Studio

ge.com

GE supports the Universal Design concept—products, services and environments that can be used by people of all ages, sizes and capabilities. We recognize the need to design for a wide range of physical and mental abilities and impairments. For details of GE's Universal Design applications, including kitchen design ideas for people with disabilities, check out our Website today. For the hearing impaired, please call 800.TDD.GEAC (800.833.4322).



Extended Warranties

ge.com

Purchase a GE extended warranty and learn about special discounts that are available while your warranty is still in effect. You can purchase it on-line anytime, or call 800.626.2224 during normal business hours. GE Consumer Home Services will still be there after your warranty expires.

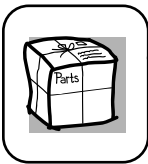

Parts and Accessories

ge.com

Individuals qualified to service their own appliances can have parts or accessories sent directly to their homes (VISA, MasterCard and Discover cards are accepted). Order on-line today, 24 hours every day or by phone at 800.626.2002 during normal business hours.

Instructions contained in this manual cover procedures to be performed by any user. Other servicing generally should be referred to qualified service personnel. Caution must be exercised, since improper servicing may cause unsafe operation.



Contact Us

ge.com

If you are not satisfied with the service you receive from GE, contact us on our Website with all the details including your phone number, or write to: General Manager, Customer Relations
GE Appliances, Appliance Park
Louisville, KY 40225



Register Your Appliance

ge.com

Register your new appliance on-line—at your convenience! Timely product registration will allow for enhanced communication and prompt service under the terms of your warranty, should the need arise. You may also mail in the preprinted registration card included in the packing material, or detach and use the form in the Owner's Manual.