

STAIR-NOSING PROFILES



INNOVATIVE SOLUTIONS FOR CERAMIC AND STONE TILE

FINISHING, EDGE PROTECTION, VISUAL ENHANCEMENT, AND SLIP-RESISTANCE

Ceramic and stone tiles are brittle materials whose exposed edges are prone to cracking and chipping when left unprotected. Tiled stair edges that do not utilize appropriate trim pieces are left vulnerable to chipping and breaking and can create a slip hazard, especially in exterior applications. Schluter® stair-nosing profiles protect exposed tile edges and improve safety on tiled stairways by providing slip-resistant wear surfaces and increased visibility in both residential and commercial applications.

Application and Function

Residential Applications

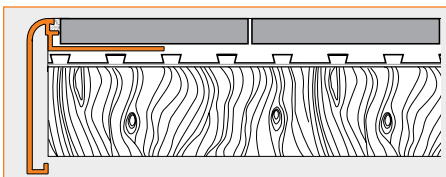

2.8 Schluter®-RONDEC-STEP is a finishing and edging profile for ceramic tile and natural stone installations on stairs and countertops. The profile features a trapezoid-perforated anchoring leg, which is secured in the mortar bond coat beneath the tile. The top of the profile features a symmetrically rounded edge with 1/4" (6 mm) radius, which matches the RONDEC profile, while the vertical leg of the profile hides the exposed edge of the sub-assembly. In addition, the profile effectively protects tiles in the edge area from mechanical and impact stresses. The integrated joint spacer establishes a defined joint cavity between the tile and the profile. RONDEC-STEP is suitable for residential applications, e.g., stairs not exposed to heavy traffic, and countertops. RONDEC-STEP is available in two vertical leg lengths, 1-1/2" (39 mm) and 2-1/4" (57 mm), to cover the

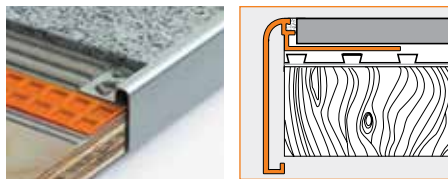

2.8 Schluter®-RONDEC-STEP

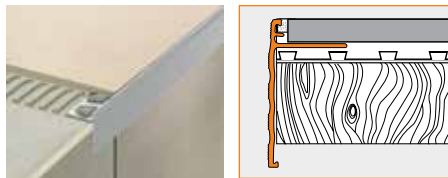

2.11 Schluter®-SCHIENE-STEP

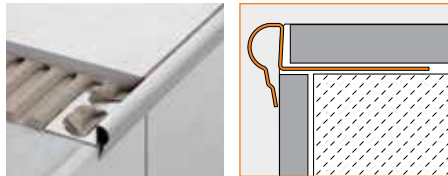

3.4 Schluter®-TREP-FL

edge of the sub-assembly. The profile is available in anodized aluminum with various finishes to allow for decorative design and interesting accents. Matching corners are available.

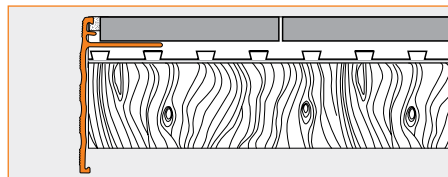

2.11 Schluter®-SCHIENE-STEP is a finishing and edging profile for ceramic tile and natural stone installations on countertops, stairs, and tile over tile applications on walls. The profile features a trapezoid-perforated anchoring leg, which is secured in the mortar bond coat beneath the tile. The top of the profile features a vertical wall section that finishes and

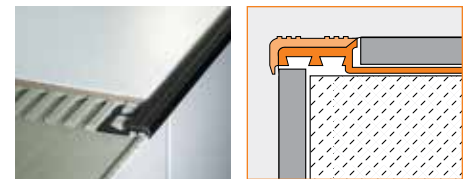

3.1 Schluter®-TREP-T

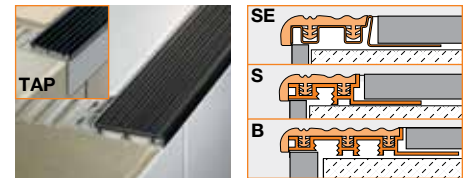

3.2 Schluter®-TREP-SE/-S/-B

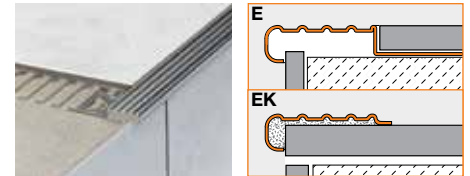

3.3 Schluter®-TREP-E/-EK

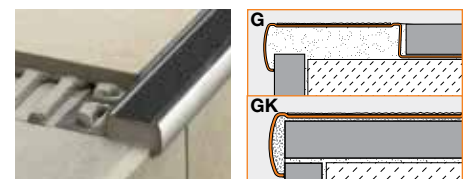

3.5 Schluter®-TREP-G/-GK

protects the tile from damage, while the vertical leg covers the edge of the sub-assembly, top of the riser, or existing wall tile edge.

SCHIENE-STEP is available in anodized aluminum and brushed stainless steel versions, which have different shapes and intended uses. The stainless steel version is available in three vertical leg lengths: 1-1/2" (39 mm) for countertops, 1-3/16" (30 mm) for stairs, and 7/16" (11 mm) for tile over tile applications. Matching inside and outside corners and connectors are



available, depending on the vertical leg length. The anodized aluminum version is intended for residential stair applications (stairs not exposed to heavy traffic). It is available in two vertical leg lengths, 1-3/16" (30 mm) and 1-1/2" (39 mm), to cover the edge of the sub-assembly. The integrated joint spacer establishes a defined joint cavity between the tile and the profile. Accessories are not available for the anodized aluminum version.

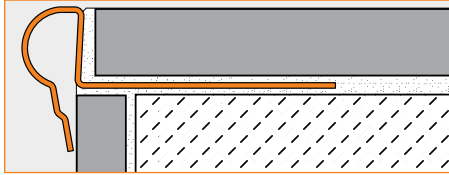

3.4 Schluter®-TREP-FL is a decorative stainless steel stair-nosing profile with a protruding rounded edge that can be integrated into stairs covered with ceramic tile or natural stone. The profile protects the front edge of stairs and adds a high degree of safety by improving the visibility of the stair edges. TREP-FL is suitable for residential applications, e.g., stairs not exposed to heavy traffic. Matching end caps are available.

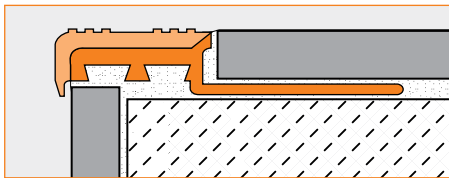

3.1 Schluter®-TREP-T is designed to protect tiled stair edges and provide an easily visible, slip-resistant wear surface for durable, safe, and visually appealing stair-nosing design. The profile features a trapezoid-perforated anchoring leg made of rigid PVC, which is secured in the mortar bond coat beneath the tile and supports a soft, slip-resistant PVC wear surface. The slip-resistant tread is designed to increase visibility, adding a high degree of safety to stairs. TREP-T is intended for residential use or use in areas with similar traffic. The profile is permanently installed in the covering and cannot be replaced when damaged by excessive wear (Note: TREP-SE/-S/-B offer replaceable inserts). TREP-T has a consistent, uniform color at the wear surface. Matching end caps are available.

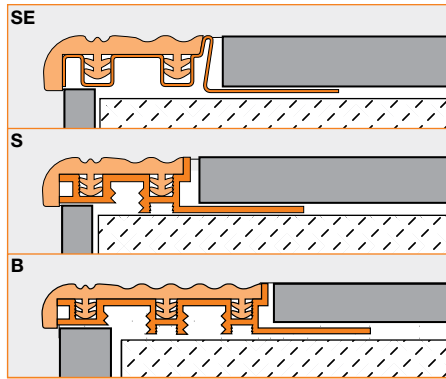

3.2 Schluter®-TREP-SE/-S/-B are designed to protect tiled stair edges and provide an easily visible, slip-resistant wear surface for durable, safe, and visually appealing stair-nosing design. They are suitable for use in areas subjected to heavy foot-traffic, such as offices or public buildings. The profiles feature a trapezoid-perforated anchoring leg made of stainless steel (TREP-SE) or aluminum (TREP-S and TREP-B), which is secured in the mortar bond coat beneath the tile and supports a slip-resistant thermoplastic rubber wear surface. The tread surface of TREP-SE/-S/-B is available in a variety of colors and can be replaced in case of damage or wear. The tread surface meets or exceeds the static coefficient of friction recommendation in the Americans with Disabilities Act (ADA), for use in applications where the risk of slipping exists (United States Testing Company, test method ASTM C 1028, .6 wet, .8 dry). TREP-B features a 2-1/8" (52 mm)-wide wear surface, allowing the designer to easily produce stairs with the first and last steps marked by a 2" (50 mm)-wide strip in a contrasting color to increase visibility and safety. The leading edges of TREP-S/-SE/-B have a 5/16" (8 mm) radius. Matching end caps are available.

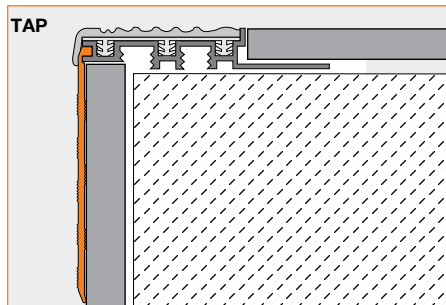

3.1 Schluter®-TREP-TAP is an anodized aluminum cover profile that integrates with the TREP-S/-B stair-nosing profiles to conceal the top of the riser.

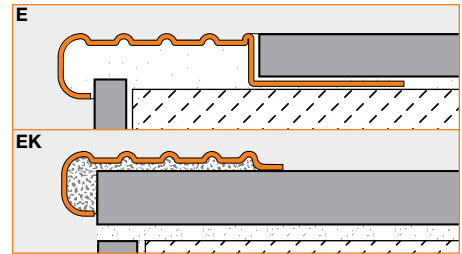

3.3 Schluter®-TREP-E is designed to protect tiled stair edges and provide an easily visible, slip-resistant wear surface for durable, safe, and visually appealing stair-nosing design. The profile is made of attractive and durable stainless steel, making it particularly suited for areas subjected to heavy foot traffic, such as offices or public buildings. The profile can be integrated into stairs covered with ceramic tile or natural stone, as well as into a screed or a surface coating that is a minimum 3/32" (2 mm) thick via the trapezoid-perforated anchoring leg. When integrated into screed layers, the anchoring leg of the profile must be covered with at least 9/16" (15 mm) of mortar. **Schluter®-TREP-EK** is a variant without an anchoring leg. TREP-EK is adhered to existing steps, e.g., for retrofitting over damaged edges, eliminating the need to replace the entire step. The TREP-E wear surface meets or exceeds the coefficient of friction recommendation in the Americans with Disabilities Act (ADA), for use in applications where the risk of slipping exists (Tile Council of North America (TCNA), test method ASTM C 1028, .66 wet or dry). Matching end caps are available.

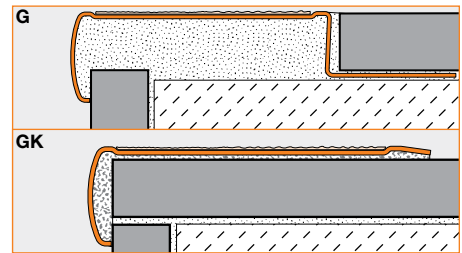

3.5 Schluter®-TREP-G is designed to protect tiled stair edges and provide an easily visible, slip-resistant wear surface for durable, safe, and visually appealing stair-nosing design. The profile is made of attractive and durable stainless steel with a special slip-resistant tread, making it particularly suited for areas subjected to heavy foot traffic, such as offices or public buildings. The surface features a self-adhesive, slip-resistant tread with an embedded mineral grain coating. The treads are available in a variety of colors and can be replaced in case of damage or wear. The profile can be integrated



into stairs covered with ceramic tile or natural stone, as well as into a screed or surface coating. **Schluter®-TREP-GK** is a variant of the profile without an anchoring leg. TREP-GK is adhered to existing steps, e.g., for retrofitting over damaged edges, eliminating the need to replace the entire step. TREP-G is available in 1-3/16" (30 mm) and 2-5/32" (55 mm) widths, while TREP-GK is available in 1-11/32" (34 mm) and 2-21/64" (59 mm) widths. Matching end caps are available.

Material Properties and Areas of Application

Schluter® stair-nosing profiles are resistant to most chemicals encountered in tiled environments. In special cases, the suitability of a proposed type of material must be verified based on the anticipated chemical, mechanical, and/or other stresses. Exceptions and special considerations are listed below.

Stainless steel profiles are roll-formed, resulting in a slightly different contour from those made of extruded brass or aluminum. Stainless steel can sustain high mechanical stresses and is particularly well suited for applications requiring resistance against chemicals and acids; for example in the food industry, breweries, dairies, commercial kitchens, and hospitals, as well as in residential applications. Typically, the profiles are formed using stainless steel 304 (1.4031 = V2A). For more severe chemical exposure, such as de-icing salts and chemicals used in swimming pools, we recommend the use of stainless steel 316 L (1.4404 = V4A), which offers even higher corrosion resistance than the 304. Even stainless steel cannot withstand all chemical exposures, such as hydrochloric acid, hydrofluoric acid or certain chlorine, chloride, and brine concentrations.

Aluminum profiles must be tested to verify their suitability if chemical stresses are anticipated. Cementitious materials, in conjunction with moisture, become alkaline. Since aluminum is sensitive to alkaline substances, exposure to the alkali (depending on the concentration and duration of exposure) may result in corrosion (aluminum hydroxide formation). Therefore, it is important to remove mortar or grout residue from visible surfaces. In addition, ensure that the profile is solidly embedded in the setting material and that all cavities are filled to prevent the collection of alkaline water.

Anodized aluminum profiles feature an anodized layer that retains a uniform appearance during normal use. The surface, however, is susceptible to scratching and wear and may be damaged by grout or setting material. Therefore, these materials

must be removed immediately. Otherwise, the description regarding aluminum applies.

Thermoplastic rubber inserts are highly resistant to chemicals and can withstand chemical stresses typically encountered in tiled environments.

PVC treads are UV-resistant, though not permanently color-stable, in exterior applications.

Mineral grain coated treads are resistant to heavy mechanical stresses and can withstand chemical stresses typically encountered in tiled environments. They can be used for interior and exterior applications, except for the transparent tread that has limited UV resistance and is intended for interior use only.

Installation

RONDEC-STEP and SCHIENE-STEP

1. Select profile according to tile thickness and sub-assembly thickness.
2. Using a notched trowel, apply thin-set mortar over the area where the trapezoid-perforated anchoring leg will be placed.
3. Press the perforated anchoring leg of profile into the thin-set mortar and align.
4. Trowel additional thin-set mortar over the perforated anchoring leg to ensure full coverage and support of the tile edges.
5. Solidly embed the tiles so that the tiled surface is flush with the top of the profile; the profile should not be higher than the tiled surface, but rather up to approximately 1/32" (1 mm) lower.
6. Set the tile to the integrated joint spacer, which ensures a uniform joint of 1/16" – 1/8" (1.5 – 3 mm).
7. Fill the joint completely with grout or setting material.
8. Work with materials and tools that will not scratch or damage sensitive surfaces. Setting materials must be removed immediately, especially from aluminum.

Note: Matching corners are available for RONDEC-STEP. Matching corners and connectors are available for the stainless steel version of SCHIENE-STEP only, depending on the vertical leg length.

RONDEC-STEP corners are held in place with thin-set mortar. Fill the ends of the profile with thin-set mortar prior to inserting the accessories.

SCHIENE-STEP corners and connectors are installed using KERDI-FIX, silicone, or similar adhesive. Prior to application, any contact-inhibiting substances (e.g., grease, etc.) must be removed. The accessories should overlap the profiles by at least 3/8" (10 mm). The accessories must be slid on the profiles during profiles installation (cannot be placed

over the profiles after installation).

TREP-FL, TREP-T, TREP-SE/-S/-B, TREP-E and TREP-G

1. Select profile size according to tile thickness.
2. Install riser tile flush with the stair tread surface.
3. Using a notched trowel, apply thin-set mortar along edge area above riser.
4. Fill cavities on the underside of the profile with thin-set mortar (Exception: does not apply to TREP-FL).
5. Press the trapezoid-perforated anchoring leg of the profile into the thin-set mortar, making sure the front edge of the support section is aligned flush with the riser tile (Exception: TREP-E, TREP-FL and TREP-G are installed such that the front edge of the profile overlaps the riser tile). Full coverage must be obtained at the edge area to ensure support of the profile.
6. Trowel additional thin-set mortar over the anchoring leg and the stair tread surface to ensure full coverage and support of the tile edges.
7. Solidly embed the tread tiles so that the tiled surface is flush with the top of the profile.
8. A joint of approx. 1/16" - 1/8" (1.5 - 3 mm) should be left between the tile and the profile.
9. Fill joint completely with grout or setting material.

Notes: When using TREP-TAP, apply Schluter®-KERDI-FIX or similar adhesive to the riser and insert the cover profile in the support section of TREP-S/-B prior to installing the stair-nosing profile. TREP-TAP should not be used where it can extend past the bottom of the riser.

TREP-EK and TREP-GK

1. Clean the stair nosings and repair damaged areas if applicable.
2. Clean or degrease the underside of the profile.
3. Adhere the profile by fully embedding it into a suitable adhesive (e.g., epoxy resin or KERDI-FIX, depending on the substrate).

Note: The upper profile edge of TREP-EK is approximately 3/32" (2.5 mm) higher than the stair covering, while the upper profile edge of TREP-GK is approximately 1/16" (1.5 mm) higher than the stair covering.

Maintenance

Schluter® stair-nosing profiles require no special maintenance or care and are resistant to mold and fungi. Clean profiles using common household cleaning agents. **Stainless steel** surfaces exposed to the environment or aggressive substances should be cleaned periodically using a mild household cleaner. Regular cleaning

maintains the neat appearance of stainless steel and reduces the risk of corrosion. All cleaning agents must be free of hydrochloric acid, hydrofluoric acid, and chlorides. Stainless steel surfaces develop a sheen when treated with a chrome-polishing agent. Oxidation films on **aluminum** may be removed with a conventional polishing agent, but will form again.

In the case of **anodized aluminum**, do not use abrasive or strong alkaline cleaning agents.

The treads of TREP-SE/-S/-B/-G/-GK can be replaced in case of damage or wear.

Product Item Numbers

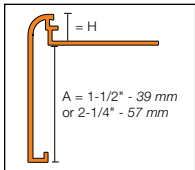
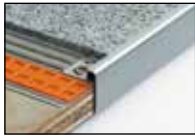

2.8 Schluter®-RONDEC-STEP

H = mm - in.	Item No.					
	Satin anodized aluminum (AE)	Brushed chrome anodized aluminum (ACGB)	Satin nickel anodized aluminum (AT)	Brushed nickel anodized aluminum (ATGB)	Satin copper/bronze anodized aluminum (AK)	Brushed copper/bronze anodized aluminum (AKGB)
A: 39 mm - 1-1/2"						
8 - 5/16	RS 80 AE 39	RS 80 ACGB 39	RS 80 AT 39	RS 80 ATGB 39	RS 80 AK 39	RS 80 AKGB 39
10 - 3/8	RS 100 AE 39	RS 100 ACGB 39	RS 100 AT 39	RS 100 ATGB 39	RS 100 AK 39	RS 100 AKGB 39
12.5 - 1/2	RS 125 AE 39	RS 125 ACGB 39	RS 125 AT 39	RS 125 ATGB 39	RS 125 AK 39	RS 125 AKGB 39
A: 57 mm - 2-1/4"						
8 - 5/16	RS 80 AE 57	RS 80 ACGB 57	RS 80 AT 57	-	RS 80 AK 57	RS 80 AKGB 57
10 - 3/8	RS 100 AE 57	RS 100 ACGB 57	RS 100 AT 57	-	RS 100 AK 57	RS 100 AKGB 57
12.5 - 1/2	RS 125 AE 57	RS 125 ACGB 57	RS 125 AT 57	-	RS 125 AK 57	RS 125 AKGB 57

H = mm - in.	Item No.		
	Satin brass anodized aluminum (AM)	Brushed brass anodized aluminum (AMGB)	Brushed antique bronze anodized aluminum (ABGB)
A: 39 mm - 1-1/2"			
8 - 5/16	-	RS 80 AMGB 39	RS 80 ABGB 39
10 - 3/8	-	RS 100 AMGB 39	RS 100 ABGB 39
12.5 - 1/2	-	RS 125 AMGB 39	RS 125 ABGB 39
A: 57 mm - 2-1/4"			
8 - 5/16	RS 80 AM 57	RS 80 AMGB 57	-
10 - 3/8	RS 100 AM 57	RS 100 AMGB 57	-
12.5 - 1/2	RS 125 AM 57	RS 125 AMGB 57	-

Length supplied: 8' 2-1/2" — 2.50 m

Accessories	Item No.
Outside corner, 90°	E 90 <i>profile item number*</i>
Outside corner, 135°	E 135 <i>profile item number*</i>
Inside corner, 90°	I 90 <i>profile item number*</i>
Inside corner, 135°	I 135 <i>profile item number*</i>



How to order corners:

*To complete the item number for corners, add the corresponding **profile item number** (e.g., E 90 **RS 80 ACGB 39**).

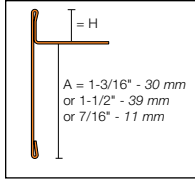

2.8 Schluter®-SCHIENE-STEP

H = mm - in.	Item No.				
	Brushed Stainless Steel 304 (1.4301 = V2A) (EB)				
	Profile	Inside corner, 90°	Inside corner, 135°	Outside corner, 90° and End Cap	Outside corner, 135°
A: 39 mm - 1-1/2"					
6 - 1/4	SS 60 EB 39	I90 / SS 60 EB 39	I135 / SS 60 EB 39	E90 / SS 60 EB 39	E135 / SS 60 EB 39
9 - 11/32	SS 90 EB 39	I90 / SS 90 EB 39	I135 / SS 90 EB 39	E90 / SS 90 EB 39	E135 / SS 90 EB 39
11 - 7/16	SS 110 EB 39	I90 / SS 110 EB 39	I135 / SS 110 EB 39	E90 / SS 110 EB 39	E135 / SS 110 EB 39
12.5 - 1/2	SS 125 EB 39	I90 / SS 125 EB 39	I135 / SS 125 EB 39	E90 / SS 125 EB 39	E135 / SS 125 EB 39
A: 30 mm - 1-3/16"					
9 - 11/32	SS 90 EB 30	-	-	E90 / SS 90 EB 30	-
11 - 7/16	SS 110 EB 30	-	-	E90 / SS 110 EB 30	-
12.5 - 1/2	SS 125 EB 30	-	-	E90 / SS 125 EB 30	-
A: 11 mm - 7/16"					
6 - 1/4	SS 60 EB 11				
12.5 - 1/2	SS 125 EB 11				

H = mm - in.	Item No.	
	Brushed Stainless Steel 304 (1.4301 = V2A) (EB)	
	Connector	
A: 39 mm - 1-1/2"		
9 - 11/32	V / SS 90 EB 39	
11 - 7/16	V / SS 110 EB 39	
12.5 - 1/2	V / SS 125 EB 39	
A: 30 mm - 1-3/16"		
6 - 1/4	V / SS 60 EB 30	
9 - 11/32	V / SS 90 EB 30	
11 - 7/16	V / SS 110 EB 30	
12.5 - 1/2	V / SS 125 EB 30	
A: 11 mm - 7/16"		
6 - 1/4	V / SS 60 EB 11	
12.5 - 1/2	V / SS 125 EB 11	

Length supplied: 8' 2-1/2" – 2.50 m

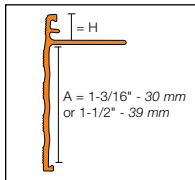

2.8 Schluter®-SCHIENE-STEP

H = mm - in.	Item No.	
	Satin anodized aluminum (AE)	Satin nickel anodized aluminum (AT)
A: 30 mm - 1-3/16"		
8 - 5/16	SS 80 AE 30	SS 80 AT 30
10 - 3/8	SS 100 AE 30	SS 100 AT 30
12.5 - 1/2	SS 125 AE 30	SS 125 AT 30
15 - 9/16	SS 150 AE 30	SS 150 AT 30
A: 39 mm - 1-1/2"		
8 - 5/16	SS 80 AE 39	SS 80 AT 39
10 - 3/8	SS 100 AE 39	SS 100 AT 39
12.5 - 1/2	SS 125 AE 39	SS 125 AT 39
15 - 9/16	SS 150 AE 39	SS 150 AT 39

Length supplied: 8' 2-1/2" – 2.50 m

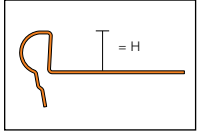

3.4 Schluter®-TREP-FL

H = mm - in.	Item No.	
	Stainless steel 304 (1.4301 = V2A) (E)	Brushed stainless steel 304 (1.4301 = V2A) (EB)
Length supplied: 8' 2-1/2" – 2.5 m		
9 - 11/32	FL 90 E	FL 90 EB
11 - 7/16	FL 110 E	FL 110 EB
12.5 - 1/2	FL 125 E	FL 125 EB
Length supplied: 4' 11" – 1.5 m		
9 - 11/32	FL 90 E / 150	FL 90 EB / 150
11 - 7/16	FL 110 E / 150	FL 110 EB / 150
12.5 - 1/2	FL 125 E / 150	FL 125 EB / 150

Accessories

Accessories	Item No.
End cap	E/ FLEB

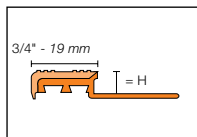

3.1 Schluter®-TREP-T

H = mm - in.	Item No.
8 - 5/16	T <i>color*</i> 8
11 - 7/16	T <i>color*</i> 11

Length supplied: 8' 2-1/2" – 2.5 m

Accessories	Item No.
End cap	EKT / <i>color*</i>



*Color Codes (-T)



To complete the item number, add the *color* code (e.g., T **HB** 8).

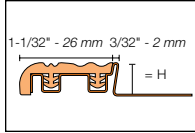

Note: Radius of leading edge = 5/16" - 8 mm.

3.2 Schluter®-TREP-SE

H = mm - in.	Item No.	
	Stainless steel support with thermoplastic rubber insert	Stainless steel support section 304 (1.4301 = V2A)
Length supplied: 8' 2-1/2" - 2.5 m		
8 - 5/16	<i>color*</i> 8 SE	TES 8
10 - 3/8	<i>color*</i> 10 SE	TES 10
12.5 - 1/2	<i>color*</i> 12 SE	TES 12
Length supplied: 4' 11" - 1.5 m		
8 - 5/16	<i>color*</i> 8 SE / 150	TES 8 / 150
10 - 3/8	<i>color*</i> 10 SE / 150	TES 10 / 150
12.5 - 1/2	<i>color*</i> 12 SE / 150	TES 12 / 150
Accessories	Item No.	
End cap	E 26 / <i>color*</i>	



Item No.

Item No.
Replacement thermoplastic rubber insert
Length supplied: 8' 2-1/2" - 2.5 m
PE 26 / <i>color*</i>
Length supplied: 10' - 3 m
PE 26 / <i>color*</i> / 300

*Color Codes

CG Yellow
 G Grey
 HB Light beige
 NB Nut brown
 GS Black

* To complete the item number, add the **color** code (e.g., **G** 10 SE).

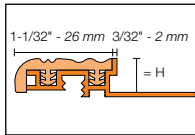

Note: Radius of leading edge = 5/16" - 8 mm.

3.2 Schluter®-TREP-S

H = mm - in.	Item No.	
	Aluminum support with thermoplastic rubber insert	Aluminum support section
Length supplied: 8' 2-1/2" - 2.5 m		
8 - 5/16	<i>color*</i> 8 S	TAS 8
10 - 3/8	<i>color*</i> 10 S	TAS 10
12.5 - 1/2	<i>color*</i> 12 S	TAS 12
Length supplied: 4' 11" - 1.5 m		
8 - 5/16	<i>color*</i> 8 S / 150	TAS 8 / 150
10 - 3/8	<i>color*</i> 10 S / 150	TAS 10 / 150
12.5 - 1/2	<i>color*</i> 12 S / 150	TAS 12 / 150
Accessories	Item No.	
End cap	E 26 / <i>color*</i>	



Item No.

Item No.
Replacement thermoplastic rubber insert
Length supplied: 8' 2-1/2" - 2.5 m
PEA 26 / <i>color*</i>
Length supplied: 10' - 3 m
PEA 26 / <i>color*</i> / 300
Length supplied: 50' - 15 m
PEA 26 / <i>color*</i> / 50

*Color Codes

CG Yellow
 G Grey
 HB Light beige
 NB Nut brown
 GS Black

* To complete the item number, add the **color** code (e.g., **G** 10 S).

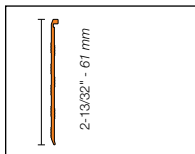
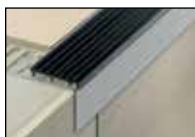

3.2 Schluter®-TREP-TAP

Item No.
Satin anodized aluminum (AE)
Length supplied: 8' 2-1/2" - 2.5 m
TAPR 61 AE
Length supplied: 4' 11" - 1.5 m
TAPR 61 AE / 150

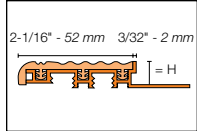
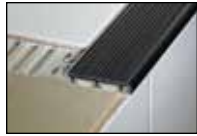

Note: Radius of leading edge = 5/16" - 8 mm.

3.2 Schluter®-TREP-B

H = mm - in.	Item No.	
	Aluminum support with thermoplastic rubber insert	Aluminum support section
Length supplied: 8' 2-1/2" – 2.5 m		
8 - 5/16	<i>color*</i> 8 B	TAB 8
10 - 3/8	<i>color*</i> 10 B	TAB 10
12.5 - 1/2	<i>color*</i> 12 B	TAB 12
15 - 9/16	<i>color*</i> 15 B	TAB 15
25 - 1	<i>color*</i> 25 B	TAB 25
Length supplied: 4' 11" – 1.5 m		
8 - 5/16	<i>color*</i> 8 B / 150	TAB 8 / 150
10 - 3/8	<i>color*</i> 10 B / 150	TAB 10 / 150
12.5 - 1/2	<i>color*</i> 12 B / 150	TAB 12 / 150
15 - 9/16	<i>color*</i> 15 B / 150	TAB 15 / 150
25 - 1	<i>color*</i> 25 B / 150	TAB 25 / 150

Accessories	Item No.
End cap	E 52 / <i>color*</i>



Replacement thermoplastic rubber insert

Item No.
Length supplied: 8' 2-1/2" – 2.5 m
PEA 52 / <i>color*</i>
Length supplied: 10' – 3 m
PEA 52 / <i>color*</i> / 300
Length supplied: 50' – 15 m
PEA 52 / <i>color*</i> / 50

*Color Codes



* To complete the item number, add the **color** code (e.g., **G** 10 B).

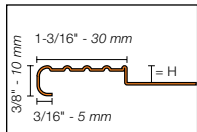

3.3 Schluter®-TREP-E

H = mm - in.	Item No.	
	Stainless steel 304 (1.4301 = V2A)	
Length supplied: 8' 2-1/2" – 2.5 m		
2 - 3/32	TE 20	
5 - 3/16	TE 50	
8 - 5/16	TE 80	
11 - 7/16	TE 110	
16 - 5/8	TE 160	
25 - 1	TE 250	
Length supplied: 4' 11" – 1.5 m		
2 - 3/32	TE 20 / 150	
5 - 3/16	TE 50 / 150	
8 - 5/16	TE 80 / 150	
11 - 7/16	TE 110 / 150	
16 - 5/8	TE 160 / 150	
25 - 1	TE 250 / 150	

Accessories	Item No.
End cap	E/TE

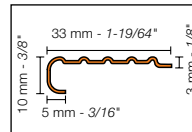

3.3 Schluter®-TREP-EK

Item No.
Stainless steel 304 (1.4301 = V2A)
Length supplied: 8' 2-1/2" – 2.5 m
TEK
Length supplied: 4' 11" – 1.5 m
TEK / 150

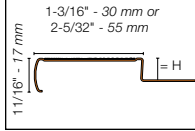

3.3 Schluter®-TREP-G-S

H = mm - in.	Item No.
	Brushed stainless steel support with non-slip tread (30 mm - 1-3/16")

Length supplied: 8' 2-1/2" - 2.5 m

9 - 11/32	GS EB 90 + color*
11 - 7/16	GS EB 110 + color*
13 - 33/64	GS EB 130 + color*
15 - 9/16	GS EB 150 + color*

Length supplied: 4' 11" - 1.5 m

9 - 11/32	GS EB 90 + color* / 150
11 - 7/16	GS EB 110 + color* / 150
13 - 33/64	GS EB 130 + color* / 150
15 - 9/16	GS EB 150 + color* / 150

Item No.

Replacement tread

Length supplied: 60' 1-1/32" - 18.3 m

GS KB 183 / color*

Accessories	Item No.
End cap	E/GS EB



*Color Codes



To complete the item number, add the color* code (e.g., GS EB 90 GS).

3.3 Schluter®-TREP-G-B

H = mm - in.	Item No.
	Brushed Stainless steel support with non-slip tread (55 mm - 2-5/32")

Length supplied: 8' 2-1/2" - 2.5 m

9 - 11/32	GB EB 90 + color*
11 - 7/16	GB EB 110 + color*
13 - 33/64	GB EB 130 + color*
15 - 9/16	GB EB 150 + color*

Length supplied: 4' 11" - 1.5 m

9 - 11/32	GB EB 90 + color* / 150
11 - 7/16	GB EB 110 + color* / 150
13 - 33/64	GB EB 130 + color* / 150
15 - 9/16	GB EB 150 + color* / 150

Item No.

Replacement tread

Length supplied: 60' 1-1/32" - 18.3 m

GB KB 183 / color*

Accessories	Item No.
End cap	E/GB EB



*Color Codes



To complete the item number, add the color* code (e.g., GB EB 90 GS).

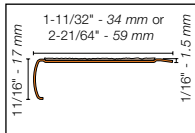

3.3 Schluter®-TREP-GK-S

Item No.

Brushed stainless steel support with non-slip tread (34 mm - 1-11/32")

Length supplied: 8' 2-1/2" - 2.5 m

GS EBK + color*

Length supplied: 4' 11" - 1.5 m

GS EBK + color* / 150

Item No.

Replacement tread

Length supplied: 60' 1/32" - 18.3 m

GS KB 183 + color*

3.3 Schluter®-TREP-GK-B

Item No.

Brushed stainless steel support with non-slip tread (59 mm - 2-21/64")

Length supplied: 8' 2-1/2" - 2.5 m

GB EBK + color*

Length supplied: 4' 11" - 1.5 m

GB EBK + color* / 150

Item No.

Replacement tread

Length supplied: 60' 1/32" - 18.3 m

GB KB 183 + color*



Schluter®-Systems Stair-Nosing Profiles 5-Year Limited Warranty

COVERAGE AND CONDITIONS: Subject to the conditions and limitations as stated hereinafter, **Schluter-Systems*** warrants that **Schluter®-Systems Stair-Nosing Profiles** (the "Products")** will be free from manufacturing defects for a period of five (5) years from the date of purchase and only when the Products are used and installed in accordance with the terms and conditions of the Schluter®-Systems Stair-Nosing Profiles Technical Data Sheet and industry standard guidelines that are not in conflict with the Data Sheet in effect at the time of installation. It is the responsibility of the owner/builder/installer to ensure the suitability of all building materials and all associated building materials for the owner's intended use. Visual defects or nonconformities apparent prior to installation are not covered by this warranty. Further, this warranty does not cover normal wear and tear or other damage (e.g., scratches, discoloration, fading, etc.) caused by impacts or accidents. Consumable parts of Products are warranted, at the time of sale, only against defects in workmanship or materials that prevent their use. Consumable parts are goods reasonably expected to be used up or damaged during normal use, including but not limited to replaceable stair-nosings. It is recommended that the owner consult an experienced and professional installer.

RESOLUTION: If the Products fail to meet this warranty, then the owner's exclusive remedy and the sole obligation of Schluter-Systems, at its election, shall be to a) reinstall or replace the failed portion of the tile assembly or b) pay an amount not to exceed the original square foot cost of the installation of the tile assembly verified to be defective. Tile assembly is defined to include all Schluter®-Systems Stair-Nosing Profiles, non-reusable tile surfaces, and the appropriate setting and grouting materials. Further, due to conditions beyond the control of Schluter-Systems (e.g., color and shade availability, discontinuation, normal wear and tear), Schluter-Systems cannot guarantee or warrant an exact match to the specific tile, stone, or other flooring materials used in the installation. In such events, substantially similar materials may be substituted.

DISCLAIMER: THERE ARE NO WARRANTIES BEYOND THIS EXPRESSED WARRANTY AS STATED ABOVE. ALL OTHER WARRANTIES, REPRESENTATIONS OR CONDITIONS, EXPRESSED OR IMPLIED, ARE DISCLAIMED AND EXCLUDED, INCLUDING WARRANTIES, REPRESENTATIONS OR CONDITIONS OF **MERCHANTABILITY** OR FITNESS FOR A PARTICULAR PURPOSE ARISING BY STATUTE OR OTHERWISE BY LAW OR FROM A COURSE OF DEALING OR USAGE OF TRADE. SCHLUTER-SYSTEMS EXCLUDES AND IN NO EVENT SHALL HAVE ANY LIABILITY FOR LOST PROFITS OR ANY OTHER INDIRECT, SPECIAL, INCIDENTAL, PUNITIVE, EXEMPLARY, OR CONSEQUENTIAL DAMAGES, ARISING OUT OF OR OTHERWISE CONNECTED TO FAILURE OF THE PRODUCTS OR FLOORING SYSTEM OF WHICH THEY ARE PART, NOR MISUSE OF THE PRODUCTS OR FLOORING SYSTEM, REGARDLESS OF ANY STRICT LIABILITY, ACTIVE OR PASSIVE NEGLIGENCE OF SCHLUTER-SYSTEMS, AND REGARDLESS OF THE LEGAL THEORY (CONTRACT OR TORT OR EXTRA-CONTRACTUAL OR OTHER), NOR FROM ACTS OF WAR, TERRORISM, FAULTY AND NEGLIGENT PENETRATION OF THE SYSTEM, FIRES, EXPLOSIONS, ACTS OF GOD, INTENTIONAL ACTS OF DESTRUCTION OR ANY LOSSES DUE TO STRUCTURAL FAILURE OR OTHER CAUSES UNRELATED TO THE PRODUCTS OR DELAYS, OR ANY OTHER INCIDENTAL OR CONSEQUENTIAL DAMAGES. THIS WARRANTY IS GIVEN IN LIEU OF ANY OTHER WARRANTY EXPRESSED OR IMPLIED. THE REMEDIES CONTAINED HEREIN ARE THE ONLY REMEDIES AVAILABLE FOR BREACH OF THIS WARRANTY. THIS LIMITED WARRANTY GIVES YOU SPECIFIC LEGAL RIGHTS, SOME STATES AND PROVINCES DO NOT ALLOW DISCLAIMERS OR OTHER RESTRICTIONS OF IMPLIED WARRANTIES SO SOME OF THE ABOVE LIMITATIONS MAY NOT APPLY TO YOU.

TRANSFERABILITY: This Limited Warranty extends ONLY to the original end user (defined as original intended owner and user of the property/unit in which the installation is incorporated - herein referred to as "Owner") and is not transferable or assignable, unless approved in writing by the Technical Director or an Officer of Schluter-Systems or otherwise prohibited by specific state or provincial law.

MODIFICATIONS TO WARRANTY: No changes or modification of any terms or conditions of this warranty are allowed unless authorized by written agreement and signed by the Technical Director or an Officer of Schluter-Systems.

EFFECTIVE DATE: This warranty shall supersede and replace any and all prior oral or written warranties, agreements, or other such representations made by or on behalf of Schluter-Systems relative to the Products or the application of the Products and shall apply to any installation occurring on or after January 1, 2013.

CLAIMS ON THIS LIMITED WARRANTY: To make a claim under this Limited Warranty, the owner must provide Schluter-Systems with written notice within 30 days of any alleged defect in the Products covered by this Limited Warranty, together with date and proof of purchase of the Products, proof of the costs of the original installation and name and address of all installers, failing which this Limited Warranty shall be of no legal effect. Schluter-Systems reserves the right at its election and as a condition of this Limited Warranty to inspect the alleged failed and defective condition.

All U.S. Claims shall be sent to:

Schluter Systems L.P.
Attn: Warranty Claims Dept.
194 Pleasant Ridge Road
Plattsburgh, NY 12901-5841

All Canadian Claims shall be sent to:

Schluter Systems (Canada), Inc.
Attn: Warranty Claims Dept.
21100 chemin Ste-Marie
Ste-Anne-de-Bellevue, QC H9X 3Y8

*For the purpose of this warranty **Schluter Systems, L.P.** shall provide the warranty for all products for end users located in the United States, and **Schluter Systems (Canada) Inc.** shall provide the warranty for all products for end users located in Canada. This warranty is limited to sales of the Products made in and intended for use in the United States and Canada.

****Schluter®-Systems Stair-Nosing Profiles (the "Products"):** The Products are defined to include all Schluter®-Systems Stair-Nosing profiles referred to in the Schluter®-Systems Stair-Nosing Profiles Data Sheet.



Schluter Systems L.P. • 194 Pleasant Ridge Road, Plattsburgh, NY 12901-5841 • Tel.: 800-472-4588 • Fax: 800-477-9783
Schluter Systems (Canada) Inc. • 21100 chemin Ste-Marie, Ste-Anne-de-Bellevue, QC H9X 3Y8 • Tel.: 800-667-8746 • Fax: 877-667-2410
info@schluter.com

www.schluter.com