

Rigid 11.22" 1.5W 24 Diode Strip Light

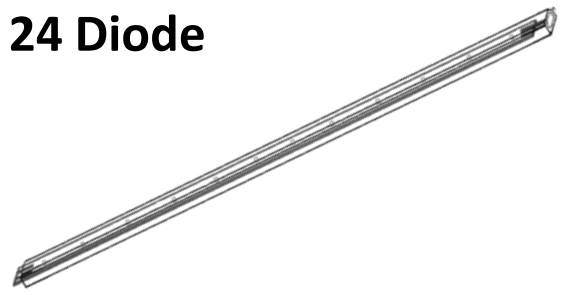

Product #: SA10121

Installation Instructions

IMPORTANT: Please read these instructions before starting installation and retain for future reference.

Required Materials:

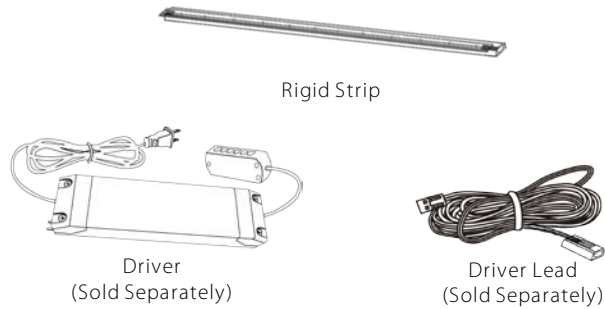

Required Tools :

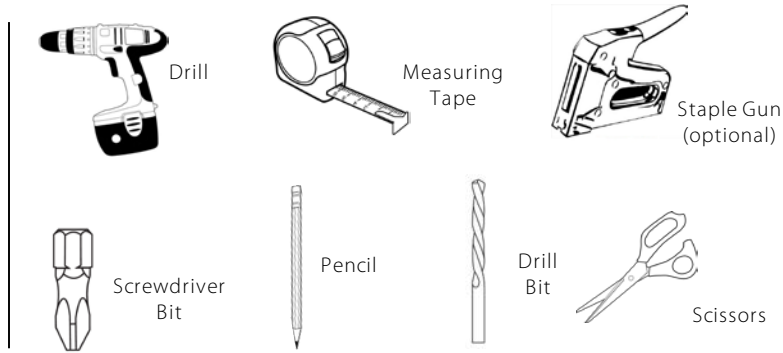

Important Safety Information

Please read these instructions carefully before attempting to install this product.

It is advisable to keep these instructions in a safe place for further reference. These products must not be modified; if any modifications are made, it may invalidate the warranty and may render the product unsafe. These LED lights operate on low voltage (12V). Do not wire the individual LED light fixtures directly to line power. This product is for indoor use only. Keep out of moisture and use only in dry rooms.

The National Electrical Code (NEC) does not permit cords to be concealed where damage to insulation may go unnoticed. To prevent fire danger, do not run cord behind walls, ceilings, soffits, or cabinets where it may be inaccessible for examination. Cords should be visually examined periodically and immediately replaced when any damage is noted.

CAUTION - To reduce the risk of fire, electric shock, or injury to persons:

- Use only insulated staples or plastic ties to secure cords
- Route and secure cords so that they will not be pinched or damaged when the cabinet is pushed to the wall
- Not intended for recessed installation in ceilings, or soffits.

Safety Instructions

- Turn off the main electrical supply for the appropriate circuit at the fuse board.
- This product is only suitable for connecting to a 12V DC power source.
- Position lights where they will not be exposed to persistent steam, splashes, etc.
- The LEDs in this fixture cannot be replaced.
- Suitable for under cabinet lighting, attached to a mounting surface such as wood or laminate.
- Failure to use surge protection in problem areas will void the warranty.
- Use only approved accessories.
- IMPORTANT:** Fixture must NOT be covered by insulation.



Installation

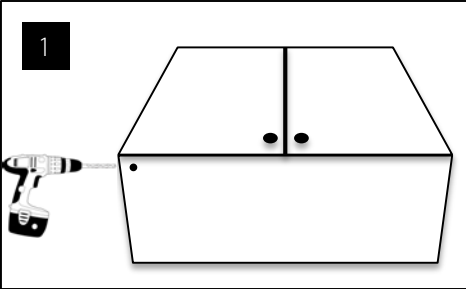

1 Drill 5/16" hole in bottom front corner.

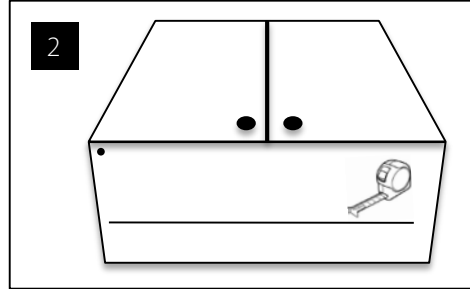

2 Determine placement (front, center, or back), use pencil to draw line. Measure line drawn.

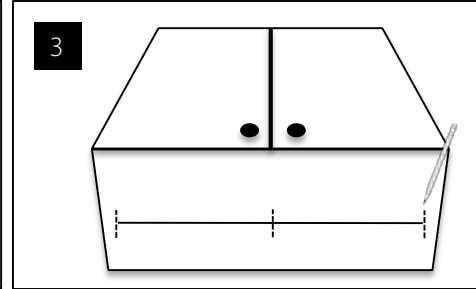

3 Determine how many strips needed and mark off where each strip will be placed.

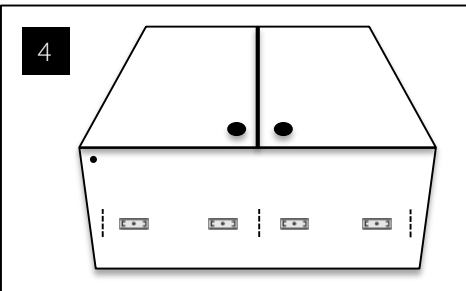

4 Install two clips for each strip with screws provided.

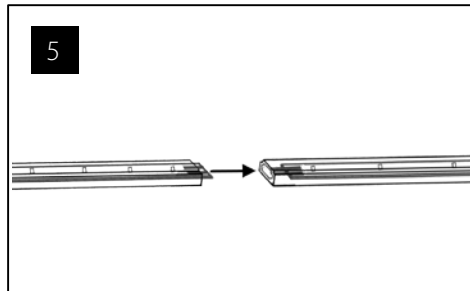

5 Plug strips together.

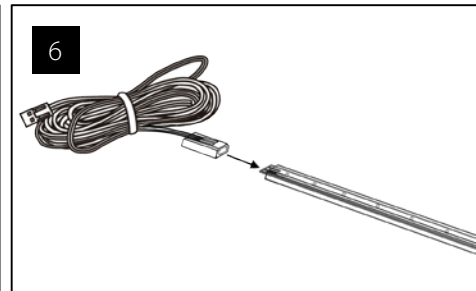

6 Attach driver lead into strip.

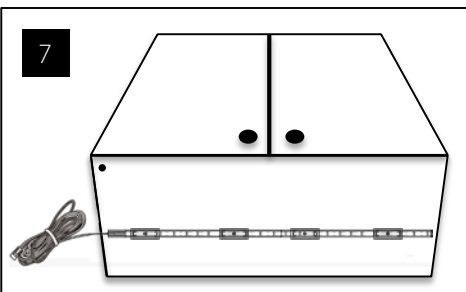

7 Snap strips into clips, driver lead on side of drilled hole.

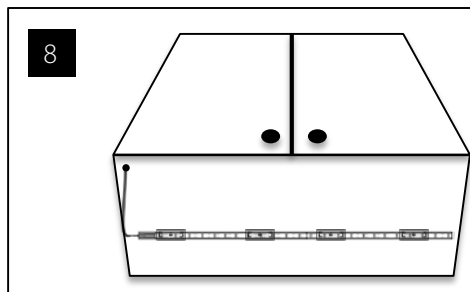

8 Feed driver lead wire through hole up along inside front corner of cabinet.

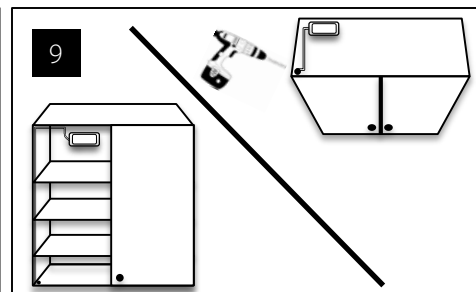

9 Feed driver lead to LED driver.

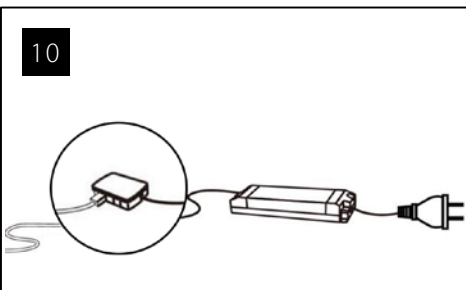

10 Connect to driver.

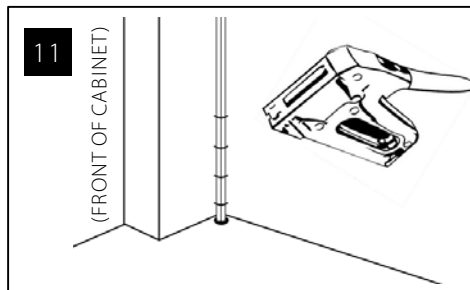

11 Staple wire in place along inside front edge of cabinet (optional).

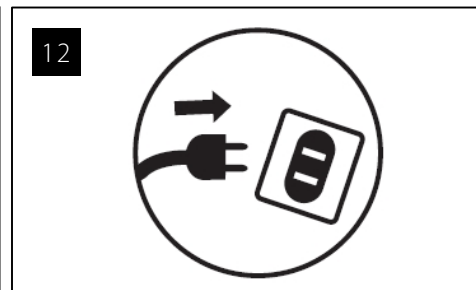

12 Connect driver to power.

Maintenance & Care

- Ensure that the power is disconnected prior to cleaning.
- To keep the finish of this product, wipe over with soft cloth periodically.
- Do not use harsh chemical solvents, it may discolor or damage the finish.

Support

Sensio America
877-501-5337

www.sensioamerica.com