

Bissell®

BigGreen Commercial™



USER'S GUIDE

MODELS BGU8000

- 2 Thank You
- 3 Safety Instructions
- 4 Product View
- 5 Assembly Instructions
- 6-7 Operating Instructions
- 8-10 Maintenance
- 11 Warranty
- 12 Customer Care

BISSELL® BigGreen Commercial™ Vacuum

We're glad you purchased a BISSELL® BigGreen Commercial™ vacuum. Everything we know about floor care went into the design and construction of this complete, high-tech commercial cleaning system.

Your BISSELL® BigGreen Commercial™ vacuum is well made, and we back it with a limited one-year commercial warranty. We also stand behind it with a knowledgeable, dedicated Customer Care department, so, should you ever have a problem, you'll receive fast, considerate assistance.

My great-grandfather invented the floor sweeper in 1876. Today, BISSELL is a global leader in the design, manufacture, and service of high quality commercial products like your BISSELL® BigGreen Commercial™ vacuum.

Thanks again, from all of us at BISSELL.

A handwritten signature in black ink that reads "Mark J. Bissell". The signature is written in a cursive, flowing style.

Mark J. Bissell
Chairman & CEO

IMPORTANT SAFETY INSTRUCTIONS

When using an electrical appliance, basic precautions should be observed, including the following:

READ ALL INSTRUCTIONS BEFORE USING YOUR BISSELL BIGGREEN COMMERCIAL VACUUM.

Always connect to a polarized outlet (left slot is wider than right). Unplug from outlet when not in use and before conducting maintenance.

⚠ WARNING: To reduce the risk of fire, electric shock, or injury:

- Do not modify the polarized plug to fit a non-polarized outlet or extension cord.
- Do not leave vacuum cleaner unattended when it is plugged in.
- Unplug from outlet when not in use and before servicing.
- Do not use outdoors or on wet surfaces.
- Do not allow children to operate vacuum cleaner or use as a toy.
- Close attention is necessary when used by or near children.
- Do not use for any purpose other than described in this User's Guide.
- Use only manufacturer's recommended attachments.
- Do not use with damaged cord or plug.
- If appliance is not working as it should, has been dropped, damaged, left outdoors, or dropped into water, have it repaired at an authorized service center.
- Do not pull or carry by cord, use cord as a handle, close a door on cord, or pull cord around sharp edges or corners. Do not run appliance over cord. Keep cord away from heated surfaces.
- Do not unplug by pulling on cord. To unplug, grasp the plug, not the cord.
- Do not handle vacuum cleaner or plug with wet hands.
- Do not put any object into openings. Do not use with any opening blocked; keep openings free of dust, lint, hair, and anything that may reduce air flow.
- Keep hair, loose clothing, fingers, and all parts of body away from openings and moving parts.
- Turn off all controls before plugging or unplugging vacuum cleaner.
- Use extra care when cleaning stairs.
- Do not pick up flammable materials (lighter fluid, gasoline, kerosene, etc.) or use in the presence of explosive liquids or vapors.
- Do not pick up toxic material (chlorine bleach, ammonia, drain cleaner, etc.).
- Do not use vacuum cleaner in an enclosed space filled with vapors given off by oil base paint, paint thinner, some moth proofing substances, flammable dust, or other explosive or toxic vapors.
- Do not pick up hard or sharp objects such as glass, nails, screws, coins, etc.

- Do not pick up anything that is burning or smoking, such as cigarettes, matches, or hot ashes.
- Do not use without filters in place.
- Use only on dry, indoor surfaces.
- Keep appliance on a level surface.
- Do not carry the vacuum cleaner while it is running.
- Do not operate cleaner in bare feet or when wearing open-toe shoes or sandals.
- Do not use without dust bag or dirt cup in place. Shake bag and empty dirt cup frequently when picking up very fine materials such as powder.

SAVE THESE INSTRUCTIONS.

THIS MODEL IS FOR COMMERCIAL USE.

GROUNDING INSTRUCTIONS

This appliance must be connected to a grounded wiring system. If it should malfunction or break down, grounding provides a safe path of least resistance for electrical current, reducing the risk of electrical shock. The cord for this appliance has an equipment-grounding conductor and a grounding plug. It must only be plugged into an outlet that is properly installed and grounded in accordance with all local codes and ordinances.

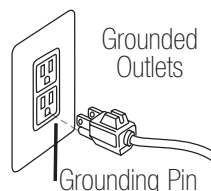

⚠ WARNING:

Improper connection of the equipment-grounding conductor can result in a risk of electrical shock. Check with a qualified electrician or service person if you aren't sure if the outlet is properly grounded. **DO NOT MODIFY THE PLUG.** If it will not fit the outlet, have a proper outlet installed by a qualified electrician. This appliance is designed for use on a nominal 120-volt circuit, and has a grounding attachment plug that looks like the plug in the drawing above. Make certain that the appliance is connected to an outlet having the same configuration as the plug. No plug adapter should be used with this appliance.

Product view

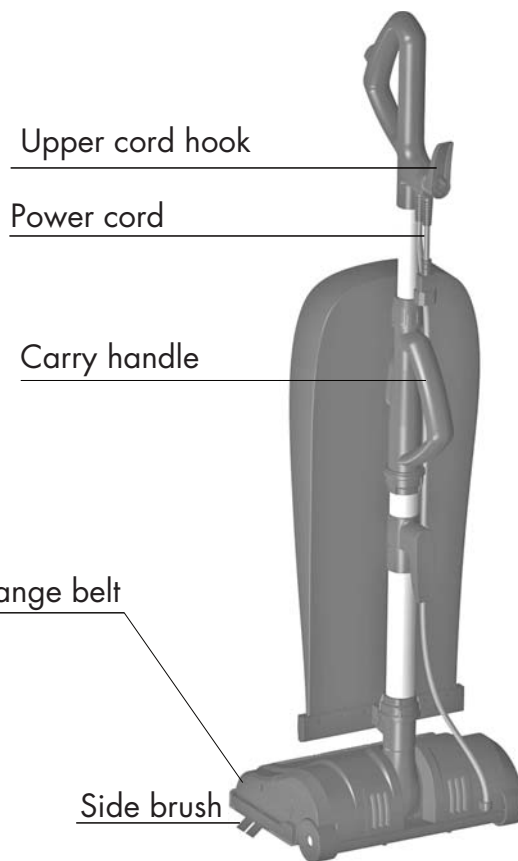
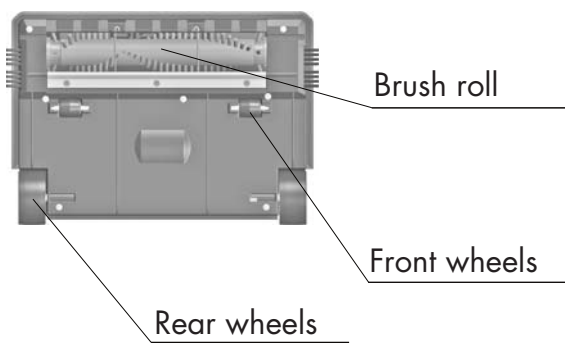

Assembly Instructions

1. With ON/OFF switch facing the front of the unit. Insert the end of the upper handle into the top of the vacuum as shown in the illustration at left. Push down firmly until the upper handle is seated all the way in the vacuum.

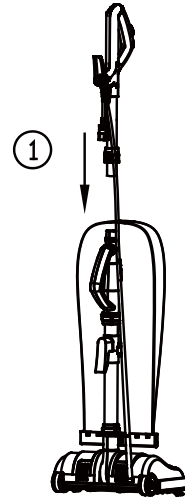

2. Tighten the upper collar.

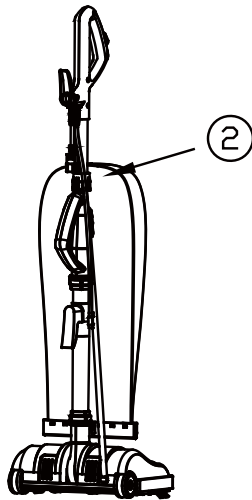

3. Press the cord into the cord clip, and ensuring the cord is fully rested in clip.

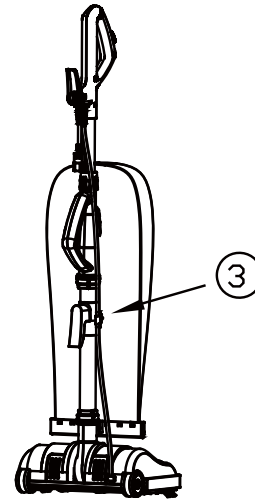

4. Connect the extension cord to the power cord male plug, and a cord connector to be used to avoid the loose connection between power cord and extension cord. (Refer to the below illustrations.)

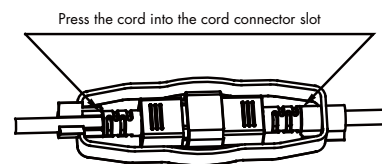
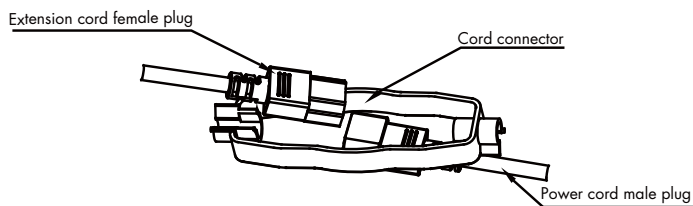

A new filter bag has been installed at the factory. Your vacuum cleaner is now ready for use.

Operating Instructions

POWER SWITCH

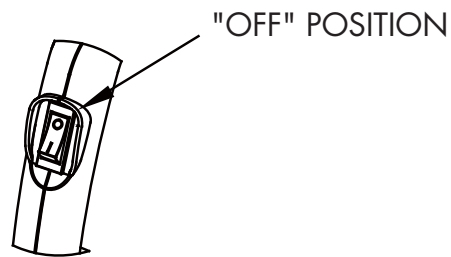

"OFF" POSITION

The "O" switch position turns the power off to the vacuum and should be used when the vacuum is unplugged and the vacuum is stored for the next use. Always turn the vacuum OFF before unplugging it from the electrical outlet.

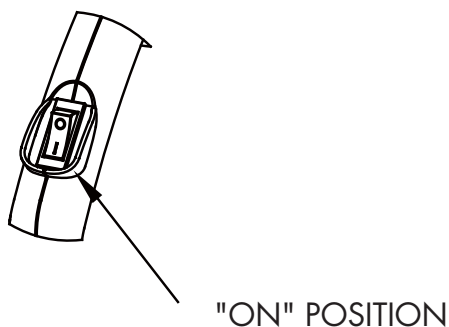

"ON" POSITION

Press the switch to the "I" position to turn on the vacuum when using for carpet and hard floors. When the vacuum is ON the brush roll is engaged and the suction is activated.

Although your upright will pick up pins, paper clips, and other small objects, it is recommended that these be removed from the floor before you vacuum. Failure to do so may result in permanent damage to the motor suction fan and its housing.

This vacuum should only be operated with the original power/extension cord. Replace with a genuine Bissell Commercial replacement power/extension cord.

Operating Instructions

HANDLE RELEASE

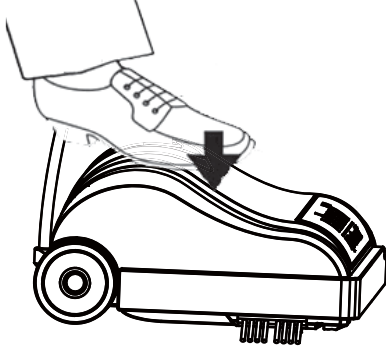

To release the handle, press on the base of the vacuum with your foot as shown at left. The handle is now free to lower for normal vacuuming.

HANDLE LOCKING



When finished vacuuming you may lock the handle in the upright position as shown at left by simply moving the handle up until it stops. **IMPORTANT!** Never leave the vacuum cleaner running in this position as it may cause damage to the floor or to your vacuum cleaner.

MAXIMUM HANDLE RETRACTION



The vacuum handle can be lowered all the way to the floor for cleaning under chairs and low furniture. Simply push down on the handle (as shown above left) and lower it to the desired height.

MAINTENANCE

CHANGE THE FILTER BAG

Refer to the illustrations at left. **ALWAYS switch off the vacuum cleaner and unplug it before replacing the filter bag.**

1. Unzip the outer bag.



2. Remove the filter bag by pulling the collar off the connector and place bag in trash.



3. Connector for filter bag.



4. Place new filter bag into outer bag and push cardboard collar on filter bag onto connector.



5. Press on edges of filter bag collar to insure the filter bag is completely installed.

IMPORTANT:

Check to make sure filter bag collar is behind the lips of the connector. This will prevent dust from leaking into outer bag.

6. Zip outer bag close.

IMPORTANT! Never attempt to empty and reuse a filter bag. This will degrade the performance of your vacuum cleaner and may cause damage to the vacuum cleaner.

CLEARING A BRUSH ROLL JAM

IMPORTANT! DO NOT ATTEMPT TO TOUCH THE BRUSH ROLL OR CLEAR THE BRUSH ROLL OF ANY OBSTRUCTION WITHOUT SWITCHING THE VACUUM OFF AND UNPLUGGING IT FROM THE OUTLET. FAILURE TO DO SO MAY RESULT IN PERSONAL INJURY.

1. Carefully inspect the brush roll for tangled hair, carpet strings or large debris. Beware of any sharp objects that may have become lodged in the brush roll area. **DO NOT** pull on anything that has jammed tightly around the brush roll as it may damage the vacuum cleaner.

2. Use scissors to carefully cut these objects off the brush roll and remove them from the vacuum cleaner.

3. Changing the brush should be performed by an authorized Bissell Commercial vacuum dealer.

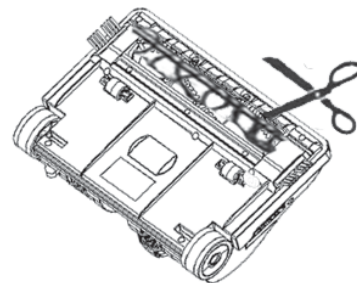

MAINTENANCE

CHECKING THE DRIVE BELT

⚠ WARNING: Unplug cord from electrical outlet before servicing.

1) Remove the screw located on side of power head.

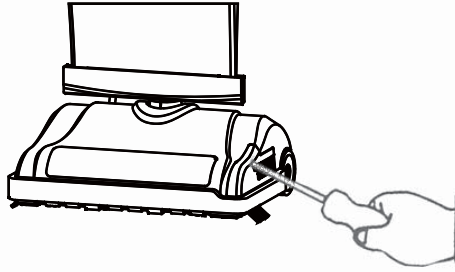

2) Slide the door forward by prying open with a screwdriver or coin.



3) Remove the belt from the brush roll pulley and the motor drive shaft, clean the residue off the broken belt if needed.

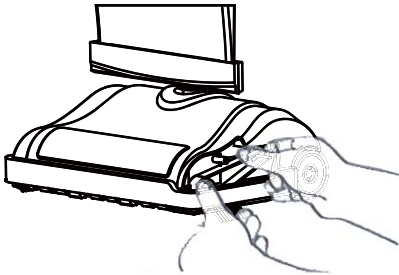

4) Loop the new belt over the motor drive shaft. Place the opposite end of the belt on the brush roll pulley.

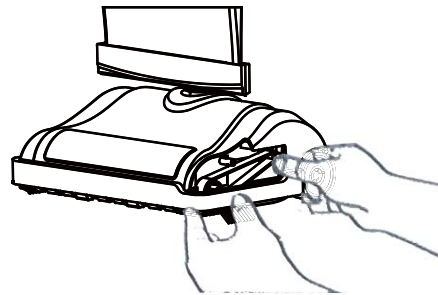

5) Rotate the brush roll several complete revolutions to ensure that no part of the belt is overhanging the end of the motor drive shaft.

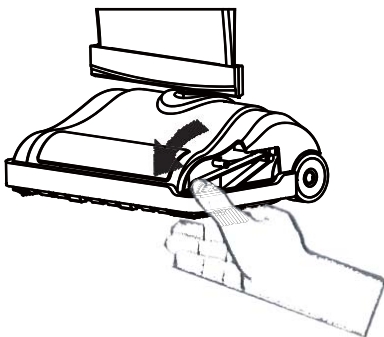

6) Slide the door back and replace screw.

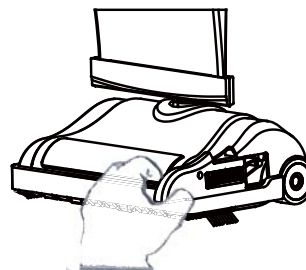

MAINTENANCE

CLEARING A CLOGGED VACUUM CLEANER

⚠ WARNING: Unplug cord from electrical outlet before servicing.

1. Unhook the bottom of the outer bag. Twist lower collar counterclockwise to slide up. Pull the tube out of the base, and check if there are obstructions in the tube and the fan housing. Remove the obstructions. Also check O-ring on the tube, and replace if damaged.

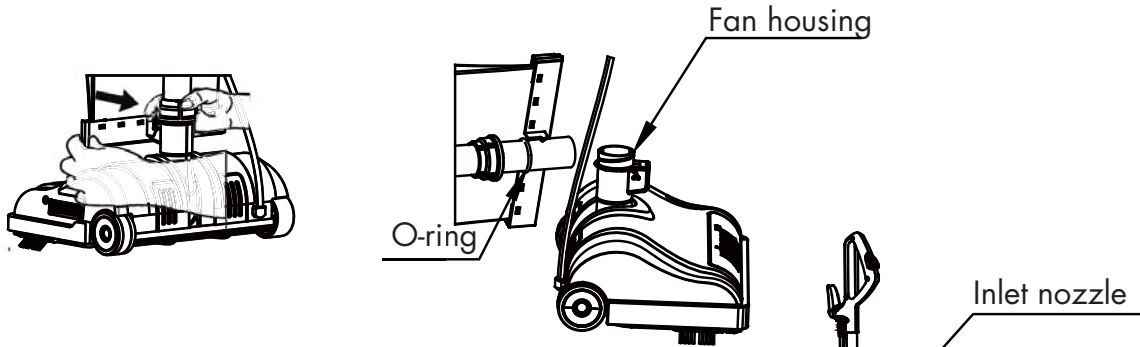

2. Remove the filter bag and check the inlet nozzle for any obstructions.

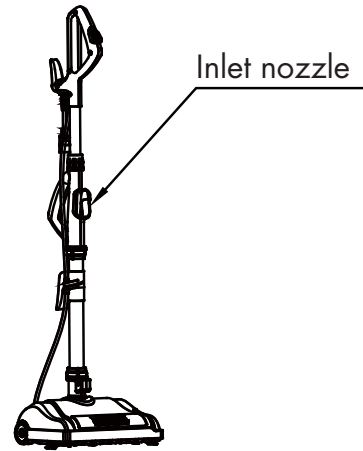

POWER CORD AND STORAGE

1. Do not pull or carry by cord, use cord as a handle, close a door on cord or pull cord around sharp edges or corners. Do not run appliance over cord. Keep cord way from heated surfaces.
2. Do not unplug by pulling on cord. To unplug, grasp the plug, not the cord. Do not handle plug or appliance with wet hands.
3. Use only 3-wire extension cords that have 3-prong grounding type plugs and 3-pole cord connectors that accept the plug from the product. Use only extension cords that are intended for extra-hard service. These extension cords are identified by a marking, such as "SJT". Use only extension cords having an electrical rating no less than the rating of the product. Do not use damaged extension cords. Examine the extension cord before using, and replace if damaged. Do not damage the extension cord and do not pull on any cord to disconnect.
4. Wind the cord around the upper and lower cord hook when storing, and swivel the upper cord hook to release the cord before using.



Warranty – BISSELL® BigGreen Commercial™ Vacuums

This warranty gives you specific legal rights, and you may also have other rights which may vary from state to state. If you need additional instruction regarding this warranty or have questions regarding what it may cover, please contact BISSELL® BigGreen Commercial™ Customer Care by E-mail, telephone, or regular mail as described below.

Limited One-Year Warranty

Subject to the *EXCEPTIONS AND EXCLUSIONS identified below, upon receipt of the product BISSELL® BigGreen Commercial™ will repair or replace (with new or remanufactured components or products), at BISSELL® BigGreen Commercial™ option, free of charge from the date of purchase by the original purchaser, for two years any defective or malfunctioning part.

See information below on "If your BISSELL® BigGreen Commercial™ product should require service".

This warranty does not apply to fans or routine maintenance components such as filters, belts, bumpers, bags, or brushes. Damage or malfunction caused by negligence, abuse, neglect, unauthorized repair, or any other use not in accordance with the user's guide is not covered.

If your BISSELL® BigGreen Commercial™ product should require service:

Contact BISSELL® BigGreen Commercial™ Customer Care to locate a BISSELL® BigGreen Commercial™ Authorized Service Center in your area.

If you need information about repairs or replacement parts, or if you have questions about your warranty, contact BISSELL® BigGreen Commercial™ Customer Care.

Website

www.bissellcommercial.com

Or Call:

BISSELL® BigGreen Commercial™ Customer Care
800-242-1378
Monday - Friday 8 am - 5 pm ET

Or Write:

BISSELL® BigGreen Commercial™
100 Armstrong Rd Suite 101 Plymouth Ma 02360
ATTN: Customer Care

BISSELL® BIGGREEN COMMERCIAL™ IS NOT LIABLE FOR INCIDENTAL OR CONSEQUENTIAL DAMAGES OF ANY NATURE ASSOCIATED WITH THE USE OF THIS PRODUCT. BISSELL®BIGGREEN COMMERCIAL™ LIABILITY WILL NOT EXCEED THE PURCHASE PRICE OF THE PRODUCT.

Some states do not allow the exclusion or limitation of incidental or consequential damages, so the above limitation or exclusion may not apply to you.

*EXCEPTIONS AND EXCLUSIONS FROM THE TERMS OF THE LIMITED WARRANTY

THIS WARRANTY IS EXCLUSIVE AND IN LIEU OF ANY OTHER WARRANTIES EITHER ORAL OR WRITTEN. ANY IMPLIED WARRANTIES WHICH MAY ARISE BY OPERATION OF LAW, INCLUDING THE IMPLIED WARRANTIES OF MERCHANTABILITY AND FITNESS FOR A PARTICULAR PURPOSE, ARE LIMITED TO THE TWO YEAR DURATION FROM THE DATE OF PURCHASE AS DESCRIBED ABOVE.

Some states do not allow limitations on how long an implied warranty last so the above limitation may not apply to you.

BISSELL® BigGreen Commercial™ Customer care

For information about repairs or replacement parts, or questions about your warranty, call:

BISSELL® BigGreen Commercial™ Customer Care
800-242-1378

Monday - Friday 8 am - 5 pm ET

Or write:

BISSELL® BigGreen Commercial™

100 Armstrong Rd Suite 101 Plymouth Ma 02360

ATTN: Customer Care

Or visit the BISSELL® BigGreen Commercial™ website -

www.bissellcommercial.com

When contacting BISSELL® BigGreen Commercial™, have model number of cleaner available.

Please record your Model Number: _____

Please record your Purchase Date: _____

BISSELL®
BigGreen Commercial™

©2014 BISSELL® BigGreen Commercial™

100 Armstrong Rd Suite 101

Plymouth Ma 02360

All rights reserved. Printed in China

Part Number 160-0964

June 23/14

Visit our website at:

www.bissellcommercial.com