

# Calabria II 26" Ceramic Tile Side Table

Owner's Manual



If you have any problems with this product, DO NOT RETURN IT TO THE STORE.  
CALL OUR CUSTOMER SERVICE HOT-LINE at  
**866-851-3006**,  
8am - 8pm (EST), Monday - Friday.

## WARRANTY

**This warranty is a limited warranty, and applies to the original purchase only. Proof of purchase is required. This is a residential warranty and does not apply to commercial use. This collection carries a 5 year limited warranty and is valid from original date of purchase to the original owner (proof of purchase required): NOTE: Glass breakage is not a warranted item.**

### **Frame (Cast, Extruded Aluminum) – 5 Years**

If the furniture frame fails structurally (i.e. broken frame or welds) within 5 years from the purchase date, we will replace in the original color and style, if available or in a similar color and style if the original has been discontinued. Damage to frames or welds due to freeze damage and/or improper assembly are not covered.

### **Frame (Steel, Wrought Iron) – One Year**

Wrought Iron and steel furniture is warranted for (1) year from the original purchase date against defects in manufacturing and/or workmanship. **NOTE:** Steel and wrought iron are not warranted for rust, corrosion, or rust staining.

### **Wicker Weave (Resin) and/or Straps – One Year**

Straps and/or wicker weave shall be warranted against separation or breaking for one (1) year from the date of purchase. Discoloration and /or fading due to exposure to elements, chemicals or harsh cleaning products are not covered.

### **Powder Coat and/or Paint – One Year**

Finishes shall be warranted against blistering, cracking, or peeling for a period of one (1) year from the original date of purchase. We will replace in the original color and style, if available or in similar color and style if the original has been discontinued. Scratches, chips, and abrasion due to normal wear and tear are not covered.

### **Fabrics and Cushions – One Year**

All fabrics and cushions shall be warranted against separation at the seams for a period of one (1) year from the original date of purchase by the initial consumer. We will repair or replace any cushion or fabric in the original color and style, if available, or in similar color and style if the original has been discontinued. Fading or discoloration due to exposure to harsh chemicals is not covered.

### **Umbrellas – One Year**

Umbrellas are warranted against failure structurally within one year from the date of purchase, due to manufacturer's defects only. Umbrella bases are not covered. **Note: Umbrellas should only be used with a table and umbrella base. Do not use in high wind or storms.**

### **Component Parts – One Year**

If a component part fails due to manufacturing defects within one (1) year from the date of purchase, we will, replace the part.

### **Alternative Stone Tops – One Year**

Tops are warranted for one (1) year against defects in manufacturing and/or workmanship.

### **Shipping**

If required, we will pay for shipping of replacement products for the period of one (1) year from the date of purchase. After (1) year it will be the original purchasers' responsibility to pay for freight and packaging.

### **Exclusions**

Failure caused by unreasonable or abusive use, fire, freight damage, acts of nature (such as, but not limited to freezing or high winds), suntan oil or other chemicals, normal fading, scratching or chipping of the finish, fading, weathering or staining or discoloration of furniture, accidental damage, repair, or modifications by customer, glass breakage, normal wear and tear are excluded from the warranty.

Furniture used in commercial, contract or any other non-residential applications; clearance items, display models, and all other as is purchased items are not covered under this warranty. In addition, BJI, Inc. will not be responsible for loss of use or time, inconvenience, travel, packaging, or any other consequential/incidental damages. In no event shall BJI, Inc.'s responsibility exceed the value of the replacement part/product.

### **Care and Maintenance**

Be careful to never allow water to build up in frames as this will cause corrosion and freeze damage in cold climates. Wash all frames with a solution of mild soap and water. Rinse with clean water and dry with a soft absorbent cloth towel. Frames can be treated with a liquid wax for maximum protection against UV rays and/or salty damp air. If your set includes cushions, slings, and/or an umbrella they may be cleaned by hand with a solution of soap and water with a clean water rinse. (Never machine wash cushions, slings or umbrella covers as this will result in shrinkage or damage).

After cleaning cushions tip on end and allow to drip dry. (Never use a commercial or home dryer to tumble dry fabric goods).

Do not use bleach or solvents to clean any product! This will void the warranty.

**Lack of original receipt will void warranty!**

**Customer Service: Monday-Friday 8:00 a.m.-8:00 p.m. EST**

By FAX: 502-410-0702







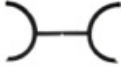

By PHONE: 866-851-3006

Address: 2700 Stanley Gault parkway, Suite 130, Louisville, KY, 40223

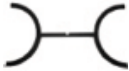
**CAUTION:** Read all the instructions before assembly. Failure to do so may result in faulty assembly and potential injury!

Assemble product on a soft, non-abrasive surface such as a carpet or cardboard to avoid damaging the item. Seek assistance to assemble bulky or heavy items. After final alignment, make sure all bolts are securely tightened with hex caps pressed in place.

## Parts List

Item	Part Name		Qty	Item	Part Name		Qty
A	Leg"A"		1	F	M6x 15mm Hex Head Bolt		4
B	Leg"B"		1	G	Washer		4
C	Table Top		1	H	Wrench		1
D	M6 Hex Cap		4	I	Bumper		16
E	Tile		4				

**Do Not tighten screws until product is completely assembled.**

Step 1. Assemble leg "A"(A) and leg "B"(B) together.  
(Figure 1)

Note: The legs must be assembled so that it will sit level when turned upright.

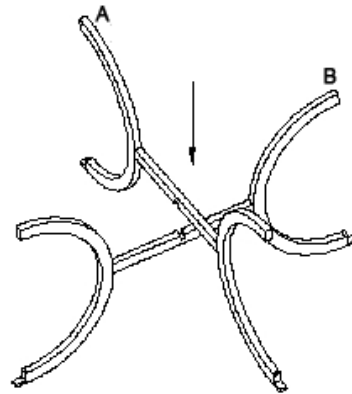

**Figure 1**

Step 2. Secure legs(A&B) into table rim(C) by using M6 Hex cap(D), M6\*15mm Hex head bolt(F), washer(G), wrench(H).  
(Figure 2)

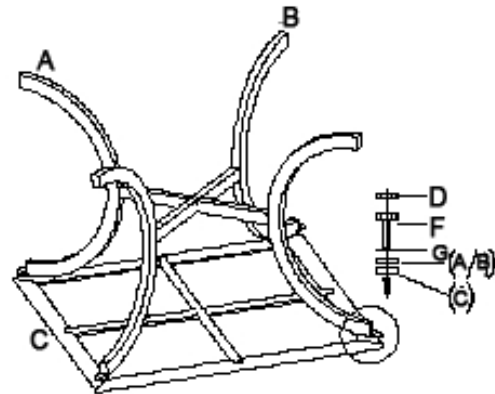

**Figure 2**

Step 3. Turn table over and place in desired location.

Step 4. Attach all bumpers(I) on the four corner of every square box and put tiles(E) in each empty square. Your table now is ready to enjoy! (Figure 3)

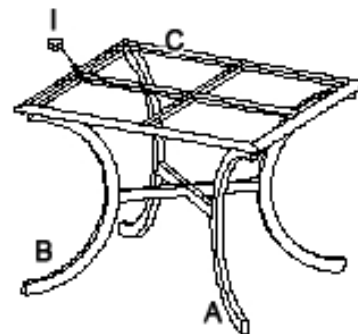

**Figure 3**

**WARNING: Never stand, sit or allow children to crawl on table top !**  
**Customize the appearance by updating/changing the tiles with most standard 12" tiles.**