



Metal Lath and Accessories

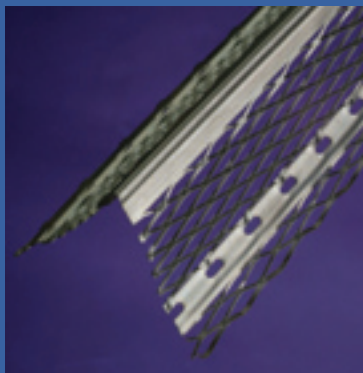
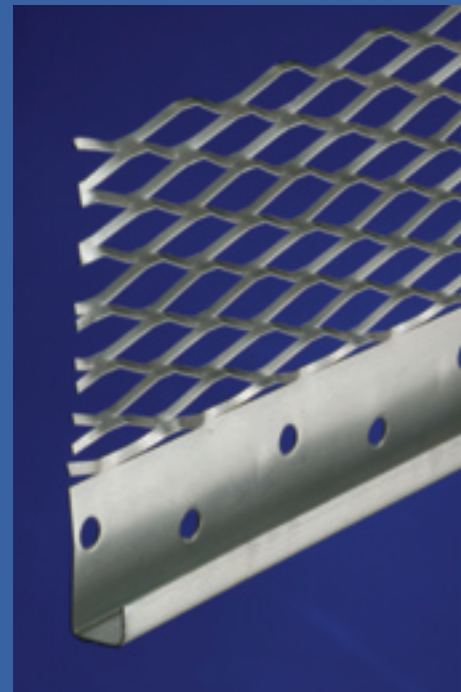

TABLE OF CONTENTS

Diamond Mesh Lath	Page 1	J-Metal Bead	
Flat Lath (Galvanized and Stainless Steel)		Foundation Weep Screed (FHA #7)	
Self-Furred Lath — Dimpled		Control Joint (VV or M Type, #15 Joint)	
Self-Furred Lath — V Grooved		Inside Corner Control Joint (#30 Joint)	
Tilath™ Paper Backed Metal Lath	Page 2	Griplock J Control Joint (#XJ15 Joint)	
Flat and Self-Furred Tilath™		M-Slide™ 2-Piece Expansion Joint	
Tilath™ Rib Lath (1/8" Rib)		Zinc Control Joint	
Tilath™ Starter Strips			
Rib Lath	Page 3	Installation Guidelines for Metal Lath ...	Page 10
1/8" Flat Rib Lath		Installation Detail Photos	Page 11
3/8" High Rib Lath		Metal Lath Specification	Pages 12-13
Support Spacing for Metal Lath	Page 3	Specialty Metal Products	Page 14
Spray Lath Products	Page 4	N093 Drywall/DEFS Control Joint	
Spray Rib Lath — Flat (1/8") Rib		Wire Corners	
Spray Rib Lath — High (3/8") Rib		Galvanized Hanger and Tie Wire	
Managing Quality Control	Page 4	Galvanized Cold Rolled Channel	
Metal Accessories	Page 5	SS304/316 Stainless Steel Lath	Page 15
X-1 Corner Bead		Secura Lath® Spec Data	Page 15
X1-N Narrow Wing Corner Bead		Security Mesh™ System	Page 16
X-2 Reinforced Corner Bead		Security Mesh™ Specification	Page 17
Cornalath (Cornerite)		Manufacturing &	
Striplath		Distribution Centers	Back Cover
Metal Accessories	Pages 6-9		
X-66 Expanded Flange Casing Bead			
N-66 Narrow Wing Casing Bead			

QUALITY PRODUCTS – COAST TO COAST



A GIBRALTAR INDUSTRIES COMPANY 

ALABAMA METAL INDUSTRIES CORPORATION

3245 Fayette Avenue • Birmingham, AL 35208

Phone (205) 787-2611 • (800) 366-2642 • Fax (205) 786-6527

www.amico-lath.com

DIAMOND MESH LATH

Flat Lath is manufactured from prime quality steel sheets that are slit and expanded to form small diamond shaped openings. This large number of openings provides more plaster keys, providing better scratch coat bonding in either pumped or troweled applications. Each sheet has square ends and smooth parallel edges on sides for fast, easy handling and bending for curved surfaces.

Weight/sq. yard	Finish	Sheet weight	Nominal sheet size	Sheets/bundle	Bundles/pallet	Pallet weight
1.75 lbs.*	Galvanized	3.5 lbs.	27" x 97"	10	50	1750 lbs.
2.5 lbs.	Galvanized	5.0 lbs.	27" x 97"	10	50	2500 lbs.
3.4 lbs.	Galvanized	6.8 lbs.	27" x 97"	10	50	3400 lbs.
1.75 lbs.	Stainless	3.5 lbs.	27" x 97"	10	25	875 lbs.
2.5 lbs.	Stainless	5.0 lbs.	27" x 97"	10	25	1275 lbs.
3.4 lbs.	Stainless	6.8 lbs.	27" x 97"	10	25	1700 lbs.

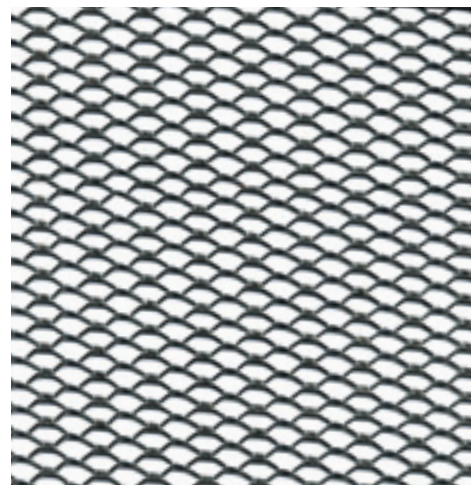

Self-Furred Lath is used extensively in exterior stucco and stone work over sheathing and as a plaster base over masonry walls. Self-furring dimples or embossed "V" grooves hold the lath approximately 1/4" away from solid surfaces to aid in the keying of stucco to the lath. **AMICO self-furred lath does not require additional self-furring mechanisms to function as required by ASTM C1063.**

Dimpled (dimple spacing 5 1/4" on length with offset rows 5 1/4" apart on width)

Weight/sq. yard	Finish	Sheet weight	Sheet size	Sheets/bundle	Bundles/pallet	Pallet weight
1.75 lbs.*	Galvanized	3.5 lbs.	27" x 97"	10	25	875 lbs.
2.5 lbs.	Galvanized	5.0 lbs.	27" x 97"	10	25	1250 lbs.
3.4 lbs.	Galvanized	6.8 lbs.	27" x 97"	10	25	1700 lbs.



V Grooved (embossed "V" grooves spaced 6" on center lengthwise)

Weight/sq. yard	Finish	Sheet weight	Sheet size	Sheets/bundle	Bundles/pallet*	Pallet weight
1.75 lbs.*	Galvanized	3.5 lbs.	27" x 97"	10	50	1750 lbs.
2.5 lbs.	Galvanized	5.0 lbs.	27" x 97"	10	50	2500 lbs.
3.4 lbs.	Galvanized	6.8 lbs.	27" x 97"	10	50	3400 lbs.

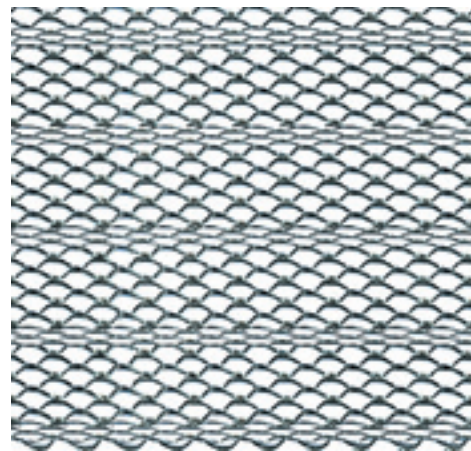

As per current revisions of ASTM C-1063, metal lath applied to solid substrates must have 1/4" self-furring properties, built into the lath sheet. Therefore, AMICO recommends the use of self-furred (SF) lath over solid substrates, as required by current codes. Self furred lath is not required over framing members less than 1 5/8" in diameter or over open framing. (25-bundle pallets available in Fontana, CA facility.)

*1.75 lb. is not recognized in ASTM C847, but is referenced in one-coat stucco systems and tile work.

TILATH™ PAPER BACKED METAL LATH

Tilath™ is diamond mesh lath, regular or self-furred, to which Grade D, Style 2, asphalt saturated paper (WRB) is applied in an “offset” fashion, providing a ship lap application, per ASTM C-1063 (see the illustrations below). Tilath is an ideal selection for applications requiring two layers of WRB, where the synthetic air barrier provides the first barrier. Furthermore, Tilath is an ideal choice for veneer stone installations when the first WRB is already installed.

Flat and Self-Furred Tilath™

Weight/ sq. yard*	Finish	Sheet weight*	Sheet size	Sheets/ bundle	Bundles/ pallet	Pallet weight
1.75 lbs.	Galvanized	3.77 lbs.	27" x 97"	10	25	920 lbs.
2.5 lbs.	Galvanized	5.18 lbs.	27" x 97"	10	25	1295 lbs.
3.4 lbs.	Galvanized	6.81 lbs.	27" x 97"	10	25	1745 lbs.

*Weight per sq. yard does NOT include the Grade D WRB; sheet weight DOES include the approximate weight of the paper.

Tilath™ Rib Lath (1/8" rib)

Weight/ sq. yard	Finish	Sheet weight*	Sheet size	Sheets/ bundle	Bundles/ pallet	Pallet weight
2.75 lbs.	Galvanized	5.63 lbs.	27" x 97"	10	25	1420 lbs.
3.4 lbs.	Galvanized	6.81 lbs.	27" x 97"	10	25	1745 lbs.

*Weight per sq. yard does NOT include the Grade D WRB; sheet weight DOES include the approximate weight of the paper.

Tilath™ Starter Strips are compatible Grade D asphalt paper strips to be used over the foundation weep screed when installing offset, paper backed lath. **Starter Strips** are printed with incremental 1" marks and larger marks at 12" and 16" to assist the installer in fastening to the wall framing. Because of their Weather Resistant Barrier (WRB) properties, they also provide protection around doors and windows, behind stucco accessories and anywhere WRB strips are needed.

Roll Size	Rolls/Carton	Carton Weight	Cartons/pallet
6" x 225'	6	30 lbs.	30

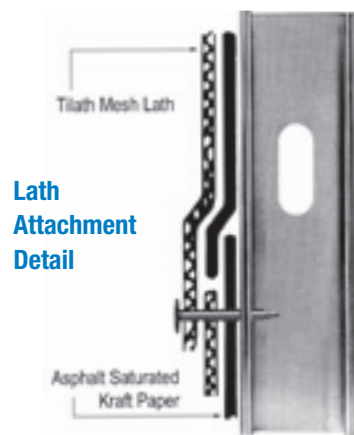

Tilath™ Paper Backed Lath Construction Detail

Tilath™ is produced with lath and WRB *offset* on one side and end to allow the lath to overlap at sheet joints. Tilath™ is to be “shingled” up the wall, beginning with a 6" Tilath Starter Strip (Grade-D paper) at base of wall, placing the Starter Strip over the weep screed attachment flange. Then, the Tilath sheet is attached with metal overhang facing down so that the lap detail can be achieved (as shown at right).

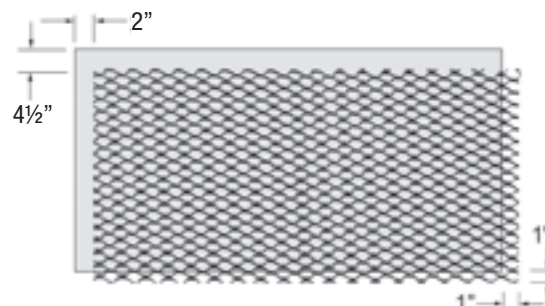

RIB LATH

Rib Lath is used for stucco and stone applications and has unique solid metal “ribs” running parallel down the length of the lath sheet. The rib lath sheet provides greater stiffness and is allowed to span over studs, specific to the product applications outlined below. See **Support Spacing for Metal Lath** (below) for product selections.

1/8” Flat Rib Lath has eighteen ribs, 1/8” high, spaced 1 1/2” on center. The 2.75 lbs. product may be installed over horizontal spans up to 16” on center, and the 3.4 lbs. product may be installed over spans of 19” on center, when following ASTM C-1063. This lath sheet still requires furring on solid substrates.

Weight/sq. yard	Finish	Sheet weight	Sheet size	Sheets/bundle	Bundles/pallet	Pallet weight
2.75 lbs.	Galvanized	5.5 lbs.	27” x 97”	10	50	2750 lbs.
3.4 lbs.	Galvanized	6.8 lbs.	27” x 97”	10	50	3400 lbs.

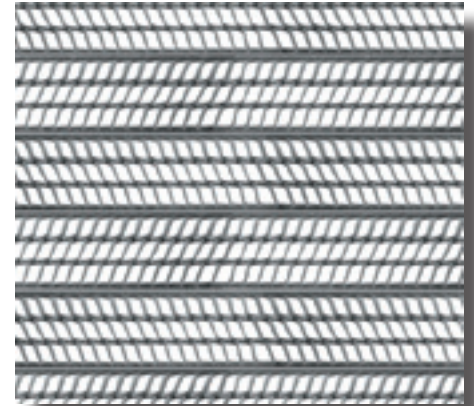

3/8” High Rib Lath is designed with seven longitudinal ribs (each 3/8” deep) and eight small flat ribs in between the high ribs. This product is used almost exclusively for ceiling and soffit applications. ASTM C-1063 allows High Rib Lath to span up to 24” on center between framing both vertically and horizontally.

Weight/sq. yard	Finish	Sheet weight	Sheet size	Sheets/bundle	Bundles/pallet	Pallet weight
3.4 lbs.	Galvanized	6.8 lbs.	27” x 97”	10	50	3400 lbs.
4.0 lbs.	Galvanized	8.0 lbs.	27” x 97”	10	50	4000 lbs.

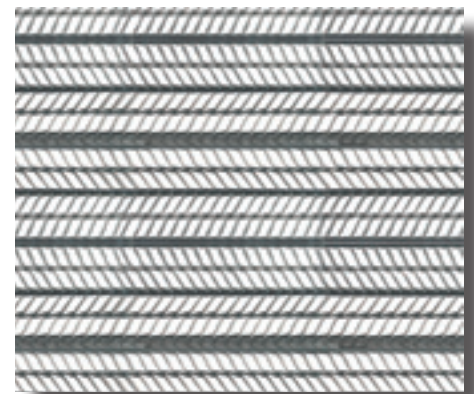

SUPPORT SPACING FOR METAL LATH

(adapted from ASTM C-1063, table 3)

Types of Lath ³	Nominal Weight (per sq. yard)	VERTICAL SPACING (INCHES)			HORIZONTAL (INCHES)	
		Wood	Solid Plaster (Metal)	Other (Metal)	Wood or Concrete	Metal
Diamond Mesh Lath	2.50 lbs.	16 ¹	16 ¹	12	12	12
	3.40 lbs.	16 ¹	16 ¹	16	16	16
Flat Rib Lath	2.75 lbs.	16	16	16	16	16
	3.40 lbs.	19	24	19	19	19
3/8” Rib Lath	3.40 lbs.	24	24 ²	24	24	24

¹ Spans may be increased to 24” o.c. with self-furred metal lath over solid sheathing assemblies approved for this use.

² May be used in studless partitions.

³ Metal lath used as reinforcement for plaster substrate shall be furred away from vertical supports at least 1/4”. Self-furred lath meets furring requirements. EXCEPTION: Furring of expanded metal lath is not required on supports having a bearing surface width of 1 5/8” or less.

SPRAY LATH PRODUCTS

Spray Lath is used primarily on the West coast, where stucco is spray applied to the surface of the lath to build stucco thickness. Rib Lath is often attached directly to the vertical framing members without a solid board substrate included.

AMICO spray products include:

Spray Rib Lath - Flat (1/8") Rib has two (2) strips of kraft paper, 12" wide, attached to the lath, permitting visual alignment of lath for mechanical attachment of the rib to the substrate. Flat Rib is allowed by Building Code to span 16" on center for the 2.75 lb. Flat Rib, 19" on center for 3.4 lb. Flat Rib.

Weight/ sq. yard	Sheet size	Sheet weight	Sheets/ bundle	Bundles/ pallet	Pallet weight
2.75 (1/8") lbs.	27" x 97"	5.5 lbs.	10	50	2750 lbs.
2.75 (1/8") lbs.	27" x 48"	2.75 lbs.	10	50	1375 lbs.



Spray Rib Lath - High (3/8") Rib is a more rigid lath product than Diamond Mesh, and like Spray Lath, has strips of kraft paper attached between the ribs. The additional rigidity is well suited for horizontal applications such as soffits. The 3.4 lb. High Rib allows for (up to) 24" spans.

Weight/ sq. yard	Sheet size	Sheet weight	Sheets/ bundle	Bundles/ pallet	Pallet weight
3.4 (3/8") lbs.	27" x 97"	6.8 lbs.	10	50	3400 lbs.



MANAGING QUALITY CONTROL

Metal lath may look the same when palletized and stocked in the warehouse, but may be different when observed in the bundles, on the jobsite. Before it's installed, is it the correct weight, length and width?

To be assured your lath is CODE COMPLIANT, AMICO straps all diamond mesh bundles with the appropriate identification, including weight, ASTM #, ICC-ESR# and Made in U.S.A. Furthermore the lath bundle's straps are color-coded (red strapping for 3.4#, blue for 2.5# and yellow for 1.75#) for your assurance.

As AMICO lath bundles are brought to the job, one can be assured they are CODE COMPLIANT by observing color coded strapping complies with the project specifications. Each bundle is identified as seen here:

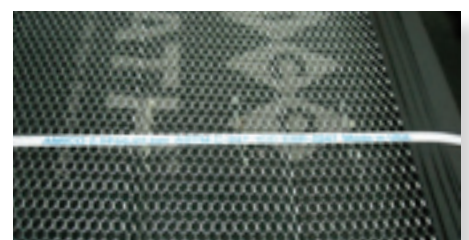

METAL ACCESSORIES

Corner Beads (X-1 and X-2) provide exterior corner protection and a straight ground for screeding. The **X-1 Corner Bead** has a 3" wide flange that is flexible and adaptable to various ground heights. The **X-1-N Narrow Wing Corner Bead** has the same design as X-1, but with a shorter, 2½" wide flange. The **X-2 Reinforced Corner Bead** is superior in strength to X-1, due to added stiffener strips in the ¾" wide flanges. The chart below outlines the specifics of each style.

Style	Length**	Finish	Pieces/carton	Weight/carton	Cartons/pallet	Pallet weight
X-1*	10'	Galvanized	30	56 lbs.	21	1166 lbs.
X-1	10'	Zinc	30	49 lbs.	21	1008 lbs.
X-1-N	8'	Galvanized	40	55 lbs.	20	1095 lbs.
X-1-N	8'	Zinc	40	48 lbs.	20	935 lbs.
X-1-N	10'	Galvanized	30	51 lbs.	21	1078 lbs.
X-1-N	10'	Zinc	30	44 lbs.	21	920 lbs.
X-2	10'	Galvanized	30	76 lbs.	21	1600 lbs.
X-2	10'	Zinc	30	67 lbs.	21	1407 lbs.
Wire	8', 9', 10'	Galvanized	40	44 lbs.	24	1056 lbs.

***Also available in Stainless Steel**

AMICO Wire Corners are discussed further on page 14 (Specialty Products)

Cornalath (Cornerite) is used in corners where walls intersect with walls or ceilings. The reinforcing of corners helps prevent cracks. The 105° angle offers resistance when pushed into the transition. Available in galvanized steel only.

Length	Pieces/carton	Weight/carton	Cartons/pallet	Pallet weight
2" x 2" – 4'	125	35 lbs.	30	1050.0 lbs.
2" x 2" – 8'	75	50.4 lbs.	21	1058.4 lbs.
3" x 3" – 8'	75	70.8 lbs.	15	1062.0 lbs.

Striplath is galvanized, diamond mesh lath, produced in 4" and 6" wide strips with smooth edges. Striplath is used to reinforce plaster around door and window corners, reducing cracks caused by stress.

Length	Pieces/carton	Weight/carton	Cartons/pallet	Pallet weight
4" x 8'	75	50.4 lbs.	20	1008 lbs.
6" x 8'	75	70.8 lbs.	20	1416 lbs.

**Other lengths available by request

AMICO recommends the use of zinc or vinyl accessories for all exterior applications. Contact your AMICO representative for a vinyl catalog or visit our website.

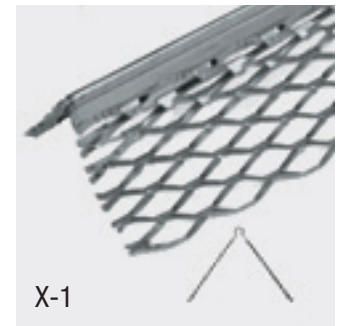
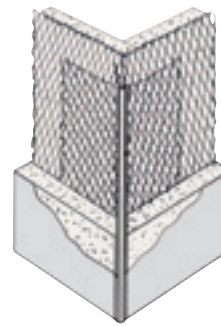

X-1

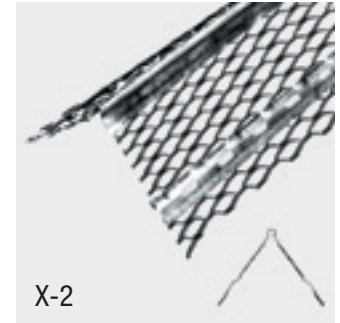
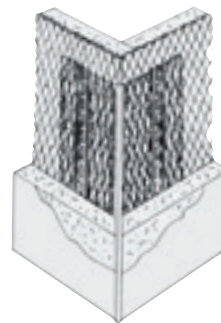

X-2

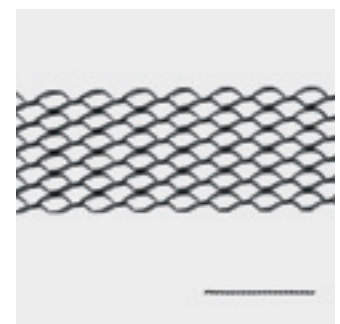
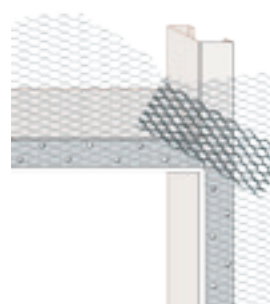
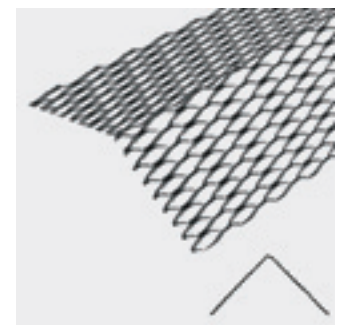
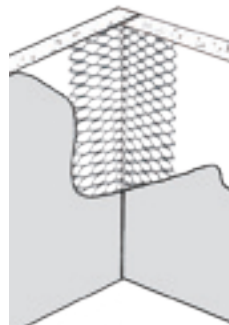

METAL ACCESSORIES

X-66 Expanded Flange Casing Bead (sometimes called “plaster stop” or “J-bead”) has a 3” expanded mesh flange with a 1/4” return leg. This trim is used to terminate plaster or stucco around doors, windows or any other opening. The chosen ground height aids in screeding the proper thickness of stucco.

Ground	Length	Pieces/ carton	Finish	Weight/ carton	Cartons/ pallet	Pallet weight
3/8"	10'	30	Galvanized Zinc	44 lbs. 42 lbs.	20	880 lbs. 840 lbs.
1/2"*	10'	30	Galvanized Zinc	47 lbs. 44 lbs.	20	940 lbs. 880 lbs.
5/8"	10'	30	Galvanized Zinc	49 lbs. 47 lbs.	20	980 lbs. 940 lbs.
3/4"*	10'	30	Galvanized Zinc	51 lbs. 49 lbs.	20	1020 lbs. 980 lbs.
7/8"*	10'	30	Galvanized Zinc	53 lbs. 51 lbs.	20	1060 lbs. 1020 lbs.
1"*	10'	30	Galvanized Zinc	56 lbs. 53 lbs.	20	1120 lbs. 1060 lbs.
1 1/4"	10'	30	Galvanized Zinc	59 lbs. 56 lbs.	20	1180 lbs. 1120 lbs.
1 1/2"	10'	30	Galvanized	76 lbs.	20	1520 lbs.

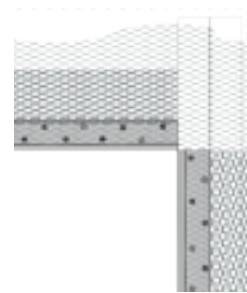
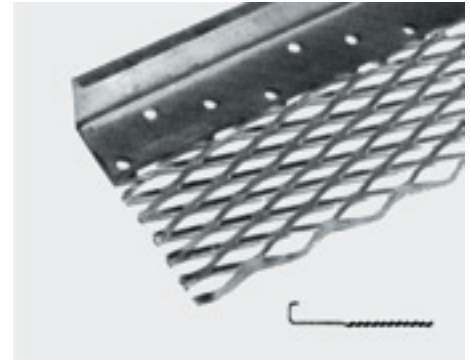

***Also available in Stainless Steel**

All X-66 Beads can be supplied with punched holes in the ground, but should not be used in lieu of a #7 FHA full weep screed at base of wall, in compliance with ASTM C1063.

N-66 Narrow Wing Casing Bead has the same basic profile as X-66, but without the expanded flange. Nail and keying holes are provided in the flange, which is approximately 1 3/8" wide. Weep holes are optional on all grounds.

Ground	Length	Pieces/ carton	Finish	Weight/ carton	Cartons/ pallet	Pallet weight
3/8"	10'	30	Galvanized Zinc**	37 lbs. 35 lbs.	30	1110 lbs. 1050 lbs.
1/2"	10'	30	Galvanized Zinc**	39 lbs. 38 lbs.	30	1170 lbs. 1140 lbs.
3/4"	10'	30	Galvanized Zinc**	44 lbs. 41 lbs.	30	1320 lbs. 1230 lbs.
7/8"	10'	30	Galvanized Zinc**	47 lbs. 44 lbs.	30	1410 lbs. 1320 lbs.
1"	10'	30	Galvanized Zinc**	47 lbs. 45 lbs.	30	1440 lbs. 1350 lbs.

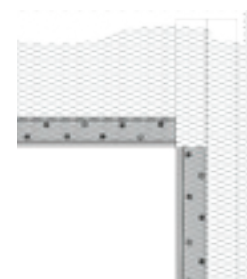
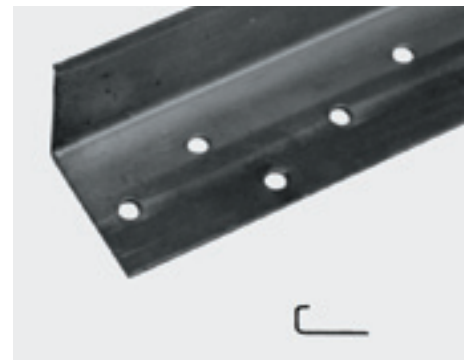

**Not a stock item. Call for lead time.

J-Metal Bead will accommodate up to 1" of rigid insulation and one-coat stucco direct applied systems or thin-veneer stone. The 26-gauge J-Metal can be punched for weep in ground flange as requested. Weeps spaced at 6" centers.

Ground A	Length	Pieces/ bundle	Nailing flange height B	Weight/ bundle	Bundles/ pallet
3/8"	10'	10	3 1/2"	26 lbs.	50
1/2"	10'	10	3 1/2"	28 lbs.	50
3/4"	10'	10	3 1/2"	29 lbs.	50
7/8"	10'	10	3 1/2"	30 lbs.	50
1 3/8"	10'	10	1 3/4" 3 1/2"	21 lbs. 35 lbs.	100 50
1 1/2"	10'	10	1 3/4" 3 1/2"	24 lbs. 36 lbs.	100 50

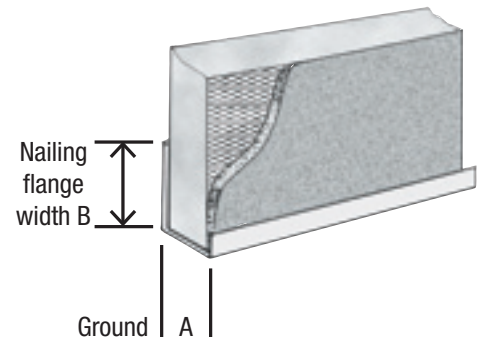
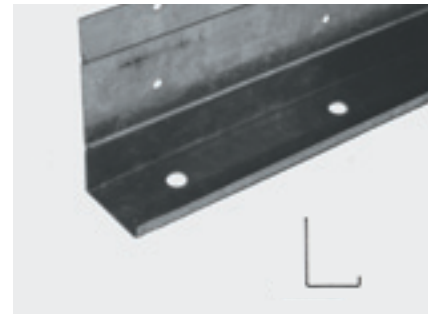

Foundation Weep Screed (FHA #7) is required at the base of walls as part of a drainage system for exterior stucco or veneer stone applications. The 3 1/2" nailing flange serves as flashing when Grade D building paper or Tilath™ Starter Strips are installed over the flange. Holes are punched into the nailing flange for easy attachment to the wall. Holes are also placed in the "V" stop to provide keying of the stucco mud when wet. As the mud cures, it will shrink slightly away from the "V" stop, allowing moisture to flow down the building paper and exit the sloped "V" stop surface. FHA #7 is manufactured in 26-gauge galvanized metal and zinc alloy. Contact AMICO for availability.

Ground A	Pieces/ bundle	Nailing flange width	Finish	Weight/ bundle	Bundles/ pallet
1/2"	10	3 1/2"	Galvanized Zinc*	32 lbs. 28 lbs.	100
5/8"	10	3 1/2"	Galvanized Zinc*	34 lbs. 30 lbs.	100
7/8"	10	3 1/2"	Galvanized Zinc*	36 lbs. 32 lbs.	100
1 3/8"	10	3 1/2"	Galvanized Zinc*	41 lbs. 37 lbs.	100
1 1/2"	10	3 1/2"	Galvanized Zinc*	43 lbs. 39 lbs.	100

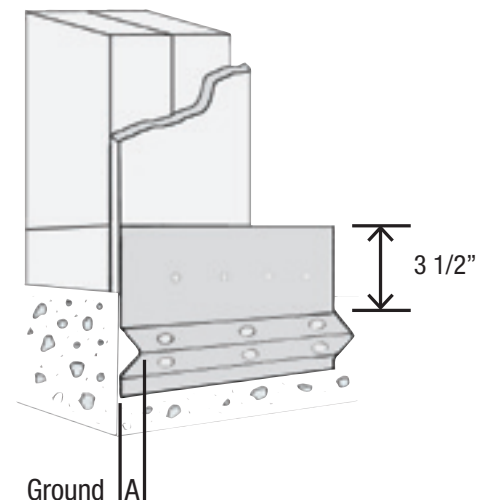
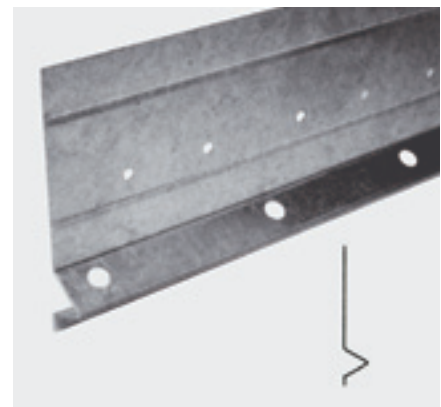

*Not a stock item. Call for lead time.

METAL ACCESSORIES

Expansion Joints versus Control Joints

Control Joints (CJ) are 1-piece joints designed to relieve stress and minimize cracking; they accommodate initial stucco shrinkage and minor thermal movement. The Control Joints are required to form membrane panels no larger than 100 sq.ft for ceilings and 144 sq. ft. for walls. On the other hand, **Expansion Joints (EJ)** are 2-piece joints designed to accommodate a full break through the structure across dissimilar surfaces or to deal with some minor structural movement.

AMICO Control Joint (VV or M-Type, #15 Joint) is designed to provide for movement to accommodate expansion and contraction caused by initial stucco shrinkage and minor thermal movement. Produced in galvanized steel and zinc alloy in 10' lengths.

Ground	Pieces/ carton	Finish	Weight/ carton	Cartons/ pallet	Pallet weight
3/8"	24	Galvanized Zinc	49 lbs. 45 lbs.	20 / 40 20 / 40	980 / 1960 lbs. 900 / 1800 lbs.
1/2"	24	Galvanized Zinc	66 lbs. 50 lbs.	20 / 40 20 / 40	1320 / 2640 lbs. 1000 / 2000 lbs.
5/8"	24	Galvanized Zinc	65 lbs. 58 lbs.	20 / 40 20 / 40	1320 / 2640 lbs. 1150 / 2300 lbs.
3/4"*	24	Galvanized Zinc	71 lbs. 61 lbs.	20 / 40 20 / 40	1420 / 2840 lbs. 1220 / 2440 lbs.
7/8"	24	Galvanized Zinc	83 lbs. 71 lbs.	20 / 40 20 / 40	1660 / 3320 lbs. 1420 / 2840 lbs.

*Also available in Stainless Steel

Inside Corner Control Joint (#30 Joint) is similar to the standard M Type joint, but the flanges are bent to an angle to form inside corners, allowing movement. Produced in galvanized steel or zinc alloy in 10' lengths. Verify availability and lead-time.

Ground	Pieces/ carton	Finish	Weight/ carton	Cartons/ pallet	Pallet weight
1/2"	24	Galvanized Zinc	66 lbs. 50 lbs.	20	1320 lbs. 1000 lbs.
3/4"*	24	Galvanized Zinc	71 lbs. 61 lbs.	20	1420 lbs. 1220 lbs.
7/8"	24	Galvanized Zinc	83 lbs. 71 lbs.	20	1660 lbs. 1420 lbs.

*Also available in Stainless Steel

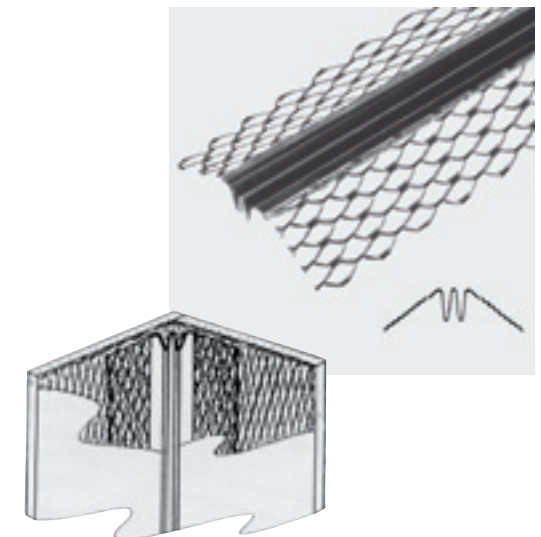
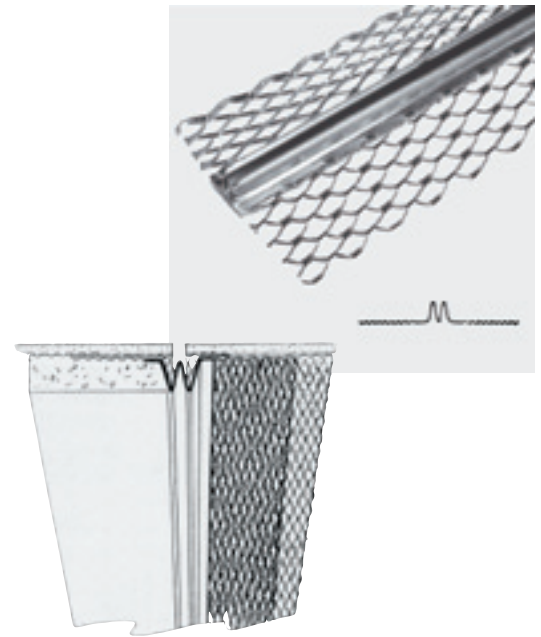

Griplock J Control Joint (#XJ15 Joint) is similar to the M Control Joint except the J design provides locking of the stucco to the edge of the joint. This design helps reduce stucco separation at the edge of the joint when stucco is forced under the J flange. Produced in 10' lengths. Griplock J comes pre-taped to ensure a clean joint.

Ground	Pieces/carton	Finish	Weight/carton	Cartons/pallet	Pallet weight
1/2"	24	Galvanized Zinc	70 lbs. 61 lbs.	20	1400 lbs. 1220 lbs.
3/4"	24	Galvanized Zinc	77 lbs. 64 lbs.	20	1540 lbs. 1280 lbs.
7/8"	24	Galvanized Zinc	80 lbs. 66 lbs.	20	1600 lbs. 1320 lbs.

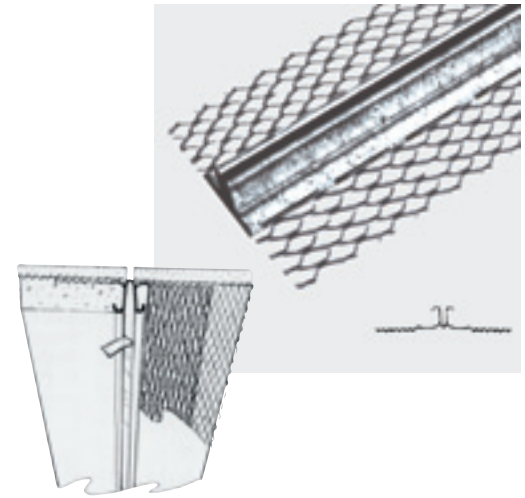

M-Slide™ 2-Piece Expansion Joint (Horizontal and Vertical) is a new water management accessory that works like the #40 Joint for movement, but improves the flashing and drainage from the area as needed. **The M-Slide™ Horizontal** combines a weep screed design with a larger, solid flange (on bottom) to provide intermediate flashing/drainage at mid-floor expansion. **The M-Slide™ Vertical** utilizes larger flanges and a stiffer design to “pre-set” the vertical joint for proper attachment. Both versions are produced in 25-gauge, G-90 pre-galvanized steel finish, providing additional protection. The 7/8" grounds will work for both 3/4" and 7/8" hard-coat systems; other size grounds and zinc alloy are available on request. Produced in 10' lengths.

Product #	Grounds	Pieces/carton	Weight/carton	Cartons/pallet	Pallet weight
M-Slide-H	7/8"	10	110 lbs.	12	1320 lbs.
M-Slide-V	7/8"	10	88 lbs.	12	1056 lbs.

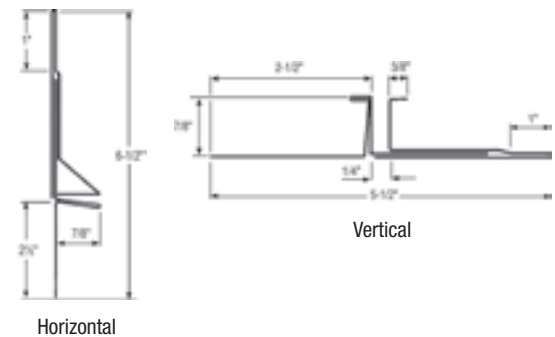
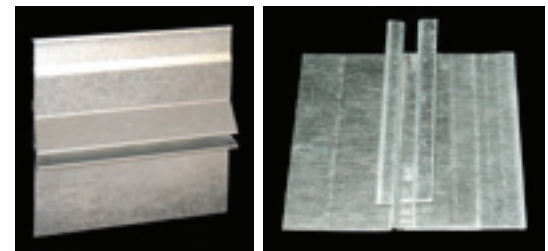

Zinc Control Joint has a solid flange with large holes that aid in the attachment of adjoining metal lath. The improved shoulder design allows for easier stucco embedment and increases holding capacity at the joint to minimize cracking. CJ comes pre-taped to ensure a clean joint. Produced in 10' lengths.

Product #	Grounds	Pieces/carton	Weight/carton	Cartons/pallet	Pallet weight
CJ380	3/8"	25	51 lbs.	20	1020 lbs.
CJ500	1/2"	25	60 lbs.	20	1200 lbs.
CJ750	3/4"	25	66 lbs.	20	1320 lbs.



INSTALLATION GUIDELINES FOR METAL LATH

These installation recommendations are intended to be instructional and accurate. This is first a guideline, providing a general overview and also equips the lather with specific installation details, based on ASTM C 1063 Standard Specification for Installation of Metal Lath.

Always consult your area building official before beginning any project to familiarize yourself with any local code requirements. This guide should not replace the designs and judgments of a qualified engineer and/or architect.

Lath Installation

Permanently attach the Weep Screed (FHA#7) to the solid substrate at the bottom of the wall, a minimum of 4-inches above grade. Begin at the right hand bottom corner of the wall. If paper backing behind the lath is required, leave the paper hanging over at the top and to the left of the sheet. Offset paper backing has the paper overlapping 1-1/2" on one end and one side and corresponding retracted on the opposite end and side, the sheets should always be installed in a horizontal application perpendicular to the framing.

Begin at the bottom of the wall with a Tilath™ Starter Strip, placed over the weep screed, to assure proper ship-lapping. The Starter Strips are custom-made, 6-inch wide rolls of Grade D asphalt paper that have 1-inch incremental markings, to easily identify the location of the stud wall framing.

Laps: Minimum of 1" at edges with ends nested paper to paper, metal to metal. Apply the second sheet to the left of the first sheet lapping paper over paper and lath over lath. Place the third sheet centered above the first two sheets. This process is similar to that of laying brick. This staggers the vertical butt joint seams and allows a more uniform dispersal of stress.

On horizontal applications all nails shall be driven flush with base. On vertical applications nails shall be bent over to engage at least 3 strands of Diamond Mesh or through rib on rib lath and bridge ribs with staples.

Lath Fasteners (per ASTM C-1063)

Concrete/CMU: use (3/8" diameter shank, 3/4" minimum length). 6 power or powder actuated fasteners, 4 in the corners and 2 in the middle of long edge.

Wood framing: use 11 gauge 1-1/2" length, 7/16" head nails (roofing nails 6d, 1-1/2" x 1/4 head)

Sheathing over wood framing: use 14 gauge, 1" leg, 3/4" crown staples. Staples shall engage a minimum of 3 strands of lath.

Metal framing: use self drilling, self tapping #12 x 3/4" wafer head screws. The use of powder actuated or power actuated fasteners is acceptable, but may cause spalling when shot to the substrate; follow manufacturer's instructions carefully.

Insulated Concrete Forms (ICF): Consult specific ICF manufacturer.

Fastener Spacing

Spacing of nails, staples or screws is not more than 7" on center along the framing member (horizontal or vertical).

Concrete: 6 power actuated fasteners, 4 in corners, 1 on each side of long edge in center.

Span Limitations

Every finish material is subject to span limitations, which is the maximum distance between frame members. When sheathing is not required, 16" on center is the maximum spacing of framing to prevent undue sagging. Then minimum 2.5 lb. self-furring lath is installed over sheathing or solid surface, the maximum spacing of supports may be 24" on center.

*Note: Lath shall be furred away from vertical supports or solid surfaces at least 1/4". Self-furring lath (Dimpled, V Groove or High-Rib) lath meets these furring requirements. See chart "Support Spacing for Metal Lath" on page 3 (bottom) of this catalog for lath weight/type.

Cut and Trim to Fit

Standard sheet shears or metal cutting scissors are effectively used for notching and snipping. A conventional circular saw equipped with a metal cutting blade easily zips through steel lath to cut to desired lengths.

Wire Tie (0.0475", 18-gauge)

Lath is to be wire tied at 9" on center at edges, ends and at laps between framing members. On plywood sheathing only, lath may be nailed or stapled in lieu of tying at the same center spacing noted above.

Accessories

Corner beads shall be used to protect all external corners with a plumb and true edge. Casing beads shall be used to terminate stucco or stone around doors, windows or other openings.

Important Installation Note

Lath accessories are designed to make stucco and stone jobs easier, more efficient and provide the final product a more professional look. To ensure this, accessories should be attached every 7" o/c with nails, staples or tie wires. For control joint, corner and casing beads, the nose can be used as a screed for the stucco brown coat, but must be embedded by 1/8 inch thickness of plaster on the final coat. Be careful not to scrape galvanizing off the accessories.

Controlling Cracks

It is difficult to anticipate or prevent plaster cracks, but they can be largely controlled by means of expansion joints. The expansion joints should be installed between lath. The lath is to be broken underneath the expansion joint to function properly. Fasten the joints to the lath using info found under "Lath Fasteners" section.

Walls and ceilings that use metal lath for the plaster base should be divided into rectangular panels with control joint at least every 18 feet or at the juncture of a dissimilar wall, or in either direction in a length to width ratio of 2 1/2 to 1, or in ceilings exceeding 100 sq. ft. or walls exceeding 144 feet in area.

Control Joints shall be formed by installing a single piece Griplock J™ or #15 VV-Type accessory. Install the M-Slide™ 2-piece expansion joint where an expansion joint occurs in the exterior wall, or dissimilar substrates align next to each other. M-Slide Vertical is for vertical applications and M-Slide Horizontal is for horizontal applications used within floor-to-floor framing, etc.

INSTALLATION DETAIL PHOTOS

Attachment of Lath to studs

- 1) Wafer head screws are power driven to allow quick and easy attachment of Diamond Mesh Lath to framing members.
- 2) Diamond Mesh Lath can be cut to size with hand tools.

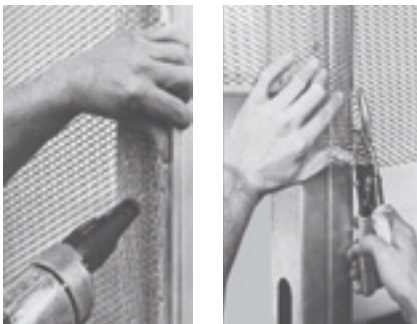

Attachment to solid surfaces

- 1) Self-Furred Diamond Mesh Lath is secured to masonry surfaces with hardened concrete nails and power driven fasteners at the furring dimples. Paper backed lath is often used in this type of application as a bond breaker.

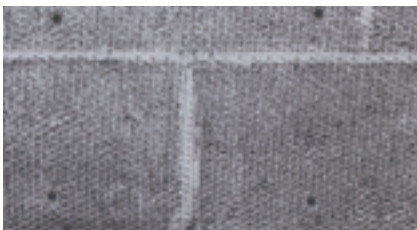

- 2) The scratch coat is applied with complete embedment of the self-furred lath in the plaster.



- 3) Scratch coat is fully embedded in the lath and is isolated from supporting structure. Water resistant backing paper allows controlled and uniform curing of this plaster foundation.

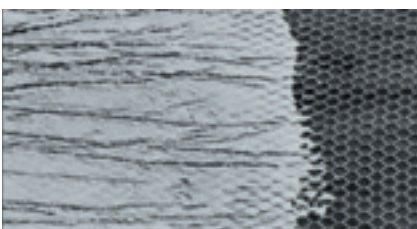

Attachment of Rib Lath to ceilings

- 1) High (3/8") Rib Lath is attached to ceiling joist, spaced at 24" o/c max. Flat Rib Lath can span up to 16" o/c.



Attachment of trims/joints

- 1) Type "M" Expansion Joint is installed vertically over the window opening allowing for expansion and contraction.



- 2) AMICO X-1 Corner Bead provides protection for outside corners and a reliable straight ground for screeding.

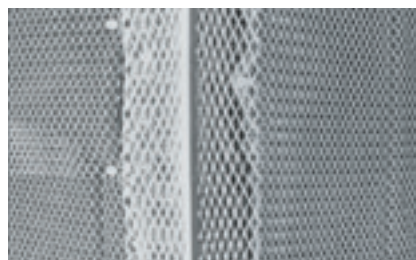

- 3) X-66 Expanded Casing Bead is typically installed at door and window openings as a plaster stop.



METAL LATH SPECIFICATION

Specification for Metal Lath and Accessories

Section 09100 – Lath and Plaster

Section 04420 – Exterior Stone Cladding

Part 1 General

1.1 SECTION INCLUDES

- A. All materials, equipment, supplies, to install expanded metal lath for portland cement plaster for [interior] [and] [exterior] applications required for this project.

1.2 REFERENCES

- A. ASTM C841 - Standard Specification for Installation of Interior Lathing and Furring
- B. ASTM C847 - Standard Specification for Metal Lath
- C. ASTM C926 – Standard Specification for Application of Portland Cement-Based Plaster
- D. ASTM C1063 - Standard Specification for Installation of Lathing and Furring for Portland Cement-Based Plaster
- E. International Building Code, Chapter 25.
- F. International Residential Code, Chapter 7.
- G. EMLA 920– Guide Specifications for Expanded Metal Lathing and Furring, (Expanded Metal Lath Association of NAAMM)

1.3 SUBMITTALS

- A. Metal lath submittal shall include the manufacturer's certification that the lath meets or exceeds the specified weight per ASTM C847. Provide manufacturer's product literature, ICC-ESR report, and LEED information prior to ordering.

1.4 STORAGE AND HANDLING

- A. All lath and accessories shall be protected from weather per ASTM C1063 prior to arrival and when stored on the job site.
- B. Do not store on end, or place materials on to of the lath.

Part 2 Products

2.1 MANUFACTURER

- A. Alabama Metal Industries Corporation, AMICO, 3245 Fayette Avenue, Birmingham, AL 35208; Telephone 800/366-2642; website www.amico-lath.com

2.2 METAL LATH

- A. Metal Lath for vertical surfaces [AMICO Flat Diamond Mesh] [AMICO Self-Furred Dimple Diamond Mesh] [AMICO Self-Furred V-Groove Diamond Mesh] lath. [2.5] [3.4] pounds per square yard.
- B. Metal Lath for horizontal surfaces [AMICO 1/8-inch Flat Rib] lath [2.75] [3.4] or [AMICO 3/8-inch High Rib] lath [3.4] [4.0] pounds per square yard. Metal Lath for high moisture applications stainless steel [grade 304] [grade 316] expanded metal [AMICO Diamond Mesh] [AMICO Self-Furred Dimple Diamond Mesh] for exterior plastering work [1.75] [2.5] [3.4] pounds per square yard.

- C. Paper Backed Spray for spray applied vertical surfaces [AMICO Paper Backed Spray Lath] [AMICO Paper Backed Spray Lath V-Rib lath] for spray applied stucco weighing not less than 3.4 pounds per square yard.
- D. Paper Backed Spray for spray applies horizontal surfaces [AMICO Paper Backed Spray Lath Flat 1/8-inch Rib lath] weighing not less than [2.75] [3.4] pounds per square yard.
- E. Paper Backed Lath for vertical surfaces [AMICO Tilath®] [AMICO Self-furred Dimpled Tilath®] [1.75][2.5][3.4] pounds per square yard with factory applied [20 minute] [60 minute] Grade D, style 2 asphalt saturated paper.
- F. Paper Backed Lath for horizontal surfaces [AMICO Tilath® Rib Lath (1/8-inch Rib)] [2.75] [3.4] pounds per square yard with factory applied 20 minute Grade D, style 2 asphalt saturated paper.

2.3 FASTENERS FOR LATH ATTACHMENT

- A. Lath shall be attached to [vertical] and or [horizontal] framing members spaced in accordance with ASTM C1063 Table 3. Fasteners; nails, screws or staples per ASTM C1063.

2.4 ACCESSORIES

A. General

- 1. Accessories shall be produced from [PVC/vinyl] [and or] [hot dip galvanized steel] [and or] [zinc alloy] [and or] [stainless steel] [Grade 304] [or] [Grade 316].
- 2. Accessory grounds shall be consistent with the plaster thickness.

- B. Stress and edge related reinforcement as noted on drawings
- C. Stress relief expansion and control joints as noted on drawings
- D. Moisture relief accessories as noted on drawings
- E. Architectural accessories as noted on drawings
- F. Fasteners for accessory attachment

- 1. Fasteners and their installation in accordance with [ASTM C1063 for exterior stucco work] [and] [or] [ASTM C841 for interior gypsum plaster work].
- 2. Any plaster or stucco installation requiring a combination of metal lathing materials that includes stainless steel shall utilize the appropriate fastener made from stainless steel.

2.5 MOISTURE BARRIER PAPER

- A. 2 layers of Grade D, Water-vapor permeable; Type 1 Barrier Paper; Style 2 paper [30 minute] [60 minute], per Federal Specification - UU-B-790a, UBC Standard 14-1 [or] [paper-backed AMICO Tilath® metal lath can be installed as one of the two layers of Grade D paper] [or] [pre-approved WRB, Weather Resistant Barrier equivalent].

Part 3 Execution

3.1 EXAMINATION

- A. Verify existing conditions before starting work.
- B. Verify the sheathing has a 1/8-inch gap on all edges of every sheet.
- C. Do not begin work unless all unsatisfactory conditions are resolved.

3.2 MOISTURE BARRIER

- A. Shingle the moisture barrier edges, overlapping 2 inches on all sides.
- B. Install with mechanical fasteners in a manner that secures the moisture barrier without more fasteners than required for the fastening pattern.

3.3 FASTENERS

- A. Lath installed over open wood framing utilizes 11GA x 1-1/2 inch long barbed shank x 7/16-inch diameter head roofing nails or galvanized 4d common nails.
- B. Open wood framing secure ends of lath sheets between framing members with open wood framing shall be fastened with 18GA (0.0475-inch) tie wire on 9-inches centers.
- C. Lath installed on sheathing over wood framing shall only utilize nails, screws or staples to join lath end joints using 14GA x 1-1/2 inch long staples with a 3/4-inch crown.
- D. Fasteners for lath shall be driven into the framing members 3/4-inch and engage at least three strands to secure the lath to the framing members.
- E. Spacing of nails, staples or screws shall be no more than 7 inches on center along the any framing member.
- F. Staples are not allowed for ceiling applications.
- G. Metal Framing applications shall utilize wafer head #12 shank x 3/4-inch self-tapping screws.
- H. Concrete / CMU use 6 each power actuated fasteners allowing 1-fastener in each corner and 1-fastener centered along the long dimension of the lath sheet.
- I. In horizontal applications all nails shall be driven flush with lath.
- J. Vertical applications, all nails shall be bent over to engage at least three strands of lath.
- K. Fasteners shall penetrate the ribs of rib lath and bridge rib laps with staples.
- L. Refer to ASTM 1063 for other lath attachment conditions.

3.4 LATH INSTALLATION TO HORIZONTAL SURFACES

Ceilings constructed with gypsum plaster and larger than 2,500 square feet in area or with any dimension exceeding 50 feet must be unrestrained.

Ceilings constructed with portland cement-based plaster must be unrestrained.

Isolate ceiling lath and plaster from ceiling intersecting vertical surfaces with casing beads, control joints, or similar designs to keep the ceiling isolated from the adjacent vertical surfaces (walls, partitions, beams, and columns).

Do not use corner reinforcement at the internal angle between the ceiling and the vertical surfaces.

3.5 INSTALLATION OF ACCESSORIES

A. General

1. Install accessories prior to the lath in a straight and square manner and to separate structural from non-structural elements such as door and window openings.
2. Accessories to be installed on top of the moisture barrier; foundation weep screed is installed under the top layer of moisture barrier.
3. It is recommended to install vertical running accessories continuously and horizontally running accessories to break or butt at vertical accessories.
4. When butting accessories do not overlap. All joints should be embedded in sealant.

B. Control Joints

1. Control joints shall be formed by using a single prefabricated member with the metal lath terminating and wire tied to the top of the flange portion to permit movement. Lath is to be broken at all control joints and shall be stopped and wire tied at each side.
2. Control joints shall be installed in walls to define areas not more than 144 square feet and areas in ceilings not more than 100 square feet with a maximum distance between control joints not to exceed 18 lineal feet or a ration of length to width of 2½:1.
3. The accessories should be set in sealant prior to stucco application; control joints to be set into a bed of sealant. The sealant shall be applied at all exterior corners, all interior corners, all butt ends, i.e., all joints in the metal lath.

C. Expansion Joints

1. Expansion Joints – 2-piece Joints to be applied to bridge dissimilar surfaces and across expansion joints in the structure.
2. Fasten the expansion joint to each side of the dissimilar or broken substrate, then apply lath over the flanges of the expansion joint and wire tied at each side.
3. Follow fastening spacing outlined in ASTM C1063 at not greater than 7 inches on center.

SPECIALTY METAL PRODUCTS

N093 Drywall/DEFS Control Joint is similar to the control joint for veneer finish drywall installations or DEFS applications. It is produced in **zinc alloy only** and comes with a removable tape across the joint to keep joint clean during installation.

Grounds	Length	Pieces/carton	Weight/carton	Cartons/pallet	Pallet weight
3/32"	10'	25	27 lbs.	20	540 lbs.

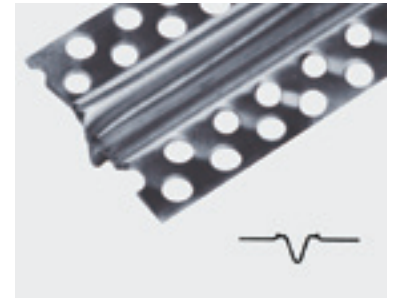
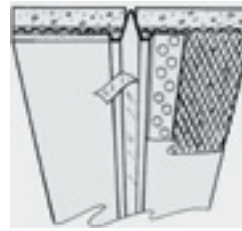

Wire Corners provide for rounder corners, embedding all reinforcement. They are manufactured from zinc coated wire, electronically wired to form the corners. Bullnose, arch and short flange configurations come standard in 10' lengths, but are also available in 8' and 9' lengths. They are packaged 40 pieces per carton with 24 cartons per pallet.

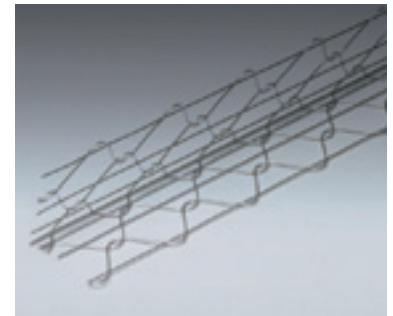

Style	Flange size	Weight/carton	Style	Flange size	Weight/carton
Straight	2.5" x 2.5"	48.0 lbs	Bullnose	2.5" x 2.5"	48.0 lbs
Straight BN (7/8")	2.5" x 2.5"	36.8 lbs	Bullnose short	2.5" x 1.5"	40.0 lbs
Straight 2-wire	2.5" x 2.5"	49.4 lbs	Bullnose 2-wire	2.5" x 2.5"	49.4 lbs
Arch	2.5" x 2.5"	34.0 lbs	Short Flange	2.5" x 1.5"	48.0 lbs
Arch BN	2.5" x 1.5"	34.0 lbs	Short Flange BN (7/8")	2.5" x 1.5"	40.0 lbs

Galvanized Hanger and Tie Wire are used to support CRC gridwork for stucco and acoustical or drywall ceilings. Hanger wire is produced in #8, #9 and #12 gauge galvanized soft annealed steel in 12' lengths. Tie wire is produced in #16 and #18 gauge galvanized soft annealed steel in 28" lengths.

Product	Gauges	Length	Weight/package
Hanger Wire	8, 9, 12	12'	50 lb. hanks
Tie Wire	16, 18	28"	25 lb. hanks

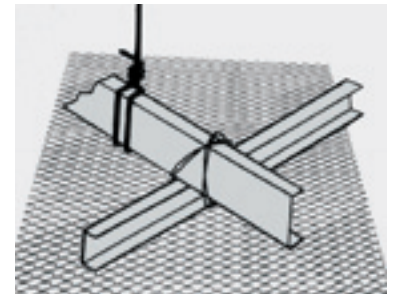

Galvanized Cold Rolled Channel is used to form suspended ceiling grids for lath and plaster applications and for horizontal bridging in steel framing.

Size	Pieces/bundle	Weight/16' piece	Weight/20' piece	Weight/bundle (16')	Weight/bundle (20')
3/4"	20	4.9 lbs.	6.1 lbs.	98 lbs.	122 lbs.
1 1/2"	20	7.7 lbs.	9.6 lbs.	154 lbs.	192 lbs.

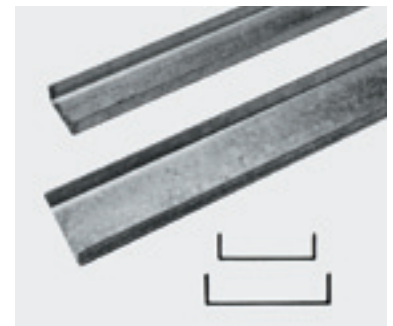

Alloy SS304 provides excellent corrosion resistance for specialty lath applications. SS304 Lath can be used over sheathing boards to carry conventional stucco/stone finishes and for external insulation requirements. SS304 Lath is used in coastal environments, near water, where underspray, fireproofing or corrosion protection is desired. **Produced both flat and self-furred (Dimpled).**

Alloy SS316 is used for extreme corrosive environments, around chlorine or pool splash-zones or construction of rock and water formations. It is also a good choice for water and wastewater treatment facilities, high-temperature installations and petrochemical fireproofing. **Produced both flat and self-furred (Dimpled).**

Weight/sq. yard	Alloy	Sheet weight	Nominal sheet size	Sheets/bundle
1.75 lbs.	304 or 316	approx. 3.5 lbs.	27" x 97"	10
2.5 lbs.	304 or 316	approx. 5.00 lbs.	27" x 97"	10
3.4 lbs.	304 or 316	approx. 6.80 lbs.	27" x 97"	10

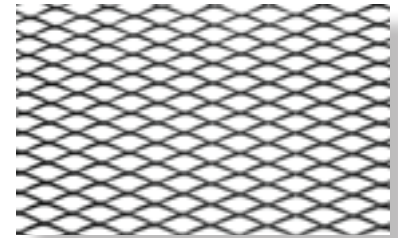
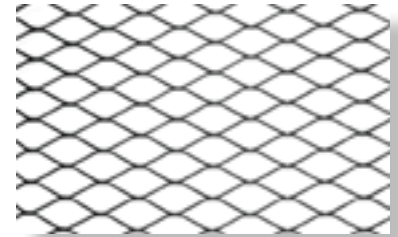

Stainless Steel Lath is not in all AMICO distribution centers. Contact AMICO for availability and shipping.

SECURA LATH® SPEC DATA

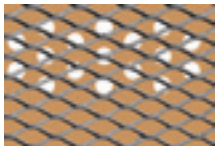

Section 09 22 00
Secura Lath Ceiling Penetration
Barrier Meets "Buy American"
Procurement

Finish	Sheet Size	Panel Size	Weight Per Sq. Ft.
Pre-Galvanized	27" x 97"	18.2 sq. ft.	.83 lbs.

Part 1 General

1.1 SECTION INCLUDES

A. Supply and install all materials required for a complete in-place security lath structural base for Portland cement stucco or high strength gypsum plaster and all complimentary accessories.

1.3 REFERENCES

- A. ASTM A1011 Standard Specification for Steel
- B. ASTM F1267 Standard Specification for Metal, Expanded, Steel
- C. AMICO Secura Lath Installation Guidelines

1.4 QUALITY ASSURANCE

A. The contractor must have documented experience with the construction methods involved with plaster and stucco installations on ceilings.

Part 2 Products

2.1 MANUFACTURER

A. Physical penetration barrier for plaster applications shall conform to ASL .50-16R as manufactured and specified by Alabama Metal Industries Corporation (AMICO), Birmingham, AL; Telephone 205/783-9515; www.amicosecurityproducts.com/lath.htm

2.2 MATERIALS

A. The security lathing system shall comply with AMICO ASL .50-16R Secura Lath.

2.3 FINISH

- A. Pre-Galvanized Finish – for standard installations lathing mesh shall be pregalvanized prior to expanding and the factory applied paper backing.
- B. Perforated Kraft paper shall be vinyl coated one side and factory attached to the metal lathing.

Part 3 Execution

3.1 INSTALLATION

- A. Installation and lay-out of the job shall be approved by the owner or general contractor prior to installation.
- B. Recommended perimeter detailing for intersections can be found on AMICO's website.

SECURITY MESH™ SYSTEM

AMICO Security Mesh™ is a steel mesh panel used as a penetration barrier behind drywall finishes. Security Mesh (ASM) is attached to metal or wood framing members in walls and ceilings using AMICO Secura Clips™ in lieu of washers or welding to stud framing.

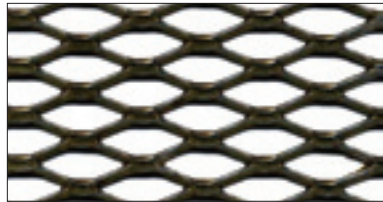

ASM .50-13F
Maximum Security



ASM .75-9F
Maximum Security



ASM .75-13F
Medium Security



ASM 1.5-9F
Medium Security



ASM 1.0-16F
Minimum Security



ASM .75-9F Heavy Modified
Super Max Security for Industrial and Homeland Security applications

Specified and Approved by Federal Agencies for new and retrofit applications.

AMICO Security Mesh	Weight per sq. ft.	Overall Thickness	Percent Open Area
ASM .50-13F	1.40 lbs.	.070"	57%
ASM .75-9F	1.71 lbs.	.120"	63%
ASM .75-13F	.75 lbs.	.070"	73%
ASM 1.5-9F	1.11 lbs.	.110"	77%
ASM 1.0-16F*	.41 lbs.	.048"	77%
ASM .75-9F (Max)	2.38 lbs.	.140"	63%

Tolerances: SWD = 0 + 1/4" per foot of dimension
LWD = 0 + 1/4" per foot of dimension

Stock sizes: 4' x 8' 5' x 8' 6' x 8'
 4' x 10' 5' x 10' 6' x 10'

*4' x 8' panels only

AMICO Secura Clips™ make any installation more secure by improving the holding power over standard drywall screws by 68%. Attach clips at a minimum of 12" on center per framing member. Panels may be staggered or butted, but must join on a framing member. Secura Clips are shipped 300 clips per carton. (You will need 24 clips per 4' x 8' ASM panel.)

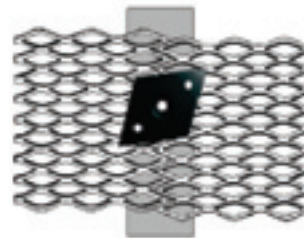

Panels Butted and Staggered

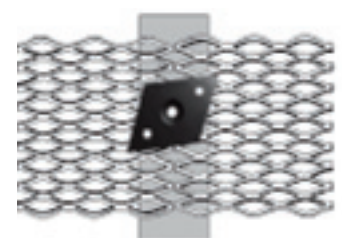

Panels Butted

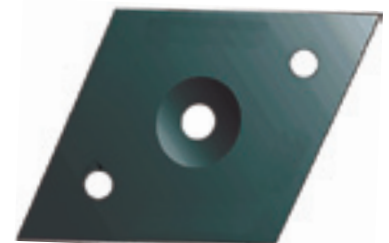

SECURITY MESH™ SPECIFICATION

Section 09 29 00

Drywall Penetration Barrier

Security Mesh

Meets “Buy American” Procurement

Part 1 General

1.1 SECTION INCLUDES

- A. Supply and install steel expanded metal panels as a penetration barrier behind gypsum [wall] and or [ceilings] using the Secura Clips.

1.2 SYSTEM DESCRIPTION

- A. Security Mesh shall be made from a sheet of steel that is simultaneously slit and stretched into a rigid, open mesh diamond making one continuous sheet that cannot unravel. The finished shape of the mesh openings shall be a flattened diamond. Conventional expanded metal not manufactured specifically for security purposes is NOT acceptable for this use.

1.3 REFERENCES

- A. ASTM A1011 Standard Specification for Steel, Sheet and Strip, Hot-Rolled, Carbon, Structural, High Strength Low Alloy, High-Strength Low-Alloy with Improved Formability, and Ultra-High Strength
- B. ASTM F1267 Standard Specification for Metal, Expanded, Steel
- C. ASTM A123 Standard Specification for Zinc (Hot-Dip Galvanized) Coatings on Iron and Steel Products

1.4 QUALITY ASSURANCE

- A. Materials shall meet the requirements of “Buy American” domestic requirements.

1.5 SUBMITTAL

- A. Letter Underwriters Laboratories Fire Rated Assemblies letter; (per U/L subject File #1857). The use of Security Mesh will not jeopardize a fire rated assembly.

1.6 STORAGE AND HANDLING

- A. Materials shall be protected from damage by weather, vandalism, and theft.

Part 2 Products

2.1 MANUFACTURER

- A. The behind the drywall penetration barrier system shall conform to Security Mesh™ for installation in [walls] [and] [ceilings] using Secura Clips as manufactured by ALABAMA METAL INDUSTRIES CORPORATION, (AMICO), 3245 Fayette Avenue; Birmingham, AL 35208; Telephone 205/783-9515.

2.2 PANEL STYLE - Select and delete unused styles

- A. Maximum Security - ASM .75–9F, ASM .50–13F, and ASM .75–9F Heavy
- B. Medium Security - ASM 1.5–9F and ASM .75–13F
- C. Minimum Security - ASM .75–16F and ASM 1.0–16F

2.3 AMICO SECURA CLIPS

- A. Security Mesh shall be attached to framing members using AMICO Secura Clips and the appropriate threaded fasteners.
- B. For steel framing install a flat head bugle type self-tapping fine thread screw long enough to penetrate the framing member a minimum of 3/8-inch.
- C. For wood framing applications install a 1-5/8-inch fine thread drywall screw allowing the fastener to penetrate the framing member at least 1-1/4 inches.
- D. Secura Clip spacing shall be a minimum of [12] [6] inches vertically per framing member.
- E. In ceiling applications Secura Clips shall be spaced a minimum of [12] [6] inches along ceiling joists.

2.4 FINISH

- A. Security Mesh is supplied “mill finish” HR P&O.
- B. Security Mesh with hot dip galvanized finish.

Part 3 Execution

3.1 PREPARATION

- A. Installation and layout of the job shall be approved by the owner or general contractor prior to installation.
- B. It is recommended framing members be no less than 20GA.

3.2 INSTALLATION

- A. Security Mesh panels may be installed with diamonds running in either direction.
- B. Panels are flattened by a rolling process and panels are not square. Manufacturing tolerances are to be considered.
- C. AMICO Secura Clips shall be installed to secure the mesh to the framing members prior to the installation of drywall finish.
- D. Mesh joints occurring on framing members may either join staggered or butt together. It is acceptable to overlap mesh joints with owner’s approval.
- E. Panels shall join, begin and terminate on a framing member. Panels not joining on framing member shall be wire tied with 18GA steel tie wire. Wire tying shall be no less frequent than the installation of Secura Clips.

3.3 CLEANING

- A. The contractor shall be responsible to clean up the jobsite of any unused materials and trash.

Manufacturing & Distribution:

Birmingham, AL
800-366-2642
fax 205-780-7838

Fontana, CA
800-962-0100
fax 909-822-8135

Denver, CO
800-962-0100
fax 909-822-8135

Wilmington, DE
800-476-4430
fax 302-429-9126

Lakeland, FL
800-487-2511
fax 863-688-2242

Chicago, IL
800-238-0322
fax 815-932-4557

Greenville, SC
800-476-4430
fax 864-458-7245

Houston, TX
800-433-9945
fax 713-921-5636

Orem, UT
800-645-0340
fax 801-226-3066

Seattle, WA
800-859-5363
fax 253-872-5676

Montreal, Canada
800-361-0009
fax 514-648-4731

Toronto, Canada
800-663-4474
fax 905-335-5682

Vancouver, Canada
800-665-4474
fax 604-607-5075



Visit www.amico-lath.com to view or download data sheets, request a catalog, request LEED information or find an AMICO representative to contact for technical assistance.