

5.8GHz Audio/Video Sender

CE 0336!

R&TTE – Code: VS5811T

FCC ID: QWTVS5811T

FCC ID: QWTVS5811R

Design and specification subject to change without notice.



1. Important Safety Information

Contents

1. Important Safety Information	1
2. Package Content	2
3. Panel Control and Function	3
4. Setup Guide	5
5. Orient Transmitter/Receiver for optimal performance.....	6

1. Important Safety Information

To prevent fire or shock hazard, do not expose this product to rain and moisture. For example: do not use near a bathtub, washbowl, kitchen sink, or laundry tub, in a wet basement, or nearby a swimming pool. To avoid electric shock, do not take apart this product, provided as an accessory. This product should be operated only under power supply. Do not overload wall outlets and extension outlets as this can result in the risk of fire or electric shock.

NOTE:

This equipment has been tested and found to comply with the limits regulated by FCC and CE. These limits are designed to provide reasonable protection against harmful interference in a residential installation. This equipment generates, uses and can radiate radio frequency energy and, if not installed and used in accordance with the instruction, may cause harmful interference to radio communications. The change or modifications no expressly approved by the party responsible for compliance could void the user's authority to operate the equipment. To comply with the FCC RF exposure compliance requirements, no change to the antenna or the device is permitted. Any change to the antenna or the device could result in the device exceeding the RF exposure requirements and void user's authority to operate the device.

2. Package Content

Check to make sure that all units shown as below are enclosed. If something missed, please contact your dealer. 1

1. 5.8GHz Transmitter x 1



2. 5.8GHz Receiver x 1



UHF: 433.92MHz (European)

UHF: 418MHz (USA Standard)

3. IR Mouse x 1 / fasten strips x 2



4. Accessories

European Standard:

(1) Power Adapters (230V) x 2 (2) RCA to Scart cable x 2



USA Standard

(1) Power Adapters (120V) x 2 (2) RCA Cable x 2



5.8GHz Transmitter

Orients the UHF Antennas

In order to obtain optimal performance of the remote control extender, the remote control extender, the remote control antennas should also be oriented at a right angle to an imaginary line drawn between the transmitter and receiver units. If your remote control extender is not working satisfactorily, rotate the remote control antenna on either the transmitter or receiver 90 degrees so that it is still perpendicular to the path between the units. (See Fig-4)

If you notice improved performance, keep this orientation. Rotating the antenna on both units should have no effect.

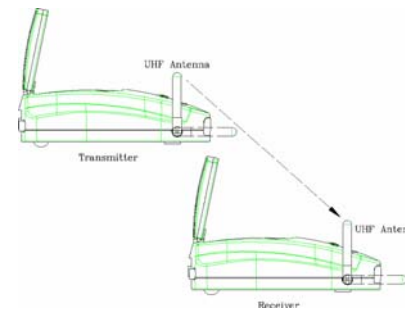

Fig-4

5. Orient Transmitter/Receiver for optimal performance

For optimal performance, both the audio/video and remote control antennas should be carefully oriented as described below. For maximum transmitting range, try to minimize obstacles (e.g. your TV or other electronics, large furniture) where between the transmitter and receiver.

Orients the 5.8GHz A/V Antennas

The systems deliver high-quality audio and video by using directional antennas, which must be oriented in the best ways. The antennas are designed to be able to vertically and horizontally pivot and rotate in almost any direction.

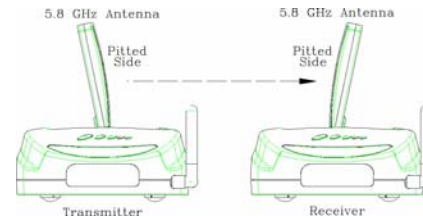

Fig-1

In most situations, the flat-pitted face of the antennas on both the transmitter and receiver should be facing one another and perpendicular (at a right angle) to an imaginary line drawn between the two units. Three examples are shown as Fig-1, Fig-2 and Fig-3. Since all homes are different, for optimal reception, additional slight pivots or rotations may be necessary. If the transmitter and receiver are less than 10 feet apart, suggest that the antennas are lying on their casings since the distance is so short.

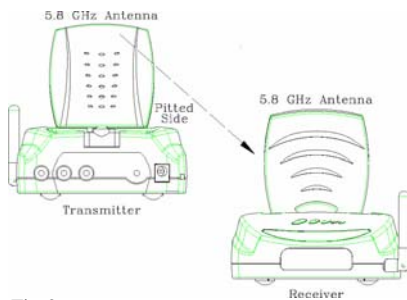

Fig-2

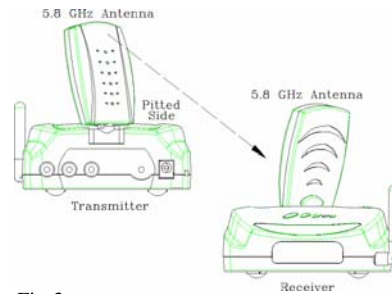

Fig-3

3. Panel Control and Function

5.8GHz Transmitter



5.8GHz Receiver

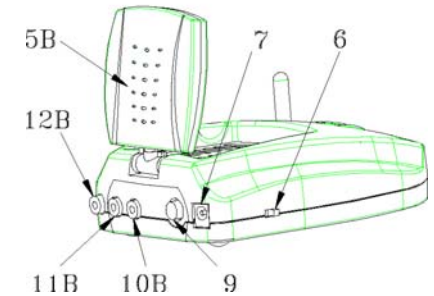
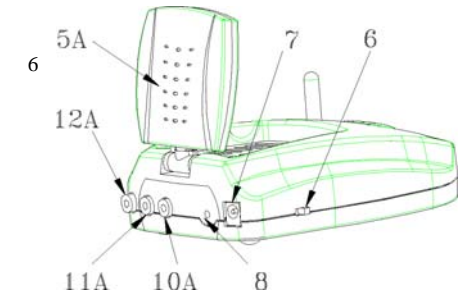
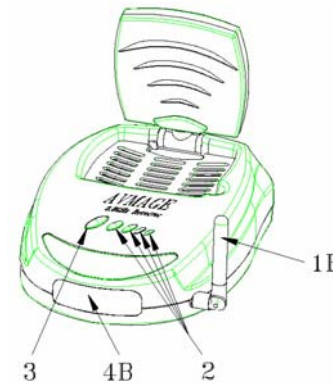

1A – UHF antenna receives remote control signal.

1B – UHF antenna sends remote control signal.

2 – Indicator lights show the channel it configured as.

3 – Channel selection button to find optimal reception, the transmitter and receiver must to be Configured as the same channel.

4. Setup Guide

- 4A – Remote control window sends IR rays, to remotely control the source AV equipment.
- 4B – Remote control window receives IR rays from remote controller.
- 5A – Directional 5.8GHz A/V antenna sends A/V signal from source equipment.
- 5B – Directional 5.8GHz A/V antenna receives ³ audio and video signal.
- 6 – Power on/off switch.
- 7 – DC power input, connect to power supply. (12v).
- 8 – IR Mouse output, to remotely control source AV equipment.
- 9 – IEC jack (or F jack, USA Standard), output to TV.
- 10A– Video Jack, (yellow), input from source AV equipment.
- 10B– Video Jack, (yellow), output to TV.
- 11A– Audio Jack, Right (red), input from source AV equipment.
- 11B– Audio Jack, Right (red), output to TV.
- 12A– Audio Jack, Left (white), input from source AV equipment.
- 12B– Audio Jack, Left (white), output to TV.

To enjoy a life of wireless video and audio, just connect the transmitter to whatever A/V source you like and connect the receiver to a TV, monitor or speaker in another location.

NOTE: Make sure the ON/OFF switch is in the 「OFF」 position before connection

Transmitter

1. Connect one end of the RCA cable (or scart cable) to the audio and video jacks, and connect the other end to a source device as well.
2. Connect the DC plug of the adapter to the DC jack, and connect the power supply to an outlet.
3. Keep the IR window oriented toward the source AV equipment, or alternatively use the IR Mouse to remotely control it.

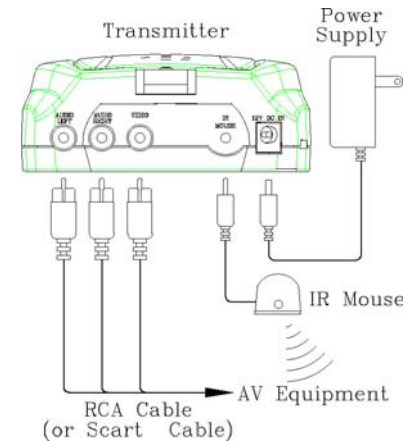

Receiver

1. Connect one end of the RCA cable (or scart cable) to the audio and video jacks and connect the other end to a TV (or monitor, speakers) on which you like to enjoy a program.
2. Connect the DC plug of the adapter to the DC jack, and connect the power supply to an outlet.
3. Keep the IR window oriented toward your remote controller.

