

ASSEMBLY INSTRUCTIONS

KAMPAR WOVEN DAY BED WITH DRAWERS

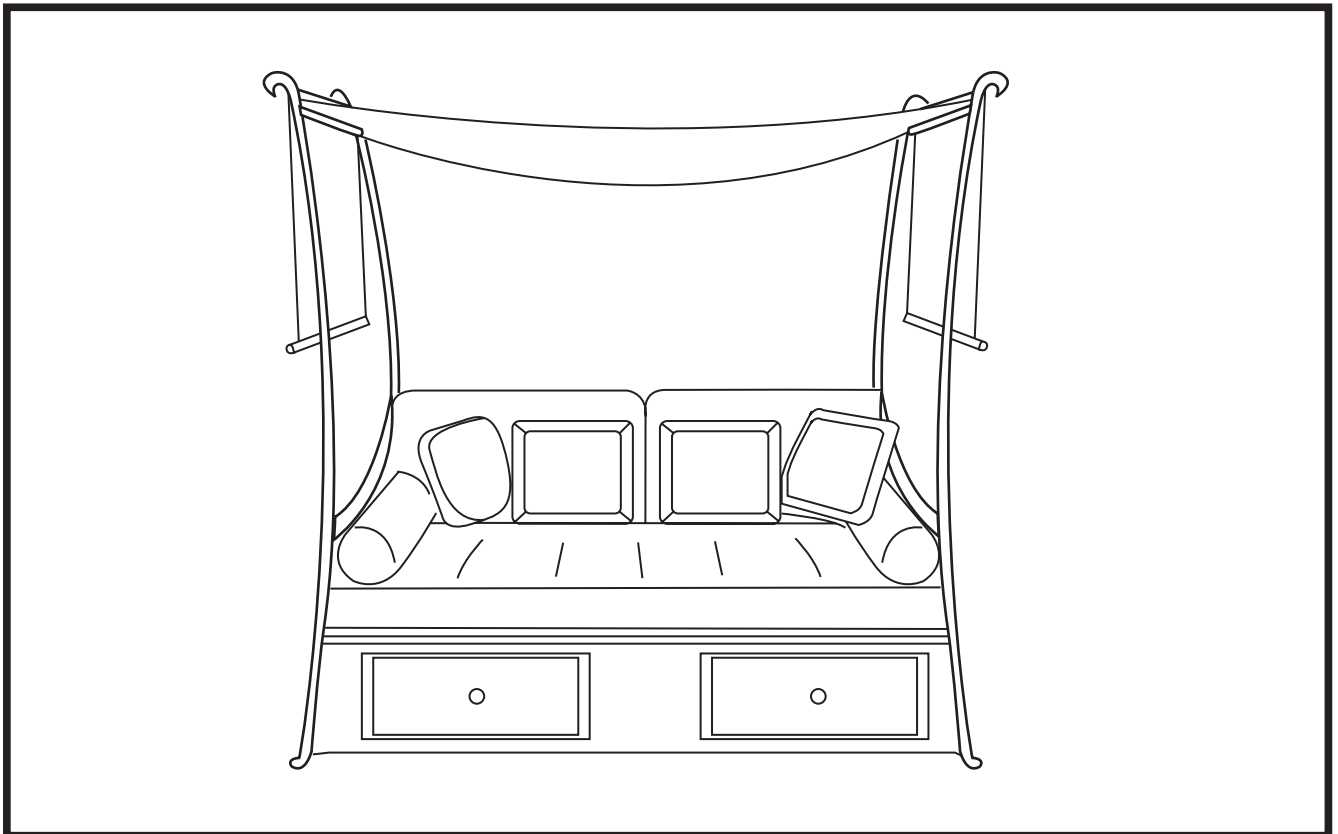

If you have any problems with this product, DO NOT RETURN IT TO

THE STORE. CALL OUR CUSTOMER SERVICE HOT-LINE at

(800)-279-1736,

8am - 8pm (EST), Monday - Friday.

Warranty

All Structural Frames Produced from both Cast and / or Tubular Aluminum, Steel, and Wrought Iron

- (7) Year Limited Warranty

All furniture manufactured and sold by BJI, Inc is warranted to the original purchaser against defects in workmanship and materials. If a product manufactured by BJI, Inc. fails during the first year from date of purchase under the terms of our limited warranty, BJI, Inc. will replace the item at no charge. After (1) year it will be the original purchasers, responsibility to pay for freight and packaging. BJI, Inc. reserves the right, in the case of discontinued or out of production models, to replace with an item of similar quality and style. (Glass breakage is not warranted)

Note: You must retain original receipt to obtain warranty!

Frames: Limited 7 Year

Frames are warranted against defects in materials and workmanship for a period of seven years from the date of original purchase. Damage to frames or welds due to commercial use, improper assembly, exposure to water and sub-freezing temperatures, and/ or abuse is not covered. (Please refer to care and maintenance information for proper cleaning instructions)

NOTE: (Steel & Wrought Iron are not covered against rust)

FABRIC: (1) Year if applicable

Fabric on cushions, slings, and umbrellas is warranted against separation at the seams for a period of (1) year. Fading, mildew, and/ discoloration due to exposure to elements, chemicals, and spills is not covered. (Please refer to care and maintenance information for proper cleaning instructions)

Powder Coat and/or Paint: (1) Year

The finish is warranted against blistering, peeling, or cracking for a period of one year. Fading resulting from exposure to elements, chemicals, and spills are not covered. Scratches and chips due to normal wear and use are not covered. (Please refer to care & maintenance information for proper cleaning instructions)

Resin Wicker Weave and/ or Vinyl Strap: (1) Year

Weave and/ or straps are warranted against breakage, separation, or tearing for one year. Fading or discoloration due to exposure from chemicals, spills, and/ or the elements is not covered. (Please refer to care & maintenance for proper cleaning instructions.)

Umbrella: (1) Year if applicable

Umbrella frames are warranted for one year against manufacturer's defects in workmanship and materials. Umbrella bases are not covered. (Please refer to care & maintenance instructions for proper cleaning information).

Freight & Packaging: (1) Year

BJI, Inc. will be responsible for shipping, handling, and packaging charges for the first year for all valid warranty claims. These charges are the sole responsibility of the claimant after the first year. Shipping is limited to USA, Mexico, & Canada only.

Care & Maintenance:

Be careful to never allow water to build up in frames as this will cause corrosion and freeze damage in cold climates. Wash all frames with a solution of mild soap and water. Rinse with clean water and dry with a soft absorbent cloth towel. Frames can be treated with a liquid wax for maximum protection against UV rays and/ or salty damp air. If your set includes cushions, slings, and/ or an umbrella they may be cleaned by hand with a solution of soap & water with a clean water rinse. (Never machine wash cushions, slings, or umbrella covers as

this will result in shrinkage or damage.)

After cleaning cushions tip on end and allow to drip dry. (Never use a commercial or home dryer to tumble dry fabric goods)

Do not use bleach or solvents to clean any product! This will void the warranty.

Exclusions:

Products used for commercial, contract, or any other non-residential purposes. Furniture sold “as is”, display models and/ or clearance items.

Freight damage, damage due to acts of nature, fire, abuse, vandalism, lack of proper care and maintenance. Glass breakage, table top damage, hardware against corrosion & rust, freeze damage, and improper assembly are not covered or warranted. In addition, fading cushions, slings, umbrellas, and coatings. We reserve the right to substitute similar quality and style merchandise / furniture if the model in question is out of stock or production rust and corrosion and rust stains.

Lack of original receipt will void warranty!

Customer Service: Monday - Friday 8:00a.m. - 8:00p.m. EST

By FAX: 502-410-0702

By Phone: 800-279-1736

Address: 2700 Stanley Gault Parkway, Suite 130, Louisville, KY 40223

CAUTION: Read all the instructions before assembly. Failure to do so may result in faulty assembly and potential injury!

SPECIAL WARNINGS

Assemble the item on a soft, non-abrasive surface, such as carpet or cardboard to avoid damaging the item. Seek assistance to assemble bulky or heavy items. After final alignment, make sure all bolts, nuts and nut covers are securely tightened.

Note: Identify all parts packed in carton against the parts list. Remove all the protective material carefully and DO NOT use a knife to prevent scratching the furniture. Do not tighten screws until product is completely assembled. At least 3 people are needed in the whole assembly process.

Step 1. Carefully align the side panels (A) with back woven panel (C) by using 4 hex head screw M6 x 25mm (I) and stainless steel washers (J) with hex wrench (K).

(Figure 1)

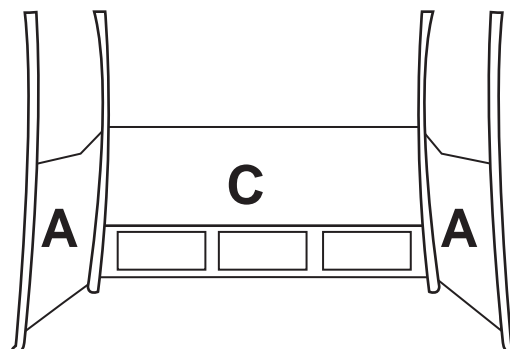

Figure 1

Step 2. Align the front woven panel (B) with side panels (A) by using 4 hex head screw M6 x 25mm (I) and stainless steel washers (J) with hex wrench (K).

(Figure 2)

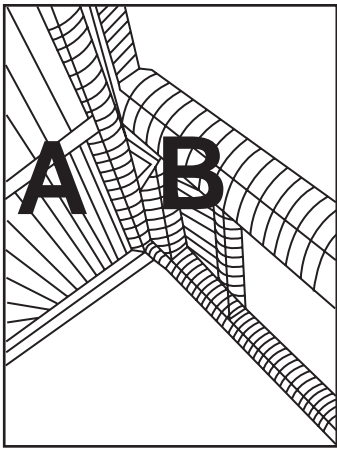

Figure 2

Step 3. Between the back woven panel (C) and front woven panel (B) lower tubes, you need connect 4 drawer supporting bars (E) using 16 hex head screw M6 x 25mm (I) and stainless steel washers (J) with hex wrench (K).

Please note that among 4 draw supporting bars (E) there are 2 kinds of drawer supporting bars marked “1” and “2” in the front, with 2 pieces each.

Please make sure your assembling as figure 3 shown.

(Figure 3)

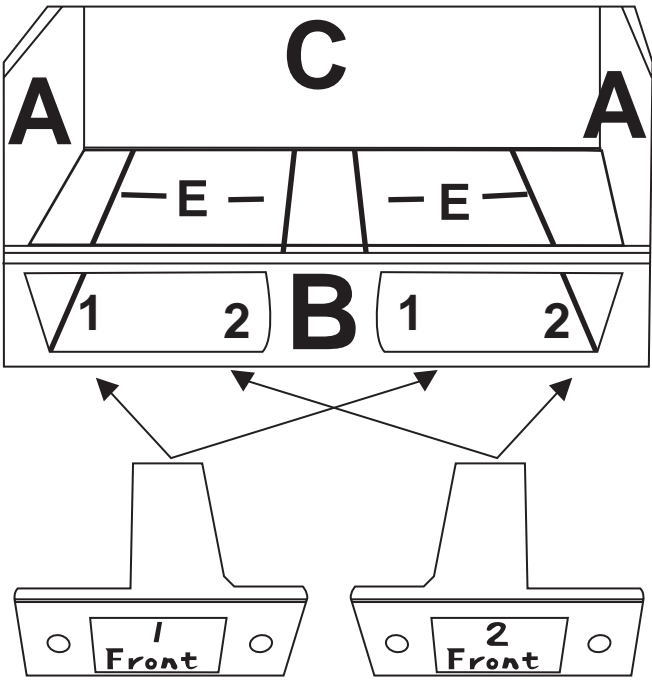

Figure 3

Step 4. Connecting the front woven panel (B) with back woven panel (C) by attaching 3 bed supporting bars (F) above the drawer supporting bar (E). Secure with 12 hex head screw M6 x 25mm (I) and stainless steel washers (J) with hex wrench(K).

(Figure 4)

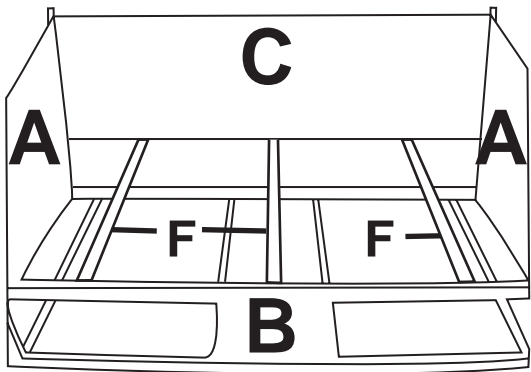

Figure 4

Step 5.

Check all the alignment and tighten all screws with hex wrench. Then cover all screws with hex head screw covers(N).

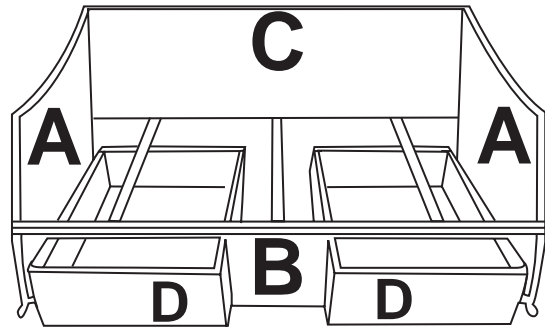

Figure 5

Step 6. Inset the drawers (D) along the woven drawer supporting bars (E).

(Figure 5)

Place the bed mesh top (H) on the bed supporting bars (F).

(Figure 6)

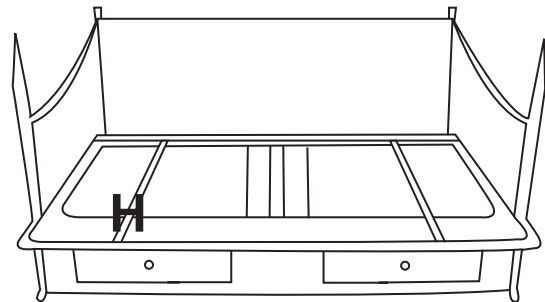

Figure 6

Step 7. Place cushions and pillows (L) on the bed mesh top (H).

(Figure 7)

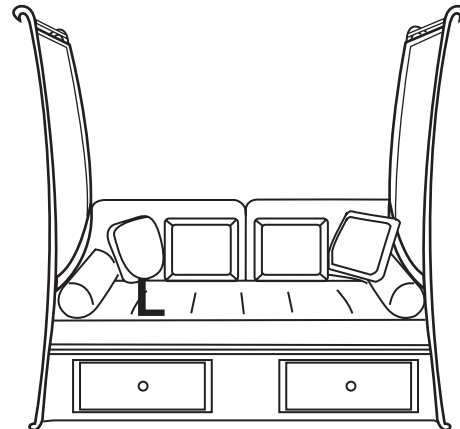

Figure 7

Step 8. Put canopy fabric (M) through the gaps of both top tubes of the side woven panels (A). Then inset the canopy bars(G) on both sides of the canopy.

Your woven bed is now ready to use.

(Figure 8)

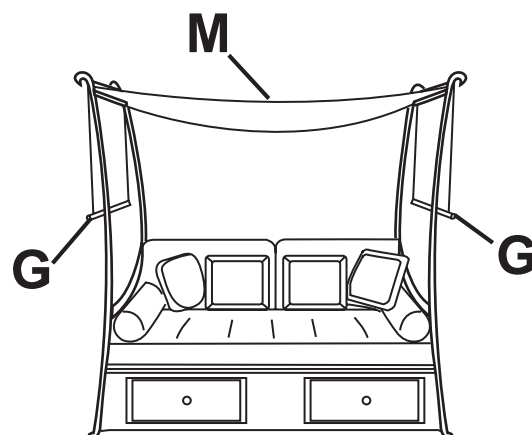



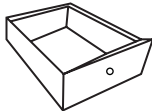

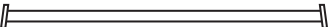



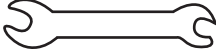
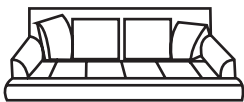



Figure 8

PARTS LIST

PART#	DESCRIPTION	PICTURE	QTY
A	Side Woven Panel		2
B	Front Woven Panel		1
C	Back Woven Panel		1
D	Drawer		2
E	Drawer Supporting Bar		4
F	Bed Supporting Bar		3
G	Canopy Bar		2
H	Bed Mesh Top		1
I	Hex Head Screw M6 x 25mm		36
J	Stainless Steel M6 Washer		36
K	Hex Wrench		1
L	Bed Cushions and Pillows		1
M	Canopy Fabric		1
N	Hex Head Screw Cover		36