



# Combination Primary and Backup Sump Pump System

## Instruction Manual & Safety Warnings

### Table of Contents

#### Important Safety Warnings and Instructions

Electrical precautions	1
Battery preparation	1
Battery precautions	1

#### Introduction

Items included in system	2
Additional items needed	2
System specifications	2

#### Installing the Pipe and Pump

3

#### Preparing the Battery

4,5

#### Battery Instructions

5

#### System Connections

Mounting the backup control unit	5
Connecting the backup pump	5
Installing the battery fluid sensor	5
Connecting the battery	6
Connecting the charger	6
Connecting the primary pump	6

#### Product Operation

6

#### Understanding the Warning Lights and Alarms

Silencing the alarm during an emergency	6
Power alarm	7
Water alarm	7
Backup pump alarm	7
Replacing the backup pump	8
Replacing the primary pump	8
Charger	9
Battery alarm	9
Cleaning battery terminals	10
Replacing the battery	10

#### Testing the System

Testing the pump	11
Testing the float switch	11

#### Parts & Service Information

Technical support	11
-------------------	----

#### Replacement Parts Diagram & List

14

#### Troubleshooting Guide

13

#### Warranty

14



**IMPORTANT:** Even if you have the Basement Watchdog sump pump system installed by someone else, you must read and follow the safety information contained in this manual. Failure to do so could result in property damage, serious injury, or death.

## Important Safety Warnings & Instructions

**SAVE THESE INSTRUCTIONS.** This manual contains important SAFETY WARNINGS and OPERATING INSTRUCTIONS for the Basement Watchdog combination sump pump system. You will need to refer to it before attempting any installation or maintenance. **ALWAYS** keep these instructions with the unit so that they will be easily accessible.

Failure to read and follow these warnings and instructions could result in property damage, serious injury, or death. It is important to read this manual, even if you did not install the Basement Watchdog combination sump pump, since this manual contains safety information regarding the use and maintenance of this product. **DO NOT DISCARD THIS MANUAL.**

### ELECTRICAL PRECAUTIONS

#### **⚠ DANGER**

**Risk of electrical shock and fire hazard. May result in death serious injury, shock or burns. To help reduce these risks, observe the following precautions:**

- **DO NOT** walk on wet areas of the basement until all power has been turned off. If the main power supply is in a wet basement, call an electrician.
- **ALWAYS** disconnect the pump from the power source before servicing or making adjustments.
- **ALWAYS** unplug the control unit and disconnect the cables from the battery before attempting any maintenance or cleaning.
- **NEVER** handle the pump or motor with wet hands or when standing on a wet or damp surface while the pump is plugged into the power source.
- **MAKE SURE THERE IS A PROPERLY GROUNDED RECEPTACLE AVAILABLE.** This pump is wired with a 3-prong grounded plug. To reduce the risk of electric shock, be certain that it is only connected to a properly grounded 3-prong receptacle (preferably with ground fault circuit interrupt). If you have a

2-prong receptacle, have a licensed electrician replace it with a 3-prong receptacle according to local codes and ordinances.

- **NEVER** bypass grounding wires or remove the ground prong from the plug.
- **DO NOT** use an extension cord. The electrical outlet should be within the length of the pump's power cord, and at least 4 feet above the floor level to minimize potential hazards from flood conditions.
- **DO** protect the electrical cord from sharp objects, hot surfaces, oil and chemicals. Avoid kinking the cord.
- **MAKE SURE** the supply circuit has a fuse or circuit breaker rated to handle the power requirements noted on the nameplate of the pump.

#### **CAUTION**

**To reduce the risk of hazards that can cause injury or property damage, observe the following precautions:**

- **DO NOT** use the power cord or strain relief to carry the pumps. Use the handle.
- **DO NOT** pull on the cord to disconnect the system or the pump. Pull the plug.
- **DO NOT** expose the control units to rain or snow.
- **DO NOT** operate the pumps or control units if they have been damaged in any way.
- **DO NOT** use pumps in pits handling raw sewage, salt water, or hazardous liquids.
- **DO NOT** disassemble the pumps or control units. When service is required, contact Glentronics' technical support at 800-991-0466, option 3. Return the product to the manufacturer for any repairs at the following address:

Glentronics, Inc.

645 Heathrow Drive, Lincolnshire, IL 60069

### BATTERY PREPARATION

#### **⚠ WARNING / POISON**

**Sulfuric acid can cause blindness or severe burns. Avoid contact with skin, eyes or clothing. In the event of accident, flush**

**with water and call a physician immediately. KEEP OUT OF REACH OF CHILDREN.**

**To help reduce these risks, observe the following precautions:**

- Someone should be within range of your voice or close enough to come to your aid when you work near a lead-acid battery.
- Have plenty of fresh water and soap nearby in case battery acid contacts skin, clothing or eyes.
- Wear eye and clothing protection and avoid touching your eyes while working with battery acid or working near the battery.
- If battery acid contacts skin or clothing, wash immediately with soap and water. If acid enters eye, immediately flood eye with running cold water for at least 15 minutes and get medical attention.
- Battery posts and terminals contain lead and lead compounds, chemicals known to the State of California to cause cancer and reproductive harm. Wash hands after handling.

### BATTERY PRECAUTIONS

#### **⚠ DANGER**

**Explosive gases could cause serious injury or death. Cigarettes, flames or sparks could cause battery to explode in enclosed spaces. Charge in well-ventilated area. Always shield eyes and face from battery. Keep vent caps tight and level.**

**To help reduce these risks, observe the following precautions:**

- **NEVER** smoke or allow a spark or flame in the vicinity of the battery.
- Use the Basement Watchdog control unit for charging a LEAD-ACID battery only. **DO NOT** use the control unit for charging dry-cell batteries that are most commonly used with home appliances.
- Be sure the area around the battery is well-ventilated.
- When cleaning or adding water to the battery, first fan the top of the battery with a piece of cardboard or another non-metallic material to blow away any hydrogen or oxygen gas that may have been emitted from the battery.

- **DO NOT** drop a metal tool onto the battery. It might spark or short-circuit the battery and cause an explosion.
- Remove personal metal items such as rings, bracelets, watches, etc. when working with a lead-acid battery. A short circuit through one of these items can melt it causing a severe burn.
- **ALWAYS** remove the charger from the electrical outlet before connecting or disconnecting the battery cables. *Never allow the rings to touch each other.*
- Check the polarity of the battery posts. The POSITIVE (+) battery post usually has a larger diameter than the NEGATIVE (-) post.

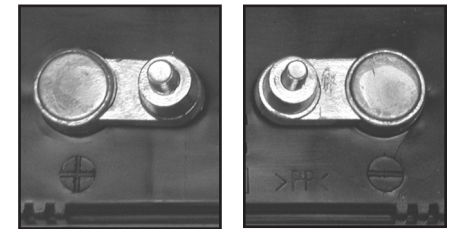

POSITIVE POST HAS LARGER DIAMETER

NEGATIVE POST HAS SMALLER DIAMETER

- When connecting the battery cables, first connect the small ring on the end of the WHITE wire to the NEGATIVE (-) post of the battery, and then connect the large ring on end of the BLACK wire to the POSITIVE (+) post of the battery.

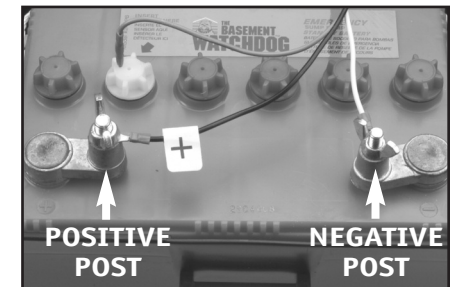

#### **⚠ DANGER**

**Do not use system to pump flammable or explosive fluids such as gasoline, fuel oil, kerosene, etc.**



## Introduction

The Basement Watchdog combination sump pump system is designed to provide both primary and backup pumping capabilities. The primary pump will operate as long as it is receiving AC power. If the power is interrupted, or more water is coming into the sump than the AC pump can handle, the backup sump pump will begin pumping automatically. The backup system has unique monitoring features that diagnose a problem and sound an alarm. A light on the display panel of the control unit will indicate the cause of the alarm and the corrective action. The two systems have been preassembled for easy installation.

### The Basement Watchdog Sump Pump System includes:

- A 1/3 HP primary pump with a caged dual float switch, and a blue piggyback controller that plugs into the wall outlet
- A yellow backup pump supported by a bracket
- A yellow control unit for the backup pump with a battery fluid sensor, a dual float switch, and battery cables
- A cable tie to attach the yellow control unit to the discharge pipe
- Two cable ties to secure the other wires to the discharge pipe
- A battery cap with a hole to accommodate the fluid sensor
- A battery charger
- A rubber union

### You will also need to supply:

- A Basement Watchdog Emergency Standby Battery or a Basement Watchdog 7.5 Hour Battery\*
- Six quarts of 1.265 specific gravity battery acid
- A battery box (optional)
- A surge protector (optional)

\*The internal construction of some wet cell batteries may not be compatible with this system. Glectronics can not guarantee the compatibility of other brands of batteries. The use of a Basement Watchdog battery is **HIGHLY** recommended.



### For some installations you may also need additional items:

- 1-1/2" rigid PVC pipe
- A 1-1/2" PVC pipe connector or a 1-1/2" rubber union
- PVC pipe cleaner and cement



## System Specifications

Power supply requirements . . . 115 volts, 60 Hz  
 AC pump pumping capacity. . . 2200 GPH @ 10'  
 DC pump pumping capacity. . . 1000 GPH @ 10'  
 Overall dimensions . . . . . 10"W x 17-3/4" H  
 Pump housings & strainers . . . . .Non-corrosive

## Installing the Pipe and Pump

The Basement Watchdog combination system is compact and will fit in a sump pit as small as 10" wide and 14" high (the size of a 5 gallon bucket). It measures 17<sup>3</sup>/<sub>4</sub>" inches from the bottom of the pump to the top of the Y-connector where it will be attached to the discharge pipe.

Use a pit that conforms to all local codes, and check the code to see if a gate valve or ball valve is required.

The discharge pipe must be positioned in a downward slope so any remaining water will drain away. Failure to do this will prevent water from exiting the pit and damage the pump if the line freezes.

The system should be placed on a flat surface free from dirt and debris. If the bottom of the sump pit is not clean, remove as much of the debris as possible. You may place a pump stand or bricks on the floor of the sump pit to raise the pump above the debris.

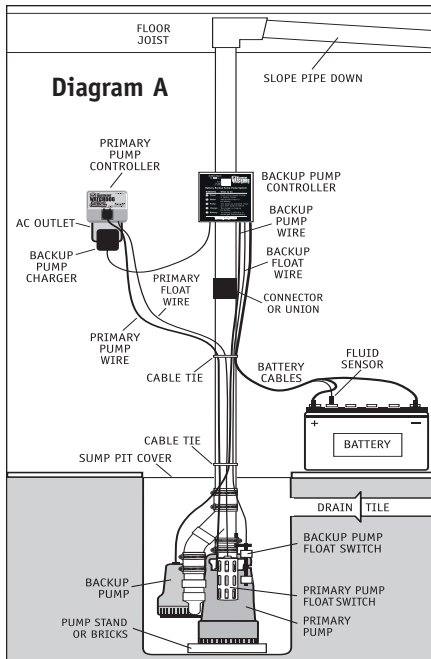
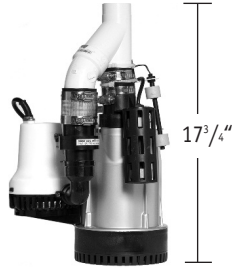

If you are replacing an old sump pump, **unplug the pump from the outlet.**

1. Remove the check valve or rubber union. If the existing system is installed without a check valve or rubber union, saw the pipe apart above the sump pit per #3 below. Discard the check valve. The Basement Watchdog system contains built-in check valves, so the old check valve will not be needed.

2. Remove the old pump from the pit, and unscrew the pipe and pipe adapter from the pump.

3. Measure the distance from the bottom of the sump pit (or from the top of the bricks in the sump pit) to the end of the discharge pipe. Subtract 18-3/4 inches (the height of the pump system + 1 inch). Cut a piece of 1-1/2" rigid PVC pipe to that length.

4. (a) Connect this piece to the discharge pipe by cementing the two pieces together with a 1-1/2" PVC pipe connector. (Follow the instructions on the PVC pipe cleaner and cement.) **or**, (b) connect the two pieces of pipe together with a rubber union.

5. Remove the assembled pump system from the shipping carton by lifting the strap at the bottom of the unit and supporting the top of the unit with your hand. Stand the unit on the ground near the sump pit. Visually inspect your pump. Products may be damaged during shipping. If the product has been damaged, contact your place of purchase or Glentronics before installation.

6. Slip the lifting strap off of the pump.

7. Remove the attached cords and controllers from the carton and place them next to the pump system. **BE SURE THE CORDS AND CONTROLLERS DO NOT FALL INTO THE SUMP PIT DURING THE INSTALLATION.**

8. Loosen the hose clamps on the enclosed rubber union, and slide the union up on the discharge pipe until it is even with the bottom of the pipe.

9. Lift the combination system by the handle on the primary pump and lower it into the sump pit. Make sure it is level.

10. Inspect the two float switches. They should both be vertical and positioned so that they move smoothly without hitting the pump or the wall of the sump pit.

11. Position the top of the pump system pipe so it is directly below the discharge pipe. Slide the rubber union down until half of the rubber union is covering the pump pipe, and the other half is covering the bottom of the discharge pipe. Tighten the hose clamp screws securely.

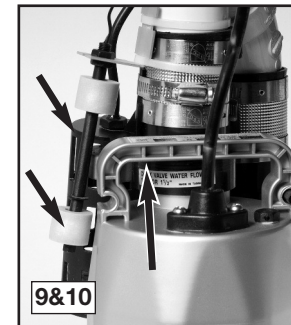
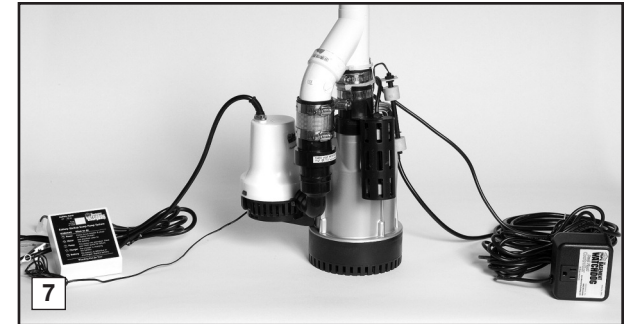
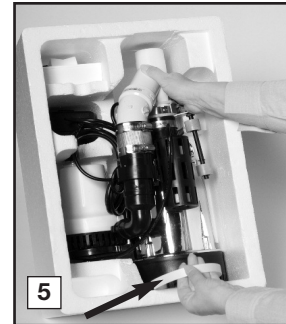
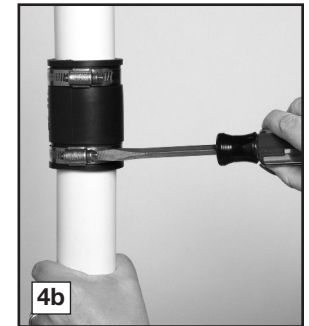
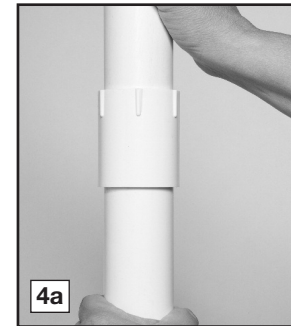
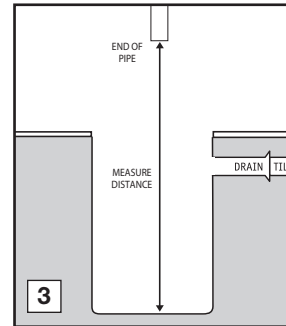
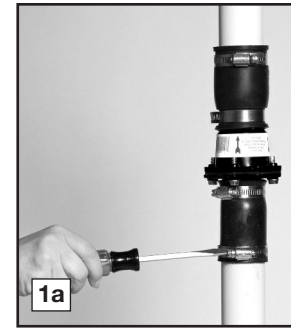



## Preparing the Battery

The Basement Watchdog Emergency Standby Battery has been designed to run the backup pump for a minimum of 6 hours continuously. However, most of the time the pump will turn on and off, and the battery will run the pump intermittently for days. In addition to the unique materials in the battery enable it to last for 5-7 years in standby service.

To extend the run time of the pump, use the Basement Watchdog 7.5 Hour battery. It will run this pump continuously for 12 hours. Why will it run longer than 7.5 hours? Because the 7.5 hour battery is rated for other Basement Watchdog pumps that draw more power (amps). The emergency pump puts less drain on the battery, so the battery lasts longer.

*NOTE: The battery will not run the primary pump.*

### CAUTION

- The use of automotive batteries is NOT recommended. Automotive batteries are not designed for this application. They will only run the pump for a short time and will have a shorter life than a standby battery.
- The battery fluid sensor and cap are designed to fit the Basement Watchdog batteries. Measuring the battery fluid is one of the most important features of the system; since about 80% of backup sump pump failures are the result of a battery that has dried out.
- The internal construction of some wet cell batteries may not be compatible with this system. Glentronics can not guarantee the compatibility of other brands of batteries. The use of a Basement Watchdog battery is **HIGHLY** recommended.

### DANGER

**DO NOT** use the enclosed battery cap on any battery except a Basement Watchdog battery. **DO NOT** drill a hole in the cap or the top of another brand of battery to accommodate the fluid sensor. Batteries emit explosive gases, which can cause serious injury or death.

### PREPARING THE BASEMENT WATCHDOG STANDBY BATTERY

The Basement Watchdog batteries are shipped dry (without acid) so they never lose power

before you take them home. A battery is activated when the acid is added, and then it slowly begins to deteriorate as it ages. By adding the acid just before use, the battery will always be fresh. Use 1.265 specific gravity battery acid to fill the battery. It is available where you purchased the battery.

*NOTE: Basement Watchdog batteries now come in two configurations. The tops of the batteries look different, and the directions for filling the batteries and connecting the fluid sensor will vary slightly. Instructions for both batteries follow. If the top of your battery looks like photo A, follow the instructions on this page. If the top of your battery looks like photo B on page 5, follow the instructions on page 5.*

### DANGER/POISON

**Contains sulfuric acid. Wear eye and clothing protection. If battery acid contacts skin or clothing, wash immediately with soap and water. If acid enters eyes, flush with water for 10 minutes and get medical attention. Review the safety instructions on page 1.**

1. If you have not purchased a battery box, place a plastic garbage bag on the floor with some paper towels or newspaper on top of it while you are filling the battery. Place the dry (unfilled) battery on top of the paper. If you have purchased a battery box, place it directly on the floor and place the battery in it.
2. Remove the foil seal on the top of the battery.
3. (a) Carefully push in the perforated tab at the top of the acid pack. Lift up the large tab and pull out the dispensing hose. Hold the hose upright above the pack and squeeze the hose forcing all the acid back into the pack. (b) Position the acid pack and battery as shown at the right. Pinch the end of the hose together and cut off the tip. Insert the end of the hose into each cell. Control the flow by pinching the hose with thumb and forefinger. **Fill each cell of the battery to a level just covering the battery plates, and then go back and top off each cell equally. It is important to have the cells filled equally or the battery will not operate properly.** The acid should reach a level about 3/16" below the cap rings. (Diagram B)

A newly filled battery will sometimes require additional acid after about ten minutes. Re-examine the fill level and add additional acid, if

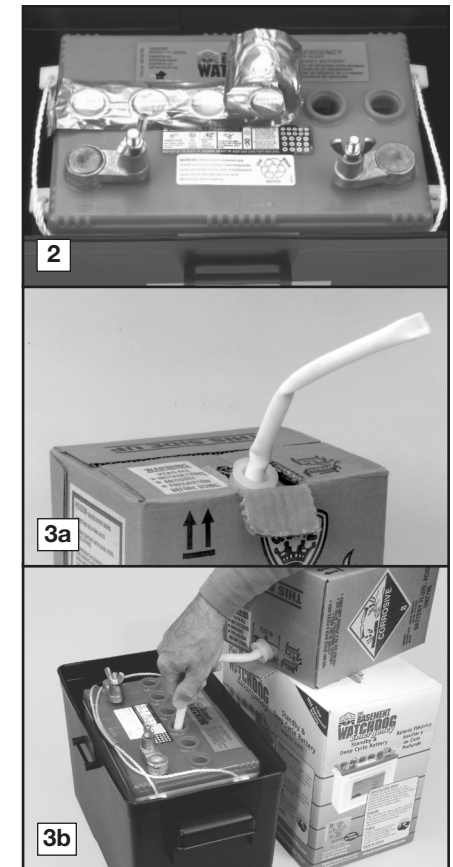
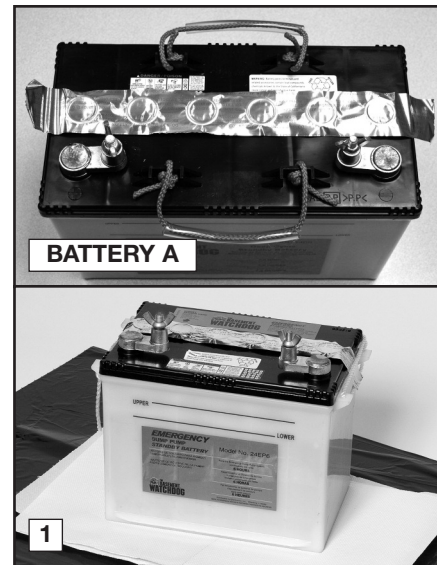

necessary. The battery acid may bubble at this time and give off a sulfur-like smell, but this is normal. After the battery has been filled, screw the caps on the top of the battery.

Within 15-30 minutes of adding acid, the battery will be 70-80% charged. The system will then finish charging the battery. During this time, the alarm may sound. This is normal.

Remove the paper and plastic bag from beneath the battery. Roll it up with the plastic on the outside and place it in the trash.

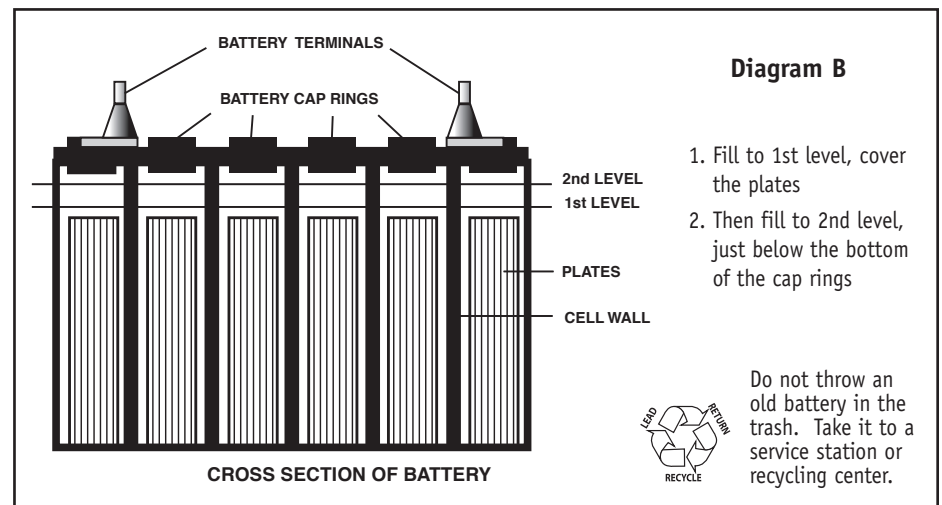



If your battery looks like the battery above, follow these directions.

1. If you have not purchased a battery box, place a plastic garbage bag on the floor with some paper towels or newspaper on top of it while you are filling the battery. Place the dry (unfilled) battery on top of the paper. If you have purchased a battery box, place it directly on the floor and place the battery in it.
2. Remove the two battery caps by carefully prying them up with a screwdriver. Place the screwdriver in the groove in the middle of the cap on the top of the battery. DO NOT lift the cap by prying up it from the groove on the side of the battery. It may damage the vent.
3. (a) Carefully push in the perforated tab at the top of the acid pack. Lift up the large tab and pull out the dispensing hose. Hold the hose upright above the pack and squeeze the hose forcing all the acid back into the pack. (b) Position the acid pack and battery as

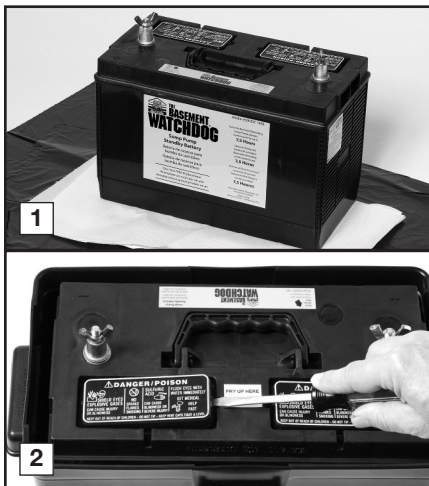

shown below. Pinch the end of the hose together and cut off the tip. Insert the end of the hose into each cell. Control the flow by pinching the hose with thumb and forefinger. **Fill each cell of the battery to a level just covering the battery plates, and then go back and top off each cell equally. It is important to have the cells filled equally or the battery will not operate properly.** The acid should reach a level about 3/16" below the cap rings. (Diagram B)

A newly filled battery will sometimes require additional acid after about ten minutes. Reexamine the fill level and add additional acid, if necessary. The battery acid may bubble at this time and give off a sulfur-like smell, but this is normal. After the battery has been filled, press the two caps on the top of the battery.

Within 15-30 minutes of adding acid, the battery will be 70-80% charged. The system will then finish charging the battery. During this time, the alarm may sound. This is normal.

Remove the paper and plastic bag from beneath the battery. Roll it up with the plastic on the outside and place it in the trash.

### CAUTION

**When you fill the battery for the FIRST time, it will be the ONLY time you add acid to the battery. In the future, when the fluid level is low, add distilled water to the cells. Never add more acid.**

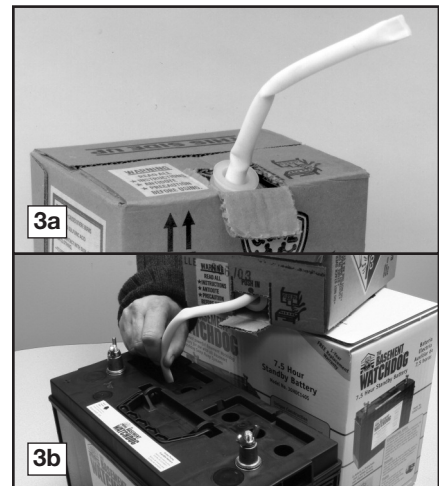

## System Connections

### ⚠ DANGER

**Risk of electrical shock or battery explosion, which can cause serious injury or death. Unplug the main AC pump to avoid electrical shock. Wear eye protection. Work in a well-ventilated area. Do not smoke or allow a spark or flame in the vicinity of the battery. Avoid dropping metal tools on the battery. If battery acid contacts eyes, flush with water for 15 minutes and get prompt medical attention. Review the safety instructions on page 1.**

### MOUNTING THE CONTROLLER

When you position the backup system control unit on the discharge pipe, be sure the charger cord will reach the AC power outlet and the pump cable and the float switch will reach the bottom of the sump. Position the unit in a well-ventilated area. Do not place anything on top of the battery. (Diagram C)

1. **Mounting the backup control unit:** (a) Thread one plastic cable tie through the two mounting brackets on the back of the control unit. (b) Secure the controller to the discharge pipe by wrapping the tie around the pipe and pulling it tight.
2. **Connecting the backup pump:** Remove the security tag from the pump and plug the pump wires into the pump connector on the back of the control unit.
3. **Installing the battery fluid sensor:** If you are using a battery box, remove the cover and fan the area around the top of the battery with a piece of cardboard (or another non-metallic material) to remove any hydrogen or

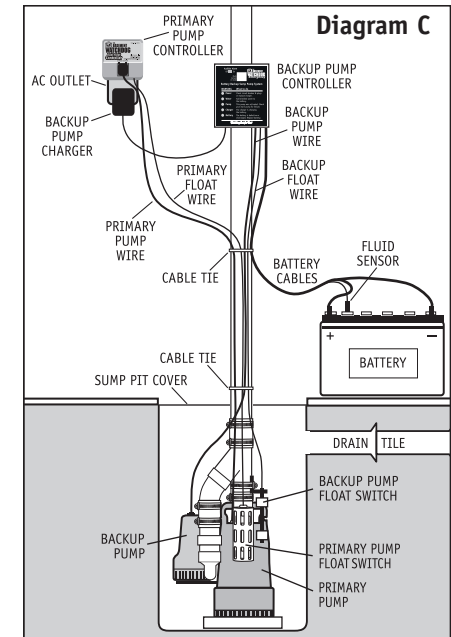

oxygen gas that may have been emitted from the battery. (a) If you have battery A, replace the battery cap that is 2nd from the POSITIVE (+) post of the battery with the battery cap that is provided in the Basement Watchdog package. An arrow on the top of the battery marks this position. There are two holes in the battery cap. Insert the fluid sensor in the hole that is off-center on the top of the cap. **Do not glue the sensor into the cap.** (b) If you have battery B, a hole has been molded into the top of the battery to accept the fluid sensor rod. The sensor hole is marked by the label on top of the battery. Hold the sensor straight and press it firmly into the hole all the way up to the connector. Do not bend the sensor rod.

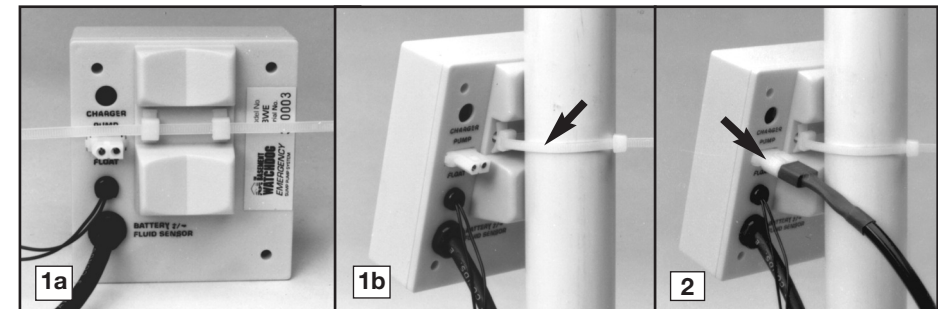



If you are not using the Basement Watchdog battery, you cannot use the battery fluid sensor. However, you must attach the sensor to the POSITIVE (+) post of the battery or the alarm will sound continuously. The Basement Watchdog sump pump system will not warn you if the fluid level is low in this configuration. You will need to check your battery every couple of months to see if it needs water. If the battery dries out, the system will not work.

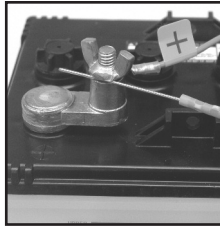

4. **Connecting the battery:** Remove the wing nuts from the battery terminals. Remove the security tag from the battery cables. Attach the battery cables to the battery...the WHITE wire to the

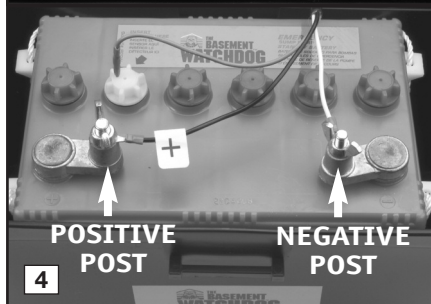
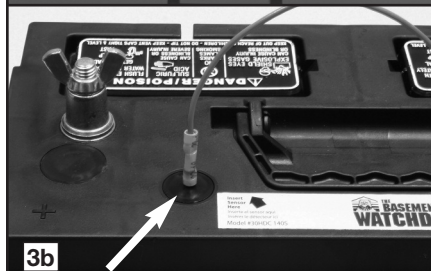
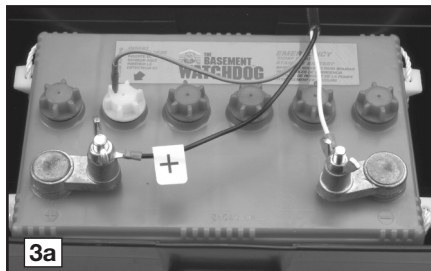

NEGATIVE (-) post, and then the BLACK wire to the POSITIVE (+) post. Replace the wing nuts and tighten. *Note: Connecting the cables to the wrong posts will damage the controller.*

5. **Connecting the charger:** Immediately plug the charger into the charger jack on the back of the control unit, then into an AC outlet on the wall. (You can provide additional protection for the control unit by using a surge protector.)
6. If the pump alarm is sounding, press the WHITE button to silence the alarm.
7. If you are using a battery box, place the cover on the box.
8. **Connecting the primary pump:** Plug the piggyback controller into a properly grounded 3-prong outlet (preferably with ground fault circuit interrupt). Then plug the primary pump into the receptacle on the controller.
9. For a neater installation, secure the cables from the controllers to the discharge pipe in a couple places with the additional cable ties. Make sure the wires are not touching each other or overlapping each other.
10. After the initial installation, be sure to check the pump operation by filling the sump with water and observing the pump through one full cycle. The primary pump should run for 10 seconds after the lower float drops.

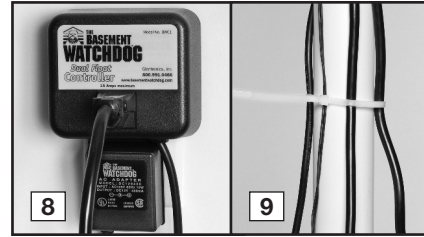
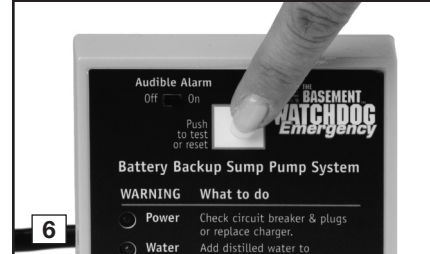
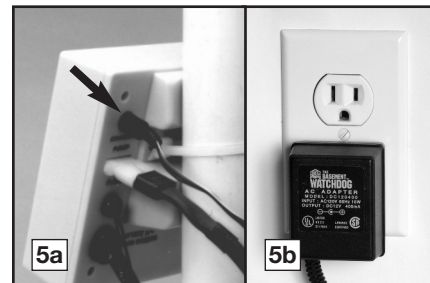

11. A pit cover is recommended for all installations as a safety measure, and to prevent debris from falling into the pit. Place the cover on top of the pit making sure not to pinch or crimp the pump wires with the cover. The pit cover usually has an existing hole that will allow the cords to be passed through it, or you can drill a hole in the cover.

## Product Operation

The dual float switch on the primary pump contains two large floating rings enclosed within a protective cage. Water will lift the bottom float by 1/4", which will activate the pump. If for any reason the lower float does not activate the pump, the water will rise to the second float, and it will activate the pump. As the pump evacuates the water from the pit, the floats will drop. The pump will run for an additional 10 seconds to extend the cycle after the lower float drops. The blue controller for the primary pump powers this switch.

During a power outage, or if more water is entering the sump than the primary pump can handle, the backup pump will automatically begin pumping. It also has a dual float switch, so if one float fails to activate the pump, the second float will activate the pump as soon as the water reaches that level. As the water recedes below the float switch, a timer in the control unit will run the pump an additional 25 seconds to evacuate the pit.

While the pumps are active, water will come out of the 1/8" hole that is located on the top of the main pump, and out of the hole in the elbow of the backup pump. This is normal. The holes are needed to prevent an air lock within the system. **DO NOT** obstruct the holes or an air lock may prevent the system from activating.

Batteries and sump pumps need maintenance. The control unit on the backup system monitors the battery and power conditions, and sounds an

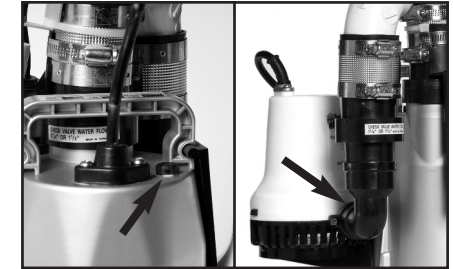

alarm when maintenance is required. Below is an explanation of the warnings and alarms.

## Understanding the Warnings & Alarms

The Basement Watchdog backup control unit features a series of warning lights that pinpoint potential problems. In addition, an alarm sounds to alert you to the problem. In some cases the lights and alarm will go off automatically when the problem has been solved. In others, the WHITE button must be pushed to silence the alarm. Refer to the table on page 7 for a quick review of the features and their corresponding alarm status.

Audible Alarm  
Off  On

Push to test or reset

**THE BASEMENT WATCHDOG Emergency**

**Battery Backup Sump Pump System**

	WARNING	What to do
①	Power	Check circuit breaker & plugs or replace charger.
②	Water	Add distilled water to the battery.
③	Pump	This pump was activated. Check your main pump for failure.
④	Charger	The charger is charging the battery.
⑤	Battery	The battery is defective or discharged. Replace battery.

**Watching Out for You!**

## SILENCING THE ALARM DURING AN EMERGENCY

The Basement Watchdog backup sump pump system is equipped with a switch that will silence the audible alarm during an extended emergency. The POWER and PUMP alarms can be

silenced during a power outage or during heavy rains when the pump is activated repeatedly.

To silence the POWER and PUMP alarms, slide the audible alarm switch to OFF.

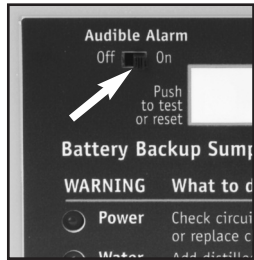

The POWER and/or the PUMP light will remain on, but the audible alarm will not sound.

**When the emergency has ended, slide the switch to the ON position to resume the full monitoring capability, or you will not be warned the next time an emergency occurs.**

The WATER and BATTERY alarms cannot be silenced. Both require immediate attention.

Warning	Alarm can be silenced before problem is corrected	Alarm shuts off automatically when the problem is corrected
POWER	Yes	Yes
WATER	No	Yes
PUMP	Yes	No, push white button
BATTERY	No	Yes

### ① Power

There are several causes for power failure. The most common is a power outage by your electric company. During this emergency, the Basement Watchdog system will automatically switch to battery power and protect your basement from flooding. You can silence the POWER alarm by sliding the audible alarm switch to OFF. The alarm will be silenced, but the light will stay on. The system will continue to operate while the power alarm is silenced. **Be sure to slide the switch to the ON position when power is restored to resume full monitoring capability.**

1. If the power is on in the rest of the house, check the outlet, the home circuit breaker or the fuse box for failure, and correct the problem.

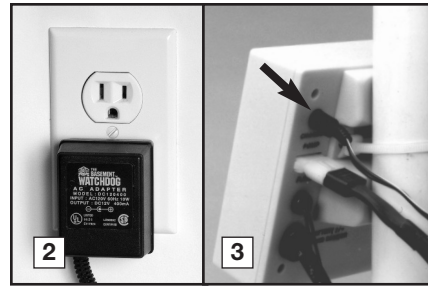

2. Check the charger. Make sure it is securely plugged into the wall outlet. Make sure the power outlet is working.
3. Check the charger plug that fits into the rear panel of the control unit. Make sure it is securely plugged into the control unit.

The control unit must receive 115 volts AC +/- 5% from the AC outlet. Any voltage lower than 110 volts will activate the POWER alarm. Lower voltages can be caused by utility brown outs or a heavy power draw from other appliances on the same circuit.

If all the connections are secure and the wall outlet is operating, but the POWER warning light is still on, replace the charger unit. Contact Glentronics, Inc. at 800-991-0466, option 3.

### ② Water

**⚠ DANGER**

**Risk of electrical shock or battery explosion, which can cause serious injury or death. Wear eye protection. Work in a well-ventilated area. Do not smoke or allow a spark or flame in the vicinity of the battery. Avoid dropping metal tools on the battery. If battery acid contacts eyes, flush with water for 15 minutes and get prompt medical attention. Review the safety instructions on page 1.**

If this warning light and alarm are on, you need to add distilled water to the battery. (This alarm cannot be silenced. When the battery is refilled and the sensor is replaced, the alarm will go off automatically.) To refill the battery:

1. Unplug the charger and the blue AC pump controller from the wall outlet.
2. If you are using a battery box, remove the cover and fan the area around the top of the

battery with a piece of cardboard (or another non-metallic material) to remove any hydrogen or oxygen gas that may have been emitted from the battery.

3. Then unscrew the wing nuts and remove the battery cables and the fluid sensor from the battery.
4. Remove the battery caps. Add distilled water to each cell. If distilled water is not available, tap water with a low mineral content may be used. Well water is not recommended. **NEVER ADD MORE ACID.** Fill the battery to level 2 as shown in Diagram B on page 4. (The Basement Watchdog battery filler will automatically fill the level to the correct height. See enclosed order form.)
5. Using a paper towel, clean the underneath portion of the battery cap that contains the fluid sensor. Replace the battery caps and the fluid sensor. Be sure the fluid sensor is positioned in the 2nd cell from the positive post. Depending on which battery you own, the sensor will fit in the top of the battery cap or in the molded hole on the top of the battery. The location is marked with an arrow on the top of the battery. The warning light and alarm will turn off automatically when the battery is refilled and the sensor is replaced.
6. Replace the battery cables, the WHITE to the NEGATIVE (-) post, and the BLACK to the POSITIVE (+) post. Replace the wing nuts and tighten.

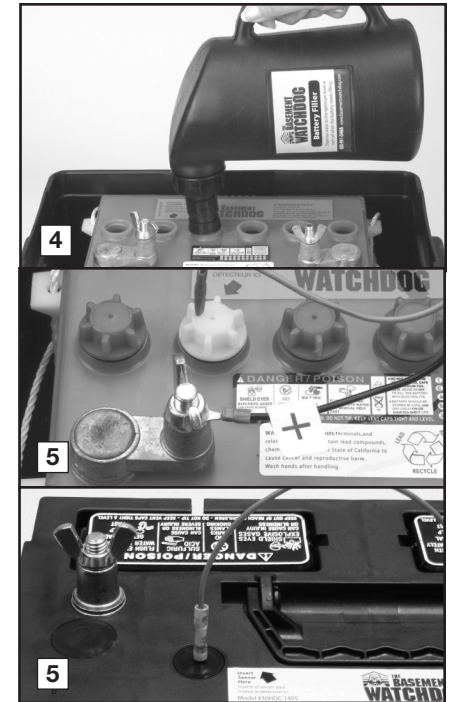
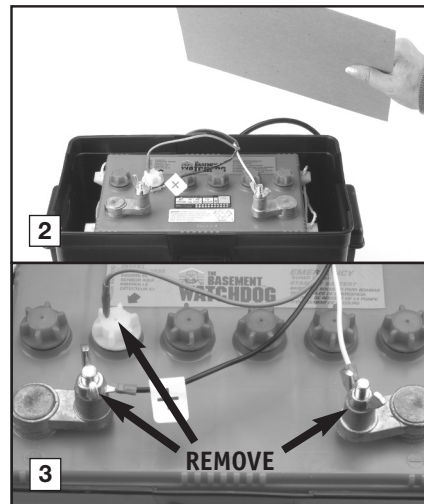

7. Replace the battery box cover.
8. Plug the charger and the blue AC controller back into the outlet. (You should provide additional protection for the control unit by using a surge protector.)

### ③ Pump

When the water rises in the sump pit and lifts the float switch, the pump will begin pumping, and the PUMP light and alarm will turn on. The pump warning stays on to alert you to the fact that the standby system was used to empty the water from the sump. Try to determine what caused the system to activate.

- Check the main pump for failure. It may not be working, the float switch may be stuck, or the pump may be too small to handle the inflow of water.
- Make sure the check valves are working and installed correctly. They may need to be replaced. (See page 12 for check valve locations).
- Make sure the discharge pipe is not clogged or frozen.



- If the power was out, and the backup pump was activated, you need to push the WHITE button to silence the alarm.

During a power outage or times when the pump is activated repeatedly, you can temporarily silence the alarm by sliding the Audible Alarm switch to OFF. **When the primary pump has resumed normal operation and the backup pump is no longer activating repeatedly, slide the switch to the ON position to resume the full monitoring capability.** The alarm and pump light will still be on. Push the WHITE button to silence the alarm.

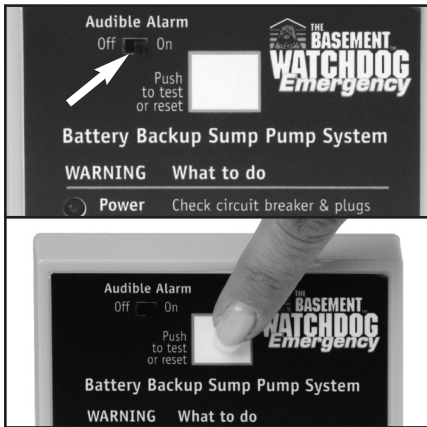

## REPLACING THE BACKUP PUMP

Before you begin this process you will need a new backup pump. You may also want to change the check valves at this time. The backup pump uses a 1-1/4" check valve, the primary pump uses a 1-1/2" check valve. (See parts list on page 12.)



### **⚠ DANGER**

**Risk of electrical shock or battery explosion, which can cause serious injury or death. Wear eye protection. Work in a well-ventilated area. Do not smoke or allow a spark or flame in the vicinity of the battery. Avoid dropping metal tools on the battery. Review the safety instructions on page 1.**

**YOU WILL BE DISCONNECTING ALL THE WIRES. BE SURE THEY DO NOT FALL INTO THE SUMP PIT. SEE DIAGRAM ON PAGE 12 FOR PARTS DESCRIPTION.**

1. Unplug the primary pump from the blue controller.
2. Remove the charger plug from the back of the yellow controller.
3. Unplug the backup pump from the back of the yellow controller.
4. Remove the sensor from the battery.
5. Remove the battery wires from the battery terminals. **Be sure they do not touch each other while one is connected to the battery.**
6. Slowly loosen the rubber union on the top of the combination pump assembly to separate the pipes. The water trapped in the pipe will pour out into the sump as the rubber union is loosened.
7. Separate the pump assembly from the rubber union and lift it out of the sump by the handle on the primary pump.
8. Turn the assembly up side down over the sump pit to allow the remaining water in the system to drain.
9. Loosen the screws on the no-hub connector on the elbow of the backup pump.
10. Unscrew the screw on the bottom of the pump bracket with a Phillips head screwdriver, and lift the pump off of the bracket. Then pull the pump down out of the no-hub connector.
11. Unscrew the check valve on the elbow of the backup pump. Now reverse the process.
12. Screw the check valve on to the new pump. (You can use the existing check valve, or preferably replace it with a new one.)
13. You must drill a 1/8" hole in the elbow of the new pump to prevent an air lock in the system. An air lock will prevent the pump from operating. Drill the hole on a downward slope below the check valve on the elbow.
14. Push the pump and check valve back up into the no-hub connector, and place the pump on the pump bracket.
15. Screw the pump onto the bracket.
16. Tighten the hose clamp on the no-hub connector.
17. Lower the pump system back into the sump pit.

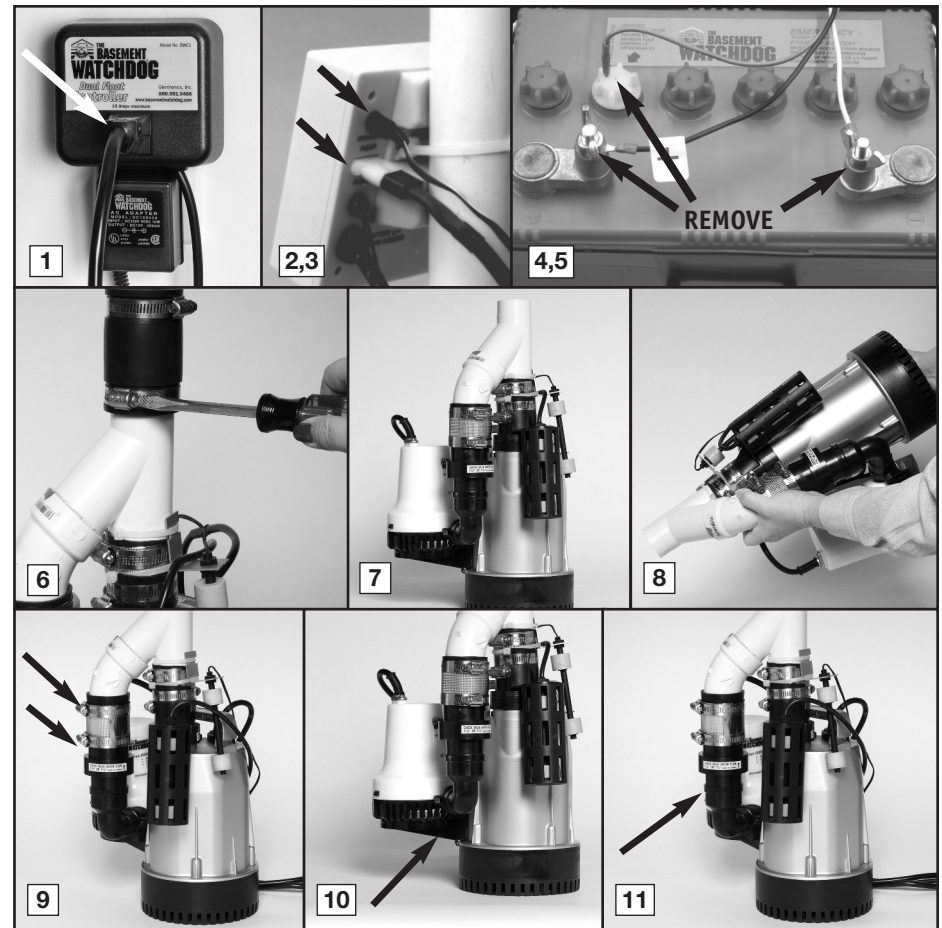

18. Connect the top of the system to the rubber union and tighten the hose clamp.
19. Connect the battery cables to the battery terminals, WHITE to the NEGATIVE (-) post, and BLACK to the POSITIVE (+) post.
20. Insert the fluid sensor into the top of the battery.
21. Plug the backup pump into the back of the yellow controller.
22. Plug the charger into the back of the yellow controller.
23. Plug the primary pump into the blue controller.

## REPLACING THE PRIMARY PUMP

Before you begin this process you will need a new AC pump. You may also want to change the

check valves at this time. The backup pump uses a 1-1/4" check valve, the primary pump uses a 1-1/2" check valve. (See parts list on page 12.)



### **⚠ DANGER**

**Risk of electrical shock or battery explosion, which can cause serious injury or death. Wear eye protection. Work in a well-ventilated area. Do not smoke or allow a spark or flame in the vicinity of the battery. Avoid dropping metal tools on the battery. Review the safety instructions on page 1. REFER TO THE PHOTOS ON PAGE 9**

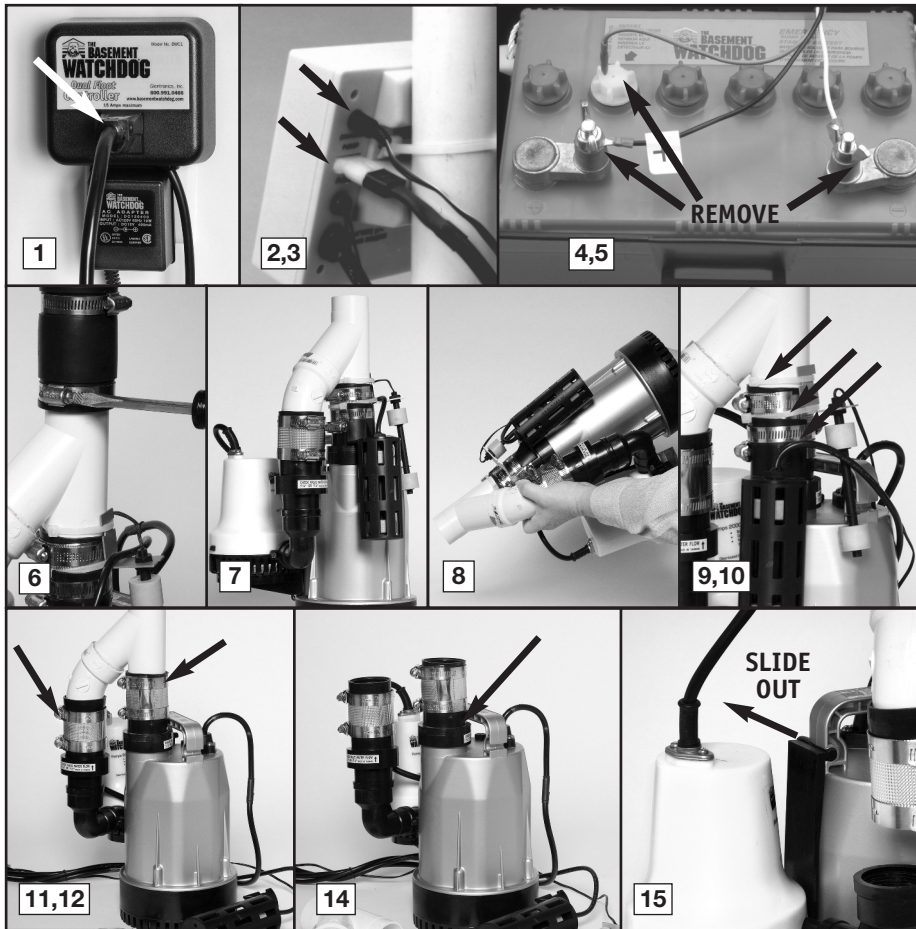

**YOU WILL BE DISCONNECTING ALL THE WIRES. BE SURE THEY DO NOT FALL INTO THE SUMP PIT. SEE DIAGRAM ON PAGE 12 FOR PARTS DESCRIPTION.**

1. Unplug the primary pump from the blue controller.
2. Remove the charger plug from the back of the yellow controller.
3. Unplug the backup pump from the back of the yellow controller.
4. Remove the sensor from the battery.
5. Remove the battery wires from the battery terminals. **Be sure they do not touch each other while one is connected to the battery.**
6. Slowly loosen the rubber union on the top of the combination pump assembly to separate

the pipes. The water trapped in the pipe will pour out into the sump as the rubber union is loosened.

7. Separate the pump assembly from the rubber union and lift it out of the sump by the handle on the primary pump.
8. Turn the assembly up side down over the sump pit to allow the remaining water in the system to drain.
9. Loosen the hose clamp on the caged float switch and remove the float switch.
10. Cut the cable ties on the backup float switch and remove it.
11. Loosen the hose clamp on the top of the no-hub connector on the primary pump.

12. Loosen the hose clamp on the top of the no-hub connector on the backup pump.
13. Remove the Y-connector.
14. Unscrew the primary pump check valve.
15. Carefully slide the backup pump and bracket out of the handle of the primary pump. Now reverse the process.
16. Carefully slide the backup pump and bracket into the handle of the new primary pump.
17. Screw in the check valve on the top of the primary pump. (You can use the existing check valve, or preferably replace it with a new one.)
18. Connect the Y-connector to the top of the check valve with the no-hub connector and tighten the hose clamp.
19. Connect the backup pump to the other side of the Y-connector with the other no-hub connector.
20. Replace the caged float switch by tightening it with its hose clamp.
21. Replace the backup pump float switch using 2 new cable ties. Make sure the float moves easily, and will not get hung up on the pump.
22. Lower the pump back into the pit by the handle of the primary pump.
23. Connect the top of the system to the rubber union and tighten the hose clamp.
24. Connect the battery cables to the battery terminals, WHITE to the NEGATIVE (-) post, and BLACK to the POSITIVE (+) post.
25. Insert the fluid sensor into the top of the battery.
26. Plug the backup pump into the back of the yellow controller.
27. Plug the charger into the back of the yellow controller.
28. Plug the primary pump into the blue controller.

#### ④ Charger

This green light should always be flashing. It indicates that the system is operating, and the battery is connected. If this light is off:

- Check the charger. Make sure it is securely plugged into the wall outlet.
- Check the charger plug that fits into the rear panel of the control unit. Make sure it is securely plugged into the control unit.
- If all connections are secure and the wall outlet is operating, but the POWER warning light is flashing, replace the charger. Call Glentronics parts department at 800-991-0466, option 3.

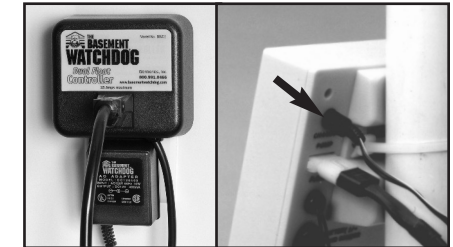

#### ⑤ Battery

This light and alarm will go on when the control unit senses that the battery has approximately 1/2 hour of continuous pumping energy left. This alarm cannot be silenced. It indicates that your battery is discharged or defective and immediate action needs to be taken to replace the battery or clean the terminals. This alarm will sound when:

- Corrosion on battery terminals and/or cable rings is preventing the battery from charging properly
- The battery is getting old and should be replaced
- The pump has been running for many hours and the battery is discharged

Check the battery cables and the battery terminals for corrosion. Clean and tighten them as needed. The procedure is described on the following page.

If the battery alarm goes on while the pump is running and the power is out, you will have a minimum of 1/2 hour of pumping time to replace the battery. (In most cases, the pump does not run continuously, and therefore, you actually have a longer time to replace it.) You will not be able to silence the alarm. Left unattended, the basement will flood. In a severe emergency,

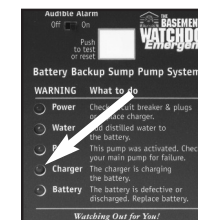



if a replacement battery is not available, you could temporarily use your car battery.

Once the AC power is restored, the battery will recharge automatically, unless it is old or damaged. The alarm will go off when the AC power is restored and the pumping energy reaches 1/2 hour or more.

In the event that your Basement Watchdog backup sump pump has pumped for an extended period of time, the battery may be very depleted. In this condition, when the AC power is returned to the unit, a battery alarm will continue to sound. The battery may need a longer period to recharge.

For a faster recharge, an automotive or marine battery charger can be used to recharge the battery. Follow the manufacturer's instruction and safety information included with the charger.

If the battery is relatively new and the battery alarm is activated, before you replace the battery, call the Glentronics service department. The phone number is 800-991-0466, option 3.

## TO CLEAN THE BATTERY TERMINALS AND CABLES

### **⚠ DANGER**

**Risk of electrical shock or battery explosion, which can cause serious injury or death. Wear eye protection. Work in a well-ventilated area. Do not smoke or allow a spark or flame in the vicinity of the battery. Avoid dropping metal tools on the battery. If battery acid contacts eyes, flush with water for 15 minutes and get prompt medical attention. Review the safety instructions on page 1.**

1. Unplug the charger and blue AC controller from the wall outlet.
2. Remove the cover of the battery box by pushing in the tabs on the front and back, then lifting up.

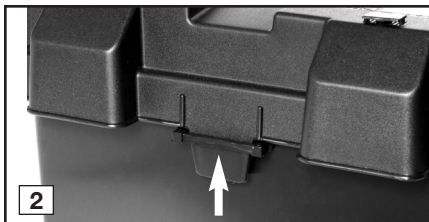

3. Fan the area around the top of the battery with a piece of cardboard (or another non-metallic material) to remove any hydrogen or oxygen gas that may have been emitted from the battery.
4. Remove the fluid sensor from the battery. Unscrew the wing nuts. Remove the battery cables.
5. Clean the battery posts with a battery terminal cleaner or a wire brush.
6. Clean any corrosion off of the ring connectors on the ends of the battery wires. Use a stiff brush or sandpaper. **DO NOT** apply corrosion resisting sprays or pads to the terminal rings or posts after you have cleaned them, since this could prevent the system from charging properly.

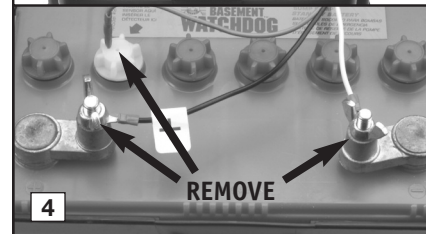
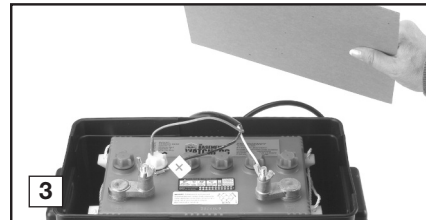

7. Replace the fluid sensor in the top of the battery. Then replace the battery cables, WHITE to the NEGATIVE (-) post and BLACK to the POSITIVE (+) post. Tighten the wing nuts.
8. Plug the charger and the blue AC pump controller back into the wall outlet. (You should provide additional protection for the control unit by using a surge protector.)
9. You may have to press the WHITE button to silence the PUMP alarm.

## REPLACING THE BATTERY

### **⚠ DANGER**

**Risk of electric shock or battery explosion, which can cause serious injury or death. Wear eye protection. Work in a well-ventilated area. Do not smoke or allow a spark or flame in the vicinity of the battery. Avoid dropping metal tools on the battery. If battery acid contacts eyes, flush with water for 15 minutes and get prompt medical attention. Review the safety instructions on page 1.**

### REFER TO THE PHOTOS AT RIGHT AND ON PAGE 11

Basement Watchdog batteries come in two configurations. (A) One has six battery caps that screw into the top of the battery, and the fluid sensor fits in the cap with the two holes. (B) The other battery has two large caps that each snap over 3 holes. The sensor hole in this battery is molded in the top of the battery.

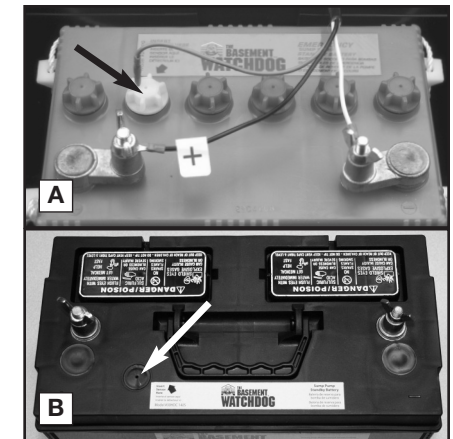

1. Unplug the charger and blue AC controller from the wall outlet.
2. If you are using a battery box, remove the cover and fan the area around the top of the battery with a piece of cardboard (or another non-metallic material) to remove any hydrogen or oxygen gas that may have been emitted from the battery.
3. Remove the fluid sensor from the top of the battery. If the sensor was in the cap of the battery, remove the battery cap and save it for use in a new battery.
4. Unscrew the wing nuts and remove the battery cables.

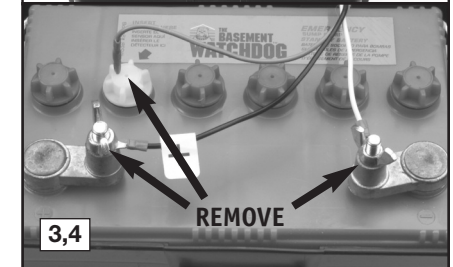
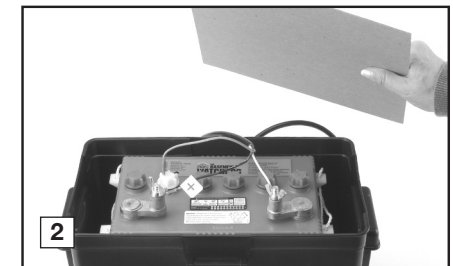

5. Remove the old battery. Fill the battery following the instructions on page 4.
6. Clean any corrosion off of the wire ring connectors on the end of the battery cables. Use a wire brush or sandpaper. **DO NOT** apply corrosion resisting sprays or pads to the terminal rings or posts after you have cleaned them, since this could prevent the battery from charging properly.
7. Replace the battery cables, WHITE to the NEGATIVE (-) post and BLACK to the POSITIVE (+) post.

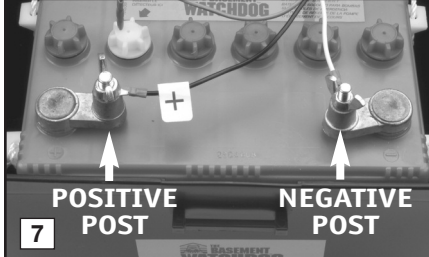

8. (a) If the new battery has six caps, rinse and dry the cap with the extra hole from the old battery to remove any residue. Replace the battery cap that is 2nd from the POSITIVE post with the cap from the old battery. Insert the fluid sensor in the cap and put the cap you removed from the new battery on the old battery. (b) If the new battery has the sensor hole molded in the top you will not need to save the cap from the old battery, press the sensor firmly into the hole. Do not bend the sensor rod.
9. Plug the charger and the blue AC controller into the wall outlet. (You should provide additional protection for the control unit by using a surge protector.
10. You may have to press the WHITE button to silence the PUMP alarm.

### TEST BUTTON

The TEST button may be used to check the backup pump and system. Push the TEST button. This will activate the pump for as long as you hold the button.

### TESTING THE BACKUP FLOAT SWITCH

*It is important to manually test the float switch periodically.*

Lift the float up and let go. This will activate the pump. The control unit will run the pump for approximately 25 seconds so it can empty all the water in the sump pit.

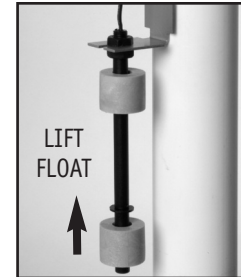

If there is no water in the pit, the pump can run dry for this amount of time. The alarm will sound and the PUMP light will go on. After the pump has stopped, push the WHITE button to silence the alarm. If the WHITE button is pressed before the pump has stopped, the alarm will go off temporarily. Wait for the pump to stop pumping, and then push the WHITE button to completely silence the alarm.

While the pumps are active, water will come out of the 1/8" holes located on the top of the main pump and in the elbow of the backup pump. This is normal. The holes are needed to prevent an air lock within the system. **DO NOT** obstruct the holes or an air lock may prevent the system from activating.



### TESTING THE PRIMARY PUMP FLOAT SWITCH

Lift the float within the cage with a pencil or other non-metallic item and let it drop. The pump will run for an additional 10 seconds after the float returns to the original position. This will not damage the pump to run it for this short time if the sump pit is dry. However, **DO NOT** hold the float up for an extended time without water in the sump.



### MAINTENANCE CHECK LIST

Maintenance should be performed 1-2 times per year.

1. Lift the float switches on both pumps as described above.
2. Remove all debris from the bottom of the pit.
3. Remove all debris floating in the water.
4. Remove all debris from the float switch cage.
5. Fill the pit with water. Make sure the pumps turn on at the intended levels.
6. While the pump is running, make sure the pump is evacuating water at a good pace.
7. Remove the fluid sensor and cap from the battery and rinse any black buildup from the cap. Replace the cap and fluid sensor.

### PARTS & SERVICE INFORMATION

You can receive technical support, parts or service information by calling Glentronics, Inc. at 800-991-0466, option 3, or by visiting the website at [www.basementwatchdog.com](http://www.basementwatchdog.com). Send your unit to the following address for repairs:

Glentronics, Inc.  
645 Heathrow Drive, Lincolnshire, IL 60069



# Replacement Parts List

## Description

Description	Part No.
1/3 HP AC sump pump	BW1033-GL
Caged dual float switch with piggyback controller	BWC2
Emergency backup pump	1011004
Emergency control unit	BWE-CONT
"Y" PVC pipe fitting	1120007
Support bracket for backup pump	1121003
Battery cap with hole for the fluid sensor	1125000
Charger for backup pump	1015003
Backup dual float switch	1020009
Backup pump locking screw (#12 x 1/2" pan head)*	1100018
1-1/4" check valve for backup pump*	1141000
1-1/2" check valve for primary pump*	1141001
No-hub stainless steel connectors*	1142000
1-1/2" rubber union*	1142001
2" hose clamp*	1122002
Cable tie*	1122000

\*Stock items available in plumbing department

Call 800-991-0466, option 3 to order parts.

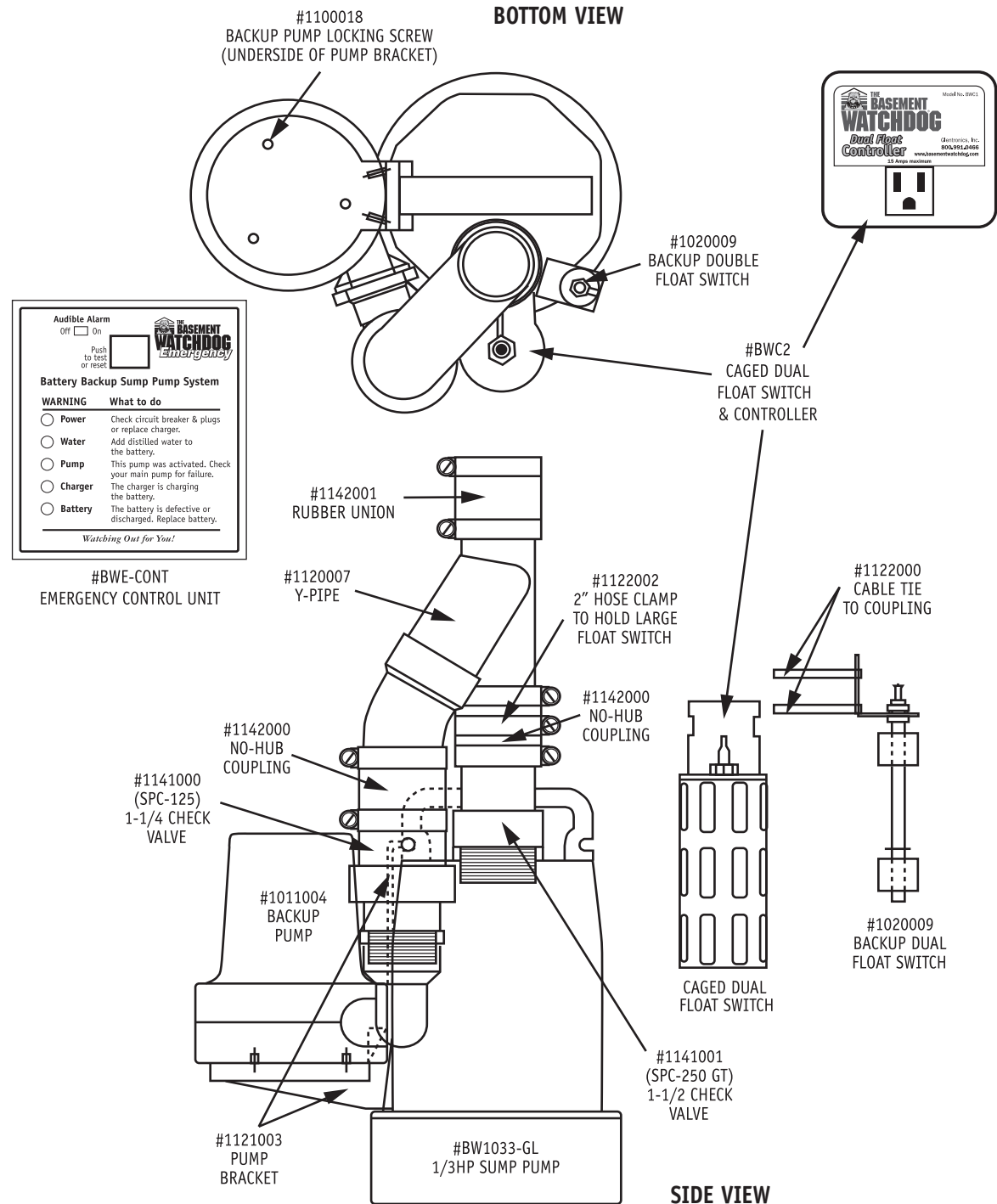

## Primary Pump Troubleshooting Guide

### **⚠ DANGER**

Read safety warnings & instructions before attempting any repairs or maintenance.

Potential Cause	THE PUMP WILL NOT START OR RUN	Solutions
Pump is not plugged in	Plug pump in properly (see instructions)	
No AC power	Check circuit breaker or fuse, and GFI reset button	
Poor power source	Check circuit line wires, cable and outlet	
Locked impeller	Remove strainer and clear obstruction	
Defective float switch	Replace float switch with new float switch	
Defective pump	Replace pump with new pump	
Potential Cause	THERMAL PROTECTOR TRIPPING OR NOT FUNCTIONING	Solutions
Locked impeller	Remove strainer and clear obstruction	
Incorrect power supply	Check power supply source and voltage	
Pump running continuously with no water present	Check float switch	
Potential Cause	PUMP STARTS AND STOPS TOO FREQUENTLY	Solutions
Float switches mounted too low	Raise both float switches	
Water back flowing from pipe	Install or replace check valve	
Malfunctioning float switch	Replace float switch with new float switch	
Potential Cause	PUMP WILL NOT SHUT OFF	Solutions
Clogged or frozen discharge	Clear blockage or thaw frozen line	
Blocked intake strainer	Clear debris from intake strainer	
One or both of the floats is obstructed and cannot drop down	Clear debris from inside the float cage (Loosen nut on top of float, then remove c-clip on bottom of float. Remove debris. Tighten nut on top of float, then replace c-clip on bottom of float.) When reassembling the float, the magnetic strip on the inside of the float should be facing down.	
Defective float switch	Replace float switch with new float switch	
Check valve is stuck	Replace check valve.	
Potential Cause	INSUFFICIENT OR NO WATER VOLUME	Solutions
Check valve on secondary pump will not close and water re-circulates within the system	Replace the check valve on the secondary pump	
Partially blocked impeller	Remove strainer and clear obstruction	
Clogged or frozen discharge pipe	Clear blockage or thaw frozen line	
Broken or leaking pipe	Repair pipe	
Low power voltage	Check power voltage, wires and cable condition	
Check valve is stuck	Replace check valve.	
Potential Cause	ABNORMAL SOUND OR VIBRATION	Solutions
Check valve is broken	Replace the check valve	
Blocked intake screen	Clear debris from intake screen	
Defective pump	Replace pump	

If the above solutions do not resolve the problem, follow the instructions within this manual to disconnect the system from the outlet and battery terminals, then reconnect the system and push the reset button. If the problem continues, contact customer service.

## Backup Pump Troubleshooting Guide

### **⚠ DANGER**

Read safety warnings & instructions before attempting any repairs or maintenance.

Potential Cause	BATTERY FLUID LOW	Solutions
The battery fluid is low	Add distilled water to each cell of the battery	
The fluid sensor is installed improperly	The fluid sensor should be inserted into the designated hole on the top of the battery and pushed down	
Not using a Basement Watchdog battery	This feature cannot be used. Attach the fluid sensor to the positive post of the battery	
Potential Cause	BATTERY PROBLEM	Solutions
Terminals are corroded	Clean terminals and cables	
Cables are loose	Tighten wing nuts	
Battery is discharged below 25%	Replace battery if power is out. There is only 1 hour of continuous pumping power left. Battery will recharge when power is restored	
Battery is old or damaged	Replace battery	
Potential Cause	POWER FAILURE	Solutions
Power outage	None. The backup pump will run off of the battery. Flip the alarm switch to the off position to silence the alarm. Be sure to flip it back to on when the power is restored.	
An outlet, fuse, or circuit breaker has failed	Try another outlet, replace the fuse, or reset the circuit breaker	
The charger is unplugged from the wall or the back of the controller	Make sure the power cord is plugged in securely	
The control unit is receiving less than 110 volts from the outlet	None, if the utility company has instigated brown outs. Otherwise, reduce the number of other appliances on the circuit	
Potential Cause	PUMP WILL NOT SHUT OFF	Solutions
Backup pump is unplugged	Make sure the pump is securely plugged into the back of the control unit	
Backup pump is clogged	Remove strainer from pump and clean out any debris	
Backup pump is broken	Replace the pump	
Potential Cause	INSUFFICIENT OR NO WATER VOLUME	Solutions
The main AC pump failed because of a power outage	None. The backup pump was activated when needed	
The water was coming into the sump faster than the main pump could evacuate it	None. The backup pump was activated when needed	
The float switch on the main AC pump is stuck or defective	Free the float switch on the main pump or replace it	
The main AC pump is broken	Replace the main AC pump	
The main AC pump could not keep up with the inflow of water	None. The backup pump was activated as needed. If this is a recurring problem, install a higher capacity main pump	
The check valve is stuck and the water cannot pass through it	Replace the check valve	
The discharge pipe is clogged or frozen and the water cannot pass through it	Thaw, cleanout the blockage, or replace the discharge pipe	
There is a slight chance of false activation if the float switch cord is wrapped around the AC power cord	Move the float switch cord away from the AC power cord	
Potential Cause	ABNORMAL SOUND OR VIBRATION	Solutions
Check valve is broken	Make sure check valve is functioning, or replace it	
Discharge pipe is clogged or frozen	Clear the discharge pipe	



## Limited Warranty

GLETRONICS, INC. warrants to the original retail purchaser that all of its pump, switch, sensor, battery box and control unit products are free from defective materials and workmanship for the period indicated below:

All parts and labor (excluding installation) for a period of  
two (2) years from the date of purchase

The defective product must be returned directly to the factory, postage prepaid with the original bill of sale or receipt to the address listed below. Glentronics, Inc., at its option, will either repair or replace the product and return it postage prepaid.

### CONDITIONS

The unit must be shipped freight prepaid, or delivered, to Glentronics, Inc. to provide the services described hereunder in either its original carton and inserts, or a similar package affording an equal degree of protection.

The unit must not have been previously altered, repaired or serviced by anyone other than Glentronics, Inc., or its agent; the serial number on the unit must not have been altered or removed; the unit must not have been subject to accident, misuse, abuse or operated contrary to the instructions contained in the accompanying manual.

The dealer's dated bill of sale, or retailer's receipt, must be retained as evidence of the date of purchase and to establish warranty eligibility.

This warranty does not cover product problems resulting from handling liquids hotter than 120 degrees Fahrenheit, handling inflammable liquids, solvents, strong chemicals or severe abrasive solutions; normal wear; user abuse; misuse, neglect, improper maintenance, commercial or industrial use; improper connections or installation; damages caused by lightning strikes, excessive surges in AC line voltage, water damage to the controller, other acts of nature, or failure to operate in accordance with the enclosed written instructions.

GLETRONICS, INC. WILL NOT BE LIABLE FOR ANY INCIDENTAL, SPECIAL OR CONSEQUENTIAL DAMAGES FOR BREACH OF ANY EXPRESS OR IMPLIED WARRANTIES ON THIS PRODUCT. SOME STATES DO NOT ALLOW THE EXCLUSION OR LIMITATION OF CONSEQUENTIAL OR INDIRECT DAMAGES, SO THE ABOVE LIMITATION MAY NOT APPLY TO YOU. THIS EXPRESS WARRANTY SHALL BE EXCLUSIVE AND IS IN LIEU OF ALL OTHER WARRANTIES, WRITTEN OR ORAL, EXPRESS OR IMPLIED, INCLUDING, BUT NOT LIMITED TO ANY WARRANTY OF MERCHANTABILITY OR FITNESS FOR A PARTICULAR PURPOSE. THE CUSTOMER'S EXCLUSIVE REMEDY FOR BREACH OF THIS WARRANTY, OR OF ANY IMPLIED WARRANTY NOT EXCLUDED HEREIN, SHALL BE LIMITED TO REPAIR OR REPLACEMENT OF THE PRODUCT.

For information or service contact:

**Glentronics, Inc.**  
**645 Heathrow Drive**  
**Lincolnshire, IL 60069**  
**800-991-0466**

Model # DFK961    Serial # \_\_\_\_\_    Purchase Date \_\_\_\_\_