



KALORIK
 **KALORIK**



**Steam Iron with
retractable cord**

www.KALORIK.com

**USK DA 31066
USK DA 31067
120V~ 60Hz 1200W**



EN OPERATING INSTRUCTIONS

IMPORTANT SAFEGUARDS

When using your appliance, basic safety precautions should always be followed, including the following:

READ ALL INSTRUCTIONS

WARNING: To reduce the risk of fire, electric shock or injury:

1. Use the iron only for its intended use.
2. Check that your mains voltage corresponds to that stated on the appliance.
3. To protect against electrical shock do NOT immerse cord, plugs, or iron in water or other liquid.
4. The temperature dial and steam knob always be turned to 0/MIN before plugging or unplugging from the outlet. Never yank the cord to disconnect from the outlet; instead, grasp the plug and pull to disconnect.
5. Unwind the power cord completely before using.
6. Do not allow the cord to touch the hot surfaces. Let the iron cool down completely before putting away. Rewind the cord completely when storing.
7. Always disconnect the iron from the electrical outlet when filling with water or emptying and when not in use.
8. Do not operate the iron with a damaged cord or plug or after the appliance has been dropped or damaged in any manner. To avoid the risk of electric shock, do not disassemble the iron, take it to a qualified serviceman for examination and repair. Incorrect reassembly can cause a risk of electric shock when the iron is used.
9. Close supervision is necessary when the appliance is used by or near children. Children should NOT play with this appliance. This appliance is not intended for use by persons (including children)



with reduced physical, sensory or mental capabilities, or lack of experience and knowledge, unless they have been given supervision or instruction concerning use of the appliance by a person responsible for their safety.

10. Burns can occur from touching hot metal parts, hot water or steam. Use caution when you turn a steam iron upside down – there may be hot water in the water tank.
11. If the iron is not operating normally, disconnect from the power supply and have the iron serviced by an authorized service center.
12. Deposit or Mineral in tap water will generate limescale and eventually block the steam holes, therefore it is advisable to use distilled water.
13. When placing the iron on a stand, ensure that the surface on which the stand is placed is stable.
14. The iron is not to be used if it has been dropped, if there are visible signs of damage or if it is leaking.

SPECIAL INSTRUCTIONS

- To avoid a circuit overload, do not operate another high wattage appliance on the same circuit.
- If an extension cord is absolutely necessary, a 10-ampere cord should be used. Cords rated for less amperage may overheat. Care should be taken to arrange the cord so that it cannot be pulled or tripped over.

SAVE THESE INSTRUCTIONS

POLARIZED PLUG INSTRUCTIONS

This appliances is equipped with a polarized plug (one blade is wider than the other). To reduce the risk of electric shock, this plug will fit into the polarized outlet only one way. If the plug does not properly fit into the outlet at first, reverse it. If it still does not fit, contact a competent qualified electrician. **Do not attempt to modify the plug in any way.**



PART DESCRIPTION

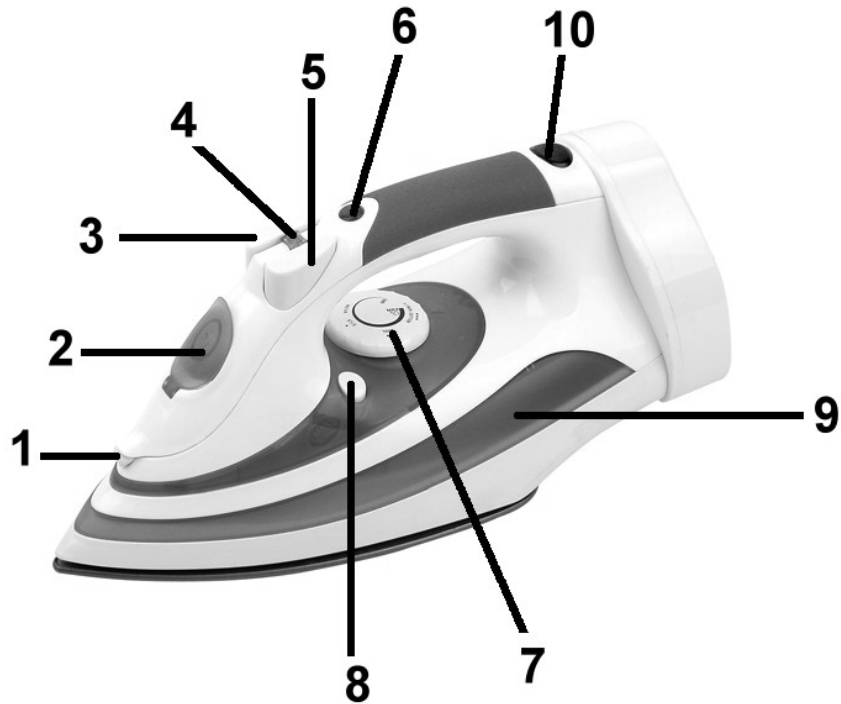

1. Spray nozzle
2. Lid of the filling opening
3. Burst of steam button
4. Steam regulator
5. Spray button
6. Temperature indicator
7. Temperature dial
8. Self-clean button
9. Water tank
10. Cord Rewinding Button



CAUTION BEFORE FIRST USE

- The iron has been greased, and as a result, the iron may slightly smoke when switched on for the first time. After a short while, this will cease.
- Before using for the first time, remove any sticker or protective foil from the soleplate. Clean the soleplate with a soft cloth.
- Keep the soleplate smooth: avoid hard contact with metal objects (such as clothes rack, button and slide fastener).







FILLING THE WATER TANK

- Use preferably demineralized water.
- Make sure the iron is unplugged from the outlet
- Turn the temperature dial to "**MIN**" and the variable steam dial to the "0" setting.
- To fill the water tank, open the lid of the filling opening and pour water through the fill opening, the iron put at an angle of 45°, using the beaker. Never exceed the MAX mark indicated in on the appliance.
- When ironing, unplug the appliance before refilling. Fill the water tank by holding the appliance in 45° angle position without putting down the hot soleplate, unless you have a heat-resistant base.

TEMPERATURE SETTINGS

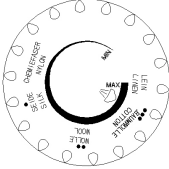
- You can choose the temperature setting in function of the material of cloth to iron.
- In order to turn the iron to the desired temperature, please turn the temperature knob clockwise into the required position (see table below). If you have a doubt, take a look at the garment's label.



Caution: 		Please note that  on the garment label means that this article shall not be ironed.	
Instructions on Label	Type of Fabric	Thermostat dial	
	Nylon Silk	MIN	
	Wool	↑ MAX	
	Cotton Linen		

AUTO SHUT-OFF FEATURE

Your iron is equipped with an auto shut-off feature. This safety measure will shut the iron off when detecting no movement. When in horizontal position, please note that the iron will shut off automatically when no movement is detected during a 30 seconds period. When in vertical position (standing on its heel), please note that the iron will shut off automatically when no movement is detected for 8 minutes.

ANTI DRIP FEATURE

This iron is equipped with an anti drip feature that will protect fabrics from water spotting even at low temperatures.

DRY IRONING

- Unwind the power cord.
- Plug the appliance in the socket.
- Turn the variable steam dial (steam regulator) on position **0**.
- Before running the iron, please classify the clothes as per their label, as it will be quicker for the iron to heat up than to cool, the clothes (such as synthetic fabric, silk etc) with lower ironing temperature shall be ironed first, and then iron the clothes (such as wool, cotton and linen etc) compatible with higher temperature settings
- Put the iron on its end, and turn the thermostat dial to the MIN position.



- Plug in the iron and select the temperature by turning the thermostat dial. If there is water in the reservoir, make sure the steam regulator is set to OFF position. Wait until the indicator light goes off, showing that the required temperature has been reached.

STEAM IRONING

- Fill water in the iron as per the water-filling method above.
- Unwind the power cord.
- Plug the appliance in the socket.
- Set the thermostat dial to MAX position, otherwise water may leak from the soleplate.
- Put the iron on its heel to warm up, until the indicator light goes off.
- Set the steam regulator correctly, increase the steam output by rotating the steam regulator anticlockwise, otherwise decrease the steam output by rotating it clockwise.

Caution: Set the temperature dial within the steam range ('●●' or '●●●'). If temperature setting is too low, water may drip from soleplate.

Check the garment label before ironing because some clothes may be damaged when exposed to steam or water. Typically, synthetic fabrics, nylon, synthetic silk and silk cannot be ironed with steam otherwise it may damage the fabric.

BURST OF STEAM / VERTICAL STEAM

The burst of steam feature  provides additional steam for removing stubborn creases.

- Set the thermostat dial button to MAX, wait until the indicator light goes off.
- Release the steam by pressing the steam button.
- Wait for several minutes and let the steam penetrate through the fabric, and then release more steam through pressing this button again.



Note:

- There should be 3-5 seconds rest between two times of pressing Steam Button in order to obtain the best steaming result.
- Fill the water to the Max position before using this function.
- In order to prevent the water leaking from the soleplate, please do not press the steam button continuously for more than 5 seconds.

This button also allows you to iron delicate articles of clothing vertically. This feature is called "vertical steam". To do so, hang your article of clothing on a hanger, keep the steam button pressed and pass the iron to and fro in front of the article of clothing, making sure that the soleplate does not come into contact with the article of clothing. The distance between the soleplate and the article of clothing depends on the kind of textile and the creases.

SPRAY

- Produces a mist for removing stubborn creases.
- Spray  can be used at any temperature setting and during either dry or steam pressing, provided there is water in the tank. Press down the spray button to spray.

SELF-CLEANING

To remove dirt and dust, the iron should be cleaned at least once a month.

- Fill the iron with water to 1/2 of its maximum capacity. Turn the steam regulator to "0" or "No Steam" position and the thermostat dial to the MIN position. Plug the iron into the mains socket.
- Turn the thermostat dial to Max position.
- Wait until the power indicator light goes off, i.e. the steam iron has reached its preset temperature.
- Hold the iron horizontally over a sink or basin.
- Press the "Self-cleaning button" and hold it down while shaking the iron lightly to eliminate the dirt. The plate gives off hot water and steam.



- During this operation you can press the steam button a number of times, remembering to pause for at least five seconds between one burst of steam and the next.
- When the tank is empty, release the Self-cleaning button.
- At the end, turn the thermostat dial to the MIN position and unplug the iron from the mains socket. Leave the iron to cool and clean the plate with a soft cloth.

RETRACTABLE CORD

- To unwind, simply pull the cord to desired length. Do not try to unwind cord beyond its maximum capacity (See : Fig. 2)
- In case the cord is not pulled out easily, pull cord firmly.
- To rewind the cord, please hold the cord firmly in one hand while pressing and holding the “Cord Release” Button while guiding the cord into the storage area. Failure to hold the plug may cause plug to fly and hit you or objects/persons around you (See : Fig. 3)
- The cord reel is compact, to enable a multi-layer winding of the cord. In case the cord cannot fully rewind, pull out the cord and steer cord evenly on the reel.

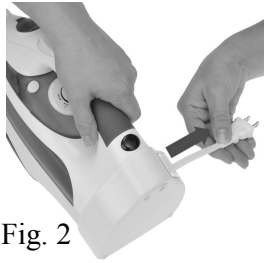

Fig. 2

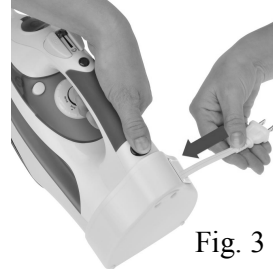

Fig. 3

CAUTION: Always hold the plug while retracting the cord. Do not let the cord retract freely. Cord may jam on reel or loose cord may whip back and forth and could cause injury. Do not allow children to play with the retractable cord feature as the cord may cause injury.



WHEN YOU ARE FINISHED IRONING

- Turn the temperature dial to "**MIN**" and unplug iron from electrical outlet.
- Rewind the power cord.
- With the soleplate facing away from you, turn the iron upside down to empty the water tank.
- Then store the hot iron on its heel so that any remaining moisture will evaporate. When the soleplate has totally cooled down, you may store the iron away.

CARE AND CLEANING

- Clean the iron regularly according to the hardness of the water and the use frequency (see section : SELF CLEANING)
- **Never use vinegar or other liquids to descale the iron internally.**
- To clean the plastic parts of the iron, use a humid cloth.
- To clean the stainless steel soleplate, make sure you use a product made especially for this purpose. Never use abrasive products.
- Wipe off the soleplate with a damp cloth and a non-abrasive (liquid) cleaner.
- If the fiber adheres to the soleplate, use a damp cloth with vinegar to wipe off the soleplate.
- Never use strong acid or alkali in order to avoid damaging the soleplate.
- If limescale blocks the steam hole, please remove it with a toothpick; taking care not to damage the surface of the soleplate.



TROUBLESHOOTING

Iron won't heat	<ul style="list-style-type: none">* Is the iron plugged in and the outlet working? Check the outlet by plugging in a lamp.* Is the Thermostat Dial turned to a fabric setting?
Water is leaking out of the iron	<ul style="list-style-type: none">* Do not overfill the water tank.* If steam ironing, is Steam Regulator in the steam position and the Thermostat Dial in the steam range ? Did the iron have enough time to preheat?* If dry ironing, make sure the Steam Regulator is in the 0 (no steam) position.* If using burst steam, press button less frequently (not more than once every two seconds).* Follow the Self-cleaning instructions one or two times with tap water (not distilled) to "condition" the iron.
Iron won't steam	<ul style="list-style-type: none">* Check the water level.* Is the Steam Regulator in the STEAM position?* Has the iron had enough time to preheat?
Iron leaves spots on clothing	<ul style="list-style-type: none">* ALWAYS empty the Water Reservoir of the iron after using. Water left in the tank may discolor clothing and soleplate.
Wrinkles not removed	<ul style="list-style-type: none">* Check Thermostat Dial is set to correct fabric.
Fabric/Clothing scorched	<ul style="list-style-type: none">* Check Thermostat Dial and set to lower setting.* Allow iron to cool down 5 minutes before continuing.
Twisted cord	<ul style="list-style-type: none">* If iron cord should become twisted, turn iron off (o), turn Thermostat Dial to MIN (o) and unplug iron. Let cool. Empty water from iron. Hold iron cord in the middle of entire length. Let plug and iron dangle freely until cord uncoils. This will extend the life of your iron cord.



WARRANTY

We suggest that you complete and return the enclosed Product Registration Card promptly to facilitate verification of the date of original purchase. However, return of the Product Registration Card is not a condition of these warranties. You can also fill this warranty card online, at the following address: www.KALORIK.com

This KALORIK product is warranted for 1 year from the date of purchase against defects in material and workmanship. This warranty is not transferable. Keep the original sales receipt. Proof of purchase is required to obtain warranty performance.

During this period, the KALORIK product that, upon inspection by KALORIK, is proved defective, will be repaired or replaced, at KALORIK's option, without charge to the customer. If a replacement product is sent, it will carry the remaining warranty of the original product.

This warranty does not apply to any defect arising from a buyer's or user's misuse of the product, negligence, failure to follow KALORIK instructions noted in the user's manual, use on current or voltage other than that stamped on the product, wear and tear, alteration or repair not authorized by KALORIK, or use for commercial purposes. There is no warranty for glass parts, glass containers, filter basket, blades and agitators, and accessories in general. There is also no warranty for parts lost by the user.

ANY WARRANTY OF MERCHANTABILITY OR FITNESS WITH RESPECT TO THIS PRODUCT IS ALSO LIMITED TO THE ONE YEAR LIMITED WARRANTY PERIOD

Some states do not allow limitation on how long an implied warranty lasts or do not allow the exclusion of incidental or consequential damages, so the above limitations may not apply to you. This warranty gives you specific legal rights, and you may also have other rights which vary from state to state.



If the appliance should become defective within the warranty period and more than 30 days after date of purchase, do not return the appliance to the store: often, our Consumer Service Representatives can help solve the problem without having the product serviced. If servicing is needed, a Representative can confirm whether the product is under warranty and direct you to the nearest service location.

If this is the case, bring the product (or send it, postage prepaid), along **with proof of purchase** and indicating a **return authorization number** given by our Consumer Service Representatives, to the nearest authorized KALORIK Service Center (please visit our website at www.KALORIK.com or call our Customer Service Department for the address of the nearest authorized KALORIK Service Center). If you send the product, please include a letter explaining the nature of the claimed defect.

If you have additional questions, please call our Consumer Service Department (please see below for complete contact information), Monday through Friday from 9:00am - 6:00pm (EST). Please note hours are subject to change.

If you would like to write, please send your letter to:

KALORIK Consumer Service department
Team International Group of America Inc
1400 N.W 159th Street, Suite 102
Miami Gardens, FL 33169 USA

Or call :

Toll Free: +1 888-521-TEAM

Only letters can be accepted at this address above. Shipments and packages that do not have a return authorization number will be refused.

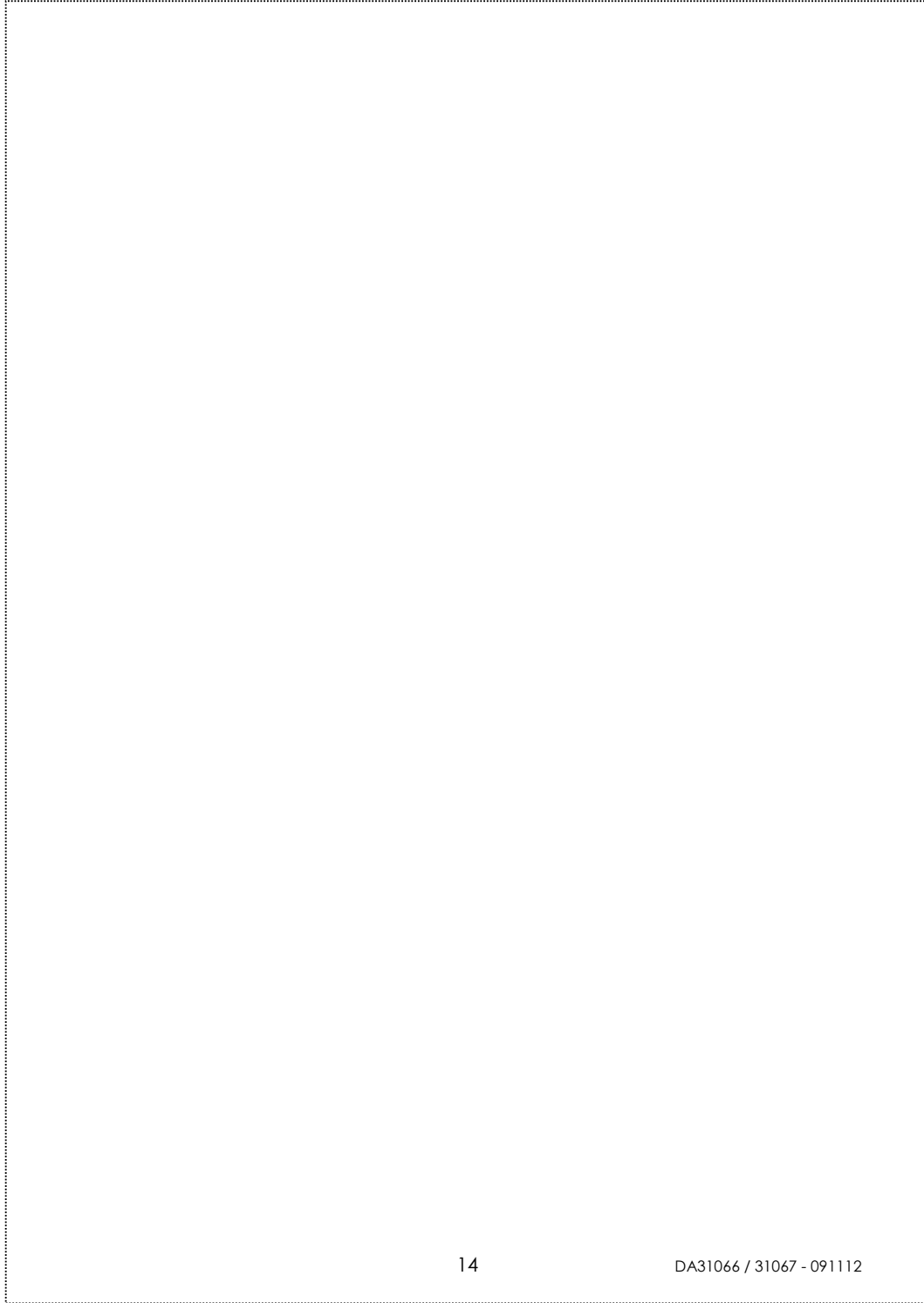

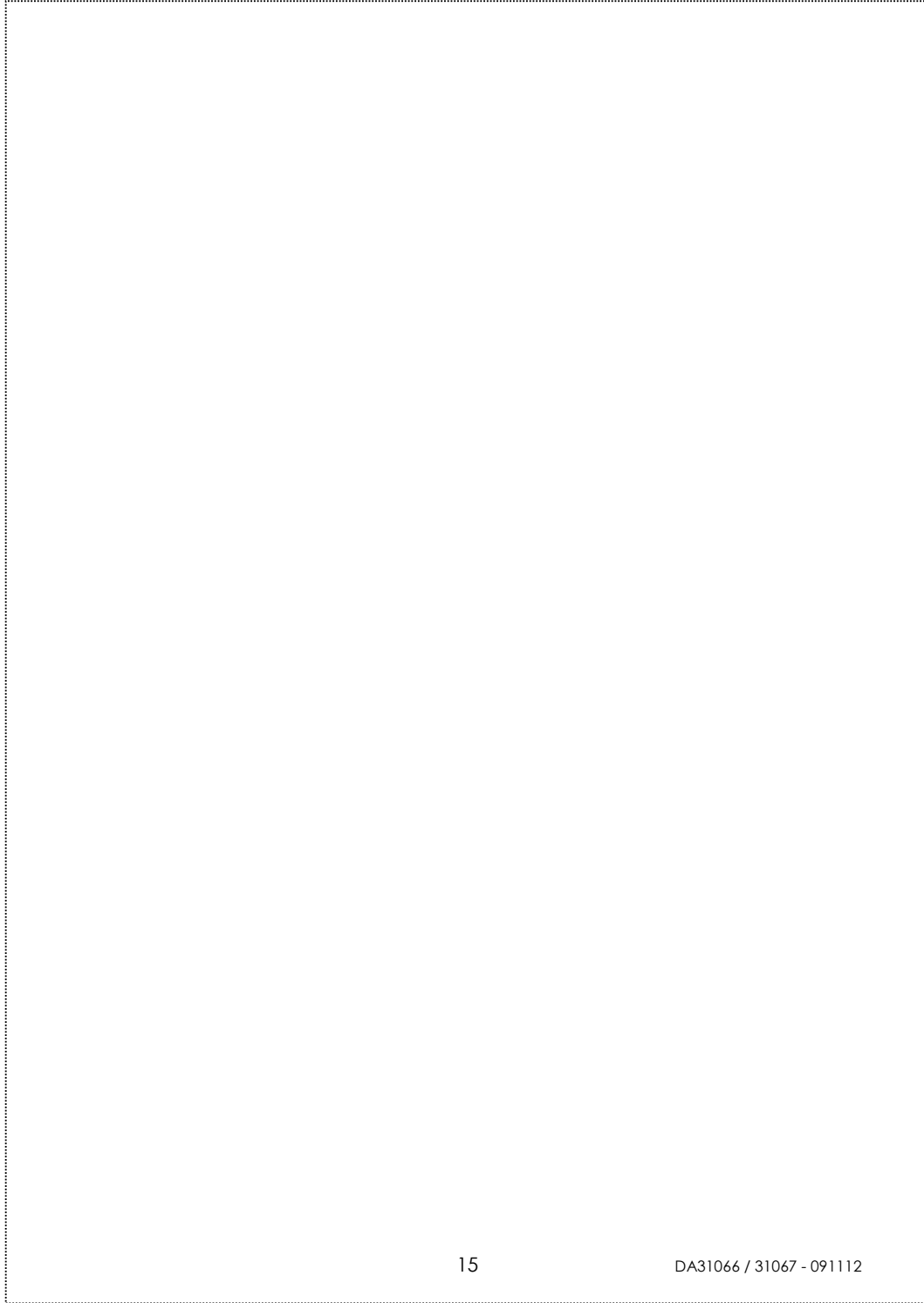

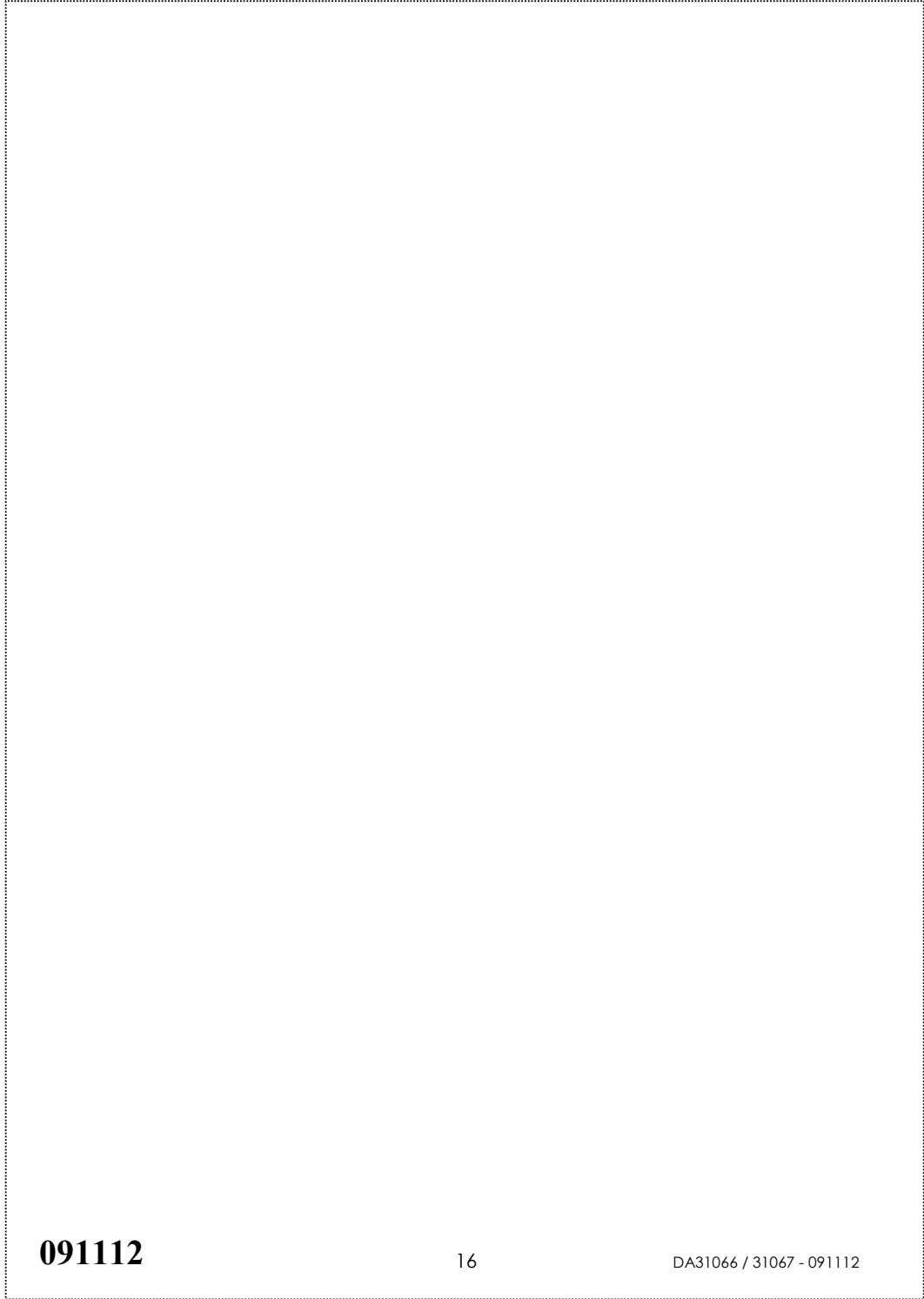

091112

16

DA31066 / 31067 - 091112