

FREEMAN

- [HTTP://WWW.FREEMANTOOLS.COM](http://www.freemantools.com)
- 1-888-669-5672
- PRIME GLOBAL PRODUCTS, INC



FREEMAN

MODEL: PFR2190

21° 3-1/2" FULL ROUND HEAD FRAMING NAILER

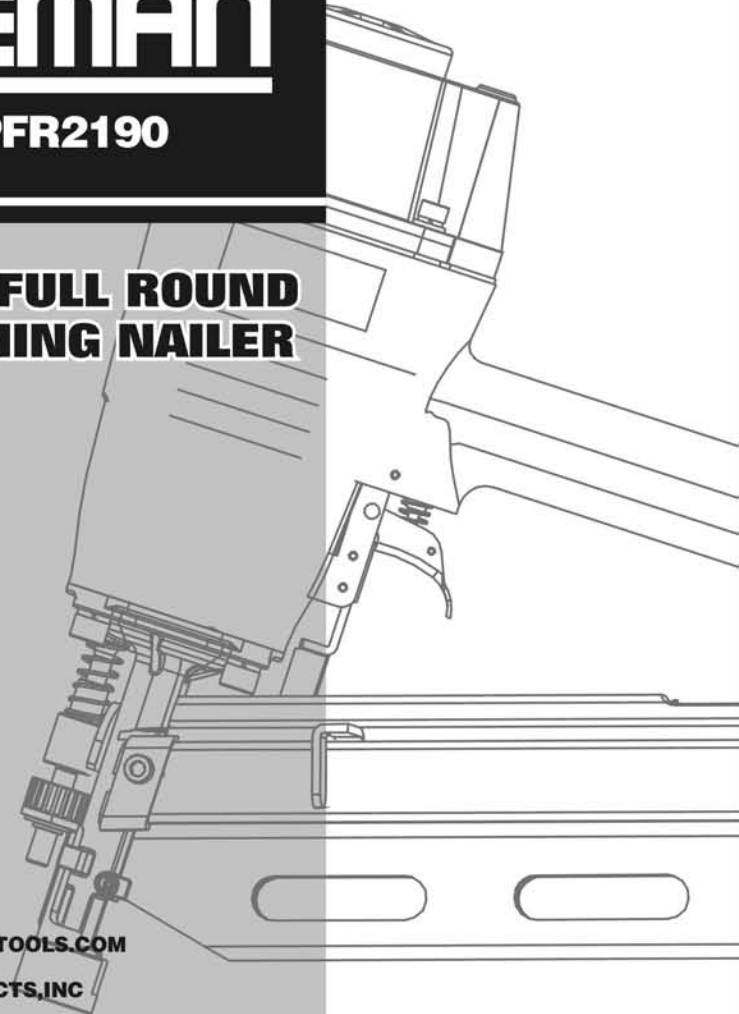

- [HTTP://WWW.FREEMANTOOLS.COM](http://www.freemantools.com)
- 1-888-669-5672
- PRIME GLOBAL PRODUCTS, INC



WARNING:

Failure to follow warnings could result in DEATH OR SERIOUS INJURY.

SAVE THIS MANUAL FOR FUTURE REFERENCE

GENERAL SAFETY RULES	P1
UNPACKING	P3
FEATURES	P3
OPERATION	
ADJUSTING THE EXHAUST	P4
LOADING FASTENERS	P4
UNLOADING FASTENERS	P5
CLEARING JAMS	P5
NO-MARRING PAD	P5
SETTING THE AIR PRESSURE	P5
DEPTH ADJUSTMENT	P5
FIRING THE TOOL	P6
MAINTENANCE	P7
RECOMMENDED HOOKUP	P8
TROUBLE SOLVING	P8
WEARING PARTS	P8

WARNING:

The warnings and precautions discussed in the manual cannot cover all possible conditions and situations that may occur. It must be understood by the user that common sense and caution are factors which cannot be built into this product, but must be supplied by the user.

SAVE THIS MANUAL



- Keep this manual for the safety warnings and precautions, operating, inspection, maintenance. Keep this manual and the receipt in a safe and dry place for future reference.

WARNING:

To avoid serious personal injury, do not attempt to use this product until you read thoroughly and understand completely this manual. Save this manual and review frequently for continuing safe operation and instructing others who may use this tool.

SYMBOLS

- In this manual, on the labels, packages and all other information provided with this tool. The following signal words and meanings are intended to explain the levels of risk associated with this tool.

SYMBOLS	SIGNAL	MEANING
	WARNING:	Indicates a potentially hazardous situation, which, if not avoided, could result in death or serious injury.
	CAUTION:	Indicates a potentially hazardous situation, which, if not avoided, may result in minor or moderate injury.
	CAUTION:	(Without symbol) Indicates a situation that may result in property damage.

GENERAL SAFETY RULES**WORK AREA**

- **Keep the work area clean and well lighted.** Cluttered benches and dark areas increase the risks of accidents.
- **Do not operate the tool in explosive atmospheres, such as in the presence of flammable liquids, gases, or dust.** The tool creates a spark which may ignite flammable liquids, gases or dust.
- **Keep bystanders, children, and others away while operating the tool.** Distractions could result in improper use and cause injury.
- **Avoid unintentional misfires.** Always use caution to avoid accidentally firing. Do not point towards yourself or anyone whether it contains fasteners or not.

PERSONAL SAFETY

- **Always wear eye protection.** Operator and others in the work area should always wear ANSI-approved safety goggles with side shields. Eye protection is used to guard against flying fasteners and debris, which may cause severe eye injury. You can use the goggles packed with the tool.
- **Always wear hearing protection when using the tool.** Prolonged exposure to high intensity noise may cause hearing loss.

- **Use safety equipment.** A dust mask, non-skid safety shoes and a hard hat must be used for the applicable conditions. Wear a full face shield if you are producing metal filings or wood chips.
- **Dress properly.** Do not wear loose clothing or jewelry. Contain long hair. Keep your hair, clothing, and gloves away from moving parts. Loose clothes, jewelry, or long hair can be caught in moving parts.
- **Stay alert, watch what you are doing and use common sense when operating a power tool.** Do not use tool while tired or under the influence of drugs, alcohol, or medication. A moment of inattention while operating the tool may cause serious injury.
- **Avoid unintentional firing.** Keep fingers away from trigger when not driving fasteners, especially when connecting the tool to the air supply.
- **Keep proper footing and balance at all times.** Proper footing and balance enables better control of the tool in unexpected situations.
- **Do not use on a ladder or unstable supports.** Stable footing on a solid surface enables better control of the tool in unexpected situations.
- **Make sure the hose is free of obstructions or snags.** Entangled or snarled hoses can cause loss of balance or footing and may become damaged, resulting in possible injury.

TOOL USE AND CARE

- **Know this tool.** Read manual carefully, learn its applications and limitations, as well as the specific potential hazards related to this tool.
- **Use only fasteners that are recommended for your models.** Do not use the wrong fasteners or load the fasteners incorrectly.
- **Check for misalignment or binding of moving parts, breakage of parts, and any other condition that may affect the tool's operation.** If damaged, have the tool serviced before using. Many accidents are caused by poorly maintained tools.
- **Maintain tools with care.** Keep tool clean. A properly maintained tool, reduces the risk of binding and is easier to control.
- **Store tools out of the reach of children and other untrained people.** Tools are dangerous in the hands of untrained users.
- **Check operation of the tool before use.** Do not use the tool if the workpiece contact mechanism is not working correctly as accidental driving of a fastener may occur.
- **Do not use tool if trigger does not actuate properly.** Any tool that cannot be controlled with the trigger is dangerous and must be repaired.
- **Do not force tool.** Use the correct tool for your application. The correct tool will do the job better and safer at the rate for which it is designed.
- **Use clamps or another practical way to secure and support the workpiece to a stable platform.** Holding a tool by hand or against the body is unstable and may lead to loss of control.
- **Keep the tool and its handle dry, clean and free from oil and grease.** Always use a clean cloth when cleaning. Never use brake fluids, gasoline, petroleum-based products, or any strong solvents to clean your tool.
- **Do not use the tool as a hammer.**
- **Never use this tool in a manner that could cause a fastener to be directed toward anything other than the workpiece.**
- **Always carry the tool by the handle. Never carry the tool by the air hose.**
- **Do not use the tool if it leaks air or does not function properly.**
- **Do not operate the tool if it does not contain a legible warning label.**

TOOL SERVICE

- **Use only accessories that are identified by the manufacturer for the specific tool model.**
- **Use of unauthorized parts or failure to follow maintenance instructions may create a risk of injury.**
- **Use only the lubricants supplied with the tool or specified by the manufacturer.**
- **Tool service must be performed only by qualified repair personnel.**

OPERATION

- **Do not drive fasteners near edge of material.** The workpiece may split causing the fastener or ricochet, injuring you or people around.
- **Do not carry the tool from place to place holding the trigger. Accidental discharge could result.** Choice of triggering method is important. Check manual for triggering options.
- **During normal use the tool will recoil immediately after driving a fastener.** This is a normal function of the tool. Do not attempt to prevent the recoil by holding the tool against the work. Restriction to the recoil can result in a second fastener being driven from the tool. Grip the handle firmly and let the tool do the work. Failure to heed this warning can result in serious personal injury.
- **Do not drive fasteners on top of other fasteners or with the tool at an overly steep angle as this may cause deflection of fasteners which could cause injury.**
- **Do not actuate the tool unless you intend to drive a fastener into the workpiece.**
- **Always handle the tool with care:**
 - ◆ Respect the tool as a working implement.
 - ◆ Never engage in horseplay.
 - ◆ Never pull the trigger unless nose is directed toward the work.
 - ◆ Keep others a safe distance from the tool while tool is in operation as accidental actuation may occur, possibly causing injury.

AIR SUPPLY AND CONNECTIONS

- **The connector on the tool must not hold pressure when air supply is disconnected.** If an incorrect fitting is used, the tool can remain charged with air after disconnecting and thus will be able to drive a fastener even after the air line is disconnected, possibly causing injury.

PACKING LIST

Framing nailer
Carrying case
Air connector
Adjustment tools
Lubricating oil
Instruction manual
Safety goggles
Anti-dust cap
Framing nailer

▲ **WARNING:**

If any parts are missing do not operate this tool until the missing parts are replaced. Failure to do so could result in possible serious personal injury.

▲ **WARNING:**

Do not attempt to modify this tool or create accessories not recommended for use with this tool. Any such alteration or modification is misuse and could result in hazardous condition leading to possible serious personal injury.

LOADING TOOL

- Do not load the tool with fasteners when any one of the operating controls is activated.
- Never place a hand or any part of body in fastener discharge area of tool.
- Never point tool at anyone.
- Do not pull the trigger or depress the workpiece contact as accidental actuation may occur, possibly causing injury.

▲ **WARNING:**

The warnings and precautions discussed above cannot cover all possible conditions and situations that may occur. It must be understood by the user that common sense and caution are factors which cannot be built into this product, but must be supplied by the user.

UNPACKING

- This tool has been shipped completely assembled.
- Make sure that all items listed in the packing list are included.
- Carefully remove the tool and any accessories from the box.
- Inspect the tool carefully to make sure no breakage or damage occurred during shipping.
- Do not discard the packing material until you have carefully inspected and satisfactorily operated the tool.
- If any parts are damaged or missing, please call 1-888-669-5672.

FEATURES

SPECIFICATIONS

Operation pressure: 70–115psi
Nails capacity: 55pcs
Tool weight: 8.6 lbs
Air inlet: 1/4"NPT
Fasteners:

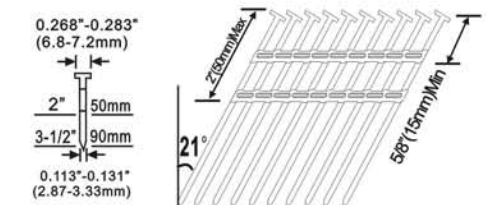

Compatible with Hitachi, DeWalt, Porter Cable, Duo-Fast, Senco, & Generic Brand Plastic Collated 21° Full Head Framing Nails.

FEATURES

- **360° ADJUSTABLE EXHAUST**
Allows user to direct air away from debris.
- **OIL-FREE DESIGN**
For less maintenance.
- **ONE PIECE DRIVER BLADE**
For increased durability.
- **ANODIZED ALUMINUM CYLINDER AND MAGAZINE**
For long lasting durability.
- **COMFORT-GRIP HANDLE**
For increased comfort and control.
- **MAGNESIUM BODY**
Light-weight tool great for extended use.
- **AIR FILTER**
Keeps interior components debris free, extending tool life.
- **DUAL-MODE TRIGGER**
Easily allows for Single or Sequential Firing.
- **ADJUSTABLE DEPTH**
Depth is easily adjustable for various applications.
- **ANTI-DRY-FIRING DESIGN**
Reduces damage on internal components.
- **NON-MARRING SAFETY CONTACT**
Eliminates damage to working surfaces.

OPERATION

ADJUSTING THE EXHAUST

The adjustable exhaust on the cap of the tool allows users to direct the exhaust according to operator preference. To adjust the direction, turn the exhaust cap in the desired direction.

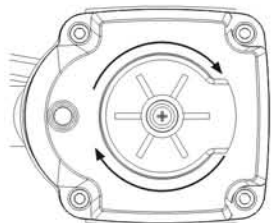

LOADING FASTENERS

1. Connect the tool to the air resource.
2. Pull pusher(A) back until the fasteners follow falls behind the fasteners. Insert strip of fasteners into the notch upon the magazine(B). Be sure the fasteners are pointed downward.
3. Press the latch, then pull pusher to let it go back to move the fasteners up to the driving mechanism. The pusher will stop when it rests against the end of the fastener.

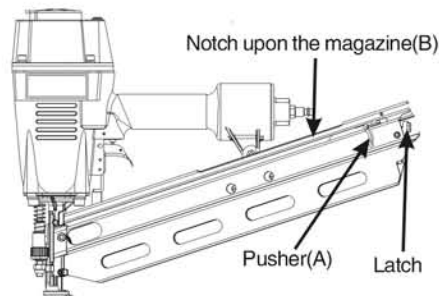
▲ **WARNING:**

The tool may fire when it first connected to the air resource. Always connect the tool to the air resource before loading fasteners to prevent injury from unintended cycling. Always make sure the tool's magazine is empty at the beginning of each work session, before connecting to an air resource.

▲ **WARNING:**

Use only the fasteners recommended for use with this tool. The use of any other fasteners could result in tool malfunction, leading to serious injuries.

▲ **WARNING:**

Keep the tool pointed away from yourself and others when loading fasteners. Failure to do so could result in possible serious personal injury.

▲ **WARNING:**

Never load fasteners with the workpiece contact or trigger activated. Doing so could result in possible serious personal injury.

UNLOADING FASTENERS

Unloading is the reverse of loading, except always disconnect the air resource before unloading.

▲ **WARNING:**

Always unload all fasteners before removing tool from service.

▲ **WARNING:**

Always disconnect the air resource before unloading.

CLEARING JAMS

Occasionally, a fastener may become jammed in the firing mechanism of the tool, making the tool inoperable. To remove a jammed fastener, follow the steps below:

1. Disconnect the tool from air resource.
2. Remove fasteners from the tool. Failure to do so will cause the fasteners to eject from the front of the tool.
3. Pull the jammed fastener out from the nose, use pliers or a screwdriver if required to clear the jammed fastener. Using caution not to bend or damage the driver blade.
4. Reconnect the tool to the air resource.
5. Reload the tool with fasteners.

▲ **WARNING:**

Make sure there is no fastener in magazine before clearing a jam.

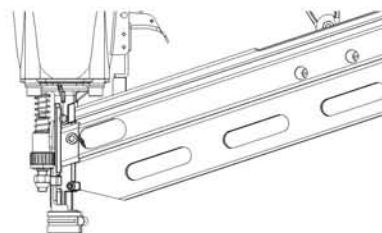
▲ **WARNING:**

Disconnect the tool from the air source whenever clearing a jam. After disconnecting the tool from the air compressor, there should still be enough air pressure to fire the tool. After the air hose is disconnected, always fire the tool into scrap wood repeatedly to make sure all of the compressed air is expended.

NO-MARRING PAD

The no-marring pad attached the nose of the tool helps prevent marring and denting when working with softer woods.

▲ **WARNING:**

Disconnect the tool from the air resource before removing or replacing the no-marring pad or replacing the no-marring pad. Failure to do so could result in serious personal injury.

SETTING THE AIR PRESSURE

The amount of air pressure required depends on the size of the fasteners and the workpiece material. Begin testing the depth of drive by driving a test nail into the same type of workpiece material used for the actual job. Drive a test fastener with the air pressure set at 90–95psi. Raise or lower the air pressure to find the lowest setting that will perform the job with consistent results. It may be possible to achieve the desired depth with air pressure adjustments alone.

DEPTH ADJUSTMENT

The driving depth of the fasteners are adjustable. To adjust the depth, use the drive depth adjustment wheel(C) on the tool.

1. Disconnect the tool from the air resource.
2. Turn the depth wheel left or right to change the driving depth.
3. Reconnect the tool to the air resource.
4. Drive a test nail after each adjustment until the desired depth is set.

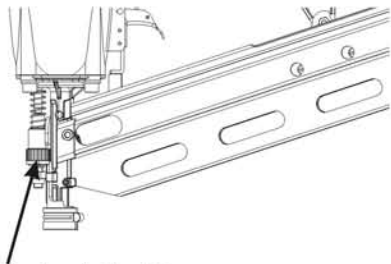

Adjustment wheel(C)

CAUTION:

It is advisable to test the depth on a scrap workpiece to determine the required depth for the application. To determine depth of drive, first adjust the air pressure and drive a test fastener. Never exceed 120psi.

**FIRING THE TOOL
(USING THE SELECTABLE TRIGGER)**

The tool is equipped with a selectable trigger set in the single sequential actuation mode (black trigger). The selectable trigger (orange trigger) can also be set for contact actuation mode.

SINGLE SEQUENTIAL ACTUATION MODE

Single sequential actuation provides the most accurate fastener placement.

1. Disconnect the tool from the air resource.
2. Remove the o-ring from the trigger pin(D).
3. Pull the trigger pin(D) out.
4. Put the black trigger on.
5. Push the trigger pin(D) back, using a little hammer if necessary. Use Caution not to damage the tool when reinserting the trigger pin.
6. Put the o-ring back to fasten the trigger pin(D).
7. Grip the tool firmly to maintain control. Position the nose of the tool onto the work surface.
8. Push the tool against the work surface to depress the workpiece contact.
9. Squeeze the trigger to drive a fastener.

CONTACT ACTUATION MODE

Contact actuation allows very fast repetitive fastener placement.

1. Disconnect the tool from the air resource.
2. Remove the o-ring from the trigger pin(D).
3. Pull the trigger pin(D) out.
4. Put the orange trigger on.
5. Push the trigger pin(D) back, using a little hammer if necessary.
6. Put the o-ring back to fasten the trigger pin(D).
7. Grip the tool firmly to maintain control. Position the nose of the tool onto the work surface.
8. Squeeze and hold the trigger, push the tool against the work surface to depress the workpiece contact and drive a fastener.

NOTE:

In the contact actuation mode, the tool may also be operated by depressing the workpiece contact against the surface and squeezing the trigger.

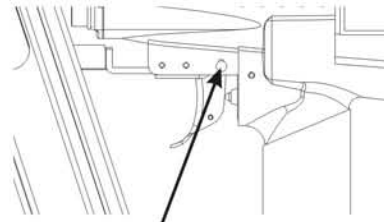

Trigger pin(D)

WARNING:

During normal use the tool will recoil immediately after driving a fastener. This is a normal function of the tool. Do not attempt to prevent the recoil by holding the tool against the work. Restriction to the recoil can result in a second fastener being driven from the tool. Grip the handle firmly and let the tool do the work. Failure to heed this warning can result in serious personal injury.

MAINTENANCE**WARNING:**

Any time inspection, maintenance, and cleaning are done:

- ◆ Disconnect the tool from the air resource.
- ◆ Empty the magazine completely.

ANTI-DUST

Each FREEMAN tool is packed with an anti-dust cap on the air connector.

Keep the anti-dust cap cover the air connector when the tool is not in use.

LUBRICATION

The tool is uniquely designed not to need daily lubrication. But lubrication is required for best performance after long periods use. Oil for pneumatic fastening tools is added through the air line connection and will lubricate internal parts. Do not use detergent oil or additives as these lubricants will cause accelerated wear to the seals and bumpers in the tool, resulting in poor tool performance and frequent tool maintenance.

CAUTION:

Lubricate tool only with specified lubricants.

CLEARING

Avoid using solvents when cleaning plastic parts. Most plastics are susceptible to damage from various types of commercial solvents and maybe damaged by their use. Use clean cloths to remove dirt, dust, oil, grease, etc.

WARNING:

Do not at any time let brake fluids, gasoline, petroleum-based products, penetration oils, ect. come in contact with plastic parts. Chemicals can damage, weaken or destroy plastic which may result in serious personal injury.

COLD WEATHER OPERATION

For cold weather operation, near and below freezing, the moisture in the air line may freeze and prevent tool operation. We recommend the use of air tool lubricant or permanent antifreeze (ethylene glycol) as a cold weather lubricant.

CAUTION:

Do not store tools in a cold weather environment to prevent frost or ice formation on the tool's operating valves and mechanisms that could cause tool failure.

RECOMMENDED HOOKUP

CAUTION:

The air compressor must be able to maintain a minimum of 70psi when the tool is being used. An inadequate air supply can cause a loss of power and inconsistent driving.

WARNING:

Do not connect with an air compressor which can potentially exceed 200psi. As tool may burst, possibly causing injury.

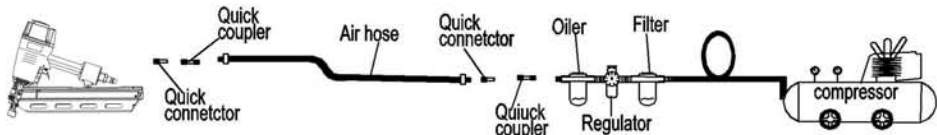

TROUBLE SOLVING

PROBLEMS	POSSIBLE CAUSES	SUGGESTED SOLUTIONS
Air leaking near the top of the tool or in the trigger area.	1. Loose screws. 2. Worn or damaged O-rings or seals.	1. Tighten screws. 2. Install overhaul kit.
Air leaking near the bottom of the tool.	1. Loose screws. 2. Worn or damaged O-rings or seals.	1. Tighten screws. 2. Install overhaul kit.
Tool does nothing or operates sluggishly.	1. Inadequate air supply. 2. Tool is too dry. 3. Exhaust blocked. 4. Worn or damaged O-rings or seals.	1. Make sure the air compressor is set between 70psi and 115psi. 2. Add about 2-3 drops of lubrication into the air connector. 3. Clean exhaust channel. 4. Install overhaul kit.
Fasteners are jammed in the tool frequently.	1. Drive channel is worn. 2. Piston is broken or worn. 3. Bent fasteners. 4. Dirty magazine. 5. Loose magazine. 6. Wrong fasteners.	1. Fix the drive channel. 2. Replace the piston. 3. Remove the bent fasteners, replace with the right fasteners. 4. Clean magazine. 5. Tighten screws. 6. Verify that fasteners are the correct size.
Can not fire the tool	There is no fastener in the magazine.	load the fasteners.

WARNING:

Use only Freeman Authorized Repair Parts. For questions please call 1-888-669-5672 or visit our website at <http://www.freemantools.com>

WEARING PARTS

Repair parts can be ordered from our website: <http://www.freemantools.com>

MEMO:
