

The Hisense logo is displayed in a bold, white, sans-serif font against a dark grey background. The background of the entire page features a series of overlapping, curved, light grey bands that create a sense of motion and depth, starting from the bottom left and curving towards the top right.

Hisense

life reimagined

Compact Double Door Refrigerator

Owner's manual

Before operating this unit, please read this manual thoroughly, and retain for future reference

English

Model: RT33D6AAE

COPYRIGHT STATEMENT

© 2015 Hisense Company Ltd. All Rights Reserved.

All material in this Owner's Manual is the property of Hisense Company Ltd. and its subsidiaries, and is protected under US and International copyright and/or other intellectual property laws. Reproduction or transmission of the materials, in whole or in part, in any manner, electronic, print, or otherwise, without the prior written consent of the Hisense Company Ltd. is a violation of Hisense Company Ltd. rights under the aforementioned laws. No part of this publication may be stored, reproduced, transmitted or distributed, in whole or in part, in any manner, electronic or otherwise, whether or not for a charge or other or no consideration, without the prior written permission of Hisense Company Ltd.

Requests for permission to store, reproduce, transmit or distribute materials may be made to the following address:

Hisense USA Corporation
PO Box 3289
Suwanee, GA 30024

Hisense, and any and all other Hisense product names, logos, slogans or marks are registered trademarks of Hisense Company Ltd. and its subsidiaries. All other trademarks are the property of their respective holders.

IMPORTANT SAFETY INSTRUCTIONS

Please follow the precautions below for your new refrigerator:

1. This refrigerator must be properly installed and located in accordance with the Installation Instructions before it is used.
2. Do not allow children to climb, stand or hang on the shelves in the refrigerator. They could damage the refrigerator and seriously injure themselves.
3. Do not store or use gasoline or other flammable vapors and liquids in the vicinity of this or any other appliance.
4. Keep fingers out of the clearances between the doors and cabinet. Be careful closing doors when children are in the area.
5. Unplug the refrigerator before cleaning and making repairs.
6. Service should **ONLY** be performed by Hisense-authorized professional Warranty Service Centers.
7. Turning the temperature control dial to the "OFF" position stops cooling but does not shut off power to the refrigerator.
8. Do not leave the refrigerator in extreme cold or warm temperatures.
9. Do not place the refrigerator near heat sources or open flames.
10. Clean the refrigerator with a soft, damp cloth. Remove stains with a mild soap. Do not clean the unit with industrial grade solvents, or abrasive chemicals.
11. Do not place heavy items on top of the refrigerator.
12. Never install the refrigerator where there is a lot of moisture and water can splash.
13. Do not allow children to hang on the doors because the refrigerator may be tipped over and hurt children.
14. Never eat spoiled food stored too long in the refrigerator or in an out-of-order refrigerator.
15. To prevent damage to the refrigerator, do not use sharp tools inside of it to remove ice or other actions.
16. Unplug and remove food from the refrigerator if not used for a long period of time.
17. **CAUTION!**
This refrigerator contains flammable refrigerant. Avoid damaging the refrigerant tubing or increasing the risk of a leak when handling, moving and using the refrigerator.
18. The refrigerant isobutene (R600a) is contained within the refrigerant circuit of the appliance, a natural gas with a high level of environmental compatibility, which is nevertheless flammable. During transportation and installation of the appliance, ensure that none of the components of the refrigerant circuit becomes damaged. The refrigerant (R600a) is flammable.

PROPER DISPOSAL

An empty refrigerator is an extremely dangerous attraction to children. If you are getting rid of your old refrigerator, please follow the instructions in the Child Entrapment Warning.

CHILD ENTRAPMENT WARNING:

Risk of child entrapment. Before you throw away your old refrigerator or freezer:

1. Take off the doors.
2. Leave the shelves in place so that children may not easily climb inside.

CAUTION: We do not recommend that you use an extension cord with this appliance.

**FOR HOUSEHOLD USE ONLY
SAVE THESE INSTRUCTIONS**

GROUNDING INSTRUCTIONS

This appliance must be grounded. In the event of an electrical short circuit, grounding reduces the risk of electric shock by providing an escape wire for the electric current. This appliance is equipped with a cord having a grounding wire with a grounding plug. The plug must be inserted into an outlet that is properly installed and grounded.

WARNING: Improper use of the grounding plug can result in a risk of electric shock. Consult a qualified electrician or service person if the grounding instructions are not completely understood, or if doubt exists as to whether the appliance is properly grounded.
If it is necessary to use an extension cord, use only a three wire extension cord that has a three blade grounding plug, and a three slot receptacle that will accept the plug on the appliance. The marked rating of the extension cord should be equal to or greater than the electrical rating of the appliance.

INSTALLATION

1. Steady, flat location:

If the refrigerator is not leveled during installation, the doors may not close or seal properly, causing cooling, frost, or moisture problems. It is very important for the refrigerator to be level in order to function properly.

To level your refrigerator, you may either turn the level leg clockwise to raise that side to the refrigerator or turn counter-clockwise to lower that side. Having someone push against the top of the refrigerator will take some weight off the leveling leg. This makes it easier to adjust the leveling leg.

2. Ventilation:

Place refrigerator approximately 5 inches from the wall to ensure proper airflow to the compressor. Do not place refrigerator near any heat resources such as a heater or stove as it will put a strain on the compressor.

3. Power supply:

- Check your local power source. This refrigerator requires a 110V-120V, 60Hz power supply.
- Use a receptacle that will accept the ground prong. The power cord of this appliance is equipped with a 3-prong (grounding) plug which mates with a standard 3-prong (grounding) wall outlet to minimize the possibility of electric shock hazard from this appliance.

(a) Longer cord sets or extension cords are available and may be used if care is exercised in their use.

(b) Use of an extension cord is not recommended, (1) the marked electrical rating of the cord set or extension cord should be at least as great as the electrical rating of the appliance,

(2) the extension cord must be a grounding-type 3-wire cord, and (3) the longer cord should be arranged so that it will not drape over the counter top or table top where it can be pulled

on by children or tripped over unintentionally.

NOTES:

The refrigerator should always be plugged into its own individual electrical outlet which has a voltage rating that matches the rating plate.

If you have only a standard 2-prong wall outlet, it is your personal responsibility and obligation to have it replaced with a properly grounded 3-prong wall outlet.

Never unplug your refrigerator by pulling on the power cord. Always grip plug firmly and pull straight out from the outlet.

When using a 3-pronged plug

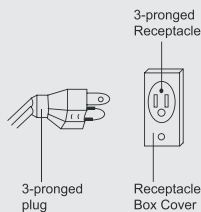

When using a grounding adapter, make sure the receptacle box is fully grounded.

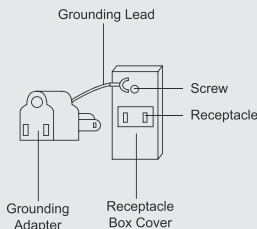

LOCATION OF CONTROLS

DOOR CLOSED

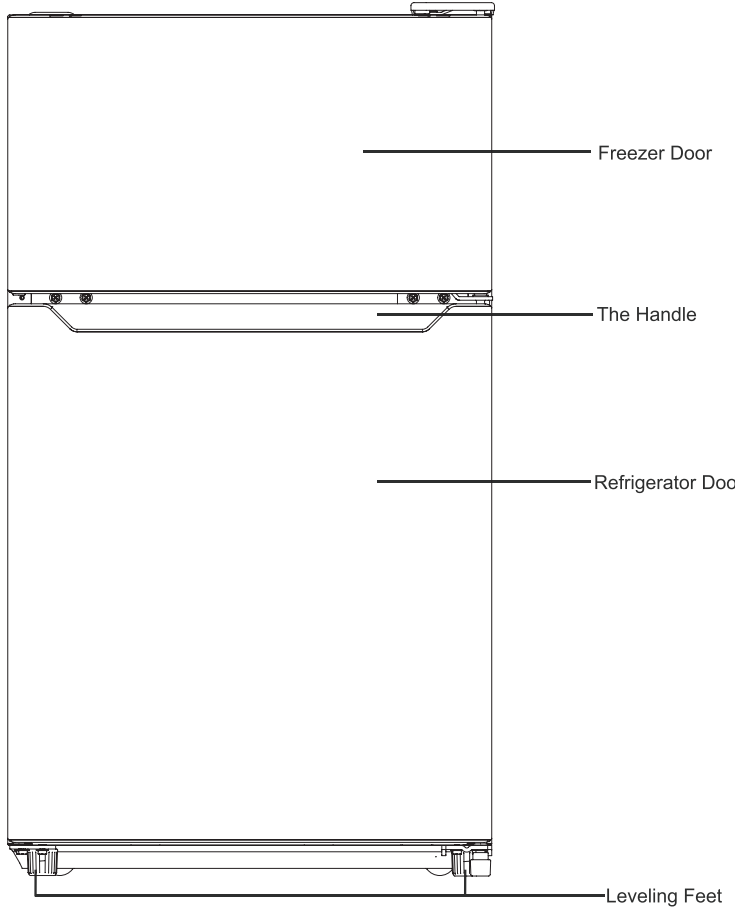

1. Freezer Door
2. The Handle
3. Refrigerator Door
4. Leveling Feet

LOCATION OF CONTROLS (CONTINUED)

DOOR OPEN

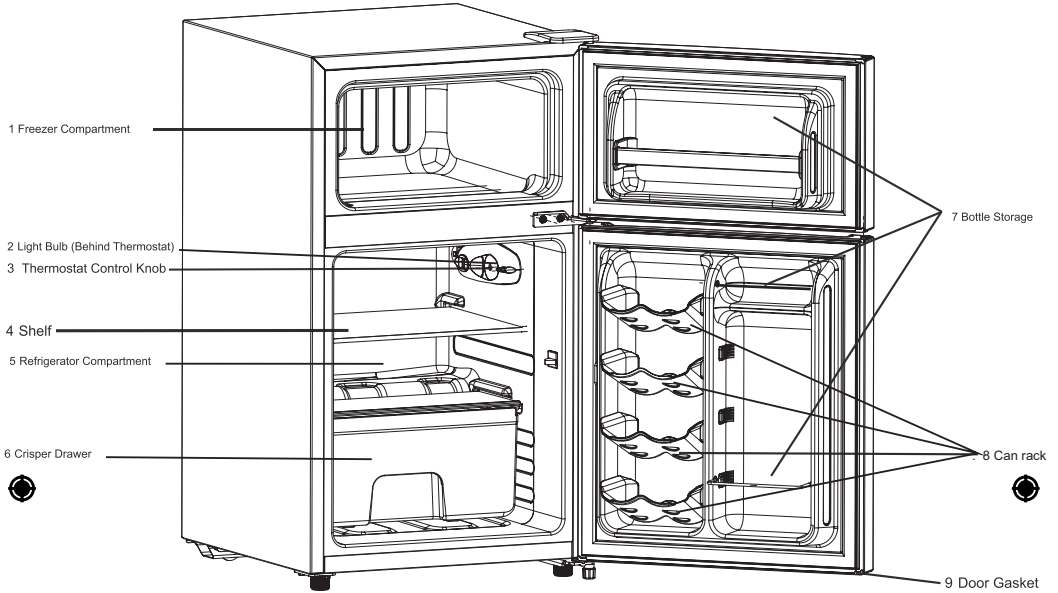

1. Freezer Compartment
2. Light Bulb (Behind Thermostat)
3. Thermostat Control Knob
4. Shelf
5. Refrigerator Compartment
6. Crisper Drawer
7. Bottle Storage
8. Can rack

OPERATION

USING THE THERMOSTAT

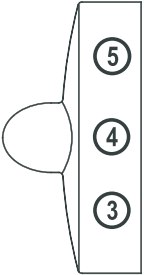
<p style="text-align: center;">Temp Control</p> <p>Thermostat control dial</p>  <p>The diagram shows a thermostat control dial with three numbered positions: 3, 4, and 5. The dial is a semi-circle with a knob on the left side. The numbers are inside circles on the right side of the dial.</p>	<p>The thermostat control knob for the refrigerator and freezer is located at the upper right hand corner of the refrigerator compartment.</p> <p>The first time you turn the unit on, adjust the thermostat control knob to “4” and give your refrigerator time to cool down completely before adding food; a full 24 hours is recommended.</p> <p>After it is fully cooled, test it and adjust towards “1” to make less cool or towards “7” to cool more to best suit your needs. However, the setting of “4” should be appropriate for home or office refrigerator use.</p> <p>NOTE: Turning the control knob to the “OFF” position will stop the cooling cycle.</p>
--	--

DEFROSTING

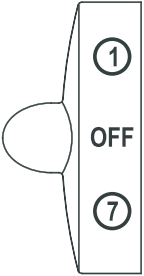
<p style="text-align: center;">Temp Control</p> <p>Thermostat control dial</p>  <p>The diagram shows a thermostat control dial with three positions: 1, OFF, and 7. The dial is a semi-circle with a knob on the left side. The positions are inside circles on the right side of the dial.</p>	<p>Refrigerator compartment: Defrosting process is automatic; melted frost flows into drip tray and automatically evaporates.</p> <p>Freezer compartment: Defrosting for the freezer must be performed manually.</p> <ol style="list-style-type: none">1. Turn the thermostat knob to the “OFF” position and leave the freezer door open.2. Remove all food and ice cube tray or transfer to refrigerator compartment.3. Place towel under compact refrigerator or move refrigerator outdoors where no water damage can occur.4. Clean and wipe out the melted frost with a cloth. <p>NOTE: To avoid damaging the freezer compartment wall, do not use any sharp objects to remove the frost or to separate the frozen food.</p>
--	--

OPERATION (CONTINUED)

REPLACING THE LIGHT BULB

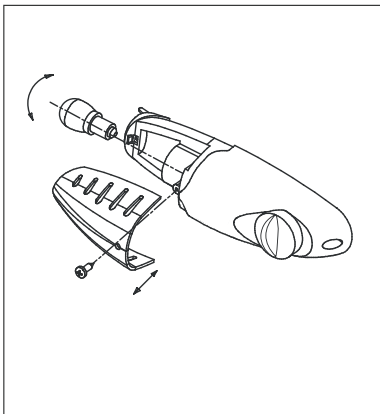

1. Unplug refrigerator or disconnect refrigerator from power supply before you remove the light bulb.
2. Unscrew the middle parts of the thermostat holder assembly, marked by the arrows in the diagram.
3. Pull the light bulb cover (thermostat holder assembly) outward to remove it.
4. Unscrew the light bulb.
5. Replace with a 15-watt 115V appliance bulb only. (Not all bulbs will fit your refrigerator. Be sure to replace the bulb with the same screw Type E-12 and shape. The T6 can be used.)
6. Plug in refrigerator or reconnect refrigerator to power supply.

OPERATION (CONTINUED)

Changing the door from the right side to the left.

The side at which the door opens can be changed from the right side (as supplied) to the left side, if the installation site requires.

Tools you will need:

- 8mm socket driver



- cross-shaped screwdriver



- Putty knife or thin-blade screwdriver



- 7mm wrench



Caution :

To avoid to injury yourself and/or property, we recommend someone assist you during the door reversal process.

.Ensure the Appliance is unplugged and empty.

.Following steps are generally recommended.

1. Stand the refrigerator, open the upper door and remove the things in the door and close it.
2. open the screw hole cove and the upper hinge cover which is at the top right corner of the refrigerator.

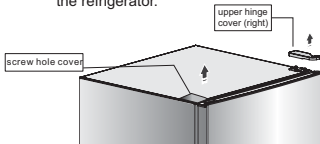

3. Unscrew the special flange self-tapping screws which are used for fixing the right upper hinge part by a 8mm socket driver or a spanner (please support the upper door with your hand when doing it).

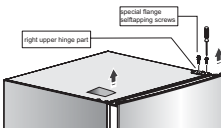

4. Remove the right upper hinge part and screw hole cover, place them on the smooth surface.

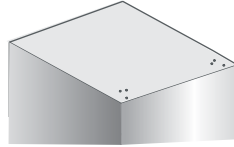

5. Remove upper door and place it on smooth surface with panel upwards.

6. Loose screws used to fix middle hinge and remove middle hinge. Then turn middle hinge by 180. Take washer on axis and put it on another end. Place it well for use.



7. Remove lower door and place panel upwards on smooth surface.

8. Change screw hole covers on middle cover plate from left to right (as shown in figure below).

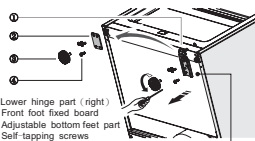
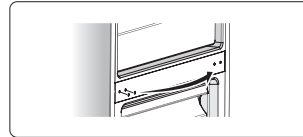

9. Use the 8mm socket driver to remove lower hinge part and front foot fixed board. Then screw out lower and adjustable bottom feet, change it to the near hole site, and then screw up and mount washer.

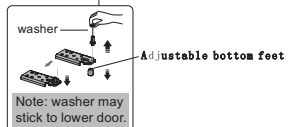

Note: Before this step, you should lay the refrigerator on it's back in order to gain access to the base, you should rest it on soft foam packaging or similar material to avoid damaging the cooling pipes at the rear of the refrigerator.

OPERATION (CONTINUED)

10. Change lower hinge part to left and front foot fixed board to right and fix them with screws. Then install adjustable bottom feet parts.

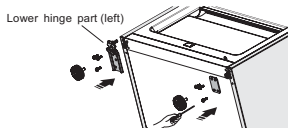

11. Stand the refrigerator then move lower door and adjust its position to align lower hole(left) site and lower hinge axis. Then adjust middle hinge and align the middle hinge axis to the higher (left) hole site. Then install the middle hinge.



Note: washer may stick to lower door.

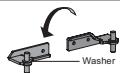

12. Move upper door to appropriate position, adjust upper hinge parts and upper door, and then fix upper hinge parts by screws. (Please hold upper door by hand when installing)

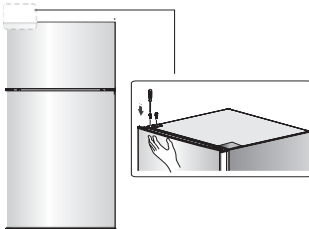

13. Replace and Install the right upper hinge cover on the left corner, Replace the screw hole cover on the right corner.

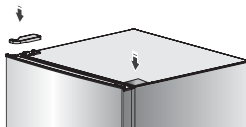

14. Stand and level the appliance.

NOTE:
Before the appliance is powered, We recommend that you should wait for about 2 hours.

TROUBLE SHOOTING GUIDE

The refrigerator will not operate

- The power supply cord is unplugged.
- The thermostat knob is set to the “OFF” position.
- A household fuse or circuit breaker has tripped.

The light does not work

- The power supply cord is unplugged.
- A household fuse or circuit breaker has tripped.
- The light bulb is loose in the socket.
- The light bulb has burned out.

Food in the refrigerator compartment is freezing

- The thermostat knob is set too cold.
- The position of food stored touches the refrigerator back wall.

Food in the refrigerator compartment is not cold

- The door is opened too often or not closed properly.
- A large amount of food has just been added to the refrigerator or freezer compartment.
- The position of thermostat knob is adjusted too low.

The refrigerator seems to make unusual noise

- The refrigerator is not leveled on the floor.
- The body of the refrigerator touches a wall.
- The drip tray is not placed properly.

There is interior moisture build-up

- The door is opened too often or not closed properly.
- The room is humid.
- The food is not packaged correctly.

The door will not close completely

- Food packages are keeping the door from closing properly.
- The shelves are out of position.
- The gaskets are dirty.
- The refrigerator is not level.

TECHNICAL SPECIFICATION

Unit Dimension (WxDxH)	18.7 inX21.5 inX33.7 in 47.5cmX54.6 cmX85.6cm
Power Supply	AC115V~60Hz 60W
Current	0.8A
Power consumption per year	322 kw.h
Net Weight	60 lbs. 27 Kg
Gross Weight	69 lbs. 31 Kg

Warranty for Hisense Compact Double Door Refrigerator

ONE-YEAR LIMITED MANUFACTURER'S SERVICE WARRANTY

This Warranty, provided by Hisense U.S.A. Corporation (hereinafter "Hisense") covers the Compact Refrigeration product (hereinafter "Product") in Canada, the United States of America, Puerto Rico, Guam and the U.S. Virgin Islands only, excluding any third party provided accessories and/or add-on's purchased separately; This warranty shall apply solely when this Product is purchased, stored, transported, handled, operated and maintained according to the Hisense provided instructions attached to or furnished with the Product. Hisense will, in its sole determination, repair or refund units deemed defective solely for materials or workmanship, at Hisense's discretion, for a limited warranty period of:

One (1) year for Parts and Labor on Product from the date of purchase (requires purchase receipt) for the original buyer only

Commercial and/or Rental use of this Product is not covered under this warranty.

WHAT IS NOT COVERED:

1. Any non-Hisense parts, including any third party provided accessories and/or add-on's;
2. Service to correct the installation of the Product, instruction on how to use the Product, replacement of home fuses or resetting circuit breakers, replacing or correcting home wiring.
3. Service related to use for other than normal, single family household use.
4. Damages of any kind resulting from accidents, alterations, misuse, abuse, fire, floods, acts of God, improper installation, installation not in accordance with electrical or plumbing codes, or use of products/accessories not approved by Hisense in writing.
5. Service outside of the United States, Canada, the Virgin Islands, Guam and Puerto Rico.
6. Service or support for units resulting from unauthorized modifications made to the Product.
7. Food or drink loss due to any sealed cooling system failures. Service calls to repair or replace light bulbs, air filters, water filters, other consumables, knobs, handles, or other cosmetic parts.
8. Damages caused by services performed by owner, service companies not authorized by Hisense in writing, the use of parts other than genuine Hisense parts, or parts obtained from entities other than Hisense authorized service companies.

DISCLAIMER OF IMPLIED WARRANTIES: LIMITATION OF REMEDIES

Exclusions and Limitations:

This Warranty covers manufacturing defects in materials and workmanship encountered in the normal, noncommercial use of the Product, and does not cover consumer instruction, delivery, installation, set-up, adjustments, cosmetic damage or damage due to acts of nature, accident, misuse, abuse, negligence, commercial use or modification of or to any part of the Product. This Warranty applies to the original consumer only and does not cover Products sold to consumers in used, "AS IS" or "WITH ALL PROBLEMS" condition, or consumables (e.g., fuses, batteries, bulbs etc.);

This Warranty is invalid if the factory-applied serial number has been altered or removed from the Product. Damage occurring to any Product returned for service that is caused by environmental hazards, improper or insecure packaging or shipping by the original consumer purchaser is excluded from coverage under this Warranty. This Warranty is valid only in Canada, the United States, the U.S. Virgin Islands, Guam, and Puerto Rico, and only applies to Products purchased and serviced in those regions. Warranty will be voided if attempts of repair are performed by the consumer or any third parties that are NOT authorized by Hisense in writing.

THERE ARE NO EXPRESS WARRANTIES OTHER THAN THOSE EXPRESSLY DESCRIBED ABOVE, AND NO WARRANTIES WHETHER EXPRESS OR IMPLIED, INCLUDING, BUT NOT LIMITED TO, ANY IMPLIED WARRANTIES OF MERCHANTABILITY OR FITNESS FOR A PARTICULAR PURPOSE, SHALL APPLY AFTER THE EXPRESS WARRANTY PERIOD STATED ABOVE, AND NO OTHER EXPRESS WARRANTY OR GUARANTY GIVEN BY ANY PERSON, FIRM OR ENTITY WITH RESPECT TO THE PRODUCT SHALL BE BINDING ON HISENSE. THIS WARRANTY IS THE SOLE

AND EXCLUSIVE WARRANTY WITH RESPECT TO THE PRODUCT AND HISENSE IS THE EXCLUSIVE WARRANTY PROVIDER FOR THE PRODUCT. REPAIR OR REFUND, AT HISENSE'S SOLE DISCRETION, IS THE EXCLUSIVE REMEDY OF THE CONSUMER. HISENSE SHALL NOT BE LIABLE FOR ANY INCIDENTAL OR CONSEQUENTIAL DAMAGES CAUSED BY THE USE, MISUSE OR INABILITY TO USE THE PRODUCT. NOTWITHSTANDING THE FOREGOING, CONSUMER'S RECOVERY AGAINST HISENSE SHALL NOT EXCEED THE PURCHASE PRICE OF THE PRODUCT SOLD BY HISENSE. THIS WARRANTY SHALL NOT EXTEND TO ANYONE OTHER THAN THE ORIGINAL CONSUMER WHO PURCHASED THE PRODUCT AND IS NOT TRANSFERABLE UNDER ANY CIRCUMSTANCES. PROOF OF PURCHASE SHALL BE REQUIRED FOR ALL WARRANTY CLAIMS.

If you need assistance, first see the "Troubleshooting" section of your instruction manual; After checking "Troubleshooting," additional help can be found by calling:
Hisense-USA: 1-877-465-3566(English & Spanish, Monday–Friday 9 a.m. to 6 p.m. EST)
Hisense Canada: 1-855-344-7367(English & French, Monday-Friday 8 a.m. to 9 p.m) or e-mail at (English & French) canadasupport@hisense.com

Keep this Warranty page and your sales receipts together for future reference. You must provide proof of purchase for warranty service.

Write down the following information about your appliance to better help you obtain assistance or service if you should ever need it. You will need to know your complete model and serial number. You can find this information on the model and serial number label located on the Product.

Store name: _____ Model number: _____
Address: _____ Serial number: _____
Phone number: _____ Purchase date: _____

The Hisense Call Center can provide assistance with:

- Features and specifications on our appliances
- Installation information
- Use and maintenance procedures
- Repair parts sales
- Referrals to service companies.

Designated service technicians are trained to fulfill the product warranty and provide after-warranty service, anywhere in the United States and US territories or Canada.

For further assistance

If you need further assistance, you can write with any questions or concerns to :

Hisense USA Corp.
PO Box 3289
Suwanee, GA 30024
USA

Hisense Canada Co., Ltd
Customer Service
405 Britannia Rd E., Suite 11
Mississauga, Ontario L4Z 3E6, Canada

Please include a daytime phone number in your correspondence.

PRODUCT REGISTRATION

To better safeguard your product, please log on to
www.hisense-usa.com/support/productReg.asp to register your product.



The Benefits of Product Registration:

Product Update

Proper registration will enable Hisense to contact you of safety notifications, updates, accessories, or other product changes.

Proof of Ownership

In the case of an insurance loss such as fire, flood, or theft, your registration will serve as your proof of purchase.

Better Service

If you have any questions about your new Hisense product, your registration will help us assist you.

Hisense

life reimagined