

## 8-Piece Bi-Metal Electrician's Hole Saw Kit

Juego de 8 sierras de copa bimetalicas de electricista

Jeu de 8 scies emporte-pièce bimétalliques pour électriciens

For Professionals... Since 1857®

31630

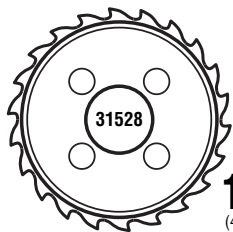

1-3/4"  
(44 mm)

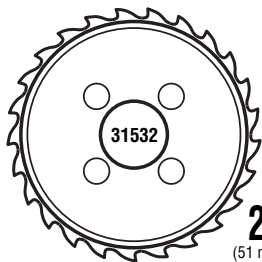

2"  
(51 mm)

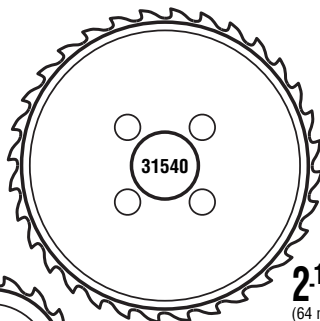

2-1/2"  
(64 mm)

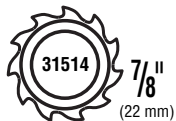

7/8"  
(22 mm)

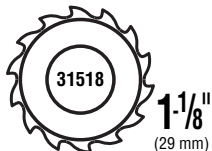

1-1/8"  
(29 mm)

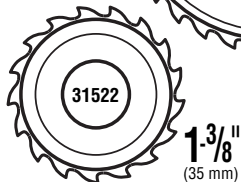

1-3/8"  
(35 mm)



### ⚠ WARNINGS:

- Always ensure that you and persons in the vicinity wear approved eye protection.
- Never use on or near live electrical circuits.

**Note:** Read and follow safety instructions in power tool owner's manual.

**Note:** Set pilot drill point 1/8" beyond tooth points.

### ⚠ ADVERTENCIAS:

- Asegúrese siempre de que usted y la personas que estén en la vecindad usen protección aprobada.
- No utilice nunca la herramienta en circuitos eléctricos con corriente ni cerca de ellos.

**Nota:** Lea y siga las instrucciones de seguridad que aparecen en el manual del usuario de las herramientas mecánicas.

**Nota:** Ajuste la punta de la broca piloto 1/8 pulgada más allá de las puntas de los dientes.

### ⚠ AVERTISSEMENTS :

- Assurez-vous toujours que les personnes se trouvant dans le voisinage ainsi que vous-même portent des équipements agréés de protection des yeux.
- N'utilisez jamais sur des circuits électriques sous tension ou à proximité de tels circuits.

**Remarque:** Lire et suivre les consignes de sécurité contenues dans le mode d'emploi de l'outil électrique.

**Remarque:** Réglez la pointe de la mèche pilote à 1/8 po au-delà des pointes des dents.

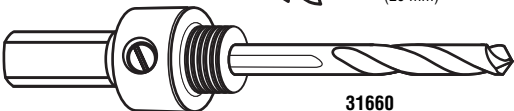

31660

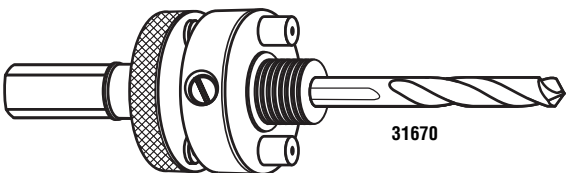

31670

Suggested Speed (RPM) for Hole Saw Size Ranges	Mild Steel Acero Suave Acier Doux	Wood/Plastic/Aluminum Madera/Plástico/Aluminio Bois/Plastique/Aluminium	Brass Latón Laiton	Stainless Steel Acero Inoxidable Acier Inoxydable	Cast Iron Hierro Fundido Fonte
5/8" - 1" (16 - 25 mm)	450	680	600	230	300
1-1/16" - 1-5/8" (27 - 41 mm)	230	390	345	130	175
1-3/4" - 2-1/8" (44 - 54 mm)	180	270	240	90	120
2-1/4" - 3" (57 - 76 mm)	130	200	175	65	90



**KLEIN TOOLS, INC**

Chicago, IL USA

© 2012

[www.kleintools.com](http://www.kleintools.com)

1-800-KLEIN76



133296T  
Rev 05/12 B