

If you have questions or comments, contact us.  
 Pour toute question ou tout commentaire, nous contacter.  
 Si tiene dudas o comentarios, contáctenos.

1-800-4-DEWALT • www.dewalt.com

INSTRUCTIVO DE OPERACIÓN, CENTROS DE SERVICIO Y PÓLIZA DE GARANTÍA. ADVERTENCIA: LEÁSE ESTE INSTRUCTIVO ANTES DE USAR EL PRODUCTO.

INSTRUCTION MANUAL  
 GUIDE D'UTILISATION  
 MANUAL DE INSTRUCCIONES

# DEWALT®

D25113, D25213, D25313, D25323, D25324 Heavy-Duty 1" (26 mm) SDS Plus® Rotary Hammers  
 D25330 Heavy-Duty SDS Plus® Chipping Hammer  
 Marteaux rotatifs industriels SDS Plus®, 26 mm (1 po), D25113, D25213, D25313, D25223, D25323, D25324  
 Marteau burineur industriel SDS Plus® D25330  
 Rotomartillos SDS Plus® de 26 mm (1") para trabajos pesados D25113, D25213, D25313, D25223, D25313, D25323, D25324  
 Martillo de soldador SDS Plus® para trabajos pesados D25113, D25213, D25313, D25223, D25313, D25323, D25324

DEWALT Industrial Tool Co., 701 Joppa Road, Baltimore, MD 21286  
 (JUL09) Part No. N018731 Copyright © 2006, 2009 DEWALT  
 D25113, D25213, D25313, D25223, D25323, D25324, D25330

The following are trademarks for one or more DEWALT power tools: the yellow and black color scheme; the "D" shaped air intake grill; the array of pyramids on the handgrip; the kit box configuration; and the array of lozenge-shaped humps on the surface of the tool.

### Definitions: Safety Guidelines

The definitions below describe the level of severity for each signal word. Please read the manual and pay attention to these symbols.

- ▲ **DANGER:** Indicates an imminently hazardous situation which, if not avoided, will result in death or serious injury.
  - ▲ **WARNING:** Indicates a potentially hazardous situation which, if not avoided, could result in death or serious injury.
  - ▲ **CAUTION:** Indicates a potentially hazardous situation which, if not avoided, may result in minor or moderate injury.
- CAUTION:** Used without the safety alert symbol indicates a potentially hazardous situation which, if not avoided, may result in property damage.

IF YOU HAVE ANY QUESTIONS OR COMMENTS ABOUT THIS OR ANY DEWALT TOOL, CALL US TOLL FREE AT: 1-800-4-DEWALT (1-800-433-9258)

 **WARNING:** To reduce the risk of injury, read the instruction manual.

### General Power Tool Safety Warnings

 **WARNING!** Read all safety warnings and all instructions. Failure to follow the warnings and instructions may result in electric shock, fire and/or serious injury.

### SAVE ALL WARNINGS AND INSTRUCTIONS FOR FUTURE REFERENCE

The term "power tool" in the warnings refers to your mains-operated (corded) power tool or battery-operated (cordless) power tool.

#### 1) WORK AREA SAFETY

- a) **Keep work area clean and well lit.** Cluttered or dark areas invite accidents.
- b) **Do not operate power tools in explosive atmospheres, such as in the presence of flammable liquids, gases or dust.** Power tools create sparks which may ignite the dust or fumes.
- c) **Keep children and bystanders away while operating a power tool.** Distractions can cause you to lose control.

#### 2) ELECTRICAL SAFETY

- a) **Power tool plugs must match the outlet. Never modify the plug in any way. Do not use any adapter plugs with earthed (grounded) power tools.** Unmodified plugs and matching outlets will reduce risk of electric shock.
- b) **Avoid body contact with earthed or grounded surfaces such as pipes, radiators, ranges and refrigerators.** There is an increased risk of electric shock if your body is earthed or grounded.
- c) **Do not expose power tools to rain or wet conditions.** Water entering a power tool will increase the risk of electric shock.
- d) **Do not abuse the cord. Never use the cord for carrying, pulling or unplugging the power tool. Keep cord away from heat, oil, sharp edges or moving parts.** Damaged or entangled cords increase the risk of electric shock.
- e) **When operating a power tool outdoors, use an extension cord suitable for outdoor use.** Use of a cord suitable for outdoor use reduces the risk of electric shock.
- f) **If operating a power tool in a damp location is unavoidable, use a ground fault circuit interrupter (GFCI) protected supply.** Use of a GFCI reduces the risk of electric shock.

#### 3) PERSONAL SAFETY

- a) **Stay alert, watch what you are doing and use common sense when operating a power tool. Do not use a power tool while you are tired or under the influence of drugs, alcohol or medication.** A moment of inattention while operating power tools may result in serious personal injury.
- b) **Use personal protective equipment. Always wear eye protection.** Protective equipment such as dust mask, non-skid safety shoes, hard hat, or hearing protection used for appropriate conditions will reduce personal injuries.
- c) **Prevent unintentional starting. Ensure the switch is in the off position before connecting to power source and/or battery pack, picking up or carrying the tool.** Carrying power tools with your finger on the switch or energising power tools that have the switch on invites accidents.
- d) **Remove any adjusting key or wrench before turning the power tool on.** A wrench or a key left attached to a rotating part of the power tool may result in personal injury.
- e) **Do not overreach. Keep proper footing and balance at all times.** This enables better control of the power tool in unexpected situations.
- f) **Dress properly. Do not wear loose clothing or jewellery. Keep your hair, clothing and gloves away from moving parts.** Loose clothes, jewellery or long hair can be caught in moving parts.
- g) **If devices are provided for the connection of dust extraction and collection facilities, ensure these are connected and properly used.** Use of dust collection can reduce dust-related hazards.

#### 4) POWER TOOL USE AND CARE

- a) **Do not force the power tool. Use the correct power tool for your application.** The correct power tool will do the job better and safer at the rate for which it was designed.
- b) **Do not use the power tool if the switch does not turn it on and off.** Any power tool that cannot be controlled with the switch is dangerous and must be repaired.
- c) **Disconnect the plug from the power source and/or the battery pack from the power tool before making any adjustments, changing accessories, or storing power tools.** Such preventive safety measures reduce the risk of starting the power tool accidentally.
- d) **Store idle power tools out of the reach of children and do not allow persons unfamiliar with the power tool or these instructions to operate the power tool.** Power tools are dangerous in the hands of untrained users.
- e) **Maintain power tools. Check for misalignment or binding of moving parts, breakage of parts and any other condition that may affect the power tool's operation. If damaged, have the power tool repaired before use.** Many accidents are caused by poorly maintained power tools.
- f) **Keep cutting tools sharp and clean.** Properly maintained cutting tools with sharp cutting edges are less likely to bind and are easier to control.
- g) **Use the power tool, accessories and tool bits etc., in accordance with these instructions taking into account the working conditions and the work to be performed.** Use of the power tool for operations different from those intended could result in a hazardous situation.

#### 5) SERVICE

- a) **Have your power tool serviced by a qualified repair person using only identical replacement parts.** This will ensure that the safety of the power tool is maintained.

### Additional Safety Instructions for Rotary Hammers

- **Wear ear protectors.** Exposure to noise can cause hearing loss.
- **Use auxiliary handles supplied with the tool.** Loss of control can cause personal injury.
- **Hold power tools by insulated gripping surfaces when performing an operation where the cutting tool may contact hidden wiring or its own cord.** Contact with a "live" wire will make exposed metal parts of the tool "live" and shock the operator.
- **Use clamps or other practical way to secure and support the workpiece to a stable platform.** Holding the work by hand or against your body is unstable and may lead to loss of control.
- **Wear safety goggles or other eye protection.** Hammering operations cause chips to fly. Flying particles can cause permanent eye damage. Wear a dust mask or respirator for applications that generate dust. Ear protection may be required for most applications.
- **Keep a firm grip on the tool at all times. Do not attempt to operate this tool without holding it with both hands.** It is recommended that the side handle be used at all times. Operating this tool with one hand will result in loss of control. Breaking through or encountering hard materials such as re-bar may be hazardous as well. Tighten the side handle securely before use.
- **Do not use this tool to mix or pump easily combustible or explosive fluids (benzine, alcohol, etc.).**
- **Do not mix or stir inflammable liquids labelled accordingly.**
- **Do not operate this tool for long periods of time.** Vibration caused by hammer action may be harmful to your hands and arms. Use gloves to provide extra cushion and limit exposure by taking frequent rest periods.
- **Do not recondition bits yourself.** Chisel reconditioning should be done by an authorized specialist. Improperly reconditioned chisels could cause injury.
- **Wear gloves when operating tool or changing bits.** Accessible metal parts on the tool and bits may get extremely hot during operation. Small bits of broken material may damage bare hands.
- **Never lay the tool down until the bit has come to a complete stop.** Moving bits could cause injury.
- **Do not strike jammed bits with a hammer to dislodge them.** Fragments of metal or material chips could dislodge and cause injury.
- **Slightly worn chisels can be resharpened by grinding.**
- **Keep the power cord away from the rotating bit. Do not wrap the cord around any part of your body.** An electric cord wrapped around a spinning bit may cause personal injury and loss of control.
- **Air vents often cover moving parts and should be avoided.** Loose clothes, jewellery or long hair can be caught in moving parts.
- **An extension cord must have adequate wire size (AWG or American Wire Gauge) for safety.** The smaller the gauge number of the wire, the greater the capacity of the cable, that is 16 gauge has more capacity than 18 gauge. An undersized cord will cause a drop in line voltage resulting in loss of power and overheating. When using more than one extension to make up the total length, be sure each individual extension contains at least the minimum wire size. The following table shows the correct size to use depending on cord length and nameplate ampere rating. If in doubt, use the next heavier gauge. The smaller the gauge number, the heavier the cord.

		Minimum Gauge for Cord Sets				
		Volts	Total Length of Cord in Feet (meters)			
Ampere Rating		120V	25 (7.6)	50 (15.2)	100 (30.5)	150 (45.7)
		240V	50 (15.2)	100 (30.5)	200 (61.0)	300 (91.4)
		AWG				
More Than	Not More Than					
0	6		18	16	16	14
6	10		18	16	14	12
10	12		16	16	14	12
12	16		14	12	Not Recommended	

**NOTE:** Do not overheat the bit (discoloration) while grinding a new edge. Badly worn chisels require reforging. Do not reharden and temper the chisel.

▲ **WARNING: ALWAYS** use safety glasses. Everyday eyeglasses are NOT safety glasses. Also use face or dust mask if cutting operation is dusty. ALWAYS WEAR CERTIFIED SAFETY EQUIPMENT:

- ANSI Z87.1 eye protection (CAN/CSA Z94.3),
- ANSI S12.6 (S3.19) hearing protection,
- NIOSH/OSHA/MSHA respiratory protection.

▲ **WARNING:** Some dust created by power sanding, sawing, grinding, drilling, and other construction activities contains chemicals known to cause cancer, birth defects or other reproductive harm. Some examples of these chemicals are:

- lead from lead-based paints,
- crystalline silica from bricks and cement and other masonry products, and
- arsenic and chromium from chemically-treated lumber.

Your risk from these exposures varies, depending on how often you do this type of work. To reduce your exposure to these chemicals: work in a well ventilated area, and work with approved safety equipment, such as those dust masks that are specially designed to filter out microscopic particles.

• **Avoid prolonged contact with dust from power sanding, sawing, grinding, drilling, and other construction activities. Wear protective clothing and wash exposed areas with soap and water.** Allowing dust to get into your mouth, eyes, or lay on the skin may promote absorption of harmful chemicals.

▲ **WARNING:** Use of this tool can generate and/or disburse dust, which may cause serious and permanent respiratory or other injury. Always use NIOSH/OSHA approved respiratory protection appropriate for the dust exposure. Direct particles away from face and body.

▲ **WARNING: Always use eye protection.** All users and bystanders must wear eye protection that conforms to ANSI Z87.1.

▲ **WARNING: Always wear proper personal hearing protection that conforms to ANSI S12.6 (S3.19) during use.** Under some conditions and duration of use, noise from this product may contribute to hearing loss.

• The label on your tool may include the following symbols. The symbols and their definitions are as follows:

V..... volts	A..... amperes
Hz..... hertz	W..... watts
min ..... minutes	~ ..... alternating current
==== ..... direct current	⎓ ..... alternating or direct current
Ⓜ ..... Class I Construction (grounded)	n <sub>0</sub> ..... no load speed
Ⓜ ..... Class II Construction (double insulated)	Ⓧ ..... earthing terminal
.../min ..... per minute	▲ ..... safety alert symbol
	BPM ..... beats per minute
	RPM ..... revolutions per minute

### Motor

Your DEWALT tool is powered by a DEWALT-built motor. Be sure your power supply agrees with the nameplate markings. Voltage decrease of more than 10% will cause loss of power and overheating. All DEWALT tools are factory tested.

### COMPONENTS (Fig. 1)

▲ **WARNING:** Never modify the power tool or any part of it. Damage or personal injury could result.

- |  |   |
|--|---|
| A. Variable speed switch   | F. Chuck                                |
| B. Active vibration handle (D25223, D25323, D25324 only)                   | G. Dust cover                           |
| C. Forward/reverse slider (D25113, D25213, D25313, D25223, D25323, D25324) | H. Depth adjustment rod                 |
| D. Mode selector (D25113, D25213, D25313, D25223, D25323, D25324)          | I. Side handle                          |
| E. Mode selector button (D25113, D25213, D25313, D25223, D25323, D25324)   | J. Depth stop button                    |
|  | K. Locking collar (D25324 only)         |
|  | L. Lock-on button (D25113, D25330 only) |
|  | M. Chisel rotation (D25330 only)        |

## INTENDED USE

These heavy-duty rotary hammers have been designed for professional drilling and hammerdrilling, screwdriving and light chipping at various work sites (i.e., construction sites). **DO NOT** use under wet conditions or in presence of flammable liquids or gases.

These heavy-duty rotary hammers are professional power tools. **DO NOT** let children come into contact with the tool. Supervision is required when inexperienced operators use this tool.

## Active Vibration Control (Fig. 1)

### D25223, D25323 AND D25324 ONLY

The active vibration control reduces rebound vibration from the hammer mechanism. Reducing hand and arm vibration allows for more comfortable use for longer periods of time and extends the life of the unit.

For best vibration control, hold the tool with one hand on the main handle (B) and the other hand on the side handle (I). Apply just enough pressure so the hammer is approximately mid-stroke.

The hammer only needs enough pressure to engage the active vibration control. Applying too much pressure will not make the tool drill or chip faster and active vibration control will not engage.

## Torque Limiting Clutch

All rotary hammer drills are equipped with a torque limiting clutch that reduces the maximum torque reaction transmitted to the operator in case of jamming of a drill bit. This feature also prevents the gearing and electric motor from stalling. The torque limiting clutch has been factory-set and cannot be adjusted.

## Side Handle (Fig. 2)

**▲WARNING:** To reduce the risk of personal injury, **ALWAYS** operate the tool with the side handle properly installed and securely tightened. Failure to do so may result in the side handle slipping during tool operation and subsequent loss of control. Hold tool with both hands to maximize control.

A side handle comes assembled with this rotary hammer. The side handle (I) can be fitted to suit both right-hand and left-hand users.

## TO ADJUST THE SIDE HANDLE

1. Loosen the side handle (I) by turning it counterclockwise.
2. Rotate the side handle to the desired position.
3. Tighten the side handle by turning it clockwise.

## TO CHANGE SIDES

For right-hand users: slide the side handle clamp over the chuck, handle at the left.

For left-hand users: slide the side handle clamp over the chuck, handle at the right.

## Trigger Switch (Fig. 1)

To start the rotary hammer, depress the trigger switch (A). To stop rotary hammer, release the switch.

**NOTE:** Use lower speeds for starting holes without a centerpunch, drilling in metal, plastics or ceramics, or driving screws. Higher speeds are better for drilling in masonry for maximum efficiency.

## VARIABLE SPEED

The variable speed trigger switch (A) permits speed control. The farther the trigger switch is depressed, the higher the speed of the drill.

### D25113, D25213, D25313, D25223, D25323, D25324

To lock the tool in Off position move the forward/reverse slider (C) to the central position.

## Lock-on Button (Fig. 1)

### D25113, D25330

**▲WARNING:** Be sure to release the locking mechanism before disconnecting the plug from the power supply. Failure to do so will cause the hammerdrill to start immediately the next time it is plugged in. Damage or personal injury could result.

The lock-on button (L) is for use only when the rotary hammer is stationary, mounted in a drill press stand or for chipping applications.

Before using the tool each time, be sure that the lock-on button release mechanism is working freely.

### D25113 ONLY

To lock the trigger switch in the on position for continuous operation, depress and hold the trigger switch and slide the lock-off button (L) forward. The tool will continue to run.

To turn the tool off from a locked on condition, squeeze the trigger once then release it.

### D25330 ONLY

To lock the trigger switch in the On position for continuous operation, depress the trigger switch and push the lock-on button (L) in. The tool will continue to run.

To turn the tool Off from a locked on condition, squeeze the trigger once then release it.

## Forward/reverse Slider (Fig. 1)

### D25113, D25213, D25313, D25223, D25323, D25324

**▲WARNING:** Always wait until the motor has come to a complete standstill before changing the direction of rotation.

**▲CAUTION:** When reversing to clear jammed bits, be ready for strong reactive torque.

The forward/reverse slider (C) is used to reverse the rotary hammer for backing out fasteners or jammed bits mode.

1. Push the forward/reverse slider (C) to the left (viewed when holding drill in operating position) for forward (right-hand) rotation. See arrows on tool.
2. Push the forward/reverse slider (C) to the right for reverse (left-hand) rotation.

## Mode Selector (Fig. 3)

### D25113, D25213, D25313, D25223, D25323, D25324

**NOTICE:** Tool must come to a complete stop before activating the mode selector button or damage to the tool may result.

### DRILL-ONLY MODE

To use drill-only mode, press mode selector button (E) and turn the mode selector (D) so the yellow arrow points to the corresponding symbol as shown. Use drill-only mode for wood, metal, and plastics.

### HAMMERDRILL MODE

To use hammerdrill mode, press the mode selector button (E) and turn the mode selector (D) so the yellow arrow points to the corresponding symbol as shown. Use this mode for masonry drilling.

### HAMMER-ONLY MODE

For light chiseling, press the mode selector button (E) and turn the mode selector (D) so the yellow arrow points to the corresponding symbol as shown.

**NOTE:** The yellow arrow on the mode selector **MUST** be aligned with the one of the symbols at all times. There are no operable positions between the positions.

### CHISEL ROTATION

### D25313, D25323, D25324

To manually rotate the chisel, depress the button (E) and turn the mode selector (D) so the yellow arrow points to the corresponding symbol as shown.

## SDS Plus® Chuck (Fig. 1)

**▲WARNING:** To reduce the risk of serious personal injury, turn tool off and disconnect tool from power source before making any adjustments or removing/installing attachments or accessories.

**▲WARNING:** Burn Hazard. **ALWAYS** wear gloves when changing bits. Accessible metal parts on the tool and bits may get extremely hot during operation. Small bits of broken material may damage bare hands.

**▲WARNING:** Do not attempt to tighten or loosen drill bits (or any other accessory) by gripping the front part of the chuck and turning the tool on. Damage to the chuck and personal injury may occur.

**To insert bit,** insert shank of bit about 3/4" (19 mm), no further than 7/8" (22 mm) into chuck. Push and rotate bit until it locks in place. The bit will be securely held.

**To release bit,** pull the chuck sleeve (F) back and remove the bit.

## OPERATION

**▲WARNING:** To reduce the risk of serious personal injury, turn tool off and disconnect tool from power source before making any adjustments or removing/installing attachments or accessories.

**▲WARNING:** To reduce the risk of personal injury, **ALWAYS** ensure workpiece is anchored or clamped firmly. If drilling thin material, use a wood "back-up" block to prevent damage to the material.

**▲To reduce the risk of personal injury, ALWAYS operate the tool with the side handle properly installed and securely tightened. Failure to do so may result in the side handle slipping during tool operation and subsequent loss of control. Hold tool with both hands to maximize control.**

## Proper Hand Position (Fig. 3)

**▲WARNING:** To reduce the risk of serious personal injury, **ALWAYS** use proper hand position as shown.

**▲WARNING:** To reduce the risk of serious personal injury, **ALWAYS** hold securely in anticipation of a sudden reaction.

Proper hand position requires one hand on the side handle (I), with the other hand on the main handle (B).

## Overload Clutch

If the drill bit becomes jammed or caught, the drive to the drill spindle is interrupted by the overload clutch. Because of the forces that occur as a result, always hold the machine securely with both hands and take a firm stance.

## Drilling Tools

The machine is intended for hammerdrilling in concrete, brick and stone. It is also suitable for drilling without impact in wood, metal, ceramic and plastic.

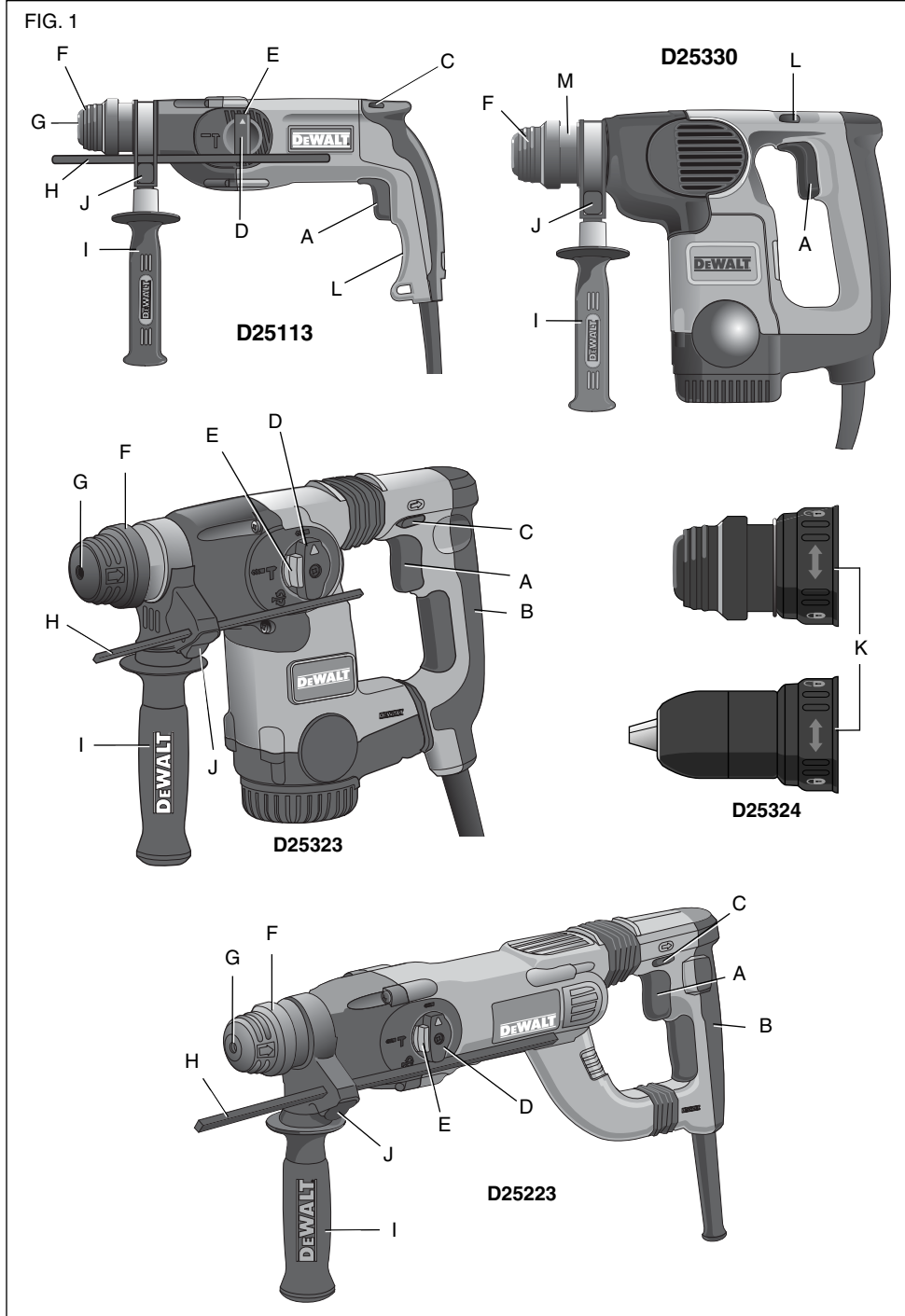

FIG. 2

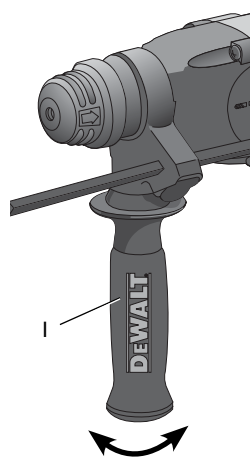

FIG. 3

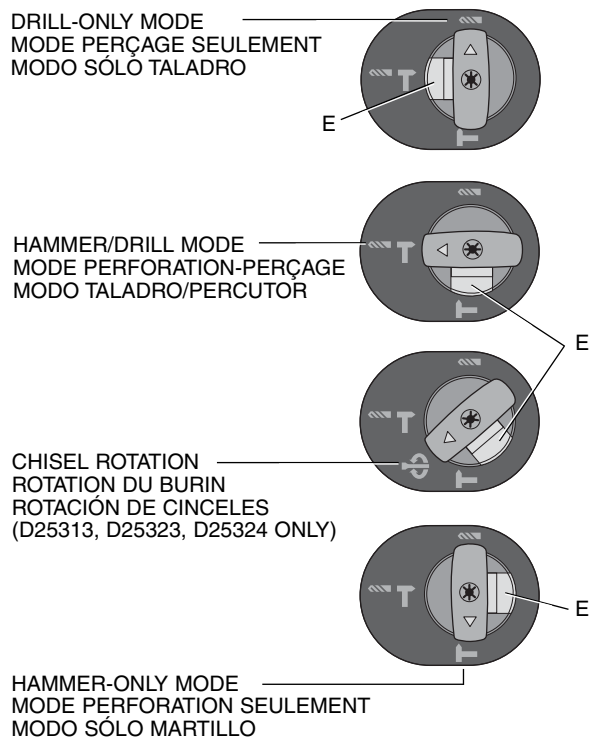

FIG. 3

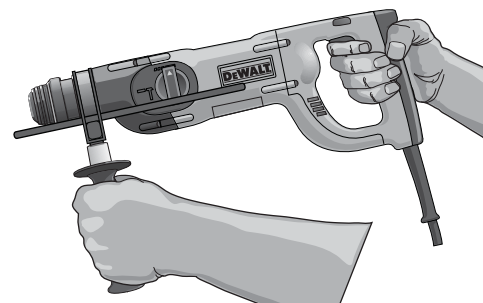
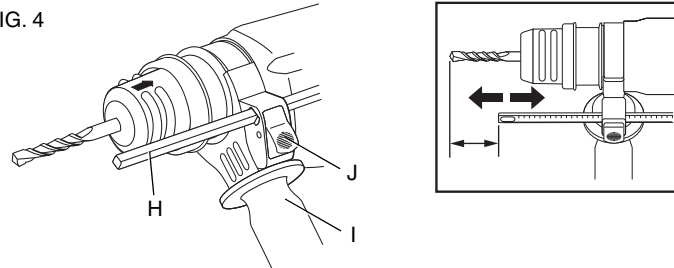

FIG. 4



## Chipping Tools

The machine is intended for chipping in concrete, brick and stone.

## Removable SDS Plus® Chuck and Three Jaw Keyless Chuck (Fig. 1)

### D25324

The D25324 is equipped with a removable quick change SDS Plus® chuck as well as a removable three jaw keyless chuck. The hammer mechanism does not function when the three jaw keyless chuck is used.

Both the SDS Plus® and three jaw keyless chuck can be easily removed by turning the locking collar (K) into the unlocked position to release the chuck.

The SDS Plus® and three jaw keyless chuck can be easily attached by inserting the chuck into the spindle of the tool and turning the collar to the locked position. The chuck will click when properly installed.

## Drilling

**▲WARNING:** To reduce the risk of serious personal injury, turn tool off and disconnect tool from power source before making any adjustments or removing/installing attachments or accessories.

**▲WARNING:** To reduce the risk of personal injury, **ALWAYS** ensure workpiece is anchored or clamped firmly. If drilling thin material, use a wood "back-up" block to prevent damage to the material.

Press mode selector button (E) and turn the mode selector (D) to the drill bit symbol for drilling, to the hammer symbol for hammering or to the hammerdrill symbol for hammerdrilling.

## DRILLING OPERATION

1. For WOOD, use twist bits, spade bits, power auger bits or hole saws. For METAL, use high-speed steel twist drill bits or hole saws. Use a cutting lubricant when drilling metals. The exceptions are cast iron and brass which should be drilled dry. For MASONRY, use carbide-tipped bits or masonry bits. A smooth, even flow of dust indicates the proper drilling rate.
2. Always apply pressure in a straight line with the bit. Use enough pressure to keep the drill bit biting, but do not push hard enough to stall the motor or deflect the bit.
3. Hold tool firmly with both hands to control the twisting action of the drill.

**▲WARNING:** Drill may stall if overloaded causing a sudden twist. Always expect the stall. Grip the drill firmly with both hands to control the twisting action and avoid injury.









