



ENGLISH

ESPAÑOL

FRANÇAIS

OWNER'S MANUAL VACUUM CLEANER

Please read this manual carefully before operating your vacuum and retain it for future reference.

LcV900B

CONTENTS

LG VACUUM CLEANER WARRANTY

- 3 LG VACUUM CLEANER WARRANTY

IMPORTANT SAFETY INFORMATION

- 4-5 IMPORTANT SAFETY INFORMATION

PARTS AND FEATURES

- 6 PARTS AND FEATURES

ASSEMBLY

- 7 Unpacking the Vacuum Cleaner
- 7 Assembly Parts
- 8 The Vacuum Cleaner Assembly
- 8 Canister
- 8 Telescopic Wand
- 8 Hose
- 8 Power Nozzle
- 9 Accessory Storage
- 9 Cord Storage

OPERATION

- 10 Control Operation
- 10 Adjusting for Carpet Pile Height
- 11 Accessories
- 11 Accessory Use Chart
- 12 Installing Attachments
- 12 Tips and Tricks
- 12 Using the Bare Floor Nozzle
- 13 Stairways and Landings
- 13 Agitator Motor Overload Protection
- 13 Thermal Overload Protection

CARE & CLEANING

- 14 Storing the Vacuum Cleaner
- 14 Dust Tank and Dust Separator Component
- 15 Emptying the Dust Tank
- 15 Cleaning the Dust Tank
- 16 Cleaning the Foam Pre Filter
- 17 Cleaning the HEPA Filter
- 18 Agitator Maintenance
- 18 Replacing the Agitator Belt
- 19 Removing Clogs
- 20 Cleaning the Exterior of the Vacuum Cleaner

TROUBLESHOOTING

- 21-22 Troubleshooting

LG VACUUM CLEANER WARRANTY

LG Electronics Inc. will repair or replace your product, at LG's option, if it proves to be defective in material or workmanship under personal household use, during the warranty period set forth below, effective from the date of original consumer purchase of the product. This limited warranty is good only to the original purchaser of the product and effective only when used in U.S.A. and Canada.

WARRANTY PERIOD:	HOW SERVICE IS HANDLED:
Five Year From the date of the original purchase	Any part of the vacuum cleaner which fails due to a defect in materials or workmanship. During this full five-year warranty , LG will also provide, free of charge , all labor and shop service to replace the defective part. (Except-Suction motor 3 years warranty)

THIS WARRANTY IS IN LIEU OF ANY OTHER WARRANTIES, EXPRESS OR IMPLIED, INCLUDING WITHOUT LIMITATION, ANY WARRANTY OF MERCHANTABILITY OR FITNESS FOR A PARTICULAR PURPOSE. TO THE EXTENT ANY IMPLIED WARRANTY IS REQUIRED BY LAW, IT IS LIMITED IN DURATION TO THE EXPRESS WARRANTY PERIOD ABOVE. LG WILL NOT BE LIABLE FOR ANY CONSEQUENTIAL, INDIRECT, OR INCIDENTAL DAMAGES OF ANY KIND, INCLUDING LOST REVENUES OR PROFITS, IN CONNECTION WITH THE PRODUCT. SOME STATES DO NOT ALLOW LIMITATION ON HOW LONG AN IMPLIED WARRANTY LASTS OR THE EXCLUSION OF INCIDENTAL OR CONSEQUENTIAL DAMAGES, SO THE ABOVE LIMITATIONS OR EXCLUSIONS MAY NOT APPLY TO YOU.

This warranty covers only defects in material and workmanship.

LGE will NOT pay for:

1. Expendable items that can wear out, including, but not limited to, filters and belts.
2. A service technician to instruct the user in correct product assembly, operation or maintenance.
3. A service technician to clean or maintain this product.
4. Damage to or failure of this product if it is not assembled, operated or maintained according to all instructions supplied with this product.
5. Damage to or failure of this product resulting from accident, abuse, misuse or use for other than its intended purpose.
6. Damage to or failure of this product caused by the use of detergents, cleaners, chemicals or utensils other than those recommended in all instructions supplied with this product.
7. Damage to or failure of parts or systems resulting from unauthorized modifications made to this product.

This warranty is extended to the original purchaser for products purchased for home use within the U.S.A. In Alaska, the warranty excludes the cost of shipping or service calls to your home.

Some states do not allow the exclusion or limitation of incidental or consequential damages, so this exclusion or limitation may not apply to you. This warranty gives you specific legal rights, and you may also have other rights which vary from states to states. To know what your legal rights are, consult your local or state consumer affairs or your state's Attorney General.

CUSTOMER ASSISTANCE INFORMATION:

To Prove Warranty Coverage	Retain your Sales Receipt to prove date of purchase. A copy of your Sales Receipt must be submitted at the time warranty service is provided.
To Obtain Nearest Authorized Service Center or Sales Dealer, or to Obtain Product, Customer, or Service Assistance	Call 1-800-243-0000 (Phone answered 24 hours - 365 days a year) and choose the appropriate prompt from the menu; or visit our website at: http://us.lgservice.com . (In Canada- Call 1-888-542-2623, website http://ca.lgservice.com)

IMPORTANT SAFETY INFORMATION

READ ALL INSTRUCTIONS BEFORE USE

IMPORTANT SAFETY INSTRUCTIONS

Read and follow all instructions before using your vacuum cleaner to prevent the risk of fire, electric shock, personal injury, or damage when using the vacuum cleaner. This guide does not cover all possible conditions that may occur. Always contact your service agent or manufacturer about problems that you do not understand.



This is the safety alert symbol. This symbol alerts you to potential hazards that can kill or hurt you and others. All safety messages will follow the safety alert symbol and either the word "WARNING" or "CAUTION".



WARNING

Indicates a hazardous situation which, if not avoided, could result in death or serious injury.



CAUTION

Indicates a hazardous situation which, if not avoided, could result in minor or moderate injury.



WARNING

- **Disconnect electrical supply before servicing or cleaning the unit or when cleaner is not in use.**
Failure to do so could result in electrical shock or personal injury.
- **Do not use vacuum cleaner to pick up anything that is burning or smoking such as cigarettes, matches, or hot ashes.**
Failure to follow this instruction could result in death, fire or electrical shock.
- **Do not vacuum flammable or explosive substances such as gasoline, benzene, thinners, propane (liquids or gases).**
The fumes from these substances can create a fire hazard or explosion. Doing so could result in death or personal injury.
- **Do not handle plug or vacuum cleaner with wet hands.**
Failure to follow this instruction could result in death or electrical shock.
- **Do not unplug by pulling the cord.**
Failure to follow this instruction could result in product damage or electrical shock. To unplug, grasp the plug, not the cord.
- **Keep hair, loose clothing, fingers, and all parts of the body away from openings and moving parts.**
Failure to do so could result in electrical shock or personal injury.
- **Do not pull or carry by cord, use cord as a handle, close a door on cord, or pull cord around sharp edges or corners. Do not run vacuum cleaner over cord. Keep cord away from heated surfaces.**
Failure to follow this instruction could result in electrical shock or personal injury, fire, or product damage.
- **Do not use as a toy. Close attention is necessary when used by or near children.**
Personal injury or product damage could result.
- **Do not use with damaged cord or plug. If appliance is not working as it should, has been dropped, damaged, left outdoors, or dropped into water, return it to a service center.**
Personal injury or product damage could result. If the power cord or plug is damaged or faulty, contact LG Electronics Service Agent to avoid hazard.
- **Do not use vacuum cleaner if it has been under water.**
Personal injury or product damage could result. If the vacuum has water damage, contact LG Electronics Service Agent to avoid hazard.
- **Always turn off this appliance before connecting or disconnecting either hose or motorized nozzle.**
- **Do not leave appliance when plugged in. Unplug from outlet when not in use and before servicing.**
- **Hold plug when rewinding onto cord reel. Do not allow plug to whip when rewinding.**
- **Do not continue to vacuum if any parts appear missing or damaged.**
Personal injury or product damage could result. If parts are missing or damaged, contact LG Electronics Service Agent to avoid hazard.
- **Do not use an extension cord with this vacuum cleaner.**
Fire hazard or product damage could result.
- **Use proper voltage.**
Using improper voltage may result in damage to the motor and possible injury to the user. Proper voltage is listed on the bottom of vacuum cleaner.
- **Turn off all controls before unplugging.**
Failure to do so could result in electrical shock or personal injury.
- **Do not modify the plug in any way.**
Failure to follow this instruction could result in electrical shock, product damage, personal injury or death. If plug does not fit, contact a qualified electrician to install the proper outlet.
- **Repairs to electrical appliances may only be performed by qualified service technicians.**
Improper repairs may lead to serious hazards for the user.
- **Do not use out doors or on wet surfaces.**
Failure to follow this instruction could result in electrical shock or personal injury.
- **Do not put anything between vacuum cleaner body and agitator head space.**
Personal injury or product damage could result.
- **This product contains chemicals known to the State of California to cause cancer and reproductive toxicity. Wash hands after handling.**
- **Use extra care when cleaning on stairs.**
- **The hose contains electrical wires. Do not use the hose if it is damaged, cut or punctured.**
Failure to follow this instruction could result in death, or electrical shock.
- **Do not put fingers near the gear.**
Failure to follow this instruction could result in personal injury.



IMPORTANT SAFETY INFORMATION

CAUTION

- **Do not insert objects into vacuum openings.**
Failure to follow this instruction could result in product damage.
- **Do not use the vacuum if any of the openings are blocked. Keep vacuum openings free of dust, lint, hair and anything that may reduce air flow.**
Failure to follow this instruction could result in product damage.
- **Do not use the vacuum cleaner without the tank and/or filters properly installed.**
Failure to follow this instruction could result in product damage.
- **Always clean the dust tank and filters after vacuuming carpet cleaners or fresheners, powders and fine dust.**
These products can clog the filters, reduce airflow and/or cause damage to the vacuum. Failure to clean the dust tank and filters could cause permanent damage to the cleaner.
- **Do not use the vacuum cleaner to pick up sharp or hard objects such as small toys, pins, paper clips, etc.**
They may damage the cleaner or dust tank.
- **Store the vacuum cleaner indoors.**
Put the vacuum cleaner away after use to prevent tripping over it.
- **The vacuum cleaner should not be operated by young children.**
Failure to follow this instruction could result in personal injury or product damage.
- **Only use parts produced or recommended by qualified service technicians.**
Failure to do so could result in product damage.
- **Follow all instructions in the owner's manual. Only use LG recommended or approved attachments and accessories.**
Failure to do so could result in personal injury or product damage.
- **When cleaning stairs, always place the vacuum cleaner at the bottom on the stairs.**
Failure to do so could result in personal injury or product damage.
- **Make sure the filters (exhaust filter and motor safety filter) are completely dry before replacing in the machine.**
Failure to do so could result in product damage.
- **Do not dry the filters in an oven or microwave.**
Failure to follow this instruction could result in fire hazard.
- **Do not dry the filters in a clothes dryer.**
Failure to follow this instruction could result in fire hazard.
- **Do not dry near an open flame.**
Failure to follow this instruction could result in fire hazard.
- **Always turn the vacuum cleaner off before connecting or disconnecting the hose.**
Personal injury or product damage could result.
- **The vacuum cleaner is only intended for household use.**
- **You are responsible for proper assembly and use of your vacuum cleaner.**

Thermal protector :

This vacuum cleaner has a special thermostat that protects the vacuum cleaner in case of motor overheating. If the vacuum cleaner suddenly shuts off, turn off and unplug the vacuum cleaner. Check the vacuum cleaner for possible source of overheating such as full dust tank, blocked hose or clogged filter. If these conditions are found, fix them and wait at least 30 minutes before attempting to use the vacuum cleaner. After 30 minutes, plug the vacuum cleaner back in and turn it on. If the vacuum cleaner still does not run, contact a qualified service technician.

SAVE THESE INSTRUCTIONS

PARTS AND FEATURES

It is important to know your vacuum cleaner's parts and features to assure its proper and safe use. Review these before using your vacuum cleaner.

Common Replacement Parts

HEPA Filter	ADQ73133301
Filter Frame	MEA62331601
Foam Filter	MDJ54988501
Agitator Belt	MAS62023801

To order these parts call
 1-800-243-0000 (U.S.A.)
 1-888-542-2623 (Canada)

Accessory Tools



Crevice Tool

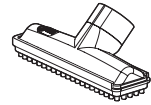

Dusting Brush



Adaptor

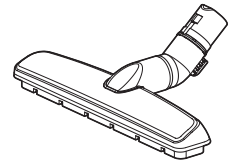

Bare Floor Nozzle

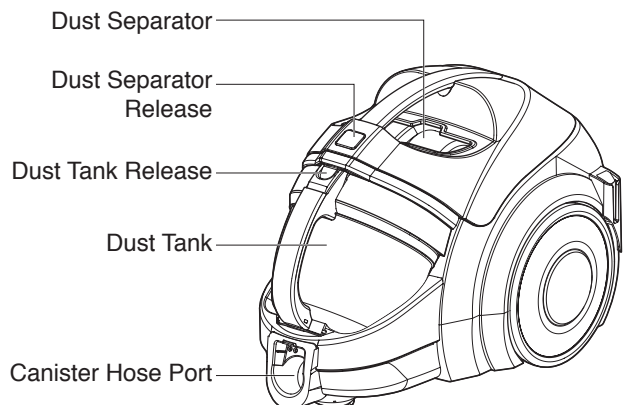
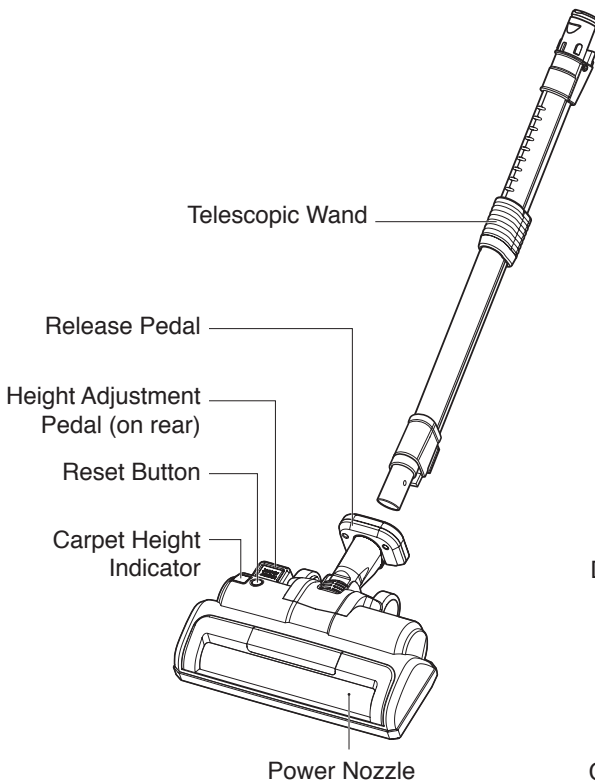
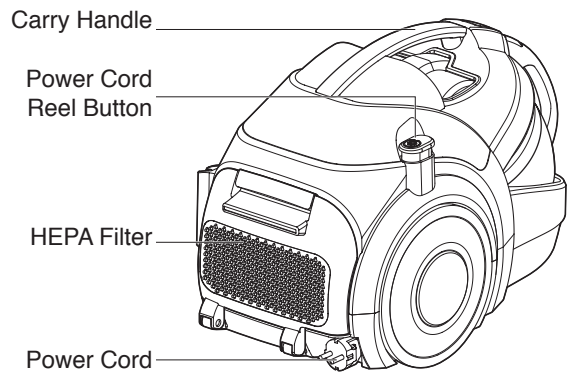
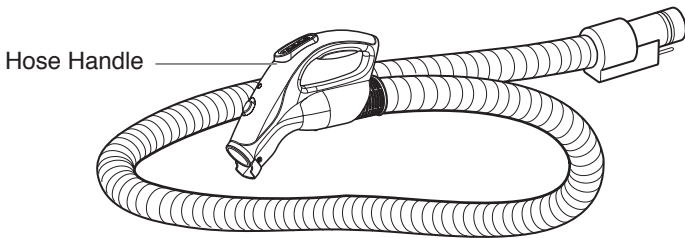

To reduce the risk of shipping damage, your vacuum cleaner is shipped partially unassembled.

Unpacking the Vacuum Cleaner

Carefully unpack the vacuum cleaner and make sure that you have all parts before discarding of any packaging.

Remove any tape and protective film before assembly.

Items that are packed in the box:

1. Canister
2. Dusting Brush (already installed)
3. Crevice Tool (already installed)
4. Hose
5. Telescopic Wand
6. Additional Foam Filter
7. Power Nozzle
8. Adaptor
9. Bare Floor Nozzle

Assembly Parts

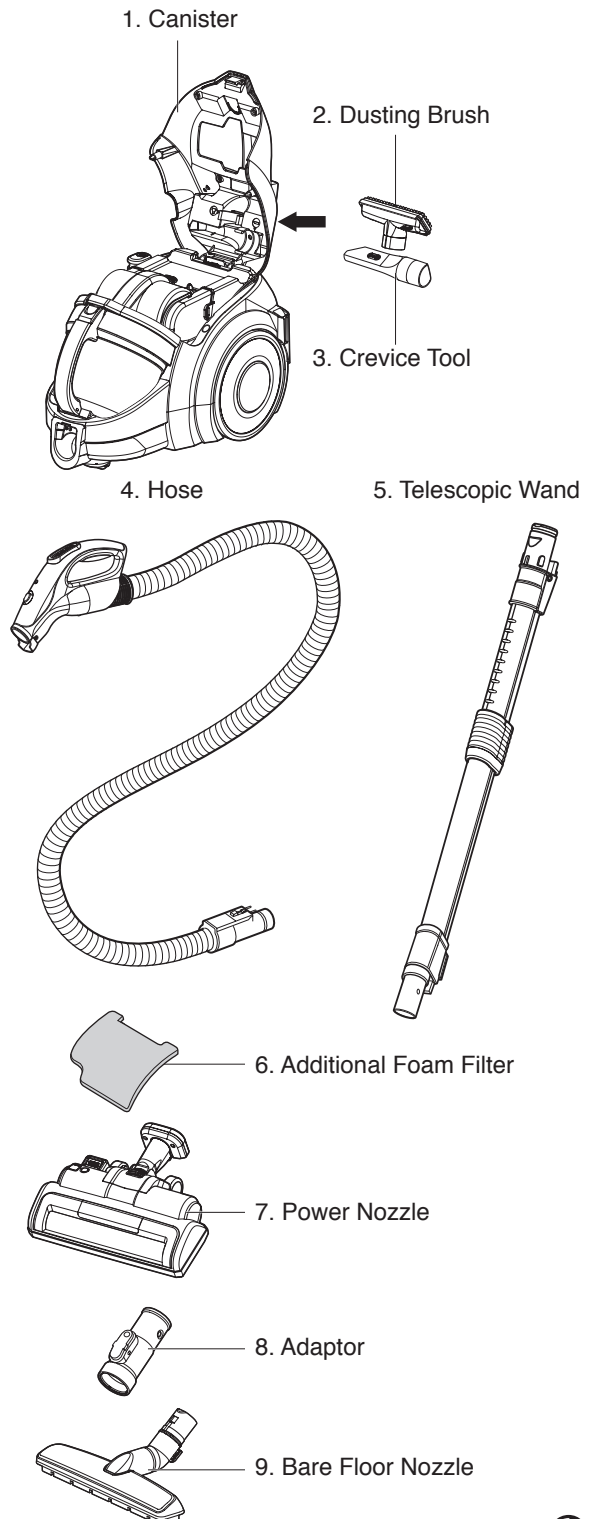

ASSEMBLY

The Vacuum Cleaner Assembly

Canister

1. Inspect Canister
2. Check to see that Dust Tank is properly installed. See the "Emptying the Dust Tank" section for instructions.
3. Check to see that the dust separator and exhaust filters are properly installed. See the "Cleaning the Foam Pre Filter" section for instructions.

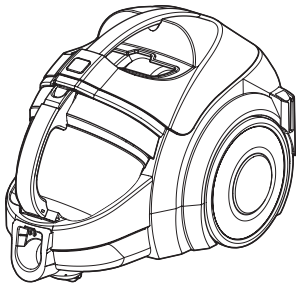

Telescopic Wand

1. Grasp and hold the latch to adjust reach.
2. Pull out the wand to the desired length.

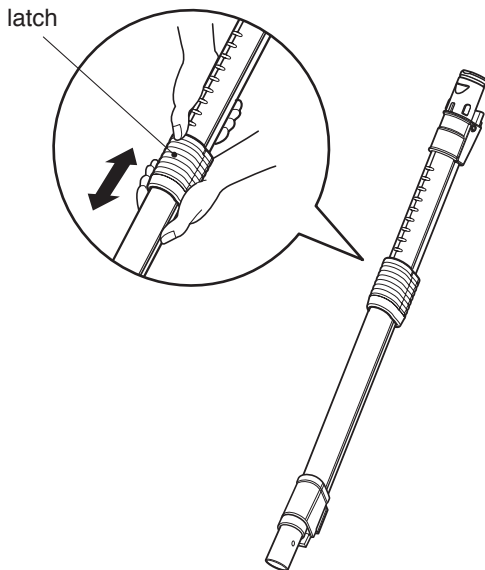

Hose

1. Insert the hose into the canister until it locks into place. To remove the hose from the canister, press the release button and pull the hose out.

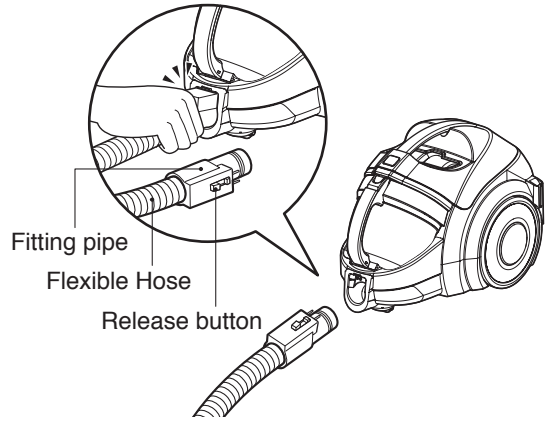

2. Line up the electrical connectors and insert the telescopic wand firmly into hose handle.

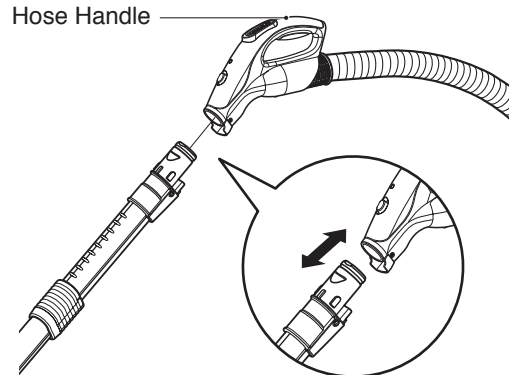

Power Nozzle

- Line up the electrical connectors and push the Power Nozzle into the telescopic wand until it clicks into place.

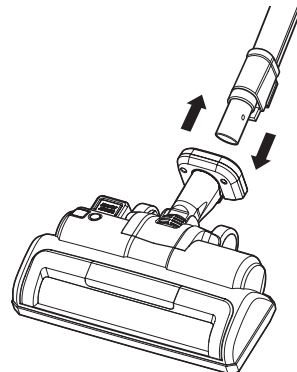

WARNING

Personal Injury and Product Damage Hazard!

DO NOT use outlets above counters. Damage to items in the surrounding area could occur.

Accessory Storage

Your vacuum cleaner features convenient on-board storage of accessories.

- Push the Dust Separator Release Button and open the main cover.

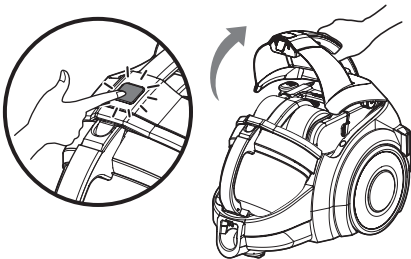

- Clip the dusting brush onto the bottom of the cover with the brush side facing the cover. With the angled edge facing the cover, clip the crevice tool onto the cover.

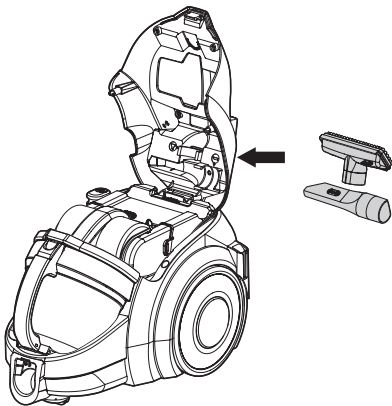

Cord Storage

To release the cord:

Grasp the plug and pull cord to desired cord length.

To store the cord:

Hold plug and press on the cord rewind button on the rear side of handle.

To prevent cord from whipping, hold plug until cord is rewound.

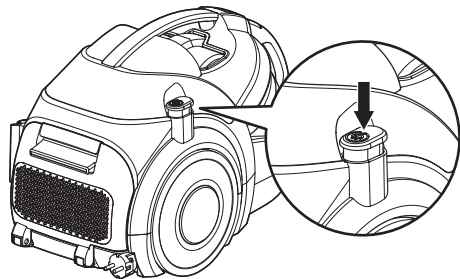

NOTE: To reduce the risk of electric shock, this appliance has a polarized plug (one blade is wider than the other).

This plug will fit in a polarized outlet only one way. If the plug does not fit fully in the outlet, reverse the plug. If it still does not fit, contact a qualified electrician to install the proper outlet. **DO NOT** modify the plug in any way.

OPERATION

WARNING

Personal Injury Hazard

Do not set the vacuum on the stairs, always keep the unit on the floor.

Control Operation

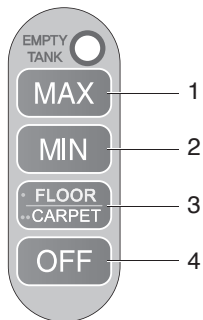

- 1. MAX :** For maximum suction of the vacuum cleaner.
- 2. MIN :** For minimum suction of the vacuum cleaner.
- 3. FLOOR/CARPET :** To turn the agitator on or off.
- 4. OFF:** To turn the canister off.

Adjusting for Carpet Pile Height

To adjust for pile height:

It may be necessary to raise and lower the power head for various carpet pile heights.

Press the right foot pedal to adjust height of the agitator. Each press will raise the agitator one notch.

Suggested pile height settings:

You may need to raise the head of the vacuum cleaner to make vacuuming area rugs and longer pile rugs easier.

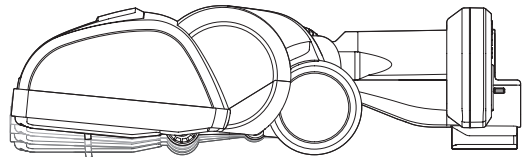

For maximum cleaning performance, the following carpet height settings are recommended:

- L – for bare floors
- ML – for standard carpet
- Higher settings – for very deep pile carpet where easier pushing effort is desired, while maintaining good cleaning performance.

There are 4 settings:

- H = High**
- M = Medium**
- ML = Medium Low**
- L = Low**

NOTE: If the vacuum is difficult to push, change the height adjustment to the next highest setting.

Attention: Special care is required when vacuuming certain types of carpet or flooring. Always check the carpet or floor covering manufacturer's recommended cleaning instructions before vacuuming.

Accessories

Dusting Brush

Functions as a dusting brush and an upholstery nozzle which is useful when cleaning furniture. Attach as shown.

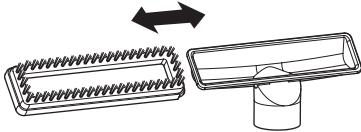

Crevice Tool

The crevice tool can be used for tight corners between cushions and other hard to reach places.

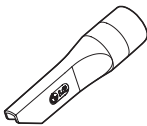

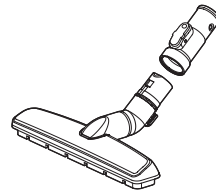

Bare Floor Nozzle

This tool can be used on hardwood and tiled floors.

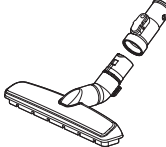

Accessory Use Chart

Accessory	CLEANING AREA							
	Between Cushions	Upholstered Surfaces*	Furniture and Hard Surfaces*	Drapes* (lower power level)	Stairs	Carpeted Floors/ Rugs	Walls	Mattress/ Bedding
Dusting Brush 	●	●	●	●	●	●	●	
Crevice Tool 	●							
Bare Floor Nozzle 			●		●			

* Always make sure attachments are clean before using on fabrics.

OPERATION

Installing Attachments

Using the Dusting Brush

Slide the Dusting Brush over the end of the wand or fit it into the hose handle.

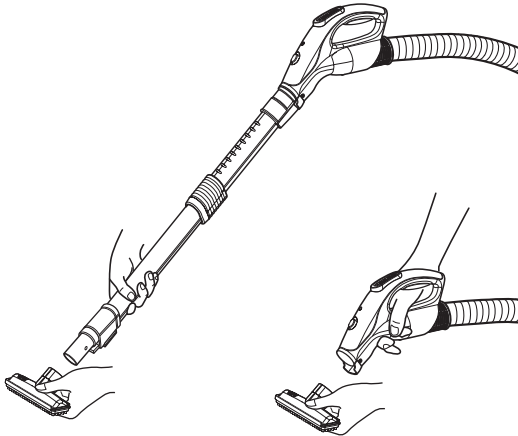

Using the Crevice Tool

Slide the crevice tool over the end of the wand or fit it into the handle.

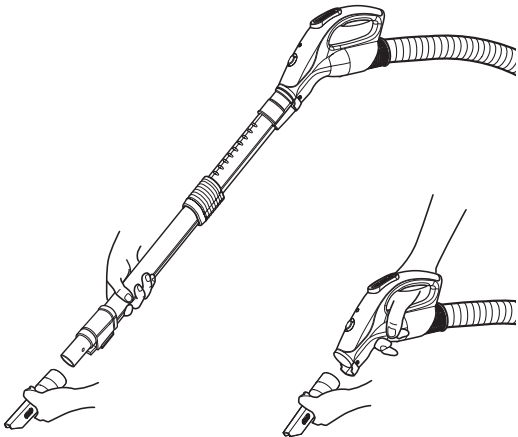

Tips and Tricks

Carpet Edges and Corners:

For tight corners, carpet edges and along base boards, use the dusting brush.

Use the crevice tool for especially hard to reach areas.

Using the Bare Floor Nozzle

The bare floor nozzle is attached to the wand with the adaptor and should be used on hardwood and tiled floors.

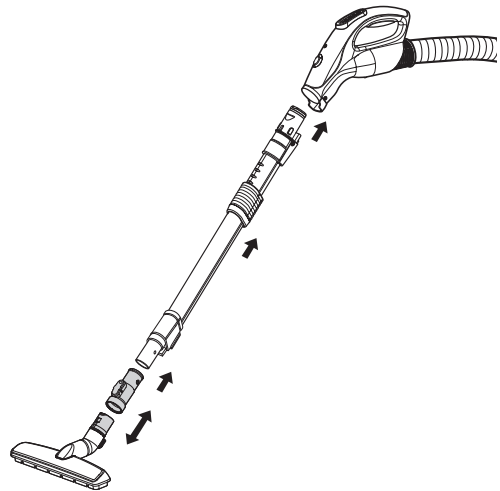

Stairways and Landings

Use the Dusting Brush or Upholstery Nozzle on stairs and landings. Make sure the vacuum cleaner is placed so that it cannot tip or fall. See page 12 for instructions on selecting and using attachments.

Agitator Motor Overload Protection

The agitator has a built-in protection against motor damage should the agitator jam. If the agitator slows down or stops, the agitator overload protector shuts off the agitator motor. The suction motor will remain on at this time.

To correct problem: Turn off and unplug vacuum cleaner, remove obstruction and press the reset button.

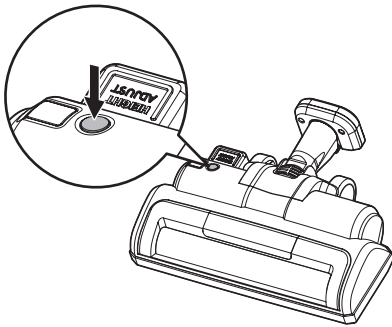

Thermal Overload Protection

This vacuum cleaner has a thermal overload protector which automatically activates to protect the vacuum cleaner from overheating. If a clog disturbs the normal flow of air to the motor, the thermal protector turns the motor off automatically to allow the motor to cool in order to prevent possible damage to the vacuum cleaner.

To correct the problem: Turn the vacuum cleaner off and unplug the power cord. Check for and remove clogs, if necessary. Also check and clean any dirty filters.

Wait approximately 30 minutes and plug the vacuum cleaner in and turn back on to see if the motor protector has reset. The thermal protector system will not reset until the vacuum cleaner has completely cooled down.

CARE & CLEANING

Always follow all safety precautions when cleaning and servicing the vacuum cleaner.

Storing the Vacuum Cleaner

When not in use, store the vacuum cleaner upright or on its wheels. Insert the nozzle clip into its slot on canister bottom and on side of the body.

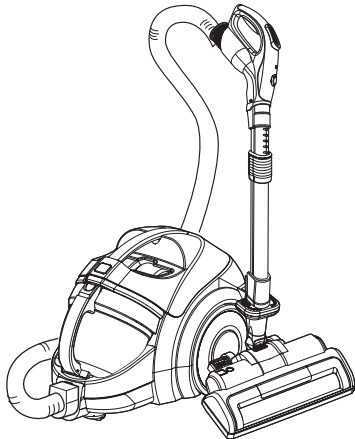
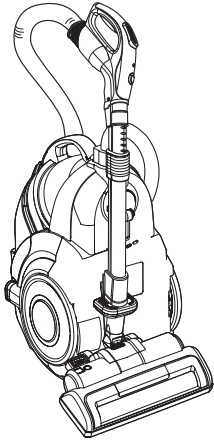

Dust tank and Dust Separator Component

The dust tank and dust separator consist of several key components.

Always make sure that all parts are properly reinstalled after emptying the dust tank.

Never operate the canister without all filters in place!

Never operate the canister with wet filters or components!

Key components:

1. **Dust tank lid** : Open to empty the dust tank.
2. **Dust tank** : Where dirt is collected.
3. **Dust separator lid** : Open to remove debris from dust separator.
- 4~5. **Foam pre filter** : Captures medium to fine particles. It consists of washable filter frame and foam filter.

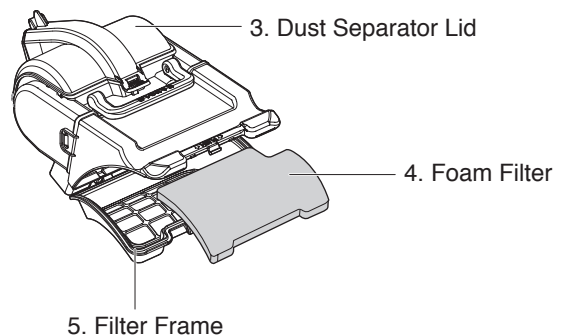
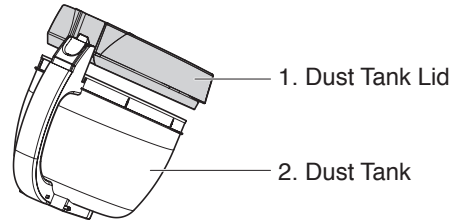

Emptying the Dust Tank

⚠ WARNING

Electrical shock and personal injury hazard.
Always unplug the power cord from the electrical outlet before servicing or performing maintenance on the vacuum cleaner. Failure to do so could result in electrical shock or personal injury.

For maximum performance, always empty the dust tank when the indicator on the hose handle is lit, or when the dust tank level reaches the MAX line.

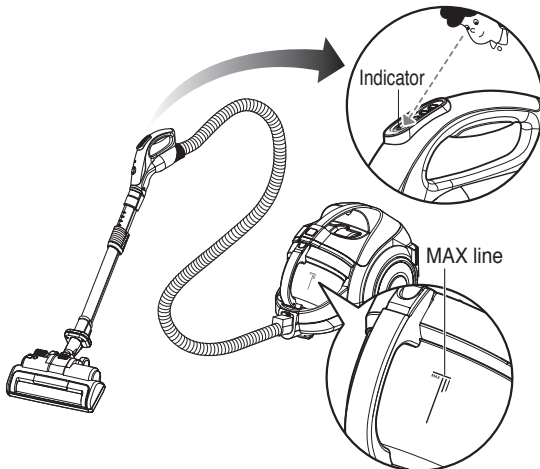

TO REMOVE DUST TANK, Grasp the handle of dust tank and then press the dust tank release. Pull out the dust tank.

Tank separation lever

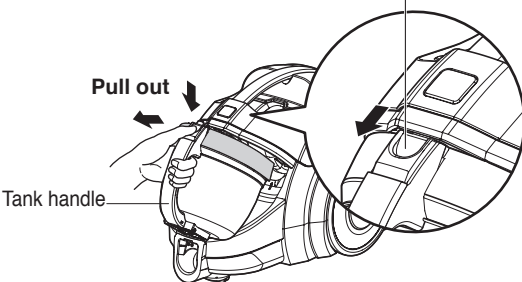

TO EMPTY DUST TANK, lift the dust tank cover off and empty the tank as shown.

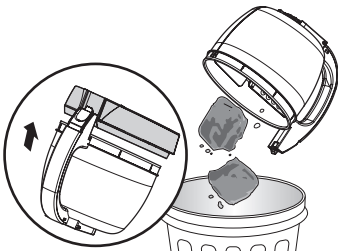

Cleaning the Dust Tank

For optimal performance, clean the dust tank regularly.

To Clean the Dust Tank:

1. Remove the dust tank from the vacuum cleaner.
2. Wash the dust tank and cover of dust tank.
3. Dry completely away from direct sunlight.

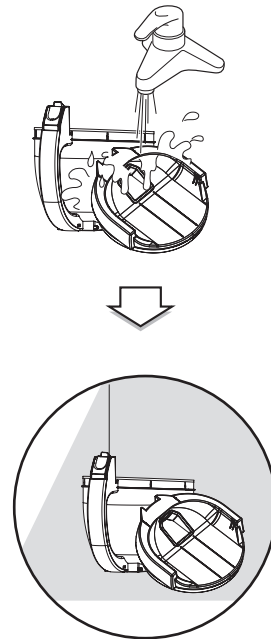

NEVER operate the canister with wet components!

CARE & CLEANING

Cleaning the Foam Pre Filter

CAUTION

A wet filter can cause permanent damage to the vacuum cleaner. Be sure filters are completely dry before reinstalling.

For optimal performance, check the filters every 2 months and clean when necessary.

To Clean the foam pre filter:

1. Grasp the handle of canister and then push the dust separator release button. Open the cover of canister.

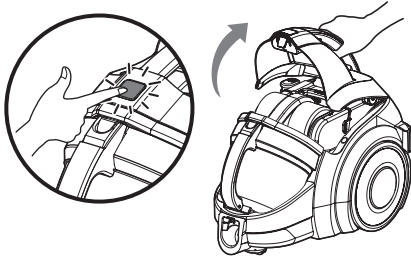

2. Grasp the handle of the dust separator and take it out.

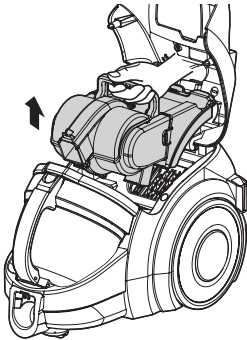

3. Open the dust separator lid by pulling the lid cover lever and remove dirt.

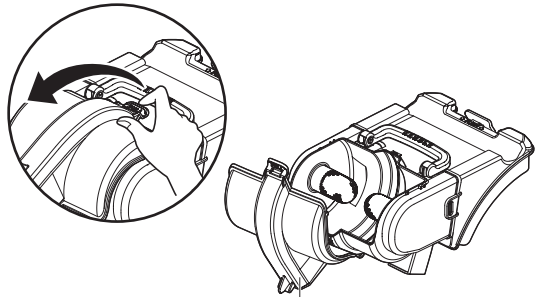

Dust Separator Lid

4. Open the pre filter cover by pulling the pre filter cover lever. Take out the foam filter and remove the filter frame from the dust separator.

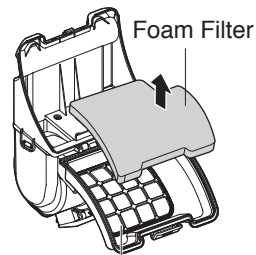
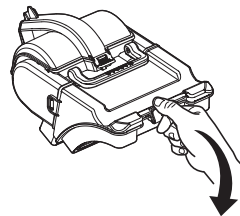

Filter frame

- Shake out any excess dust or debris and rinse the foam filter & filter frame with clean water.

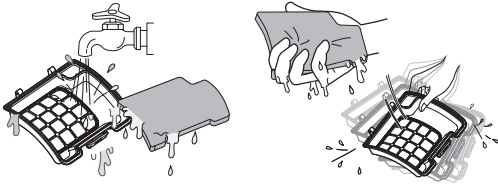

- Dry completely away from sunlight.



NEVER operate the vacuum cleaner with wet filters or components!

If you notice a loss of suction and cleaning the foam filter does not help, you need to replace the foam filter. You can purchase additional foam filters from LG by calling 1-800-243-0000(U.S.A), 1-888-542-2623 (Canada) and asking for parts on page 6.

Cleaning the HEPA Filter

For optimal performance, check the filter every 6 months and clean when necessary.

To Clean the HEPA Filter:

- Remove the HEPA filter cover.

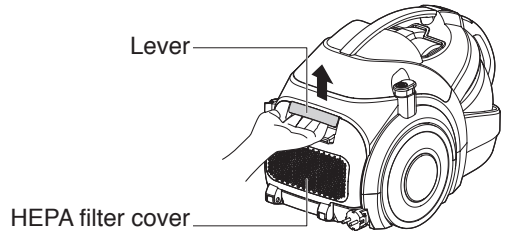

- Separate the HEPA filter by pushing the button.

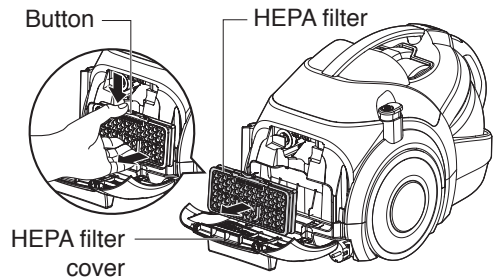

- Wash the filter thoroughly in flowing water.



- Remove moisture.



- Dry completely away from sunlight.

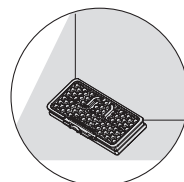

CARE & CLEANING

Agitator Maintenance

⚠ WARNING

Electrical shock and personal injury hazard. Always unplug the vacuum cleaner before servicing. Failure to do so could result in electrical shock or personal injury.

Frequently check the agitator brush area for hair, string and lint buildup.

Remove the Agitator Brush Cover:

1. Unplug the canister. Disconnect power nozzle from the wand.
2. Turn the power nozzle over, so that the agitator is facing up.
3. Set the power nozzle on a cloth or a smooth surface. Remove the six screws on the bottom of the head and remove the cover.

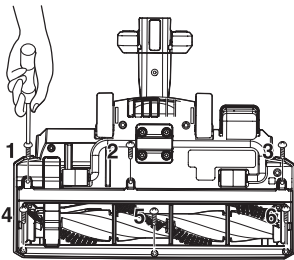

4. Carefully remove any accumulated string, hair, etc. from the agitator and the agitator area.

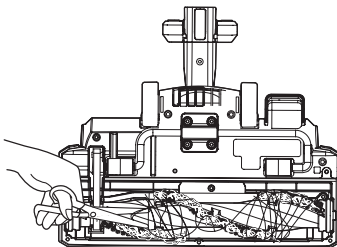

To reinstall the cover, reverse the steps above.

Replacing the Agitator Belt

⚠ WARNING

Electrical shock and personal injury hazard. Always unplug the vacuum cleaner before servicing. Failure to do so could result in electrical shock or personal injury.

If the belt breaks, follow the steps below to replace the agitator belt.

To Replace the Belt:

1. Remove the agitator brush cover.
2. Lift the agitator straight out.

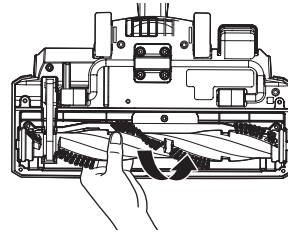

3. Unhook the old belt from the drive pulley. Make sure no pieces of the broken belt are trapped in the agitator or drive pulley area.

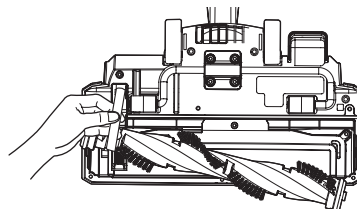

4. Hook the new belt over drive pulley of agitator motor.

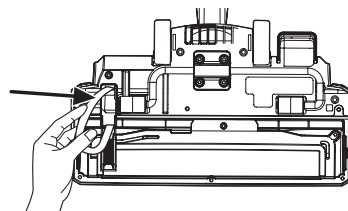

5. Fit the agitator through the belt, making sure the belt is aligned with the pulley section of the agitator.

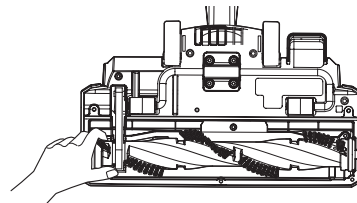

6. Lower the agitator into place, making sure the oval shaped tabs fit into the indents on the head.

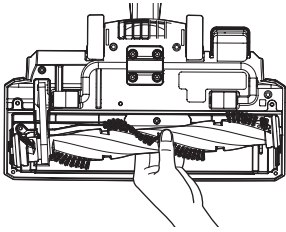

7. Reinstall the agitator brush cover.

Removing Clogs

⚠ WARNING

Electrical shock and personal injury hazard. Always unplug the vacuum cleaner before servicing. Failure to do so could result in electrical shock or personal injury.

If you notice a loss in suction, first check the filters as described on page 16. If the filters are clean, there may be a clog. The arrows show areas where clogs are most likely to occur.

To check for clogs:

1. Check the hose where it connects to the canister by pressing the release button on the top end of the hose.

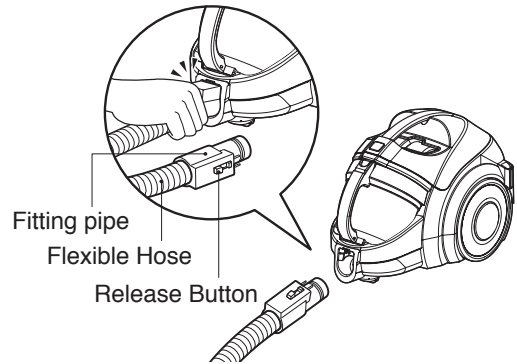

2. Check the power nozzle where it connects to the wand by pressing the power nozzle release pedal.

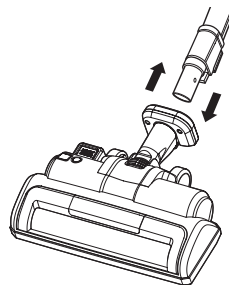

3. Remove the dust separator and check the dust separator inlet where it connects to the canister.

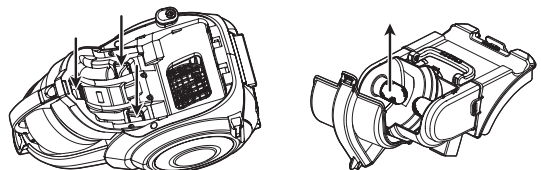

CARE & CLEANING

4. Turn the power nozzle over and check the agitator inlet.

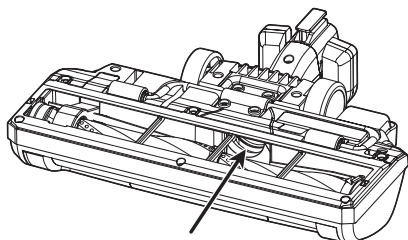

5. Separate the wand and hose and check for clogging.

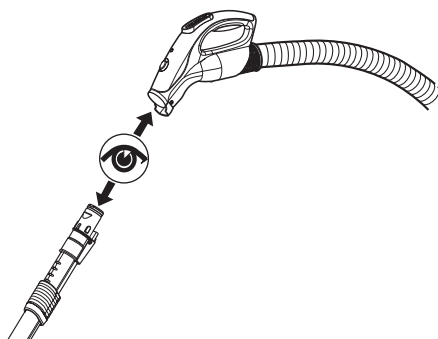

Cleaning the Exterior of the Vacuum Cleaner

⚠ WARNING

Electrical shock and personal injury hazard. Always unplug the vacuum cleaner before servicing. Failure to do so could result in electrical shock or personal injury.

Wipe the exterior of the vacuum cleaner with a clean, soft cloth that has been dipped in water and wrung dry.

DO NOT allow water to enter any openings in the vacuum cleaner.

DO NOT clean tools in a dishwasher or clothes washer. Wash tools in warm soapy water, rinse and allow to air dry completely.

DO NOT use tools if they are wet.

Review this chart to find do-it-yourself solutions for minor performance problems. Any service or repair needed, other than as described in this Owner's Manual, should be performed through your local LGE service center.

WARNING

Electrical shock and personal injury hazard.

Always unplug the vacuum cleaner before servicing. Failure to do so could result in electrical shock or personal injury.

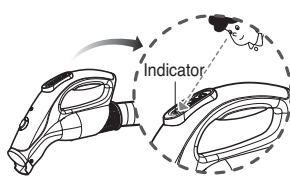
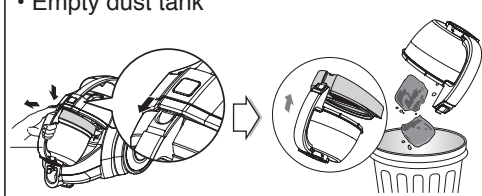
PROBLEM	POSSIBLE CAUSE	POSSIBLE SOLUTION
Vacuum cleaner will not run	<ul style="list-style-type: none"> • Unplugged at wall outlet • Hose is not connected to the body properly • Dust tank improperly installed • Clogged hose, wand, nozzle 	<ul style="list-style-type: none"> • Make sure cord is plugged into a functioning outlet. • Remove the hose from the body and reconnect it properly. • Make sure all dust tank components and filters are installed correctly. • Check for clogs.
Poor suction	<ul style="list-style-type: none"> • Full or clogged dust tank and filters • Dust tank improperly installed • Clogged hose, wand, nozzle 	<ul style="list-style-type: none"> • Empty dust tank and clean filters. • Make sure all dust tank components and filters are installed correctly. • Check for clogs.
LED on the hose is lit 	<ul style="list-style-type: none"> • Dust tank is full • Power is on without dust tank • Rotating plate in the dust tank is restricted because of obstruction 	<ul style="list-style-type: none"> • Empty dust tank • Reattach dust tank • Remove obstruction. 
Unit runs louder than usual	<ul style="list-style-type: none"> • Clogged hose, wand, nozzle 	<ul style="list-style-type: none"> • Check for clogs.

TROUBLESHOOTING

PROBLEM	POSSIBLE CAUSE	POSSIBLE SOLUTION
<p>Musty or unusual smell</p>	<ul style="list-style-type: none"> • Smell of new motor • Old and dirty filters • The foam filter or exhaust filter is wet. 	<ul style="list-style-type: none"> • New vacuum cleaner smell should disappear in 1-2 months. • Empty dust tank and clean filters. • Dry the foam filter or exhaust filter completely away from sunlight.
<p>Agitator does not turn</p>	<ul style="list-style-type: none"> • Switch is off (unit is in bare floor mode) • The power nozzle is disconnected with the wand. • Agitator motor overload protection is tripped (brush is jammed) • Belt broken • The wand is disconnected with the hose. 	<ul style="list-style-type: none"> • Turn on agitator power switch. • Properly connect the power nozzle to the wand. • Unplug the vacuum cleaner and check the agitator for obstructions and reset the unit. • Replace belt. • Properly connect the wand to the hose.

MEMO
