

Thank you for purchasing
an 8x12 Santa Rosa Garden
Shed from Outdoor Living Today.
Please take the time to
identify all the parts prior
to assembly.



Safety Points and Other Considerations

Our products are built for use based on proper installation and normal residential use, on level ground. Please follow the instruction manual when building your Cabana and retain the manual for future maintenance purposes.

Some of the safety and usage measures you may wish to consider include:

- snow load ratings vary by geographical location. If heavy or wet snowfall occurs, it is advisable to sweep the snow off the roof(s).
- if the product is elevated, any structural and building code requirements are solely the customer's responsibility, and should be abided by.
- in high or gusty wind conditions it is advisable to keep the structure securely grounded.
- have a regular maintenance plan to ensure screws, doors, windows and parts are tight.

Customer agrees to hold Outdoor Living Today Partnership and any Authorized Dealers free of any liability for improper installation, maintenance and repair.

In the event of a missing or broken piece, simply call the Outdoor Living Today Customer Support Line @ 1-888-658-1658 within 30 days of the delivery of your purchase. It is our commitment to you to courier replacement parts, free of charge, within 10 business days of this notification. Replacement parts will not be provided free of charge after the 30 day grace period.

**Thank you for purchasing our 8x12 Santa Rosa Garden Shed.
Please take the time to identify all the parts prior to assembly.**

Parts List:

A. Floor Section

- 3 - 45 1/2" x 75" - Floor Joist Frames
- 3 - 45 1/2" x 21" - Floor Joist Frames
- 2 - 45 1/2" x 75" - Plywood Floor - Large
- 2 - 45 1/2" x 21" - Plywood Floor - Small
- 6 - 1 1/2" x 3 1/2" x 72" - Floor Joists
- 17 - 1" x 5 1/2" x 45" - Deck Boards for Porch
- 10 - 1 1/2" x 3 1/2" x 68" - Floor Runners
- 1 - 31 3/4" long and angle cut. (Threshold for Floor and Deck)

B. Wall Section

- 4 - 45 1/2" x 75" - Wall Panels - Bottom Wall Plates Unattached
- 4 - 1 1/2" x 2 1/2" x 45 1/2" - Bottom Plates
- 3 - 45 1/2" x 75" - Window Wall Panels
- 1 - 12" x 73" - Narrow Porch Wall Panel
- 3 - Functional Window Inserts

Door, Door Jambs & Header

- 1 - 1 1/2" x 3" x 73" - Door Jamb
- 1 - 2" x 3" x 45 1/2" - Door Header
- 1 - 31 1/2" x 40" - Bottom Door
- 1 - 31 1/2" x 32" - Top Door
- 2 - 2 1/2" x 1/2" x 72" - Interior Vertical Door Stops (approx.)
- 1 - 2 1/2" x 1/2" x 36" - Interior Top Horizontal Door Stop (approx.)

Gable Walls

- 2 - Rear Gable Walls - Triangular Shaped with Designer Shingles
- 2 - Middle Gable Walls- Triangular Shaped with Siding flush to frame
- 1 - Front Triangular Gusset Gable - Designer Shingles

Top Wall Plates

- 3 - 3/4" x 2 1/2" x 32" - Rear Top Plates -
(2 pieces Angle cut on end, 1 piece straight cut both ends)
- 2 - 3/4" x 2 1/2" x 72" & 19" Front Top Plate - Straight cut on ends.
- 4 - 3/4" x 2 1/2" Side Top Plate - Angle cut on length - 66 3/4"

C & D. Rafter and Roof Section

- 18 - 1 1/2" x 3 1/2" x 56 1/2" - Rafters (angle cut)
- 2 - 3/4" x 4 1/2" x 52 1/2" - Ridge Boards
- 2 - 3/4" x 4 1/2" x 84" - Ridge Boards
- 2 - 1/16" x 3" x 7" - Metal Ridge Board Connectors
- 4 - 1/2" x 4 1/2" x 68 1/4" - Soffits (Both Sides)
- 2 - 3/4" x 3 1/2" x 72" - Roof Gussets - (angle cut on ends)

Roof Panels

- 4 - Outside Rear Roof Panels (Shingles overhanging roof battens on 1 end)
- 2 - Middle Roof Panel (Shingles flush with roof battens)

Porch Section

- 2 - 3 1/2" x 3 1/2" x 74" Long Porch Posts
- 1 - 3 1/2" x 3 1/2" (short) Deck Post
- 3 - Hand Rail Sections
- 2 - 3/4" x 3 1/2" x 45" - Top Plate Front Extension
- 2 - 1" x 4 1/2" x 74" - Front Wall Trim/Supports (one with 2 1/2" w Filler Strip Attached to back. One with 4 1/2" Filler Strip Attached to back).
- 4 - Corner Brackets
- 12 - Post Base Trims - 1/2" x 1 1/2" x 4"
- 2 - 1/8" x 45" x 48" - Porch Ceiling Veneer

E. Miscellaneous Section

Ridge Caps

- 20 - Cedar Roof Ridge Caps - Includes 2 Undercourse Caps- (Undercourse are lower grade Caps that will be covered)

Bottom Skirting

- 2 - 1/2" x 4 1/2" x 48 1/2" - Front Bottom Skirting
- 8 - 1/2" x 4 1/2" x 45 1/4" - Side and Rear Bottom Skirting

Corner & Sidewall Trim

- 6 - 1/2" x 2 1/2" x 79" - Narrow Trim
- 1 - 1/2" x 2 1/2" x 75" - Ream Seam Trim
- 2 - 1/2" x 2 1/2" x 75" - Rear Filler Trim
- 2 - 1/2" x 4 1/2" x 82" - Rear Wide Trim
- 2 - 1/2" x 2 1/2" x 44" - Horizontal Trim above Door
- 1 - 1/2" x 2 1/2" x 72" - Porch Trim
- 1 - 1/2" x 2 1/2" x 72" - Door Trim

Facia Trim

- 2 - 3/4" x 3 1/2" x 58" - Back Facia- Angle cut on ends
- 4 - 3/4" x 3 1/2" x 72 1/4" - Side Facia
- 2 - Front Gusset Facia (shingles)

Filler Shingles (6" wide)

- 12 pcs - Long
- 4 pcs - Short
- 2 pcs - Rear Gable Walls 1-16" long 1 - 7 1/2"l (trimmed on top)

Misc. Pieces

- 3 - Flower Boxes
- 3 - Facia / Trim Detail Plates
- 1 - Pentagon Detail Plate
- 1 pc - Spare Wall Siding
- 2 pcs - Spare Shingles- use to shim door, etc

Hardware Package

- 2 1/2" Screws
- 2" Screws -
- 2 1/4" Nails for Deck Boards -
- 1 1/2" Screws -
- 1 1/4" Screws -
- 1 1/2" Shingle Nails
- 1 1/4" Finishing Nails
- 3/4" Screws Silver and Black Screws
- 8 - Simpson Strong Tie Rafter Connectors - angled @22 1/2
- 8 - 90 degree Simpson Strong Tie for Front Gusset Gable & Roof
- 1 - Door Pull Handle
- 1 - Exterior Barrel Bolt - Black
- 1 - Interior Barrel Bolt - Silver
- 4 - Black Tee Hinges for Dutch Door
- 2" long Black Screws for Hinges
- 1 - Square Drive Screw Bit

Tools Required:

- Work Gloves and Safety Glasses
- Screw Gun with square drive and star bits
- Level
- 2 Large Ladders
- Hammer
- Wood Clamps

A. Floor Section

Exploded view of all parts necessary to complete Floor Section. Identify all parts prior to starting.

Note, Floor Footprint is 136 1/2" deep x 96" wide.

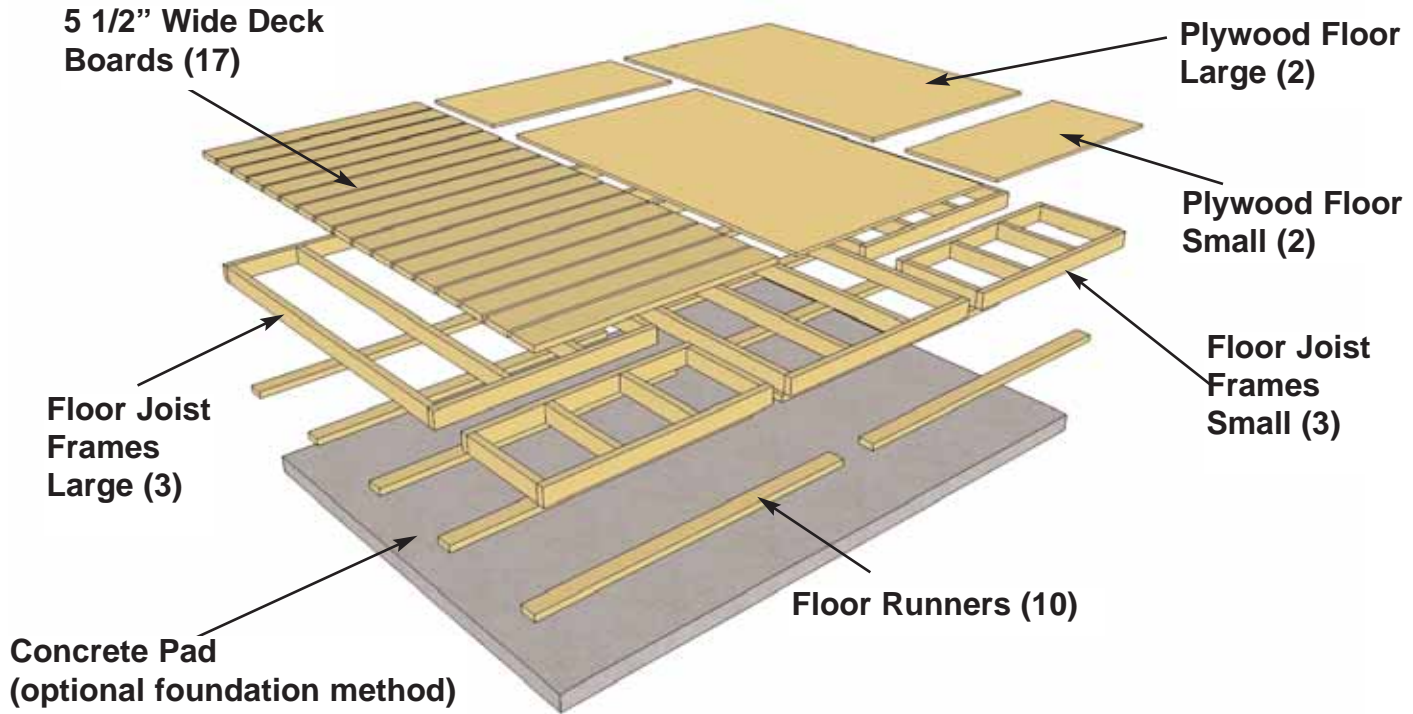

Flush with framing



- 1.** Lay out **Large Floor Joist Frame and 2 Floor Joists** as illustrated above. Position Joists equally in Floor Joist Frame. Use **Small Floor Joist Frame** as a template to determine joist position. Position Joist so flush with framing.

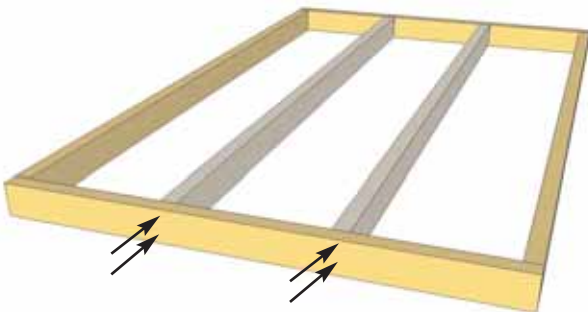

- 2.** When correctly positioned, attach each Joist with 4 - 2 1/2" screws (2 per end). **You can find the Square Drive Screw Bit in the Hardware Kit Bag.**

3. Lay out **Floor Joist Frames** as illustrated at left. There are 3 larger and 3 smaller Frame Sections. The Footprint for the floor when attached together will be 136 1/2" Deep x 96" Wide.

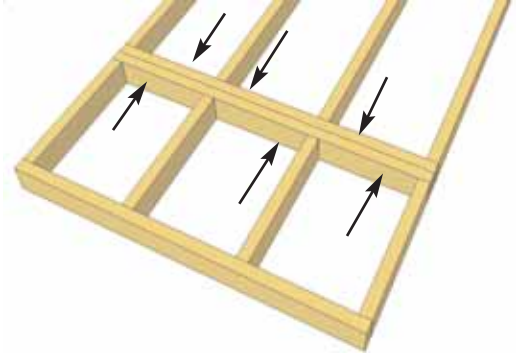
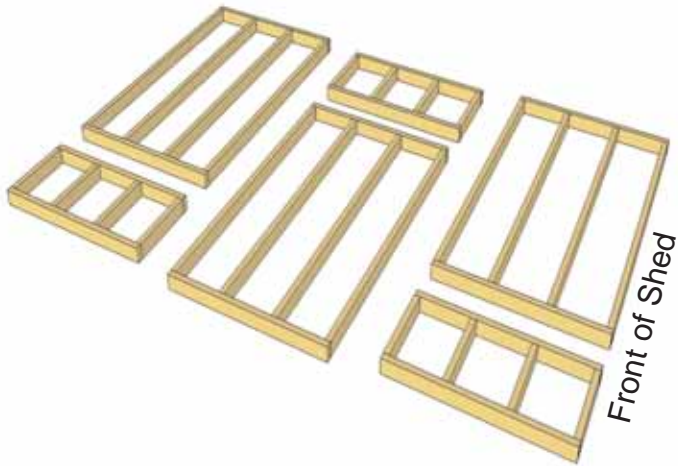

4. Attach each large and small floor joist frames together with 6 - 2.5" screws per section.

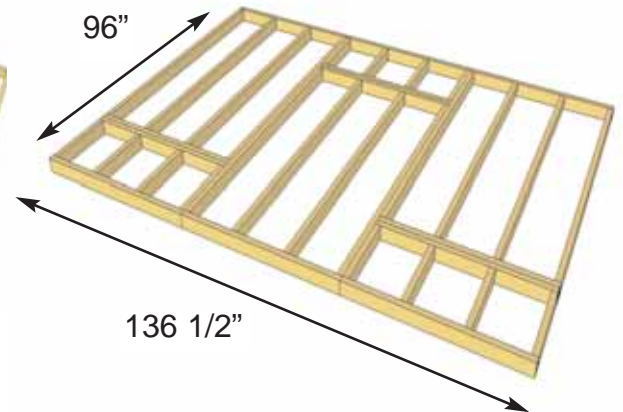
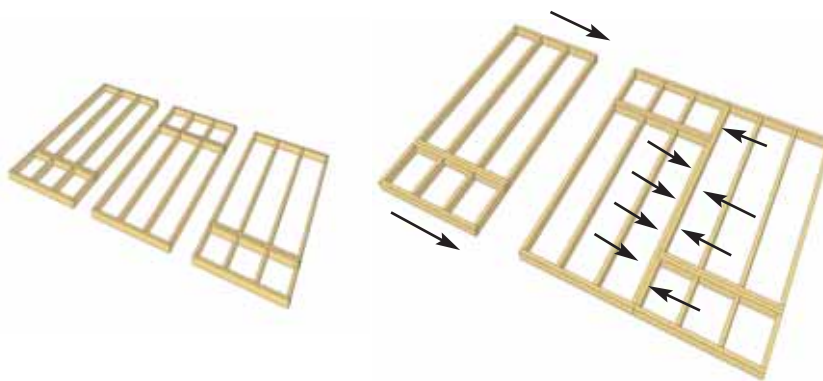

5. Complete all large and small frame attachments. Screw each completed section together with 8 - 2.5" screws.

6. When completed, your floor footprint should be 136 1/2" Deep x 96" Wide.

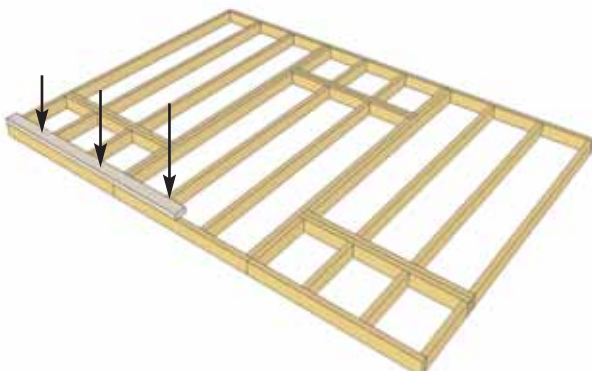

7. Attach **Floor Runners** to completed floor frame. There are 2 floor runners per 136 1/2" side and 5 completed runners in total. Use 6 - 2.5" screws per Runner.

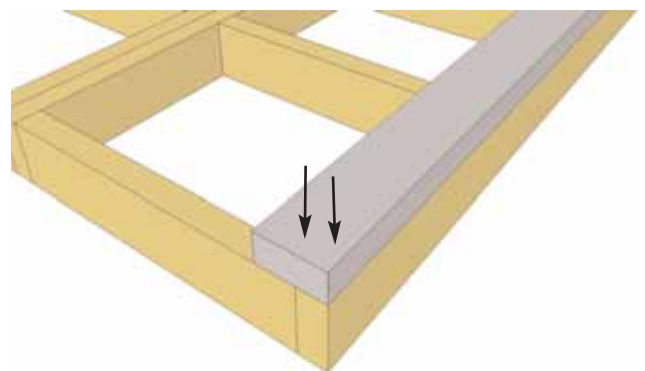

8. Make sure Runners are flush with outside and front and rear floor framing but not overhanging.

9. Position **Plywood Floor** pieces (4) on top of completed floor joists. Plywood will sit flush with outside of floor joist frame.

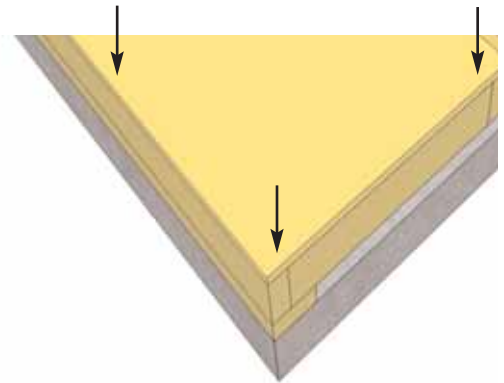
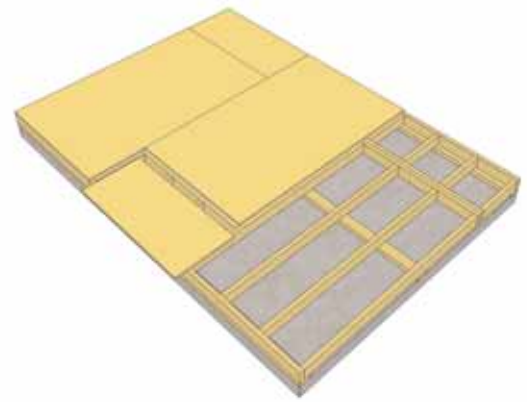
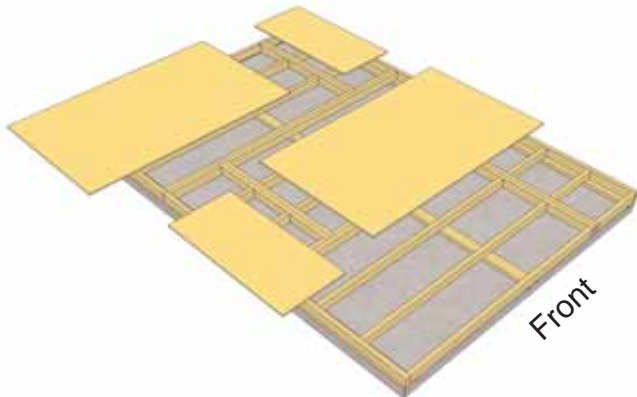

Hint: Use a chalk line to mark location of floor joists to determine screw placement.

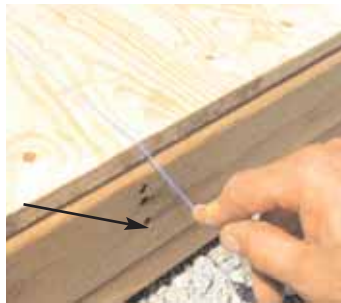

10. With Plywood positioned correctly on floor framing, attach with 1 1/4" screws. Use screws every 16".

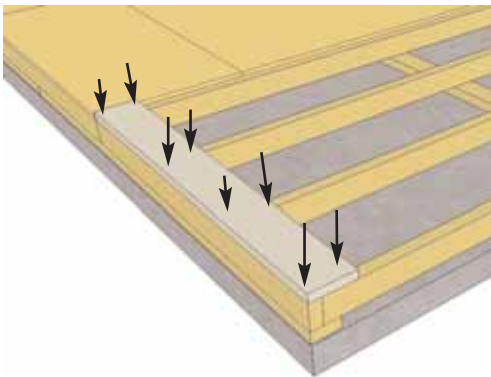

11. Attach 17 pieces of 1" x 5 1/2" x 45" **Deck Boards** using 8 - 2 1/4" deck nails per piece. Attach both outside pieces first and equally space all others on the floor before attaching.

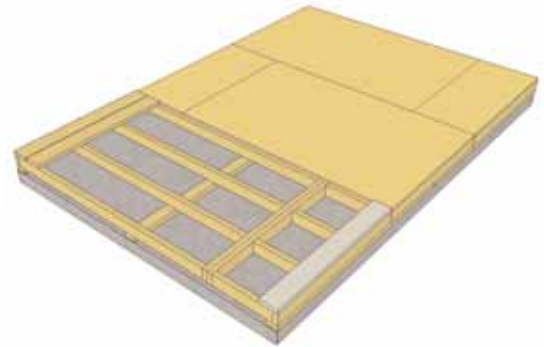

Lay all Deck Boards down evenly spaced prior to attaching.

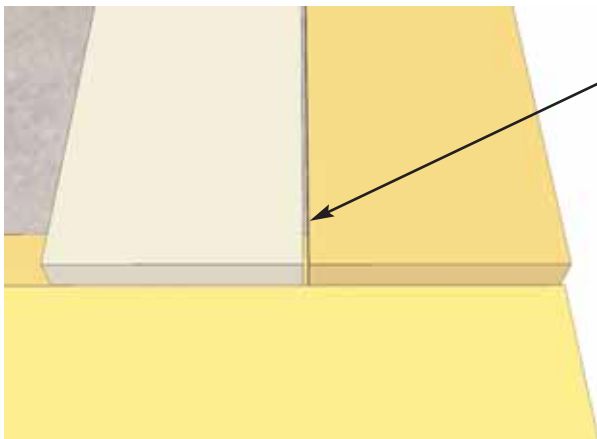

Important - Make sure floor is level before moving on to wall section. Use a level to confirm and shim floor joists as required.

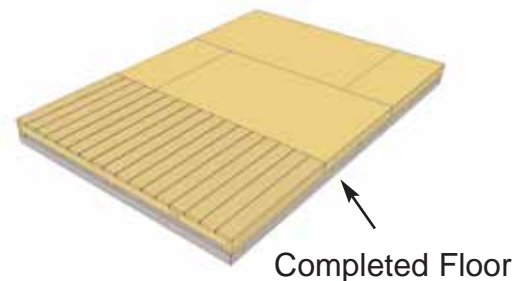

B. Wall Section

Exploded view of all parts necessary to complete the Wall Section. Identify all parts prior to starting.

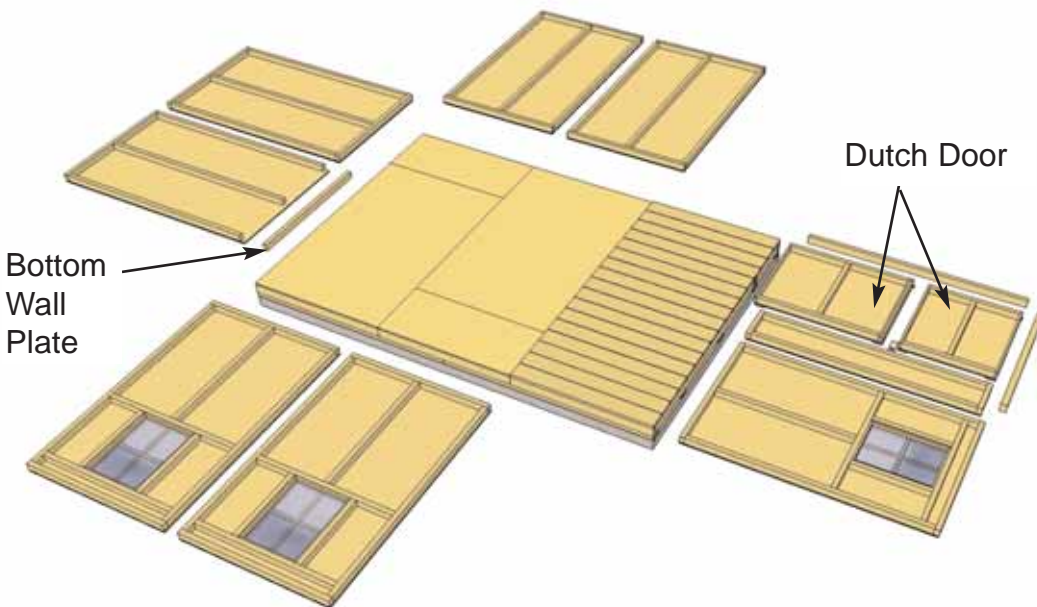
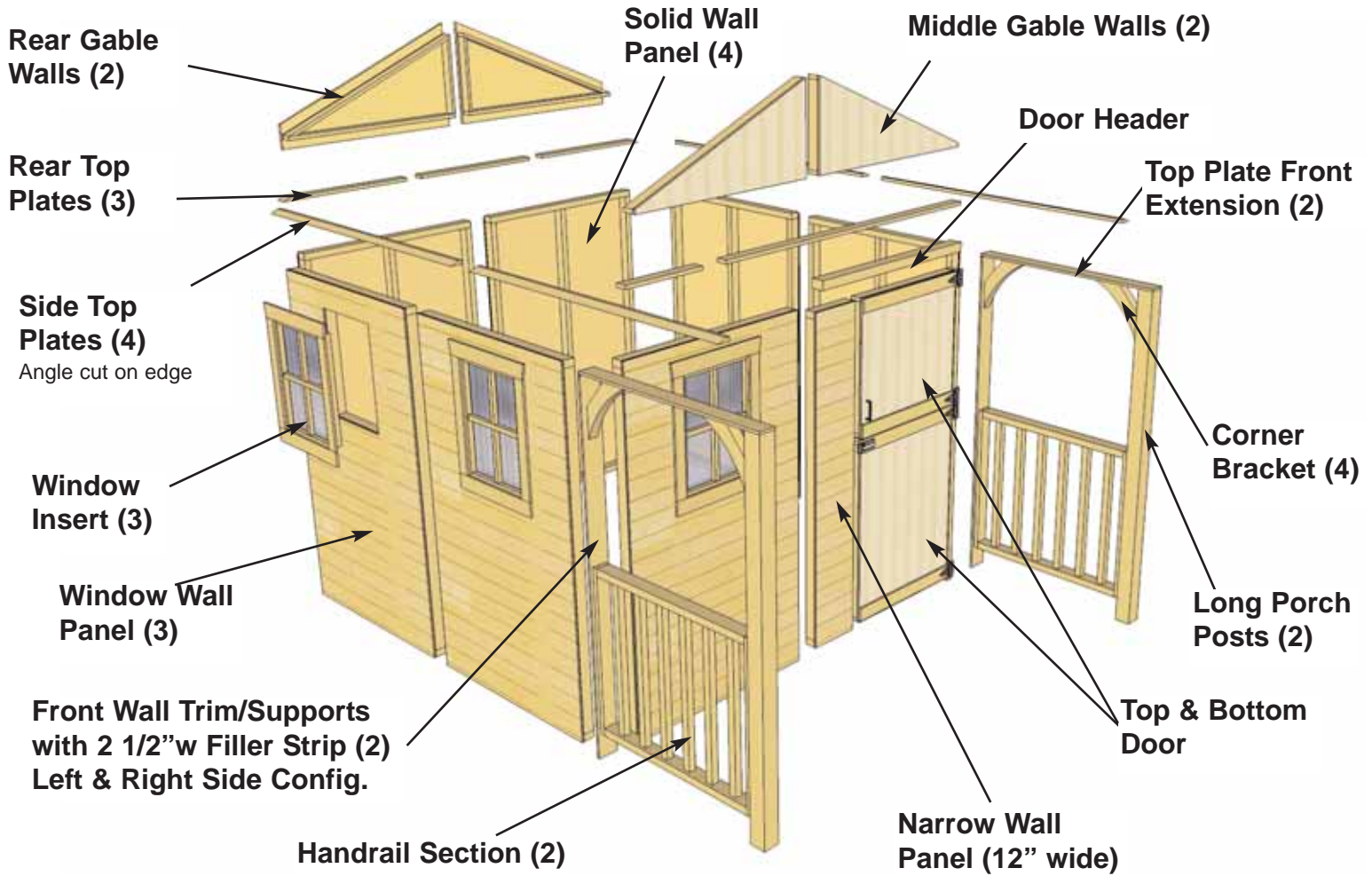

12. Lay out all the wall panels and become familiar with their location.

On Standard Kits, there are 3 **Window Wall Panels**, 4 **Solid Wall Panels**, 1 **Narrow Wall Panel** and **Dutch Door** (top and bottom sections).

Make sure to position panels right side up so water is directed away from and not into shed. Look at window wall panels to determine proper wall position to confirm.

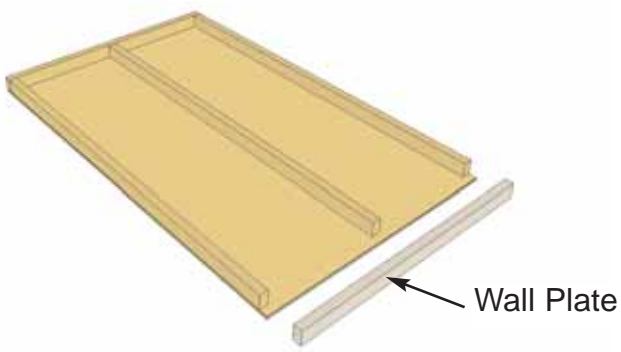

13. Starting with All **Solid Wall Panels**, carefully lay panel face down. Position and attach **Bottom Wall Plates** to bottom of wall studs of each wall panel with 3 - 2 1/2" screws. Position so Wall Plates are flush with framing.



Note,
You may prefer to install Windows in the Miscellaneous Section at the end of assembly.

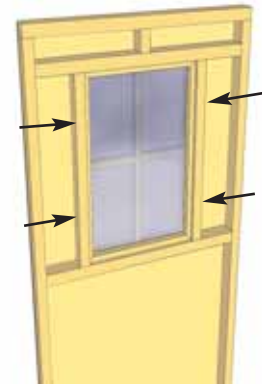

14. Locate **Window Inserts**. Place Window Insert into wall opening tight to wall siding. On the inside, shim Window Insert evenly in cavity. Kits include one additional shingle for shimming of the window. When properly positioned, secure Window Insert to wall framing cavity with 4 - 2" screws.

15. Starting at Rear Corner, position a Wall Panel on top of plywood floor. Depending on your preference, you may use a solid or window wall panel in this position. If using a solid wall, make sure panel is facing up.

Important:
Make sure all walls are aligned in their upright position. If not, water may leak into your playhouse. Unsure if panel is facing up or down? check siding on window wall panel to match alignment.

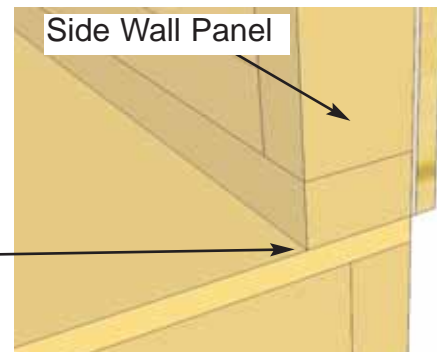
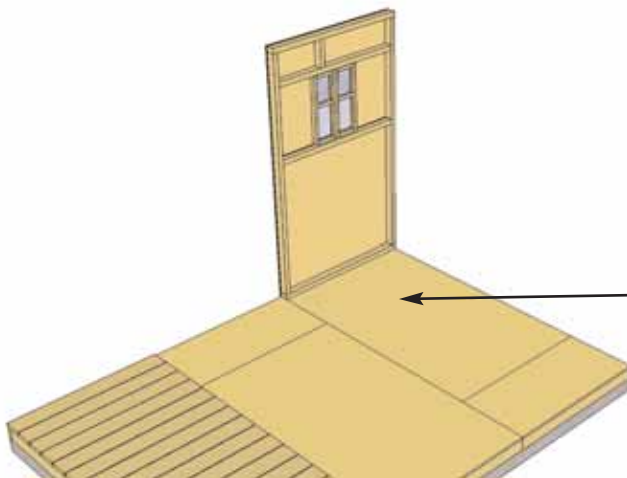

Outside 2x3 Plate of wall panel is flush with outside of plywood when properly aligned.

16. The side wall panels will sit flush at the end of the plywood floor with the front and rear panels sandwiching between them. **Note:** Siding will overhang the floor by approx. 1/2"



Optional - Caulking seams will help prevent moisture from entering at seam.
Caulking not included in kit.

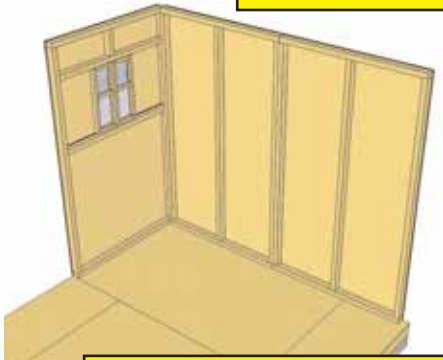
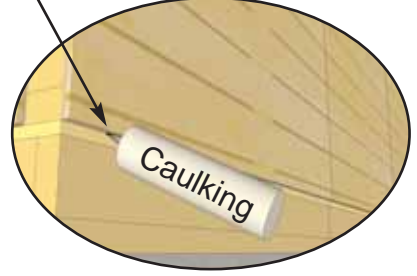
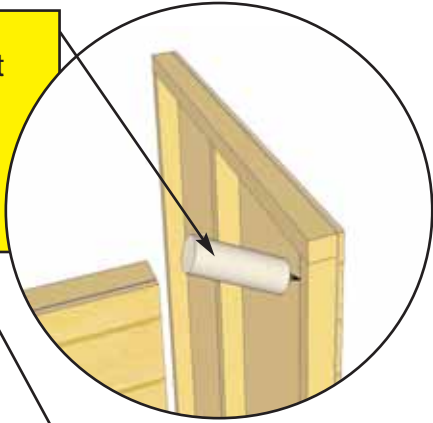

Do Not Attach Walls To Floor Until Step 22.

17. Position rear corner wall into place and attach together with 3 - 2 1/2" screws. Screw at the top, middle and bottom of 2x3 stud. Start positioning and securing wall panels on your floor.

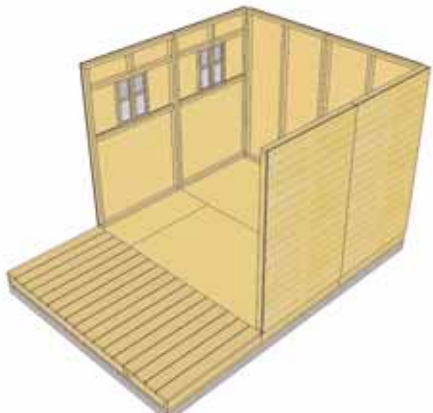
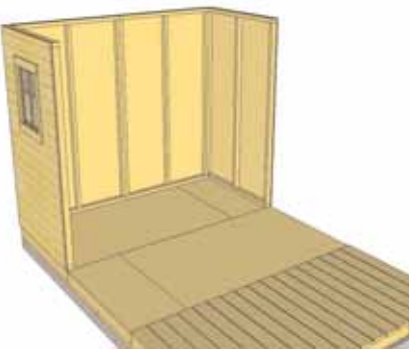

18. Be sure to correctly position wall panels so siding overhangs your floor and wall framing is flush with floor framing. Continue to attach walls together as per **Step 17.**

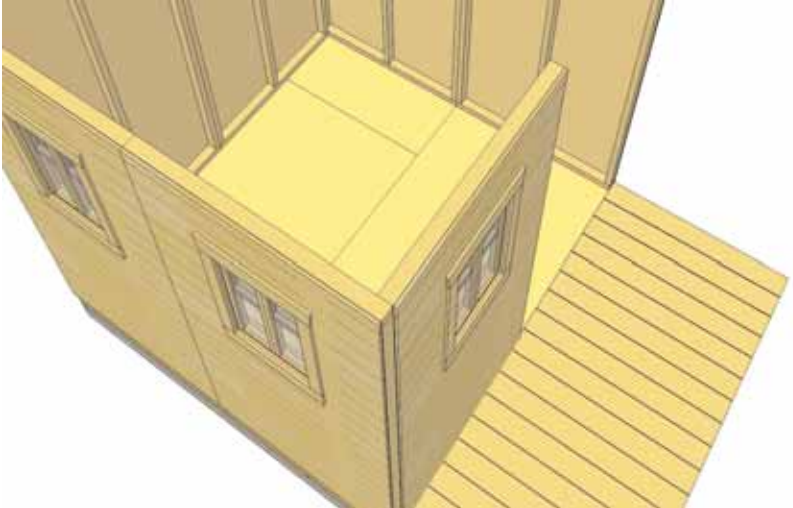
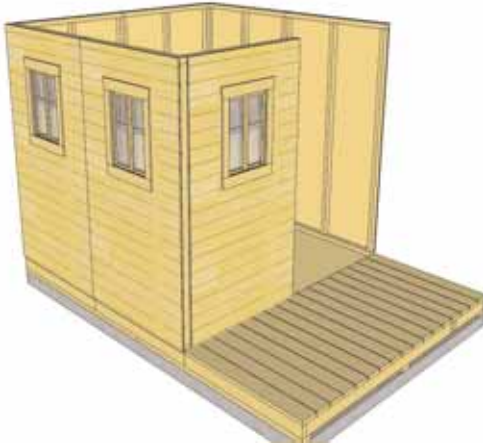

19. When attaching front corner wall panel, make sure panel is nested inside the side panel. Line wall framing and secure at top, middle and bottom of wall studs.

narrow wall

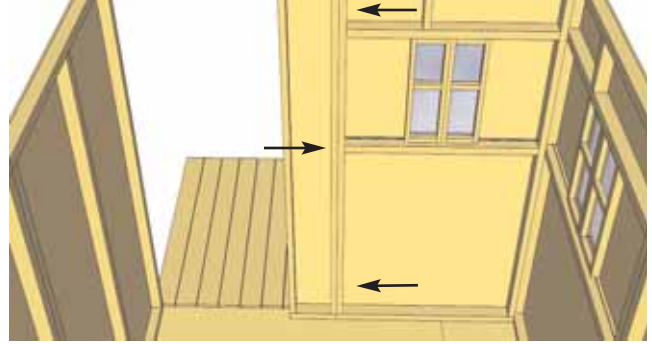
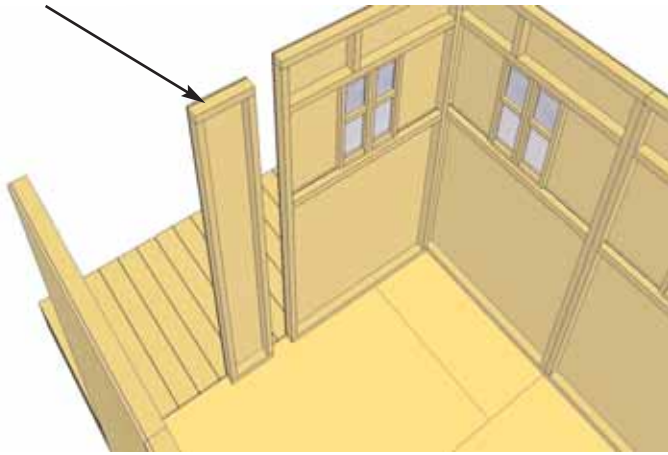

20. To complete walls, attach the Narrow Porch Wall to front wall panel. Note, the narrow wall is only 73" high. Attach wall stud to adjoining wall with 3 - 2 1/2" screws.

Door Header with Dado to outside

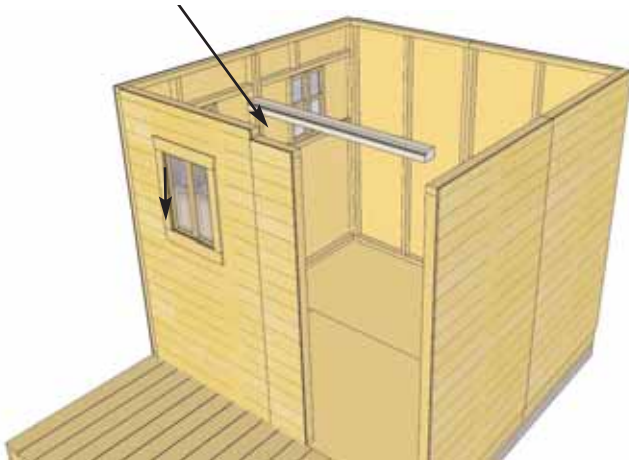

Header to be attached to Door Jamb in **Step 21.**

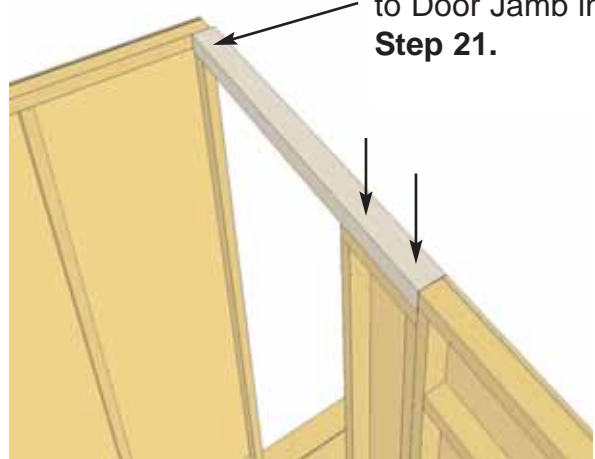

21. Attach Door Header to top of Narrow wall so Header is flush with framing on inside. Use 2 - 2 1/2" screws to secure. Next, attach Door Jamb to right side wall stud. Align the Jamb so Door Header sits directly on top. When in correct position, secure to wall stud with 4 - 2 1/2" screws. When positioned correctly, the Jamb will overhang the right side wall panel framing by 1/2". Secure Header to Jamb with 2 - 2 1/2" screws.

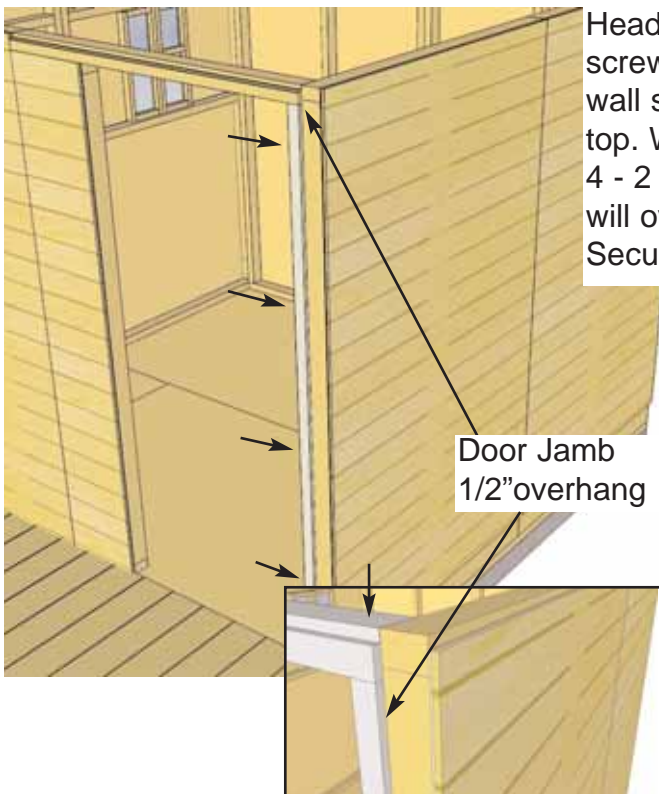

Door Jamb
1/2" overhang

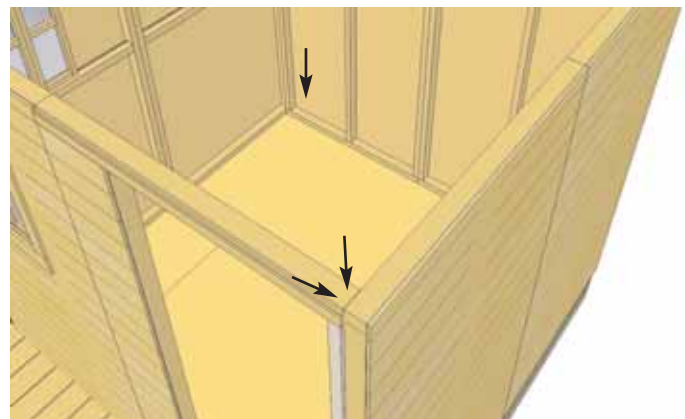

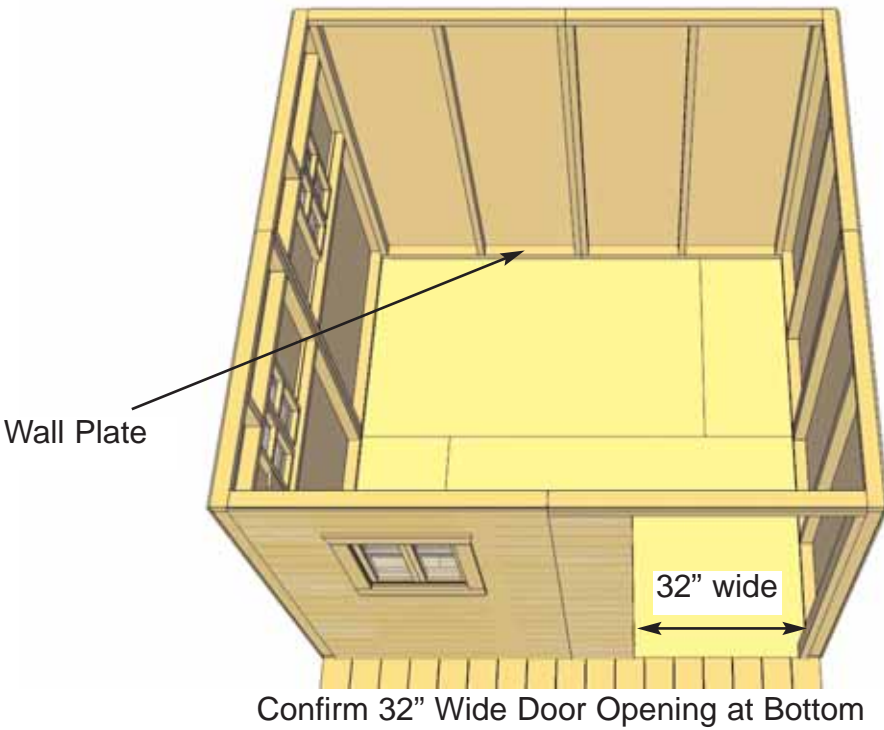

22. When all walls are attached together, check alignment with the floor. Bottom wall plates should sit flush with outside of plywood floor. When positioned correctly, fasten bottom wall plates to floor using 4 -2 1/2" screws per wall panel.

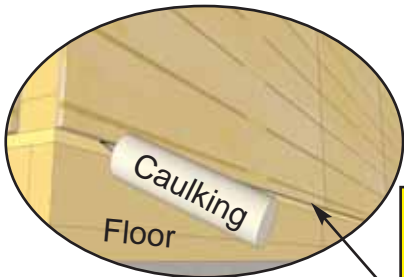

Optional - Caulking seams will help prevent moisture from entering at seam. **Caulking not included in kit.**

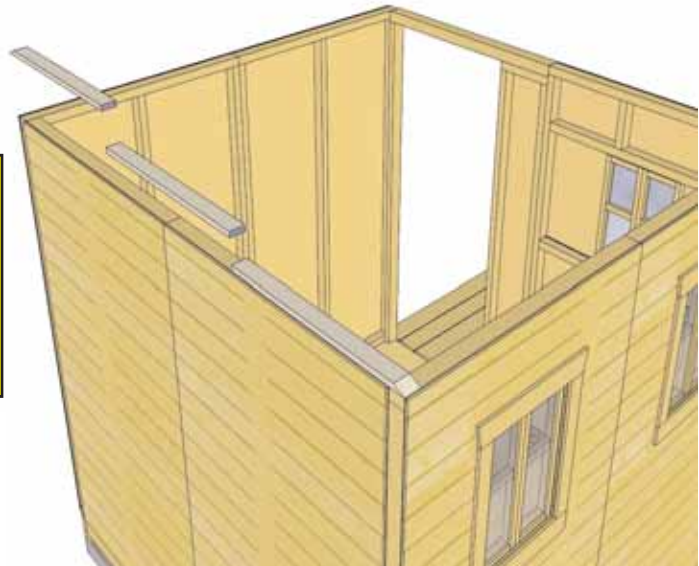

23. Position angle cut **Rear Top Plates** on top of wall studs so they are flush on the inside with 2x3 wall stud. The Top Plate is comprised of 3 pieces (2 outside pieces with an angle cut on one end and a center piece that is straight cut). Attach by screwing down into top wall plate with 4 -2" screws.

Angle cut on ends.

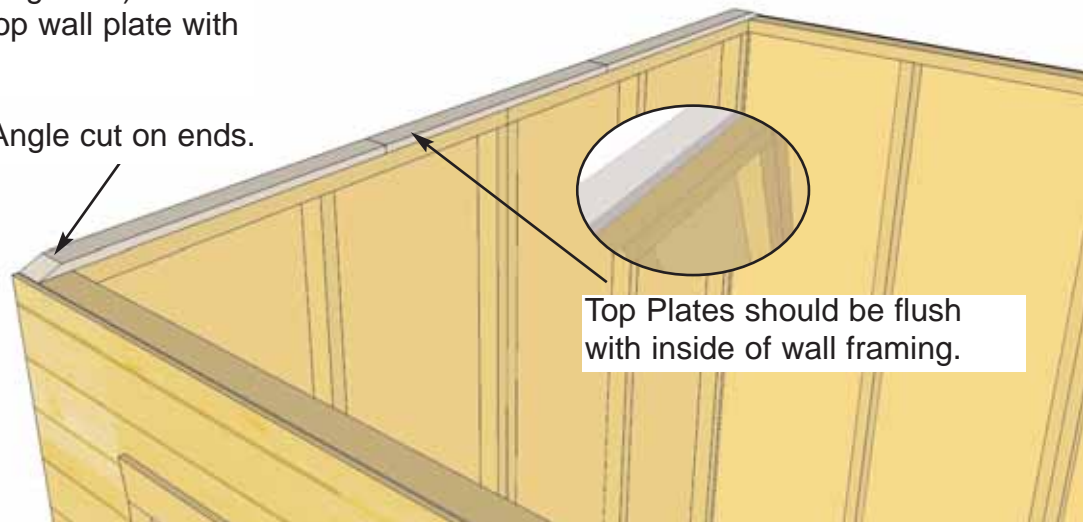

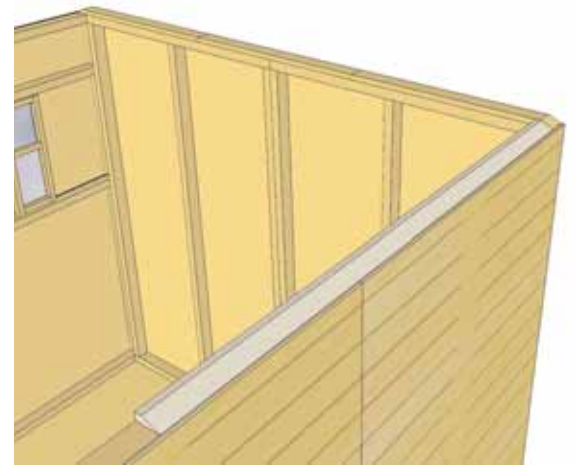
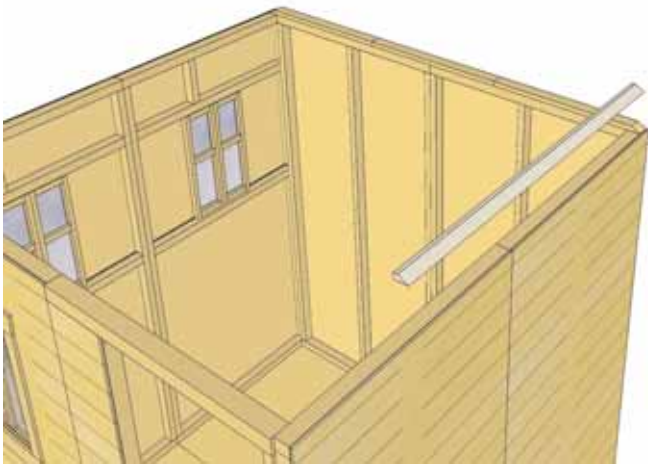

24. Next, attach the 4 Side Top Plates (2 per side). The side top plates are angle cut down the length. Once again, position top plate on wall plate so it is flush with inside of wall plate. Side plate should also be flush with rear wall plate. Secure with 4 - 2" screws per piece.

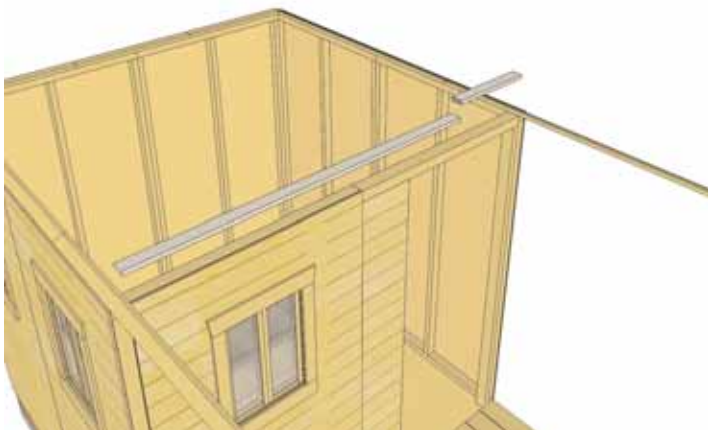
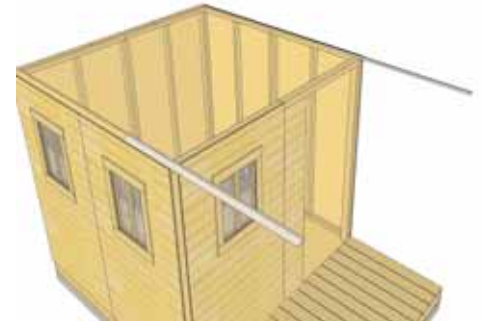

25. Position the Front Top Plates on top of Door Header and front wall panel. There are 2 plates (72" and 19" long). Front top plates are straight cut on the ends. Once again, the plate will be flush with inside of top wall framing. Attach with 6 - 2" screws in each plate. (4 screws in long and 2 in short plate).

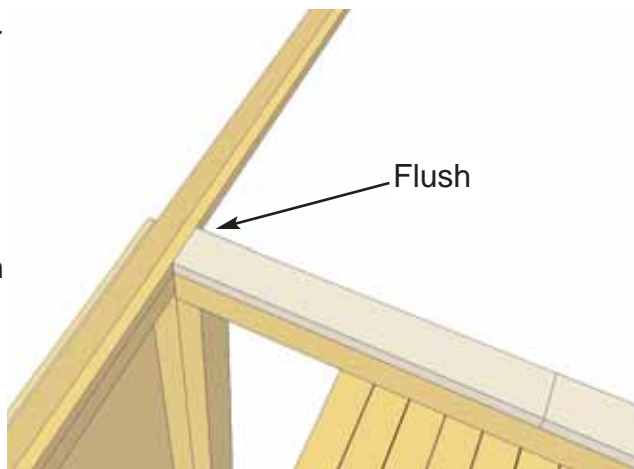

26. Complete all side top plate attachments as described above.

Caution: Prior to completing **Step 29**, side top plates will be protruding out from the shed, please use caution in the work area.

27. To complete the Porch Rail Section, the porch sections must be assembled on level ground first. There are 2 sections.

A. Attach 1x4 **Top Plate Front Extension (34 1/2" L)** to 4x4 Porch Post with 2 - 1 1/2" screws. Make sure support is flush with post.

B. Attach 1x4 1/2" **Wall Trim/ Supports** to Front Extension using 2 - 1 1/2" screws. Make sure Front Extension is Flush to back of wall trim and centered 1/2" on each side. Note: there are 2 different wall supports for left & right.

C. Attach both **Corner Brackets** with 3 - 1 1/2" screws from Front Extensions into Brackets. Attach Brackets to Porch posts. Drill Pilot hole in bracket first.

D. Attach **Hand Rail** to complete your Porch Rail Section. Handrail should start 4" from bottom of Post and be centered on Post. On Wall trim side, handrail should sit approx. 1 1/2" in from outside of Wall trim. Use 3 - 1 1/2" screws to attach.

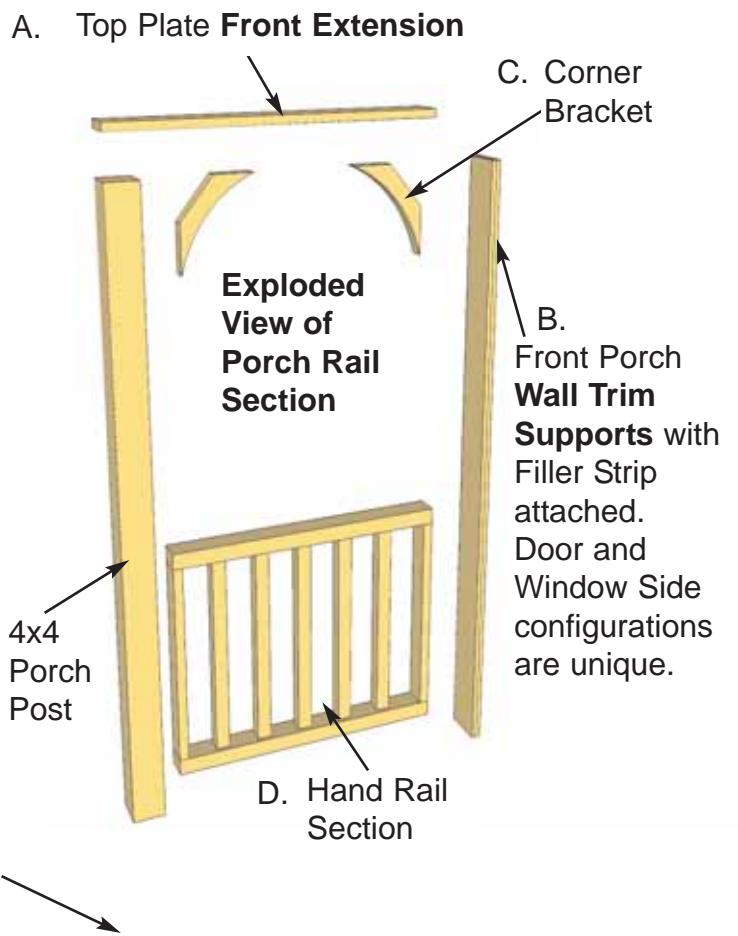

Important: Drill Pilot Holes to prevent wood from splitting!

Door Way Side
4 1/2" Filler Strip on rear of Wall Trim Support.

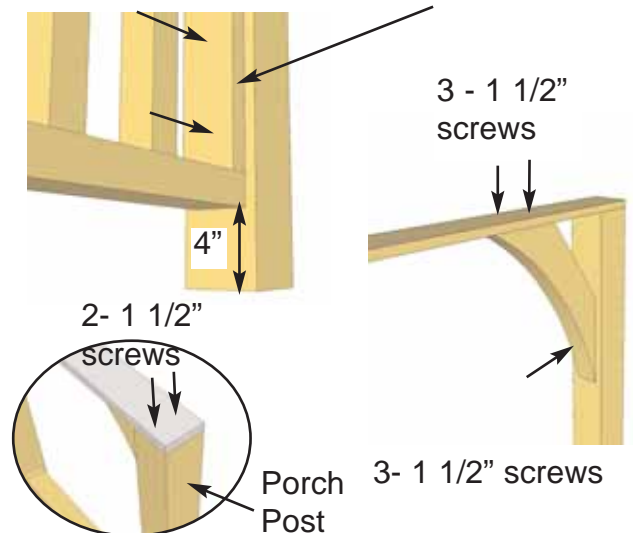
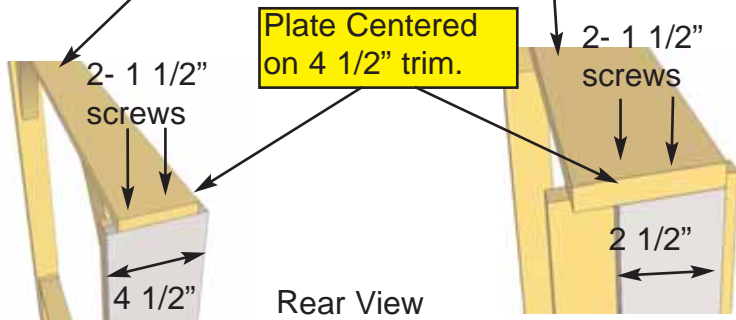
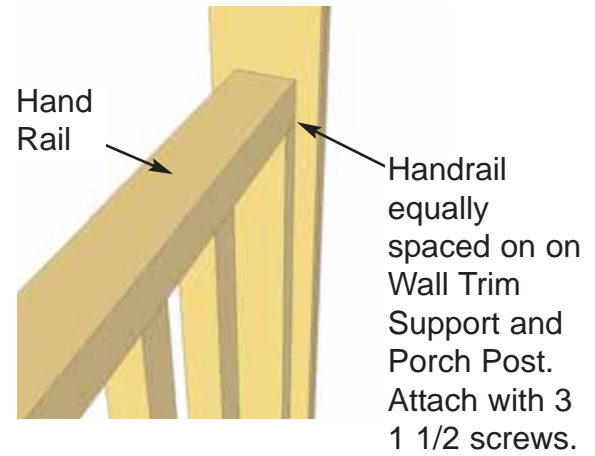
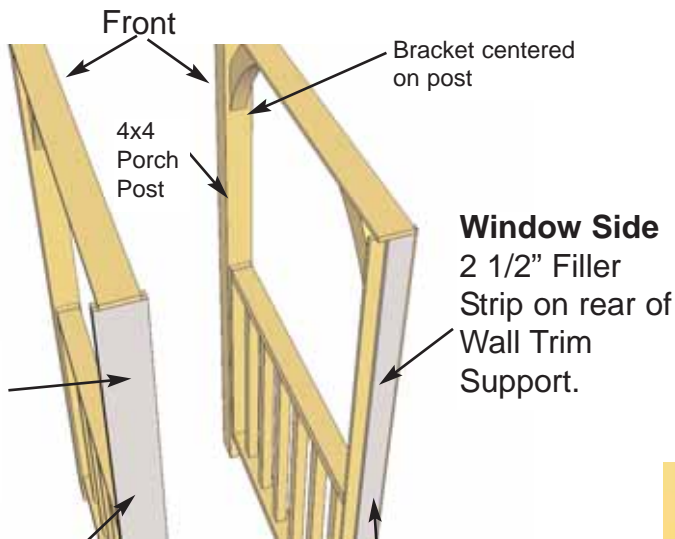

28. When both porch sections are completed, lift Right Side Section into place on deck beneath the side top plate. **(Make sure to use the correct right/left side configuration.)**

Attach Wall Trim/ Support to wall with 3- 2 1/2" screws. Try to conceal screws if possible. Screw Side Top Plate into Front Extension of Porch section with 3 - 1 1/4" screws. Screw into corner brackets and post to conceal screws.

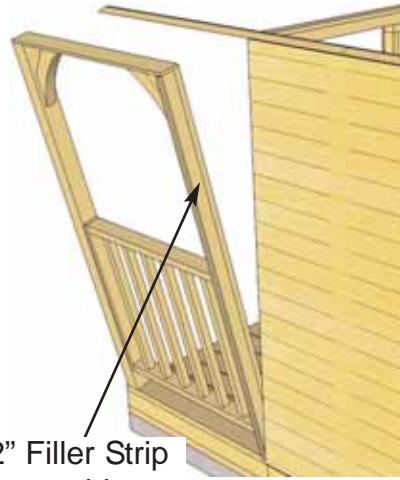

4 1/2" Filler Strip Doorway side.

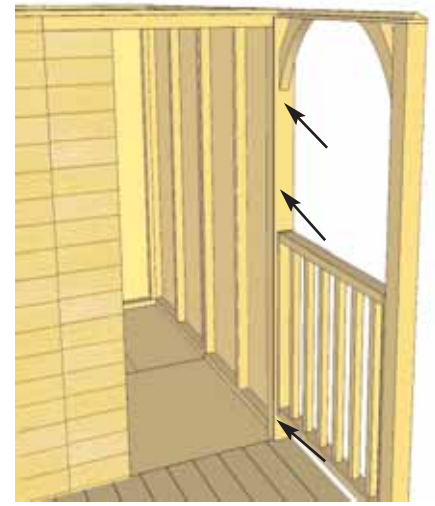

29. Align Porch Post so flush with outside of decking. Secure post to deck by toe-nailing with 3 - 2 1/2" screws. Note, drill pilot holes to prevent post from splitting.

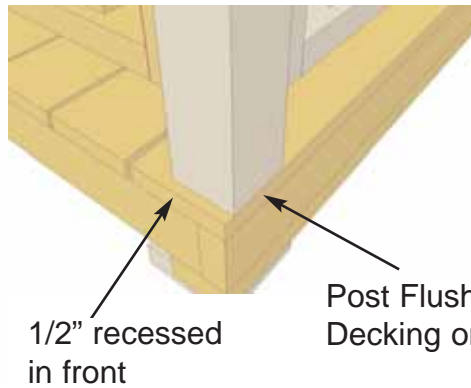
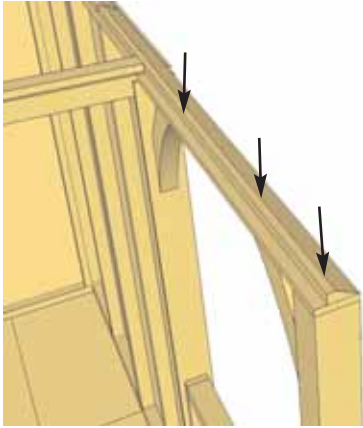

1/2" recessed in front

Post Flush with Decking on side

30. Complete Left Side Porch Section as per **Step 28 & 29.**



Important: Hinge not exactly as shown.

Door Trim edge

2" Screws

Center Hinges

3/4" screw

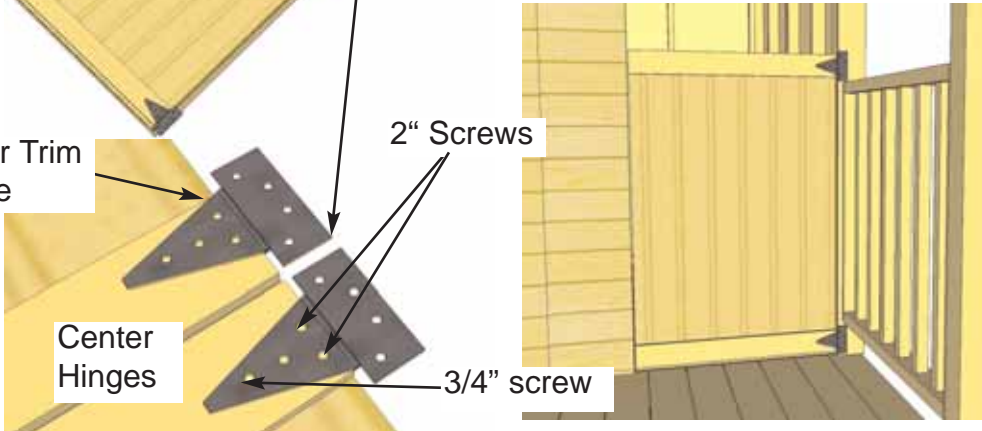

1/2" gap

31. Locate the Bottom and Top Sections of the Dutch Door. The Bottom Section is larger than the Top Section. Attach 2 Hinges to each section. Center Hinges should be positioned to edge of door trim to prevent hinges from contacting each other. Use 2" & 3/4" black screws on hinge / door attachment as shown above. Be careful not to strip screws when tightening. Attach Hinge on the door's horizontal trim. Position the Bottom Door in place. Use a 1/2" high spacer for the bottom and 3/8" on the left and 1/8" on the right. When in correct position, attach hinges to Wall Trim / Supports with 3 - 2" Black screws. (use only 1 Black 2" screw until door has been correctly aligned, then complete remaining 2 screws)

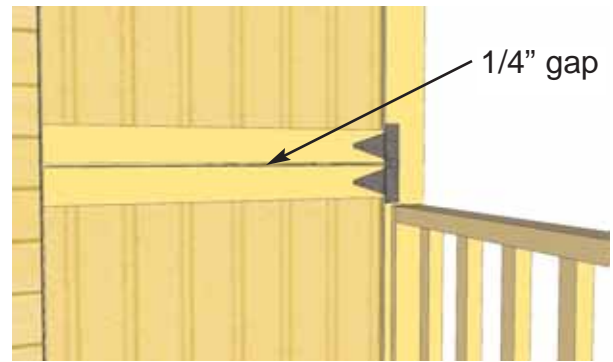

32. Align Top Door and space as per Bottom Door on sides. Leave a 1/4" gap between the Bottom and Top Door. When in correct position, secure hinges to Wall Trim/ Support as per previous step.

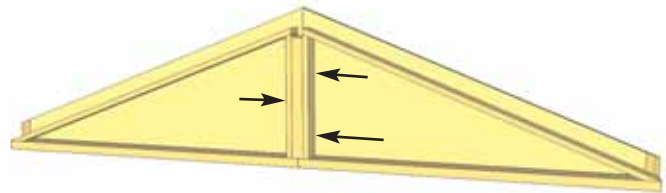
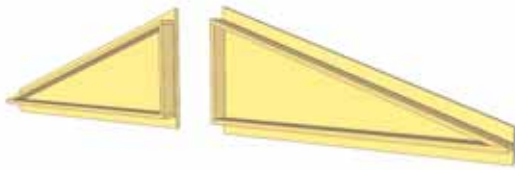

33. Locate both Rear Gable Wall pieces. Rear Gables have shingles that overhang the top and bottom of the gable frame. Screw together with 3 - 2 1/2" screws.



See **Step 65** for explanation of what is an exposure line.



34. From the outside, slide in a Rear Gable Wall Filler Shingle to cover gable seam. Nail down above the exposure line with 2 - 1 1/2" shingle nails.

35. Complete by attaching top precut Filler Shingle with 2 shingle nails.

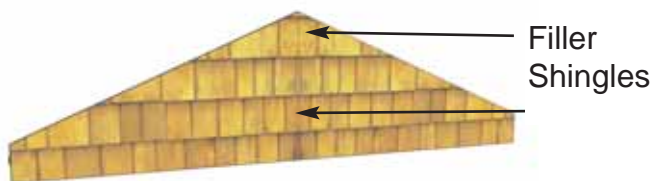

36. Lift up the rear completed gable section and place on top of rear walls.



37. Position the **Rear Gable Wall** on top of the Rear Top Plate.

The rear gable framing should sit flush with the inside of the top plate. It should also be centered sideways on the top plate.

Hint: use a square to check the angle of the gable framing and top plate. Both angles should line up. Adjust gable accordingly. Temporarily attach to walls and Top Plate with 2 - 2" screws. Gables may need slight adjustment in **Step 51**. Complete attachment in **Step 51** and additional 6 - 2" screws. Screw from the bottom of gable framing down into Top Plate and Wall.

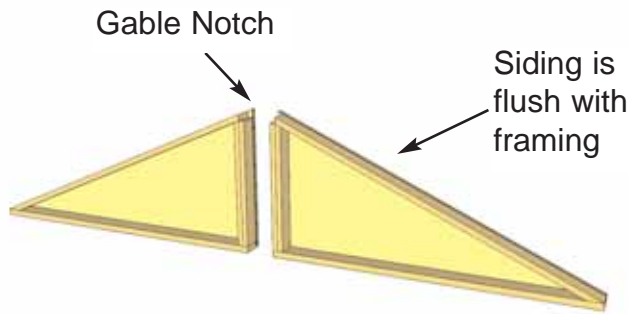
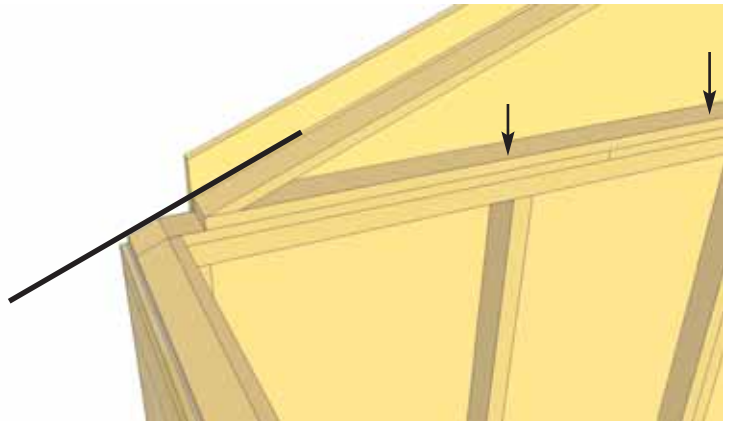

38. Locate both Middle Gable Walls and attach together as per **Step 33**.

39. Position the **Middle Gable Wall** on top of front top plate. Middle gable has cedar siding on the front that is cut flush with gable framing. Once again, the framing of the gable should be flush with outside of plate and be centered sideways on the plate.

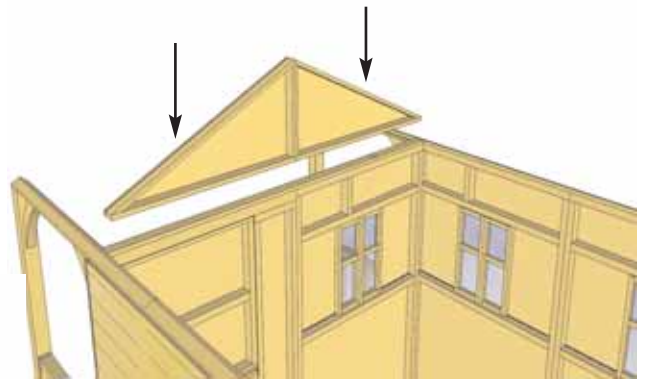

When in correct position, attach with 2 -2" temporary screws as per **Step 37**. Later in **Step 51**, complete attachment after Gables are correctly aligned with 6 more 2" screws.

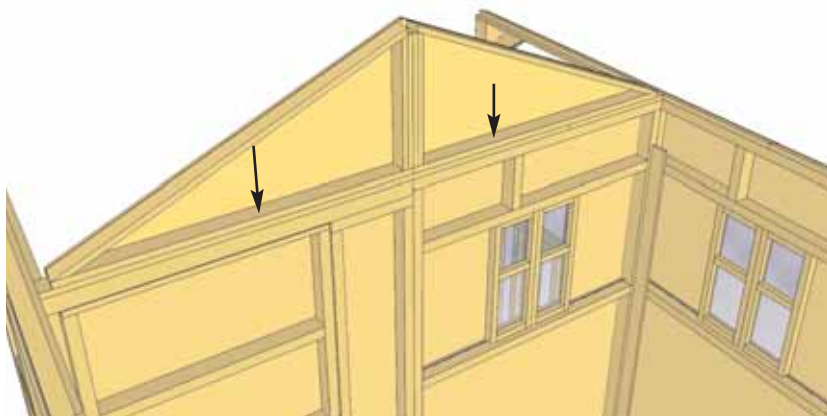

C. & D. Rafter and Roof Section

Exploded view of all parts necessary to complete the Roof Section.
Identify all parts prior to starting. (Roof Filler Shingles Missing)

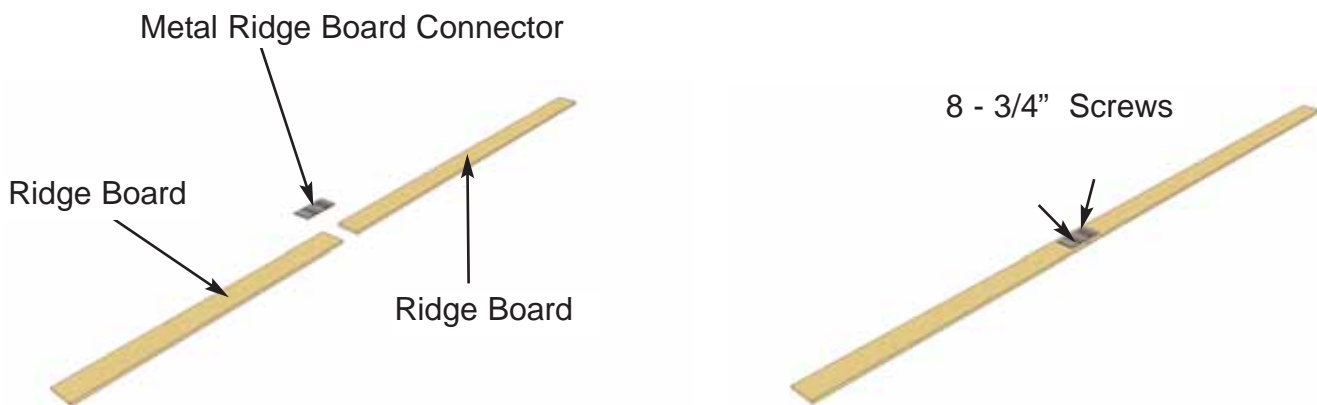
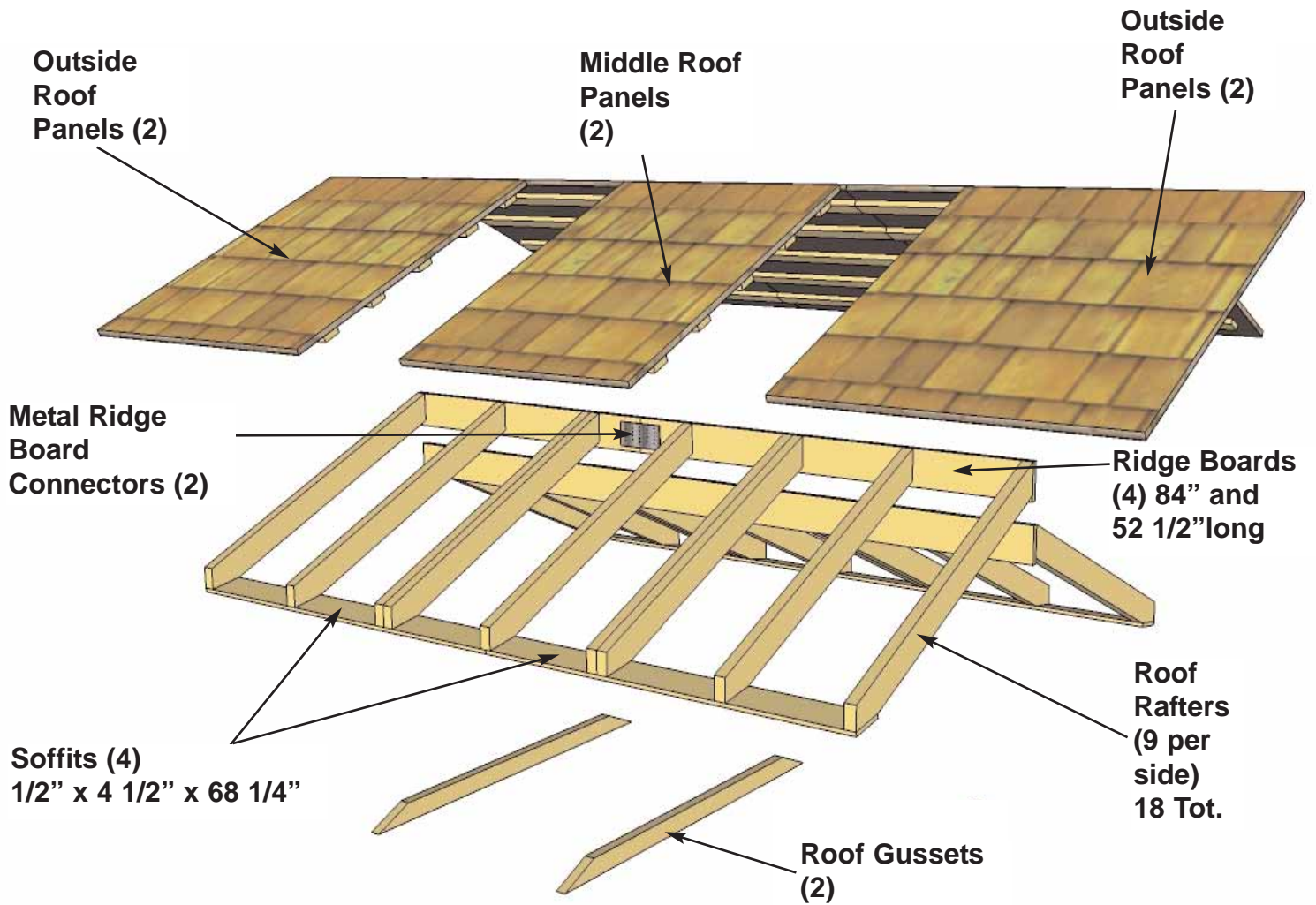

40. Locate (1 each) 3/4" x 4 1/2" x 84" & 52 1/2" Ridge Boards and attach together with Metal Ridge Board Connector using 8 - 3/4" silver screws. Total Length when connected is 136 1/2". Complete two Sets. Position Metal Ridge Board Connector evenly on Ridge Boards.

41. Locate 9 **Rafters**, 2 **Soffits** and completed Ridge Board. Lay out on level ground as shown to the right. Double up Rafters as illustrated. Screw doubled up Rafters together with 3 - 2 1/2" screws per piece.

Note, completed rafter section will be flipped over in **Step 44**.

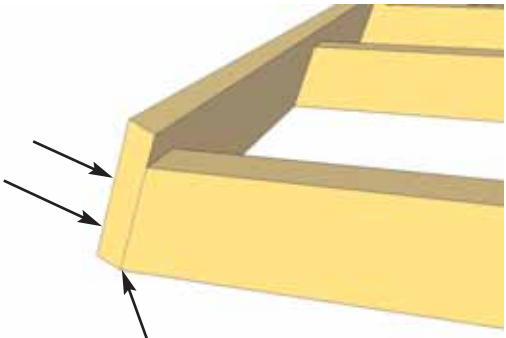
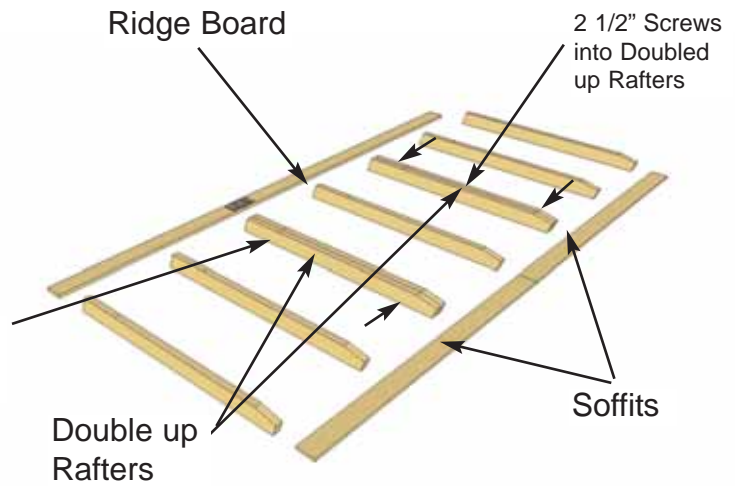

42. Attach completed Ridge Board to ends of both outside rafters with 2 - 2" screws per end. Measure and position interior Rafters as illustrated below. When positioned correctly, attach Ridge Board to remaining rafters with 2 - 2" screws /rafter end.

Important: Pilot Hole Ridge Board to prevent splitting!

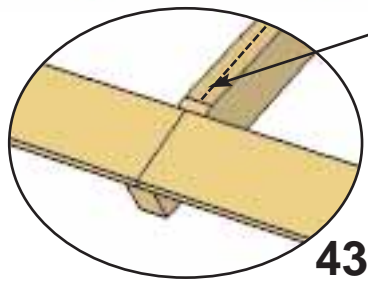
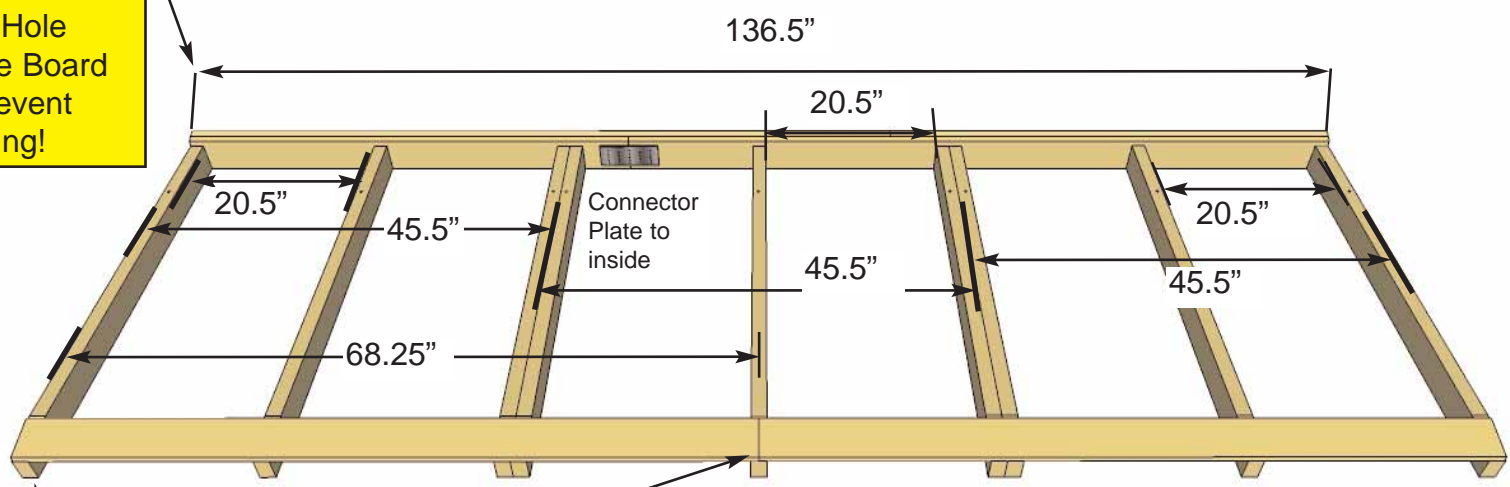

Flip Rafter Sections over when complete

Important: Pilot Hole Soffit to prevent splitting!

43. Attach end of a 68 1/4" long Soffit Board flush to ends of outside rafters with 2 - 1 1/4" screws per rafter end. Drill pilot hole in Soffit ends to prevent splitting. Complete both outside rafter / Soffit connections first. Measure and position interior Rafters as illustrated above. When positioned correctly, attach Soffits to remaining rafters with 2 - 1 1/4" screws /rafter.

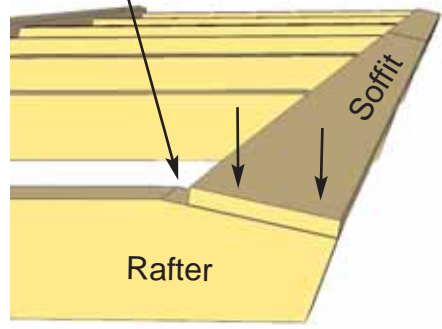

Flip completed rafter section over. Complete 2nd Rafter section now as per **Steps 41 - 43** with the following exception.

When attaching Ridge Board to Rafter ends, make sure Metal Ridge Board Connector is positioned so offset to first Rafter Section. See Step 50 for illustration.

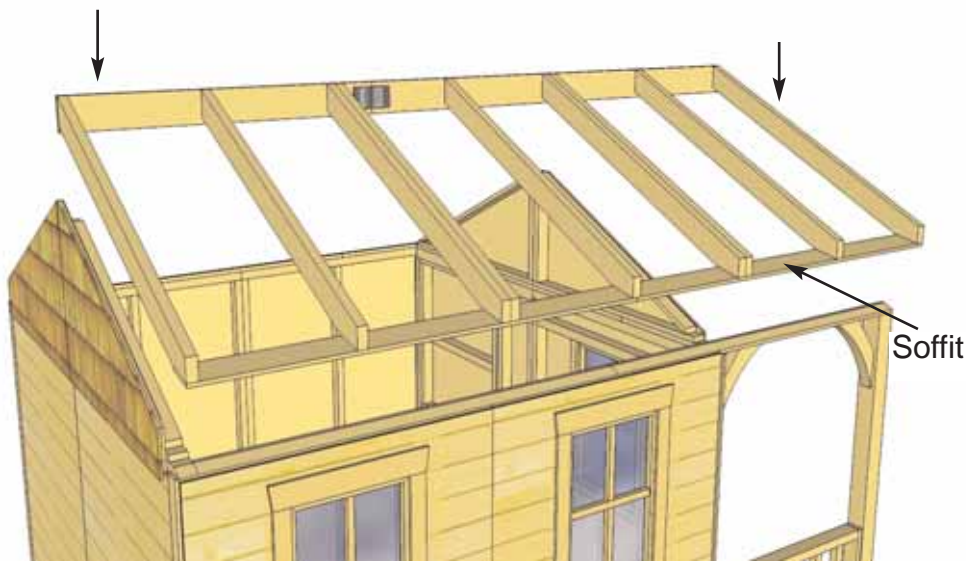

44. Carefully lift 1 completed Rafter Section up. (make sure Soffit is facing down) and place on gable framing.

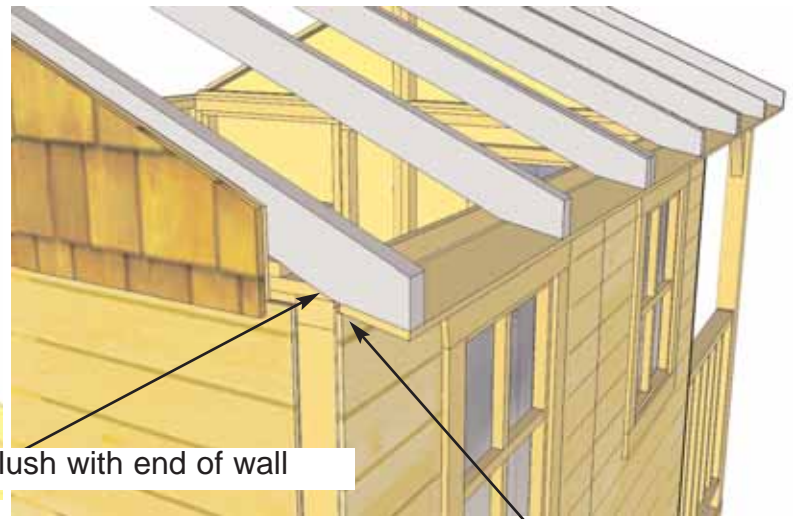
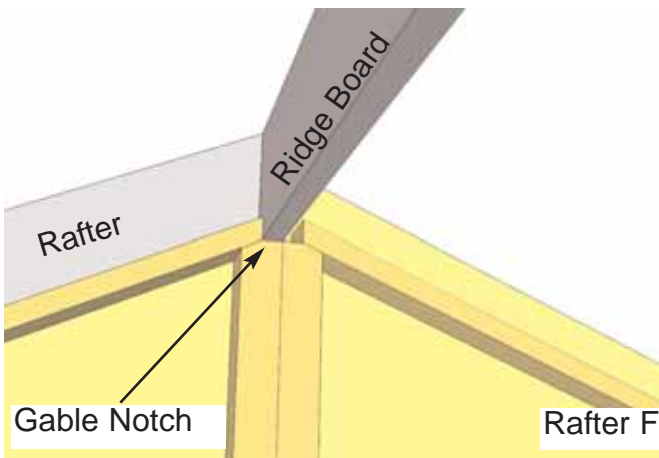

45. Slide Rafter Section up on gable framing until bottom of Ridge Board slips into gable notch. Soffit will sit approximately 1/8" away from wall panel.

Soffit should sit approx. 1/8" away from wall panel. End Rafter will sit flush with end of wall.

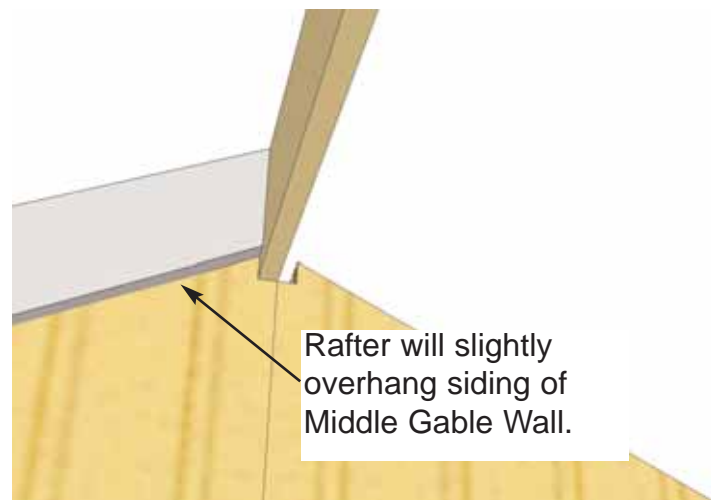
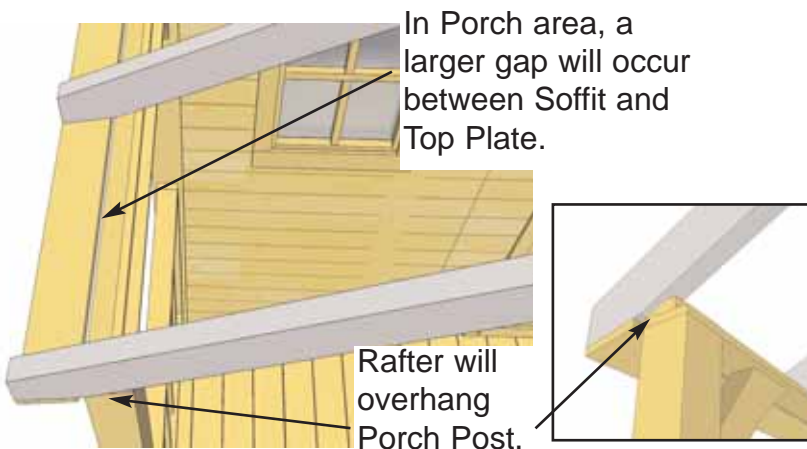

46. To confirm Rafter Section alignment, in the front, Rafter will overhang Porch post by approximately 1/2". Rafter will also overhang the siding of Middle Gable Wall.

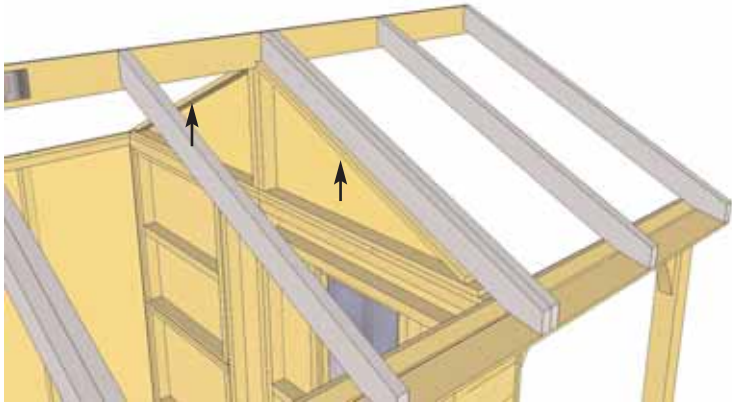

47. When Rafter Section is aligned correctly, tack Rafter Section temporarily down from Middle Gable Wall framing into Rafter with 2 - 2" screws.

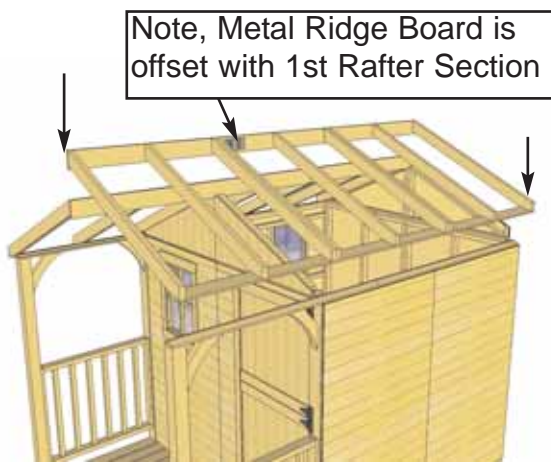

48. Place 2nd completed Rafter Section on gable wall framing. Position as per **Steps 45 & 47.**

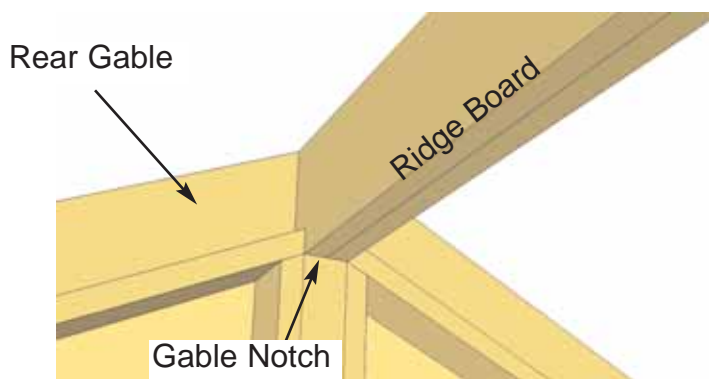

49. When both Rafters Section are correctly aligned, Ridge Boards will sit in both the rear and middle gable notches. Front Rafters will overhang Porch Posts.

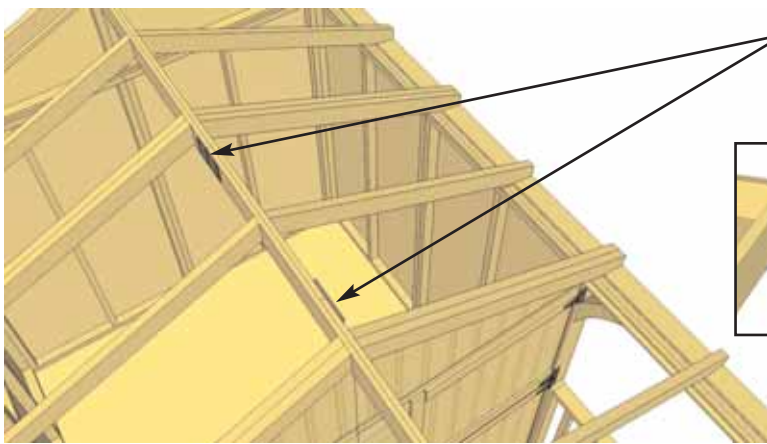

Offsetting Metal Ridge Board Connectors

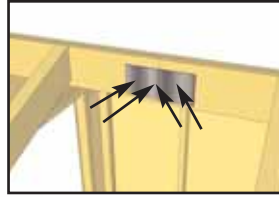

Important: Make sure Metal Ridge Board Connectors are offset to one another as illustrated to the left.

50. At the peak, align Ridge Boards so they are flush together and secure them with 12 - 1 1/4" screws. **Important-** if there is a gap between Ridge Boards, try pushing side walls closer together from outside. Walls should be 91" apart at top from inside of wall plate to wall plate. To completely secure Ridge Boards, place 4 - 1 1/4" screws into any of the remaining Metal Ridge Board Connectors holes. Complete both sides.

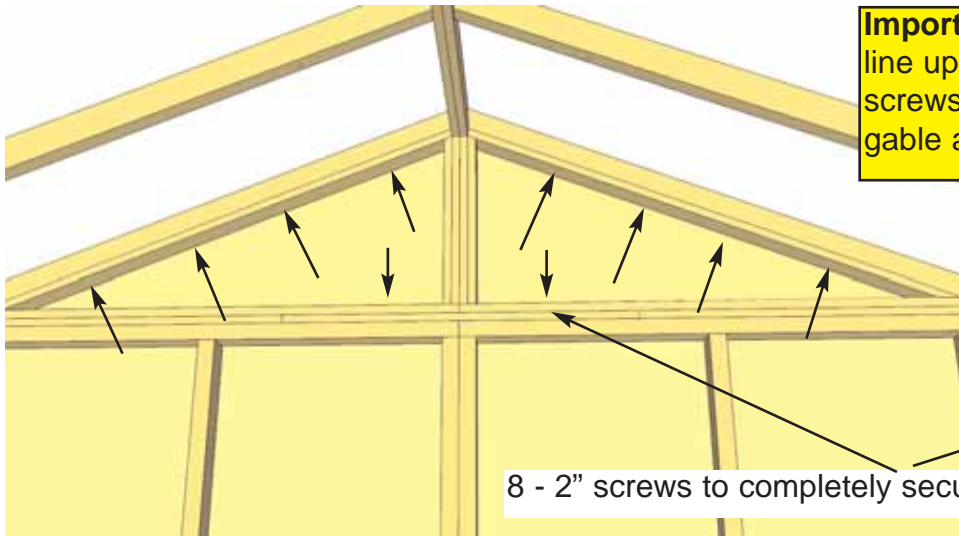
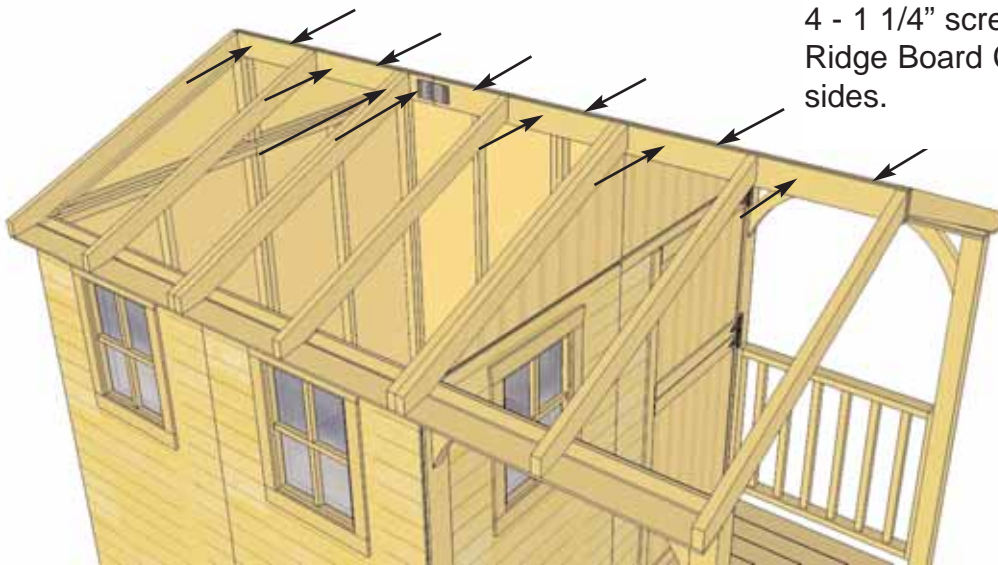

Important: - If Gable framing does not line up with Rafters, remove temporary 2" screws from gable framing. Re-align gable and secure with 8 - 2" screws total.

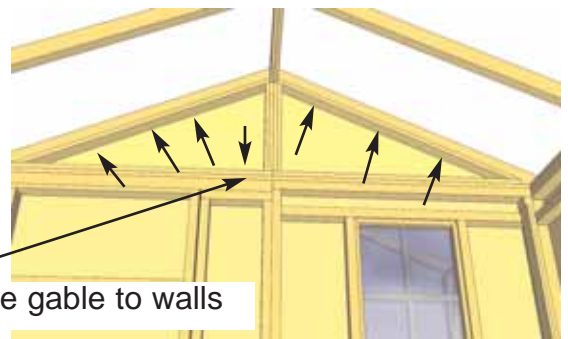

8 - 2" screws to completely secure gable to walls

51. With both Rafter Ridge Boards connected, completely secure Rafters to Gable framing of both rear and middle Gable Walls. Use 8 - 2" screws per gable.

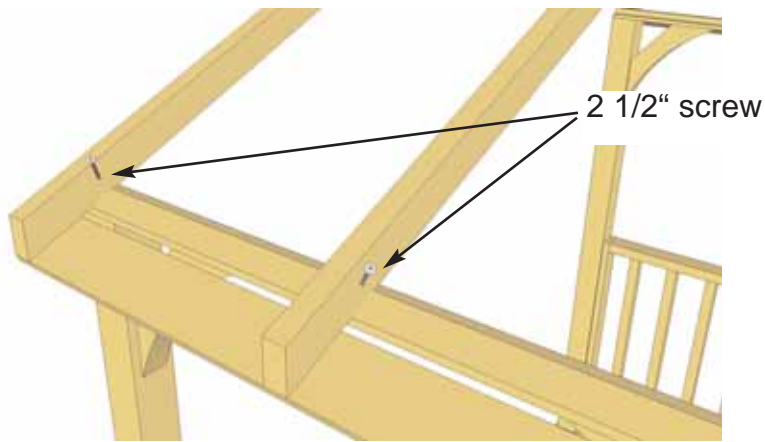

52. Attach Rafters in porch area into Top Plate of porch with 1 - 2 1/2" screw per Rafter. Once again, measure 91" from inside of wall plate to wall plate for correct Rafter alignment prior to attaching. Drill pilot holes in rafters on angle first to prevent splitting and then screw down.

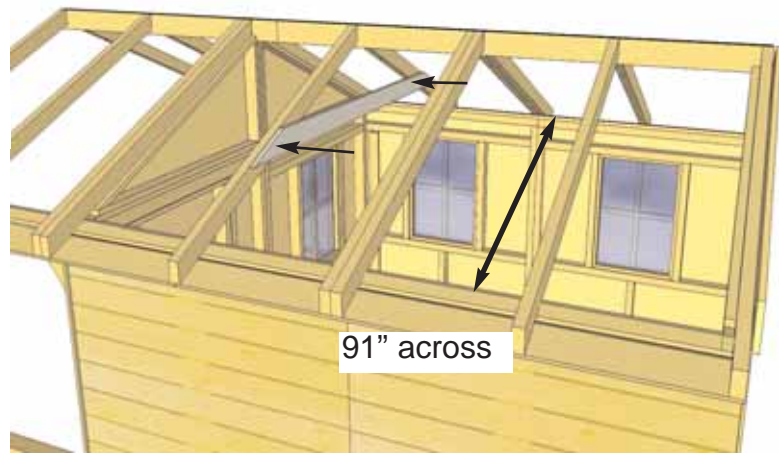

53. **Roof Gussets** are positioned on middle rafters. Prior to attaching, make sure walls are properly aligned. Have two helpers push walls at the top from the outside of shed until inside to inside measurement between front and rear plates is 91".

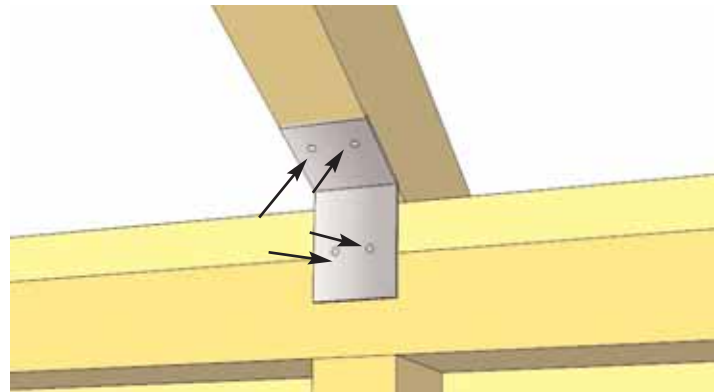
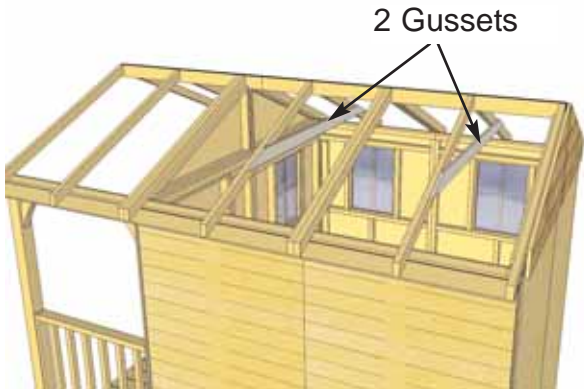

54. Slide gusset up, use level to square gusset and attach to rafters with 4 - 1 1/2" screws. Complete remaining Gusset. Locate **Simpson Strong Ties** with 22 degree angles (8) . Place underneath Rafter, flush against wall plate. Attach Tie with 4 - 1 1/4" screws to secure.

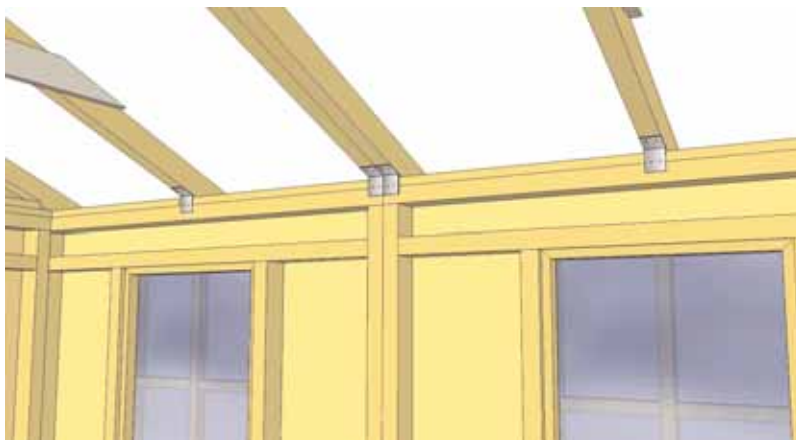

55. Complete attaching remaining Simpson Strong Ties to Top Wall framing and underside of the rafters. There are 4 Ties per side.

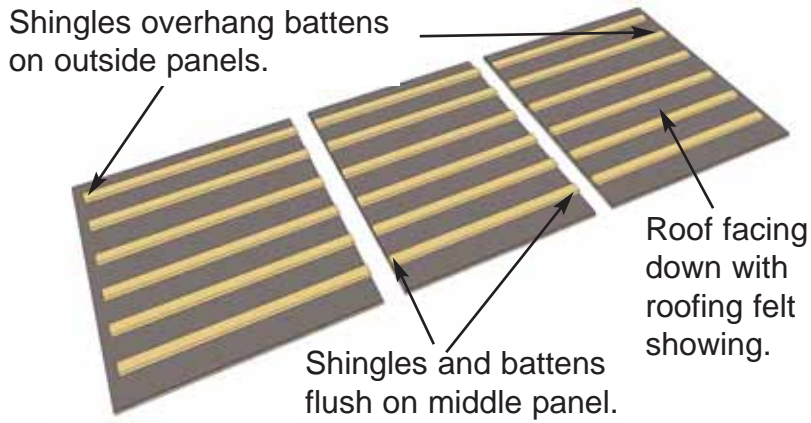

Outside Roof Panel with Shingles overhanging end.



56. Identify Roof Panels. There are 2 Outside and 1 Middle Roof Panel per side. Starting with outside rear panel, lift up and place on rafters.

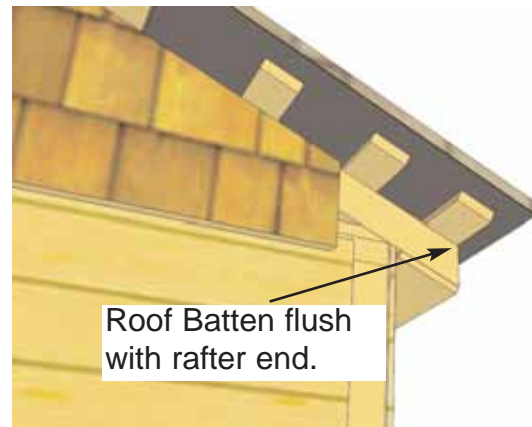
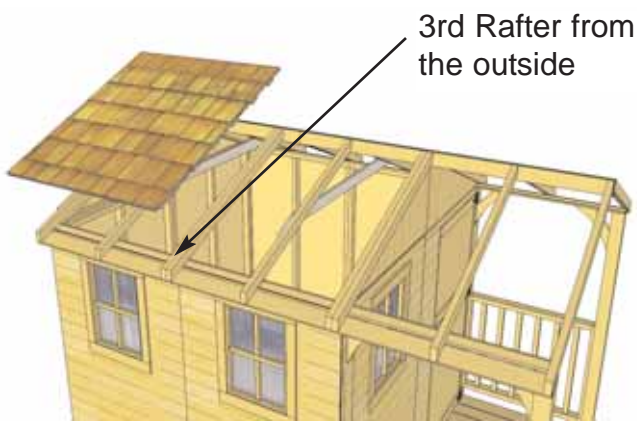

57. Place Outside Roof Panel so it sits flush on 3rd rafter from the outside (doubled up rafter). Lowest batten on roof should be flush with end of rafter at bottom.

Screw bottom row of shingle down to rafter with 1 - 2 1/2" screw.

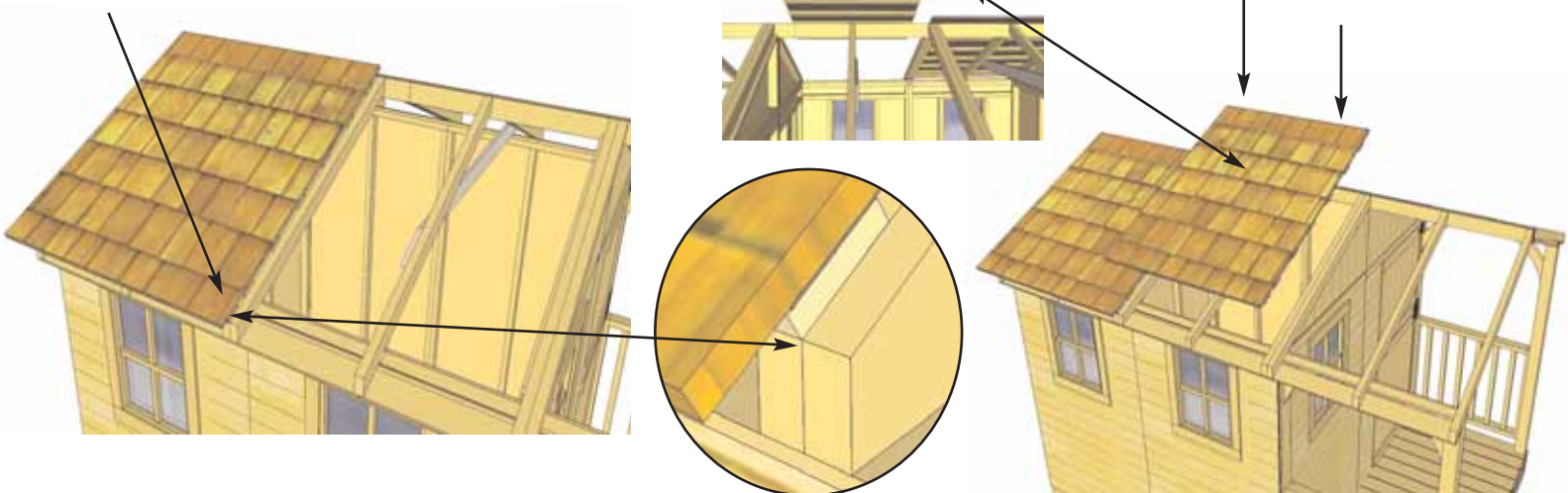

58. From the outside, screw down through bottom row of shingles into rafter with 1 - 2 1/2" screw. Locate Middle Roof Panel.(roof battens flush with outside of shingles) and place on middle rafters.



59. Aligned Middle Roof Panel as per **Step 58** and screw panel down to rafters with 2 - 2 1/2" screws in the bottom row of shingles. Lift up 2nd Outside Roof Panel on Rafters as per **Step 57**.

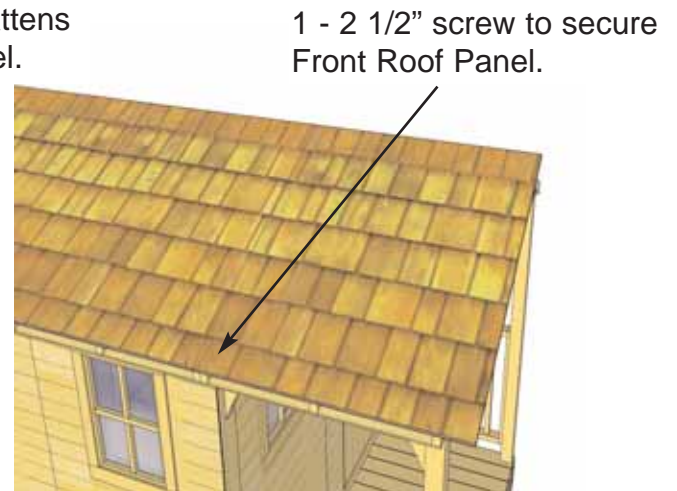
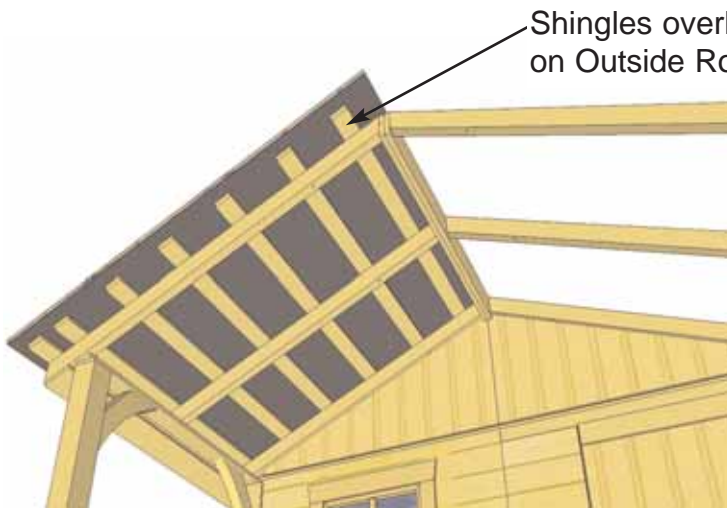

60. Position and attach 2nd Outside Roof Panel on Rafters as per **Step 58** using 1 - 2 1/2" screw.

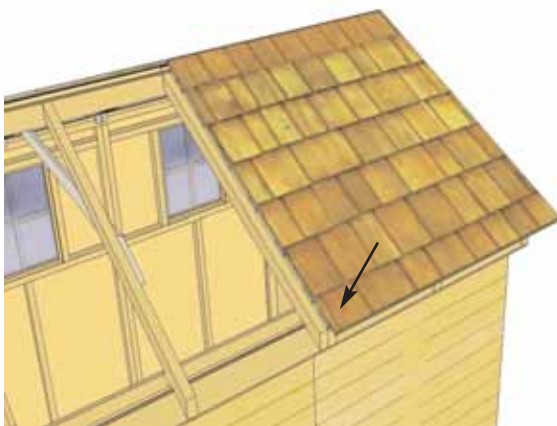

61. Lift up, position and attach right side Outside Rear Roof Panel on Rafters as per **Step 57-58**.

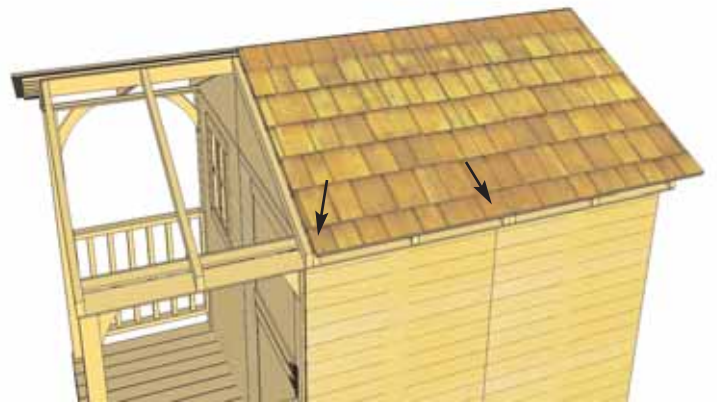

62. Lift up, position and attach right side Middle Roof Panel on Rafters as per **Step 58-59.**

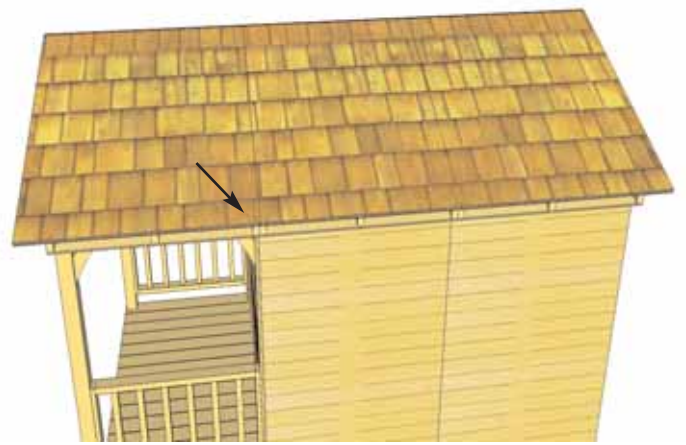
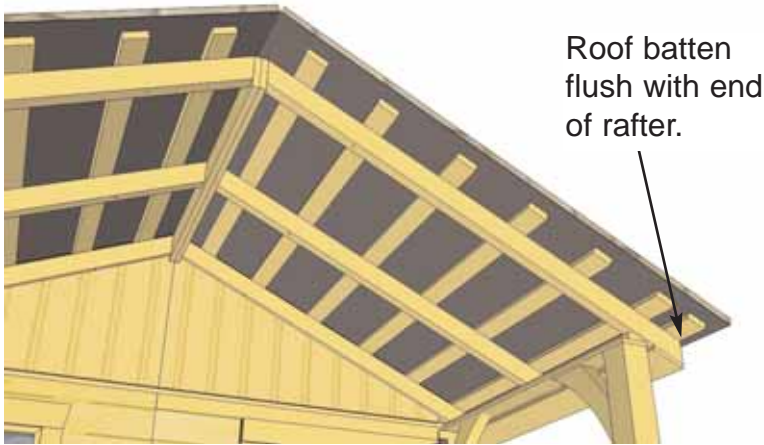

63. Lift up, position and attach right side Front Roof Panel on Rafters as per **Step 60.**

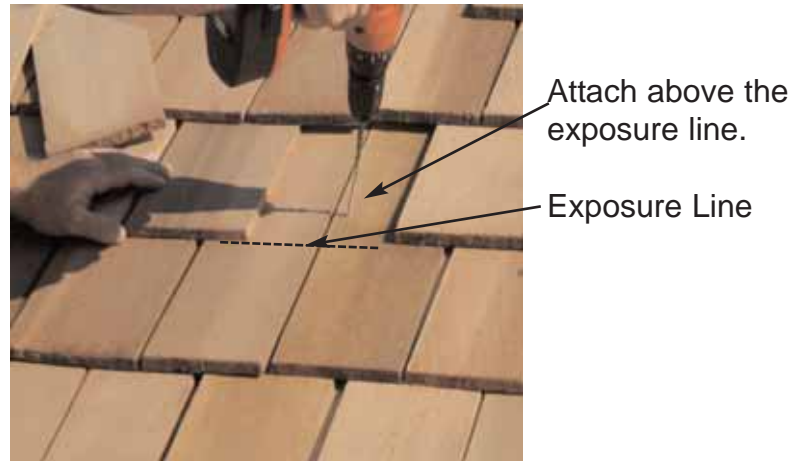

64. Roof **Filler Shingles** are included to cover roof seams. Starting at the bottom, slide the first Long Filler Shingle in until flush with other bottom shingles. **DO NOT ATTACH UNTIL STEP 65.**

65. Screw first filler shingle down to rafters using 1 - 2 1/2" screw per panel (2 in total). Make sure to screw into both rafter.



66. Slide in another Filler Shingle and attach as per **Step 65**. On your last row of shingles, the filler shingle is precut to fit properly. Attach to roof with 2 finishing nails per shingle.

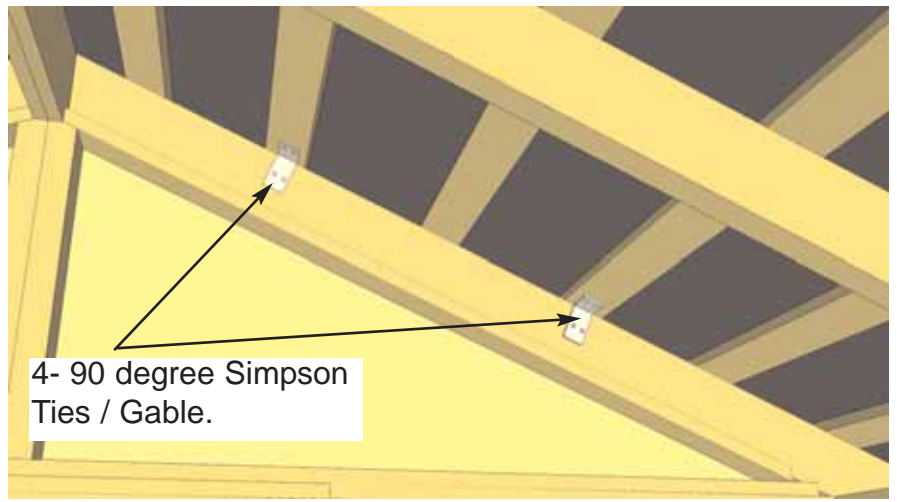

4- 90 degree Simpson Ties / Gable.

67. Position 2 Simpson Strong ties on battens and outside rafters and secure 4 - 1 1/4" screws. 8 ties in total.

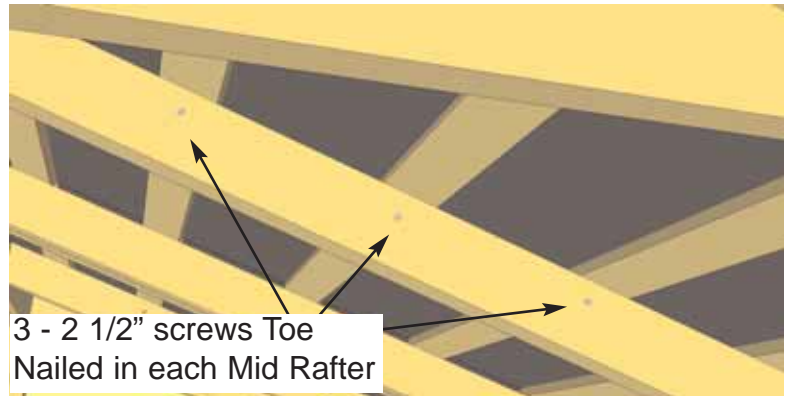
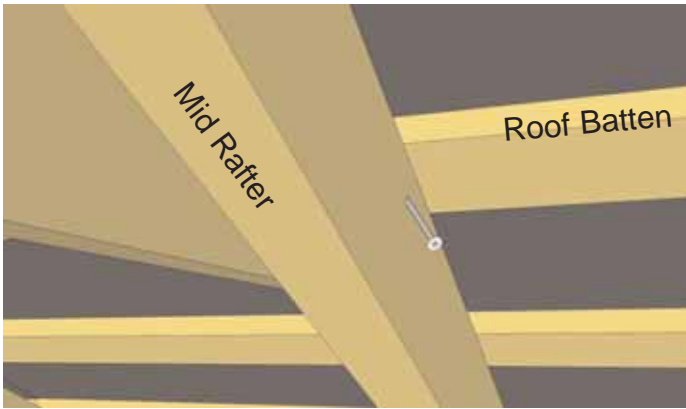

3 - 2 1/2" screws Toe Nailed in each Mid Rafter

68. To further secure roof panels, from the inside, drill pilot holes in each Mid Rafters (3 per Rafter) on an angle. Using 3 - 2 1/2" screws, secure rafters to roof battens. **Note**, from outside, push roof panel down so batten sit flush against rafter when securing. In Porch area, angle screw both the mid and outside rafters.

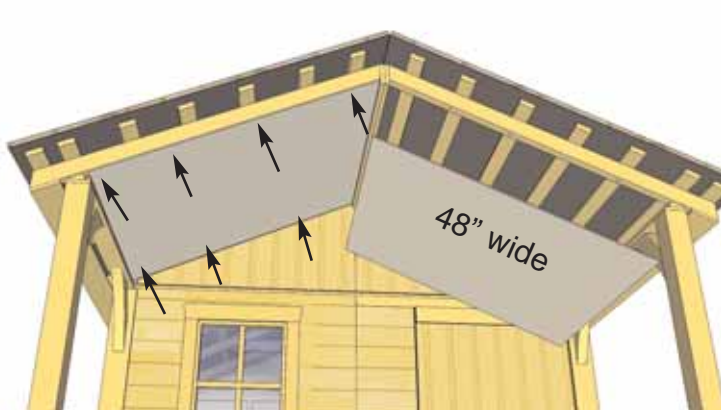

69. Position Porch Veneer with best face exposed, flush with front Rafter and Ridge Board. When correctly in place, nail veneer to rafters with 12 finishing nails. Complete both sides.

E. Miscellaneous Section

Exploded view of all parts necessary to complete the Miscellaneous Section. Identify all parts prior to starting.

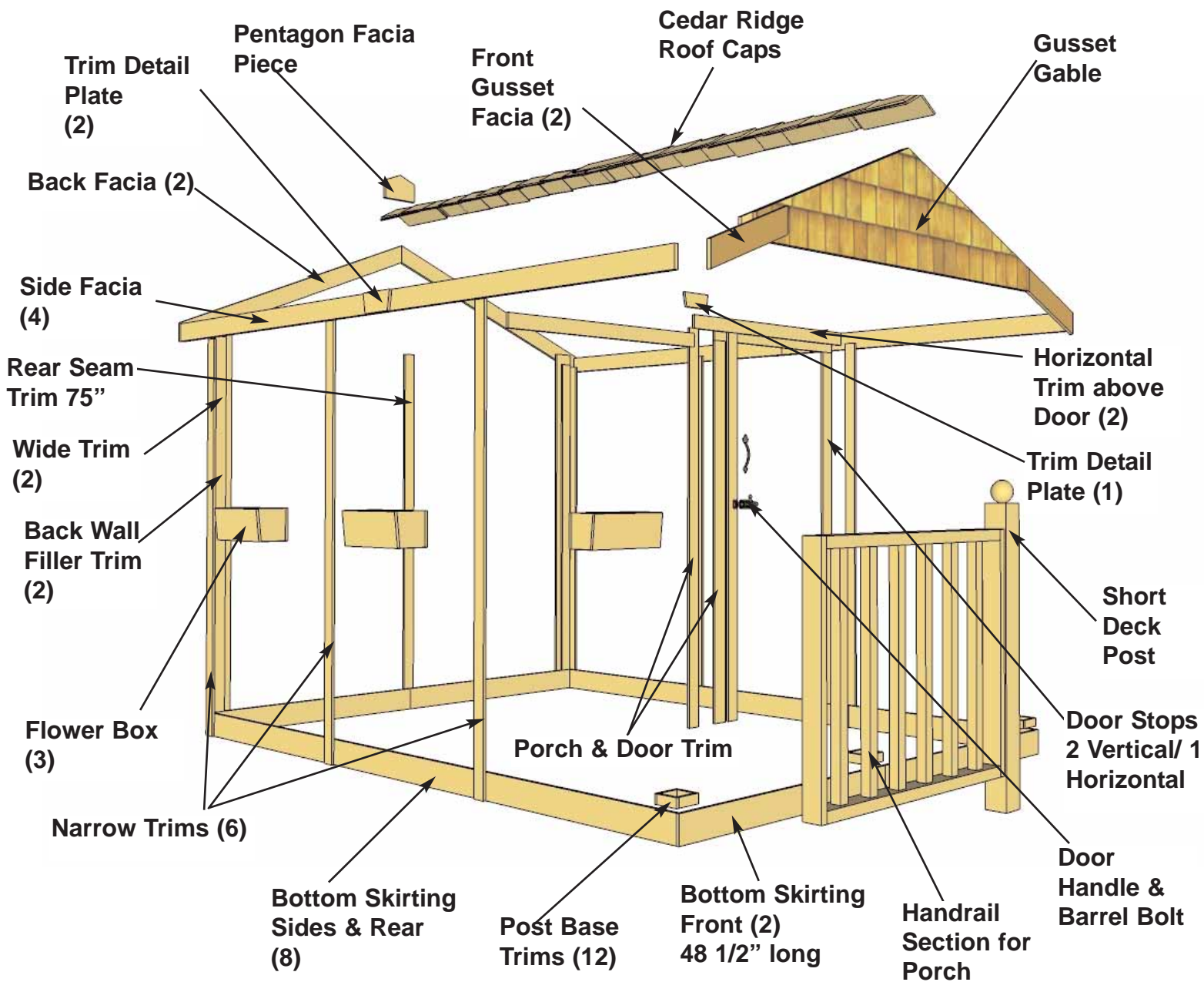

70. Attach **Bottom Skirting** around the base of the shed. Skirting will hide floor framing. The front skirting pieces will overlap the side skirting. Start with side skirting for porch. Attach with 4 - 1 1/4" finishing nails per piece. The skirting will sit flush with the outside deck board. The middle and end side skirting pieces will sit flush under siding of wall panel.

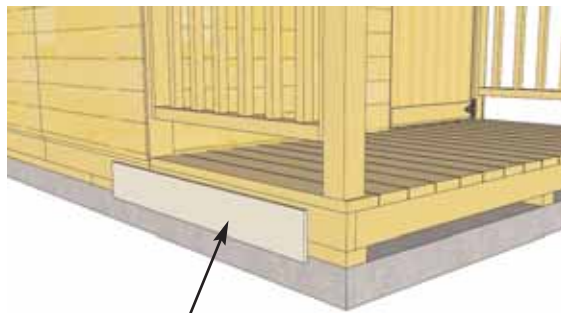

Side Skirting for Deck

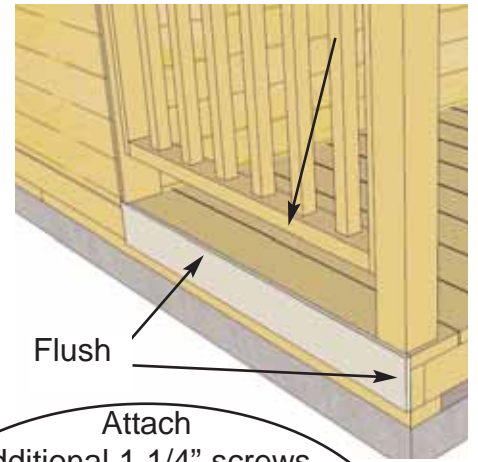

Flush

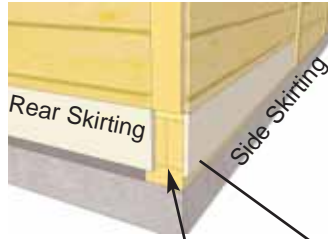

Gap at rear

3 pieces of Bottom Side Skirting per side.

Attach additional 1 1/4" screws on bottom edge of wall siding into bottom wall plate to further secure bottom siding to framing. Drill pilot holes in siding to prevent splitting.

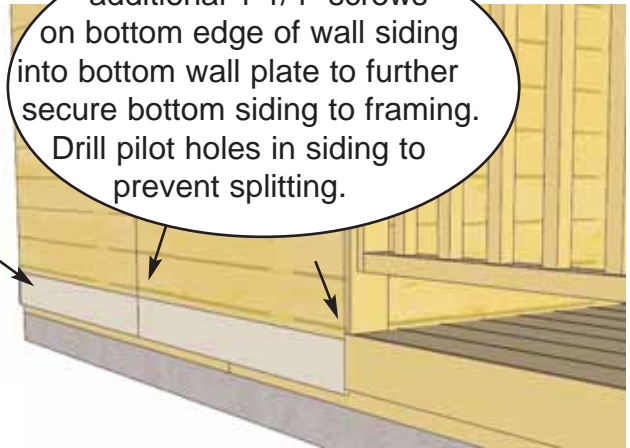

71. There are 2 Front Skirting Pieces that are 48 1/2" long. Use 6 finishing nails on both front skirting pieces for extra support since it will be a high traffic area.

Front Overhangs Side Skirting

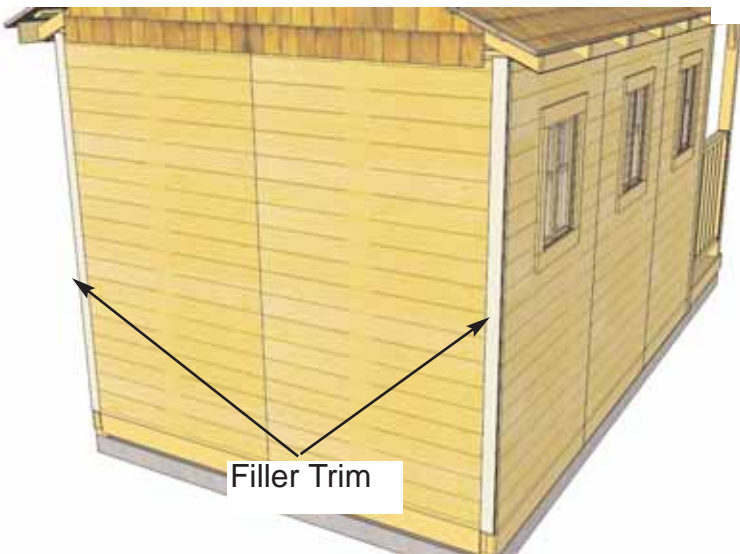
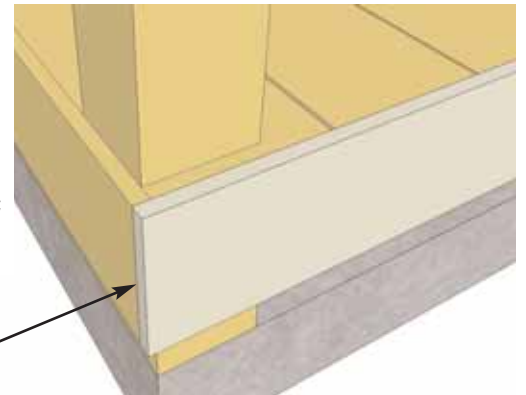

Filler Trim

72. Attach **Filler Trims** (2 - 1/2" x 2 1/2" x 75") to rear walls. Hammer with 8 - 1 1/4" finishing nails. Trims are positioned flush with siding and bottom skirting.





Wide Corner Trim

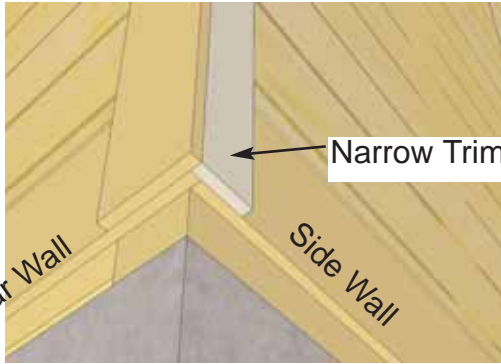

Narrow Trim

73. Attach Wide Trims

(2 - 1/2" x 4 1/2" x 82") over filler trim. Use 8 - 1 1/4" finishing nails per piece. Once again, align trim flush with bottom skirting. Do a dry run with a Narrow Trim piece to confirm alignment prior to attaching,



74. Attach six Narrow Trims

(6 - 1/2" x 2 1/2" x 79" long) to both sides of the shed. Use 8 - 1 1/4" finishing nails per piece. Align Trim so flush with bottom of bottom skirting and outside of filler trim.

75. Attach Rear Wall Seam

Trim (1 - 1/2" x 4 1/2" x 75") where back wall panels meet. Use 8 - 1 1/4" finishing nails to secure. Attach Both the Porch Trim and Door Trim to front walls. To complete trims, attach both Horizontal Trims above door and window. Use 4 - 1 1/4" finishing nails to secure each trim piece.



2 -44" long Trims.

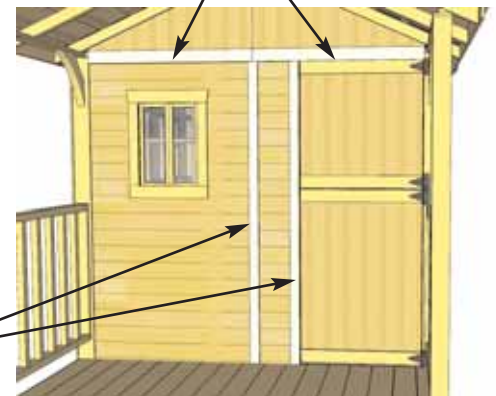

Porch & Door Trim



76. Position **Back Facia** (angle cut on ends) and **Side Facia** (square cut ends) in corner. Line Facia up so square cut Facia is positioned between angled cut facia. Attach angled facia to batten ends with 8 - 1 1/4" finishing nails per piece. Gap where facia boards come together at peak will be covered in **Step 78**. Do a dry run using Facia to help you correctly position before attaching.

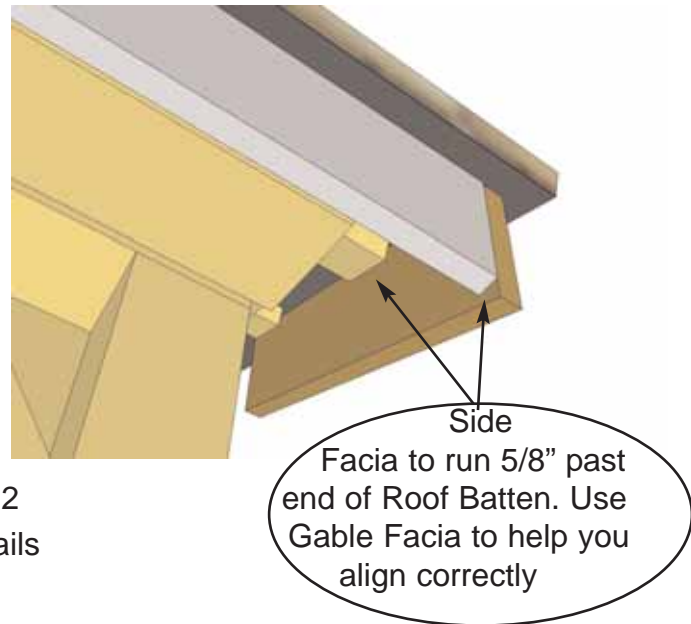

77. Attach **Side Facia** to roof rafter ends. There are 2 facia pieces per side. Secure with 8 - 1 1/4" finishing nails per piece. See Step 82 for final facia attachment



78. Attach **Pentagon Detail Plate** and **3 Facia /Trim Detail Plates** to cover seam where Facia pieces come together. Also use a Trim Detail Plate to cover the seam where the Horizontal Trim above the door and window come together. Secure with 4 - 1 1/4" finishing nails per piece.

Alternate left/right Ridge Caps

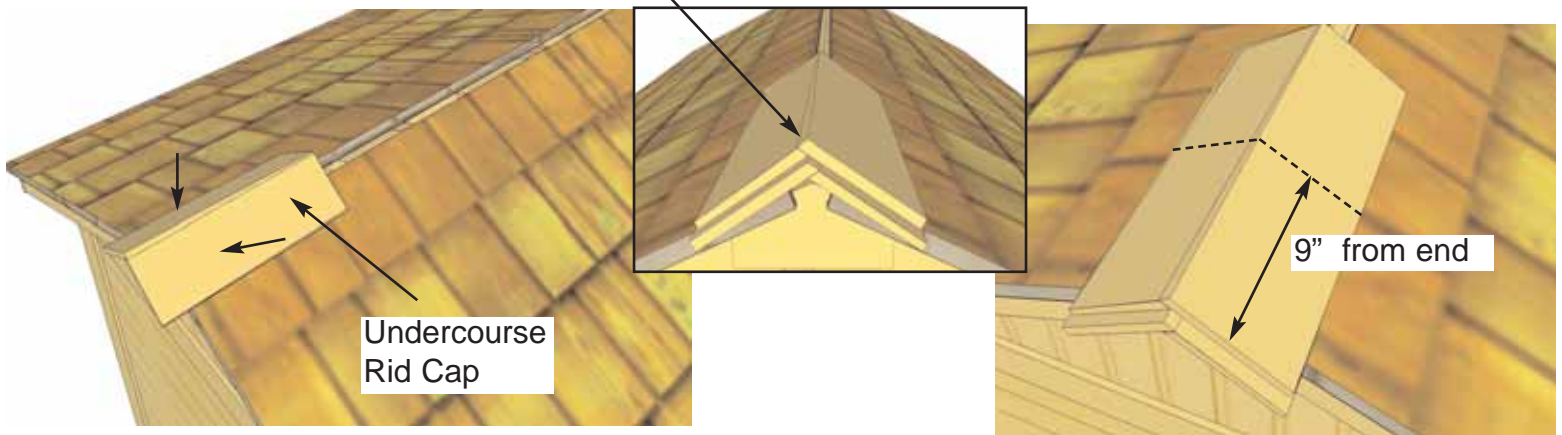

79. Place First Roof Ridge Cap (Lower Grade Undercourse Rid Cap) on roof peak overhanging shingles by approximately 2". Attach with 2- 1 1/2" Shingle Nails 9" from end. Place 2nd Ridge Cap 1" back from 1st cap. Attach with 2- 1 1/2" Shingle Nails 9" from end. There are left/right Ridge Caps, alternate each Ridge Cap as you proceed.

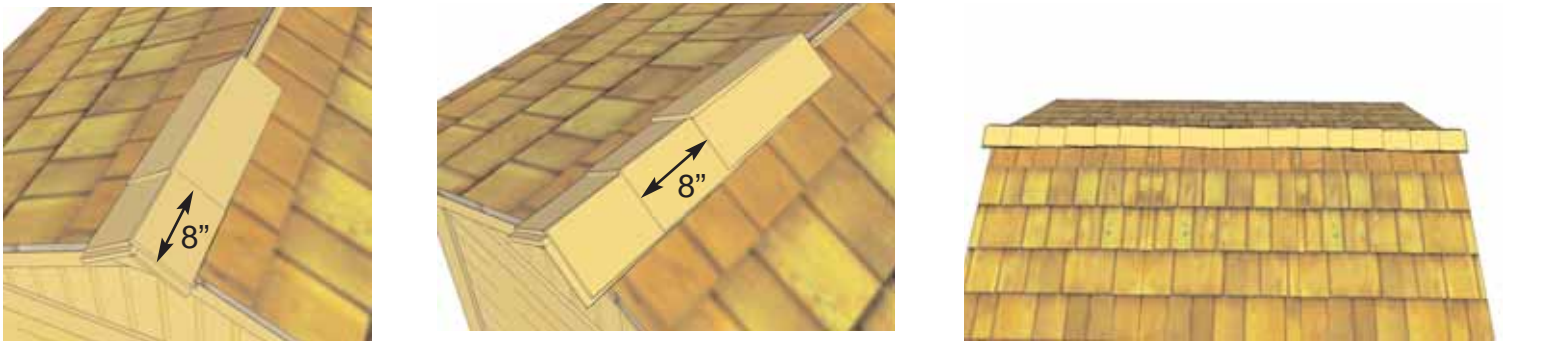

80. Place 3rd Ridge Cap 8" back from 2nd. (enough to cover shingle nails). Attach 3rd Ridge Cap down as per **Step 79**. Continue to position and attach Ridge Caps until half roof is complete. From opposite side, position and attach Ridge Caps as described above. Score/cut 1 Ridge Cap to 12" or to fit in the center of roof. Attach center cap with 4 - 1 1/2" Shingle Nails.

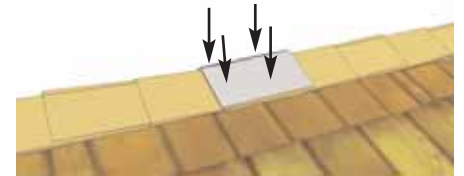

81. Attaching the Gable Gusset is next, screw a 90 degree Simpson Strong Tie up into 3rd and 5th batten of roof panel with 2-1 1/4" screws flush to end of batten. (see picture)

Place **Decorative Gusset Gable** underneath porch roof so peaks line up. Lift up underneath Gusset Gable until seams meet. Mount with 2- 1 1/4" screws into each Strong Tie.

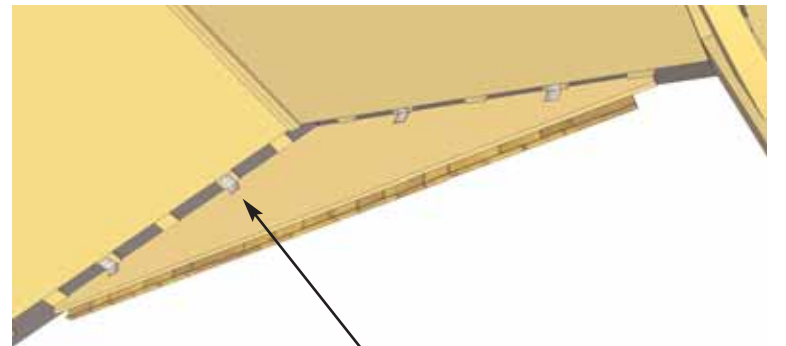

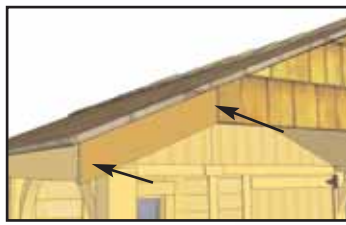
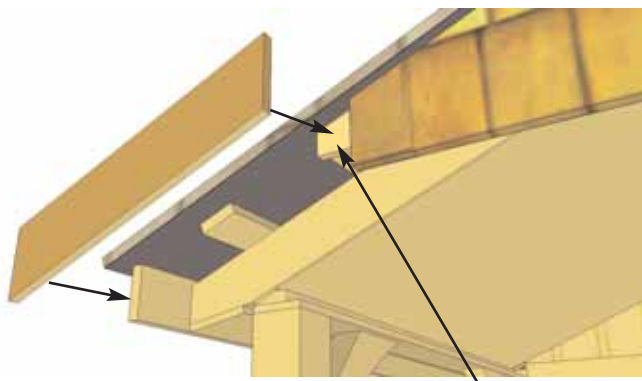

exposed plywood of gable

82. Attach **Gable Facia** to exposed plywood of gable with 2 - 1 1/4" finishing nails. End of gable facia will attach to side facia with 2 - finishing nails. Complete both sides.

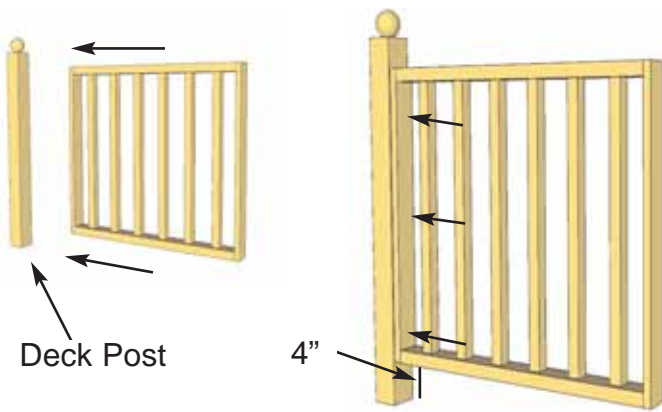

83. To complete porch, attach Deck Post and Handrail Section together. Measure 4" from bottom of post to align rail. Attach rail to post with 3 - 1 1/2" screws. Place Post/Handrail section on deck.

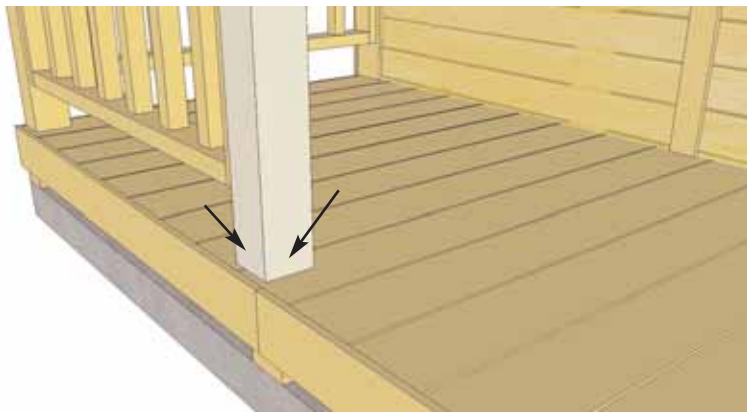

84. Toe-nail Short Post to Deck with 3 - 2 1/2" screws per post. Drill pilot holes to avoid splitting posts.



85. Attach **Flower Boxes** below bottom of window trim with 2 - 2" screws per box. Screw from inside of box into the center wall stud. Attach second screw 2" below top screw.



86. Attach **Door Handle, Exterior Barrel Bolt** and **Interior Barrel Bolt** to door. Handle is positioned on top door, Barrel Bolt on bottom door and Interior Barrel Bolt (silver) to top door stud. Attach Black Barrel Bolt as illustrated above with 3/4" Black Screws. Note how female part of Barrel Bolt is positioned higher than male. Do a dry run first to position Barrel Bolt correctly. **Important** - Drill shallow pilot holes with 1/8" drill bit prior to securing with screws to prevent wood splitting.

87. Attach Horizontal and Vertical **Door Stops** to door jamb and wall framing. Use 4 - 2" screws to secure. Door Stop should overhang the door by approximately 1/2". Start with the Horizontal Stop first.

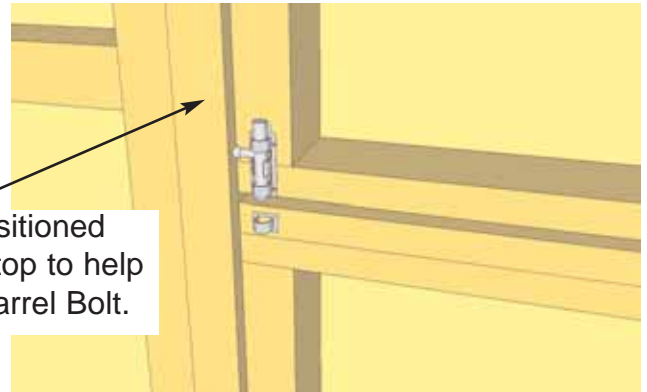

Temporarily positioned Interior Door Stop to help align Interior Barrel Bolt.



88. Attach **Post Base Trims** to bottom of porch posts. Attach with 1 1/4" finishing nails.

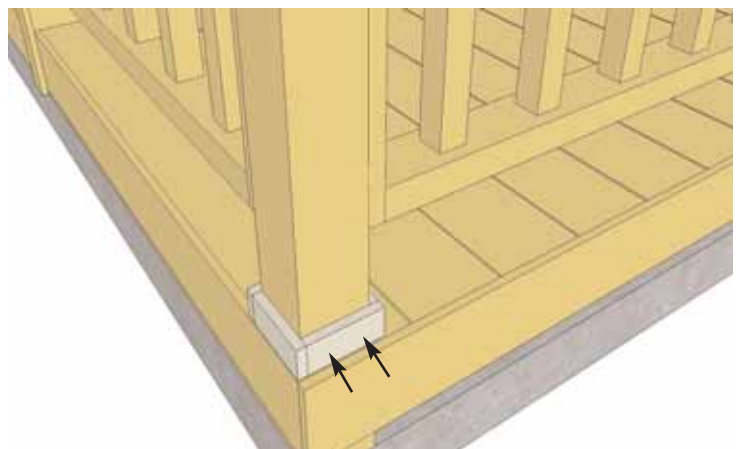
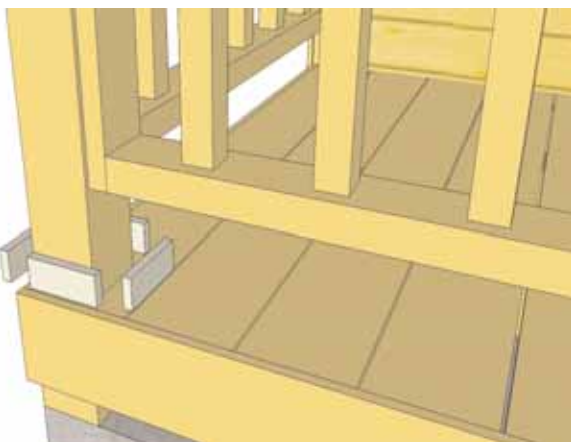

Congratulations on building your 8x12 Santa Rosa Garden Shed!

Note; Our Sheds are shipped as an unfinished product. If exposed to the elements, the western red cedar lumber will weather to a silvery-gray color. If you prefer to keep the cedar lumber looking closer to the original color, we suggest that you treat the wood with a good oil base wood stain. You may also wish to paint your new shed rather than stain it. In both cases we recommend that you consult with a paint and stain dealer in your area for their recommendations.



We hope your experience constructing our building has been both positive and rewarding.

We value your feedback and would like to hear back from you on how well we are doing in the following areas:

1. Customer Service
2. On Time Shipping
3. Motor Freight Delivery
4. Quality of Materials
5. Assembly Manual
6. Overall Satisfaction.

Please call, write or email us at:

Outdoor Living Today Partnership
P.O. Box 96
Sumas, Washington
98295



The materials contained in this Assembly Manual may be downloaded or copied provided that ALL copies retain the copyright and any other proprietary notices contained on the materials. No material may be modified, edited or taken out of context such that its use creates a false or misleading statement or impression as to the positions, statements or actions.