

Cola Gazebo

Style # L-GZ071PST

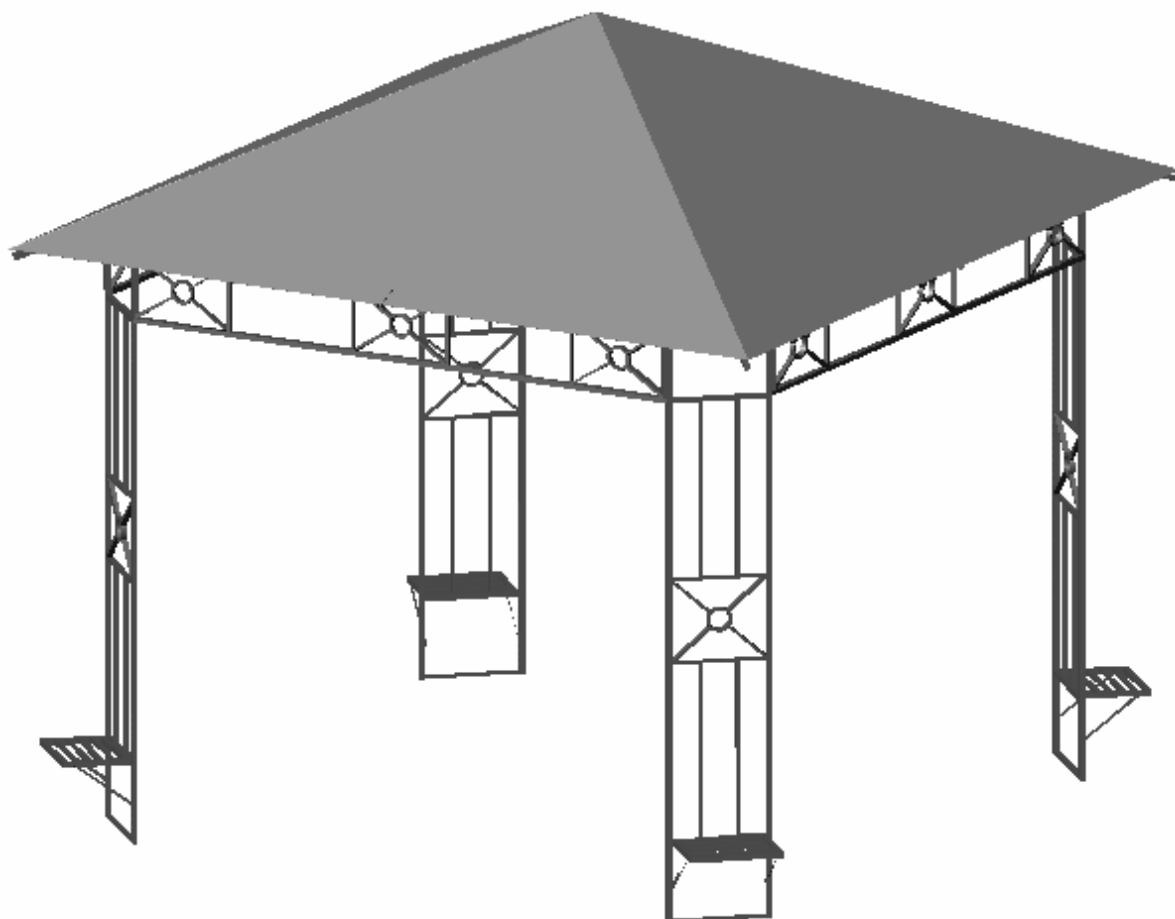

Recommended persons for safe assembly: 3.

CONGRATULATIONS – You've purchased a fine item from The Home Depot.

Our clear, easy to follow; step by step instructions will guide you through the project from start to finish. Feel confident that this will be a fun and rewarding project. The final product will be a quality piece that will go together smoothly and give years of enjoyment.

All you will need is a screwdriver, a hammer, and a ladder not lower than 2m (about 6.6 feet).

If you have any questions just call 866-578-6569. Please refer to the DPCI code about when calling.

Step Identification

For ease of identification all parts are labeled to correspond to the Step number in which the part is used.

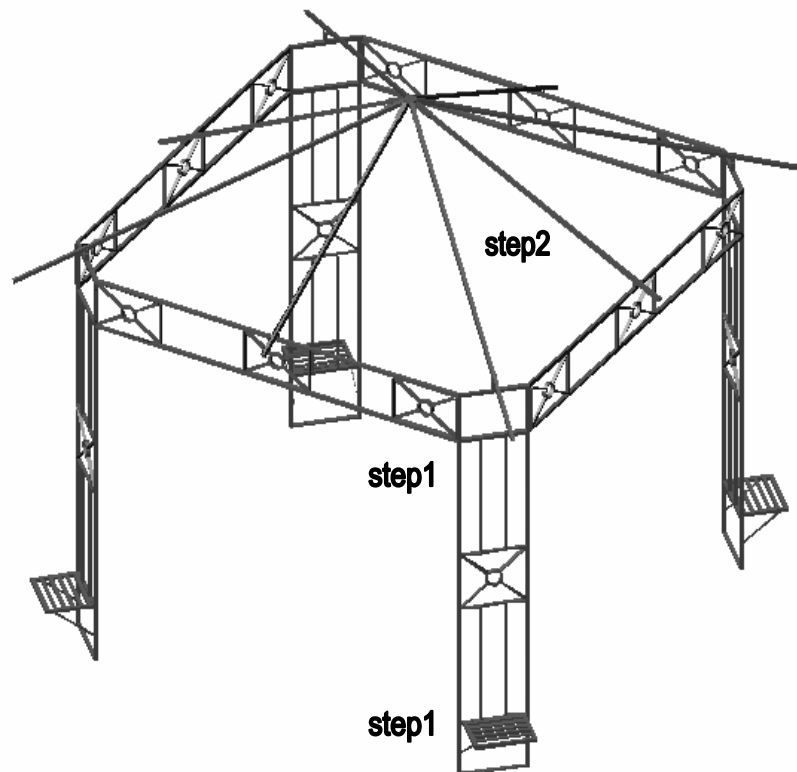





IMPORTANT:

1. When installing and assembling your gazebo, it's recommended that 2 or more persons are involved.
2. Do not use the unit during an electrical storm, as there is a remote chance of getting struck by lightning.
3. Do not climb on top of the gazebo. Falling off the gazebo can result in serious injury, possibly even death.
4. Do not leave the gazebo assembled when there is a risk of high wind, as damage will occur to the structure.
5. Never barbecue under this gazebo or use lanterns that contain naked flames.
6. This package contains small items and plastic bags that should be kept away from children.
7. Ensure that any connectors & poles are firmly secured in position fully. It is important to do so before use so as to avoid collapsing or damage to the item, which could result in injury.

WARNING:

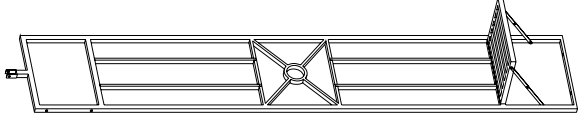
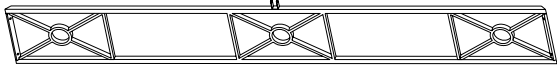
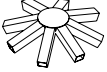
1. KEEP ALL FLAME AND HEAT SOURCES AWAY FROM THIS GAZEBO FABRIC.
2. This Gazebo is made of Fabric that meets CPAI-84 specifications for flame resistance. It is not fire proof. The fabric will burn if left in continuous contact with any flame source. The application of any foreign substance to the gazebo fabric may render the flame-resistant properties ineffective.
3. Due the natural properties of metal frame material, if rust develops, clean rust area by sanding slightly, then wipe thoroughly and apply touch-up paint that is contained in the package.





Parts List

NO.	Part	Qty.	Picture
1A	Standing Screen	4	
1B	Top decorative screen	4	
2A	Top connector	1	
2B	Top long bar	4	
2C	Top short bar	4	
2D	Canopy	1	





Hardware Identification

For ease of identification all hardware is organized into separate Hardware packs.

Hardware Pack 1

16 pieces	(AA) M6x20 bolt (TBZ00106020HQ)	
16 pieces	(BB) M6 Big flat washer (TBZ10806HQ)	
8 pieces	(CC) 6x180 Peg (TBZ10706180XQ)	
2 pieces	(WW) M6 Wrench	

Hardware Pack 2

8 pieces	(DD) M6x25 bolt (TBZ00106025HQ)	
16 pieces	(BB) M6 Big flat washer (TBZ10806HQ)	
8 pieces	(EE) M6 Nut (TBZ20106HQ)	
8 pieces	(FF) M6 plastic cap (TBZ11306HQ)	

STEP #1 Screens

(X16) AA 

(X16) BB 

(X8) CC 

(X2) WW 

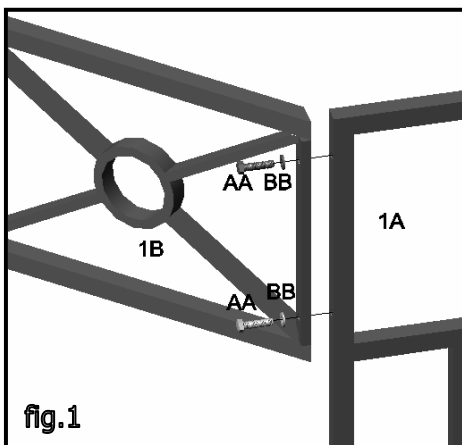
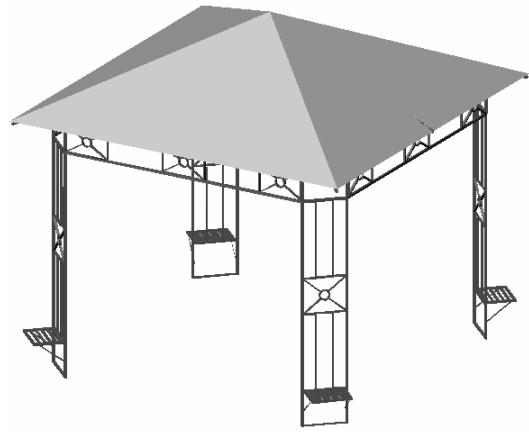

fig.1

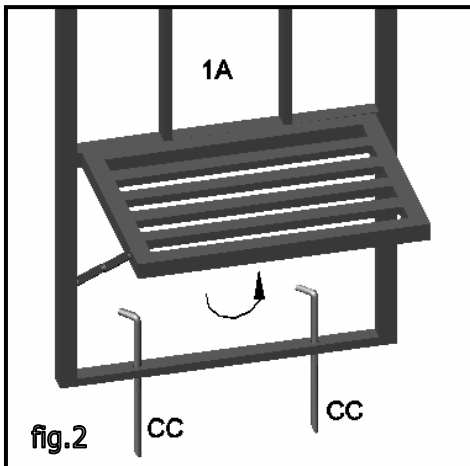

fig.2

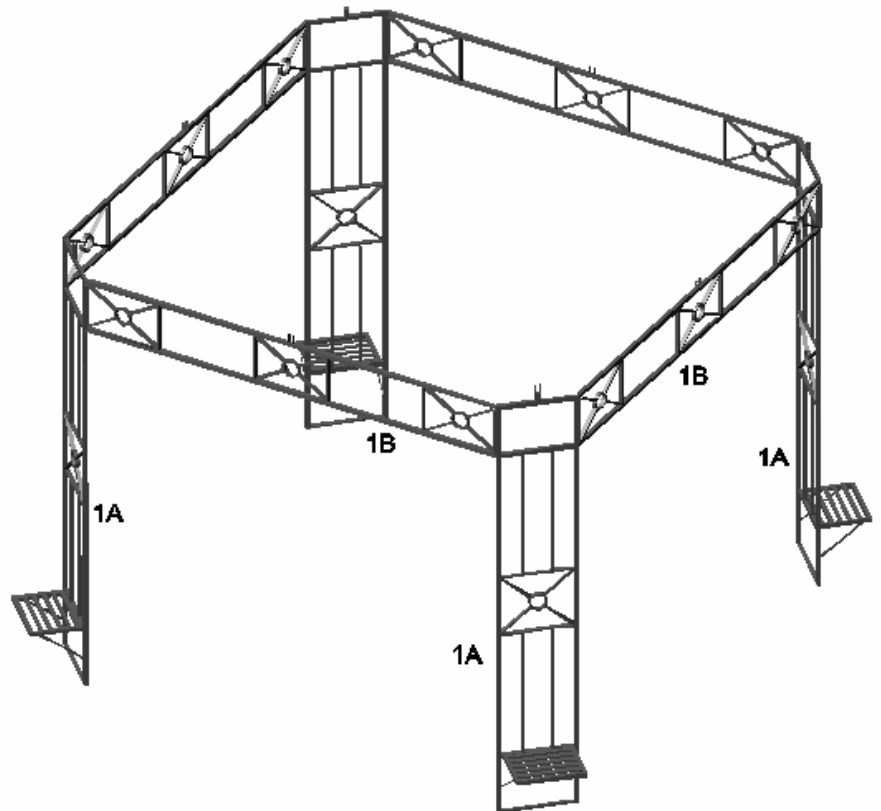

Fig.1: Attach 1B onto 1A and use bolts AA and washers BB to secure them.

Fig.2: Fold up the planter attached to 1A (pre-assembled), so as to peg stakes CC onto ground easily to make the frame sturdy for following assembly. Pay attention that before you peg the stakes, please make sure all the bolts and screws are secured and your gazebo is in a proper place.

STEP #2 Top, Canopy

(X8) DD 

(X16) BB 

(X8) EE 

(X8) FF 

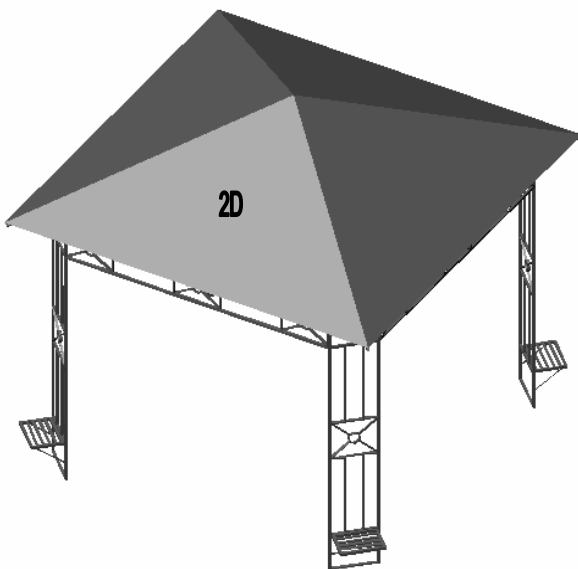
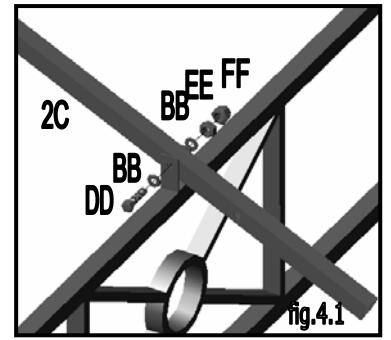
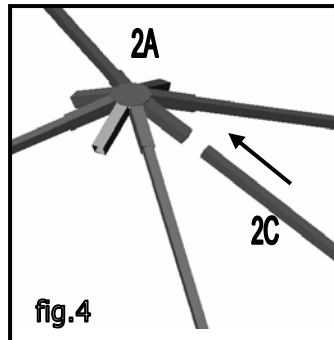
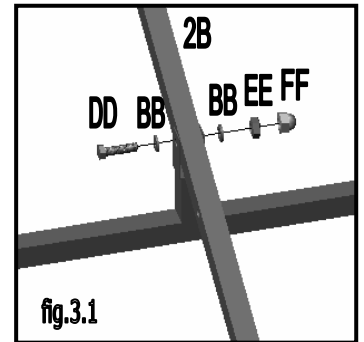
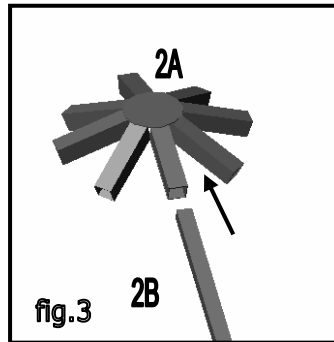
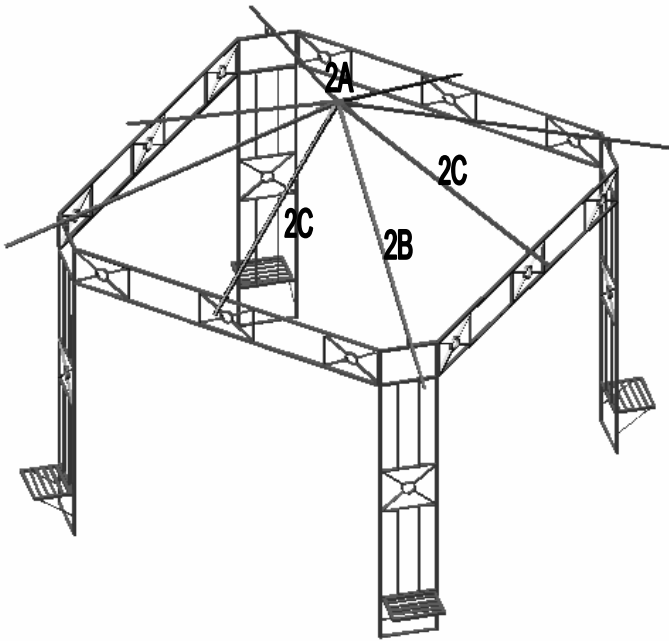
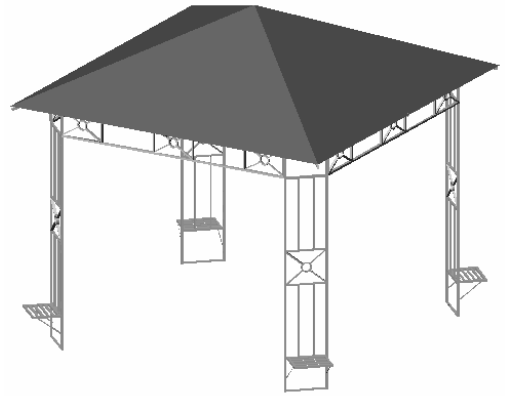

Fig.3: Insert one end of 2B into 2A, and connect the other end of it with 1A, using bolts DD, washers BB, nuts EE and plastic caps FF to secure them.

Fig.4: Insert one end of 2C into 2A, and connect the other end of it with 1B, using DD, BB, EE, FF to secure them.

Put the canopy 2D onto the frame, and finally your gazebo is ready for use.

Limited Warranty:

This limited warranty is extended to the original purchaser and applies to defects in materials and workmanship of your item provided the item is maintained with care and used only for personal, residential purposes.

The item is warranted to be free from defects in material or workmanship for a period of **6 month**. We don't reimburse for transportation or delivery costs, or compensate the individual or any outside party for assembling or disassembling the product.

Exclusions:

Items used for commercial, contract, or other non-residential purposes, or items damaged due to acts of nature, vandalism, misuse, or improper assembly are not covered. Corrosion or rusting of hardware is not covered. Proof of purchase (dated register receipt) is required for warranty claims. Warranty is to the original purchaser and is non-transferable. Any replacement of warranted items will be in the original style and color, or a similar style and color if the original is unavailable or has been discontinued. As some states do not allow exclusions or limitations on an implied warranty, the above exclusions and limitations may not apply. This warranty gives you specific rights, and you may also have other rights, which vary from state to state.

Maintenance:

Our iron/steel components for garden accessories and furniture are coated with rust inhibiting paint that protects it from rusting. However, due to the nature of iron, surface oxidation (rusting) will occur once these protective coatings are scratched. This is a natural process and is not a defect! To minimize this condition, we recommend care when assembling & handling the product to prevent scratching the paint. Should any scratching or damage occur, we recommend immediate touch-up with rust inhibiting paint. Surface rust can also be easily removed with a very light application of common cooking oil. If surface oxidation (rusting) occurs and if no measure is taken to prevent this, the oxidation may start dripping on to deck or patio and cause damaging stains, which may be difficult to remove. This can be prevented if measure is taken to keep the product from oxidizing.

Important: Please do not return this product to the store. For technical assistance on assembly or replacement parts Please do not return this product to the store, call Sunjoy Industries at 1(866) 578-6569 from 8:30 AM to 5:30 EST Monday to Friday or fax the replacement part form which put into the package to (740)-283-3549 or Email thd07@sunjoygroup.com for assistance.

Distributed by Home Depot U.S.A., Inc.
2455 Paces Ferry Rd.N.W.
Atlanta, Georgia 30339
Made in China

Limited Warranted by Sunjoy Industries
15709 Unit#1, Arrow Highway
Irwindale, CA 91706