

# Installation

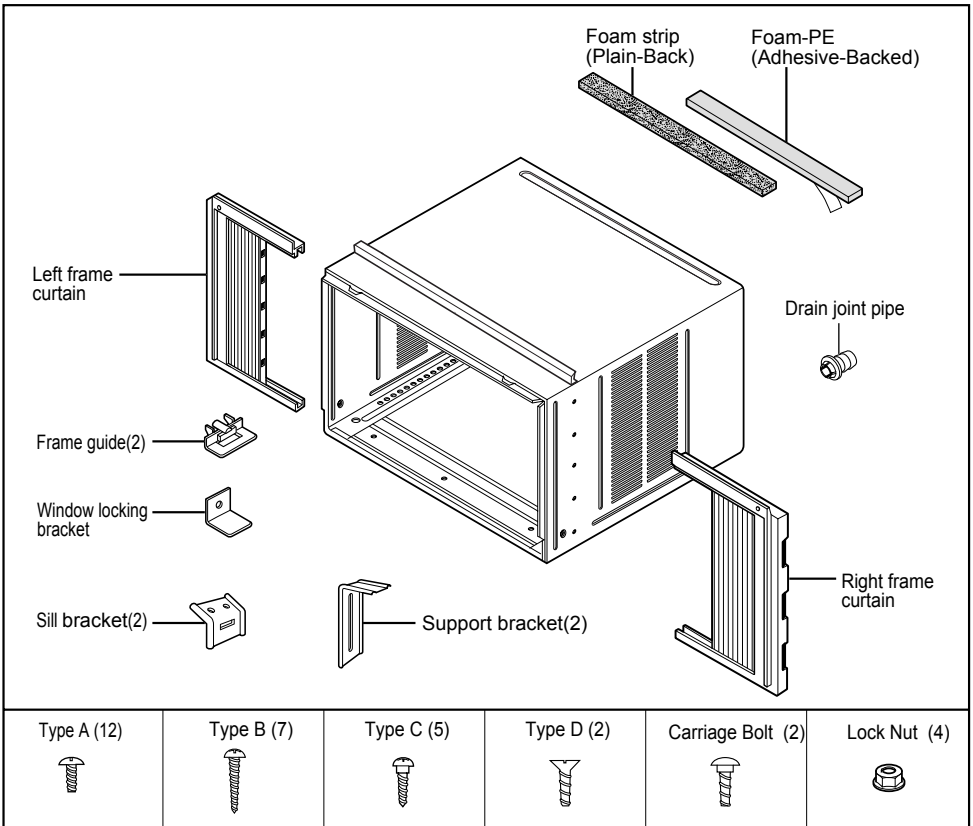

Have the following tools available for installation:

\* Phillips head screwdriver

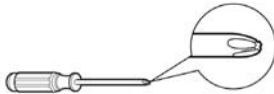

\* Ruler



\* Scissors or knife



\* Level



\* Pencil



\* Flat - blade screwdriver



\* Adjustable Wrench



## Window Requirements

### NOTICE

All supporting parts should be secured to firm wood, masonry, or metal.

1. This unit is designed for installation in standard double hung windows with actual opening widths from 29" to 41". The top and bottom window sashes must open sufficiently to allow a clear vertical opening of 19" from the bottom of the upper sash to the window stool.
2. The stool offset (height between the stool and sill) must be less than 1 1/4".

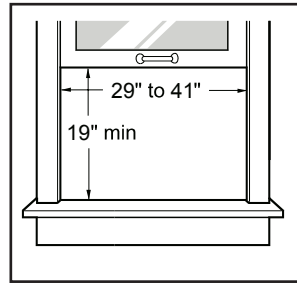

## Preparation Of Chassis

1. Remove 4 screws which fasten the cabinet at both sides and at the back. (Keep the screws for later use.)

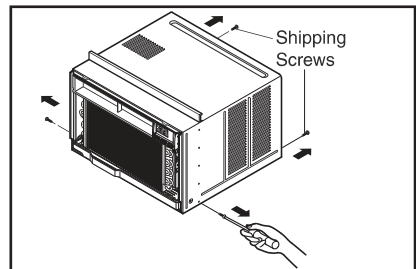

2. Slide the unit from the cabinet by gripping the base pan handle and pulling forward while bracing the cabinet.

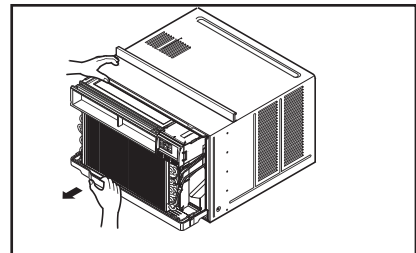

3. Cut the window sash seal to the proper length. Peel off the backing and attach the Foam-PE (adhesive backed) to the underside of the window sash.

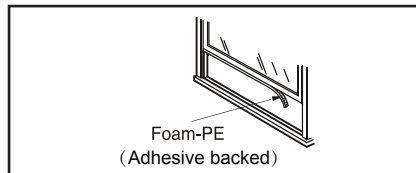

4. Insert the frame guides into the bottom of the cabinet.

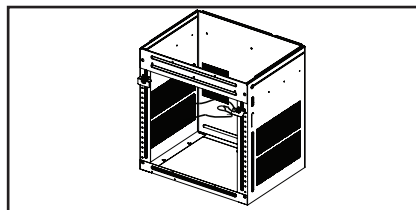

5. Insert the frame curtain into the upper guide and frame guides.
6. Fasten the curtains to the unit with 10 Type A screws.

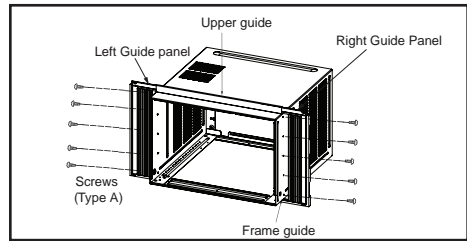

## Cabinet Installation

1. Open the window. Mark a line on the center of the window stool.
- Loosely attach the sill bracket to the support bracket using the carriage bolt and the lock nut.

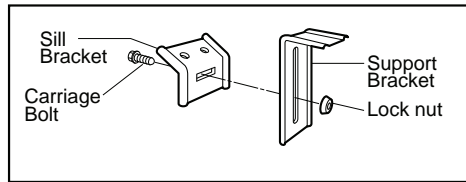

2. Attach the sill bracket to the window sill using the screws (Type B).
- Carefully place the cabinet on the window stool and align the center mark on the bottom front with the center hole marked window stool.

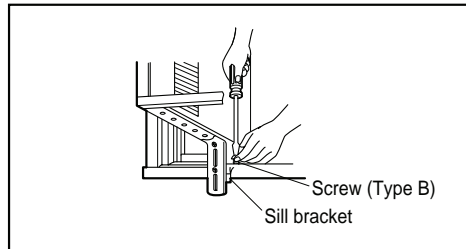

3. Using the screw (Type D) and the lock nut, attach the support bracket to the cabinet track hole. Use the first track hole after the sill bracket on the outer edge of the window sill. Tighten the carriage bolt and the lock nut. Be sure the cabinet slants outward.

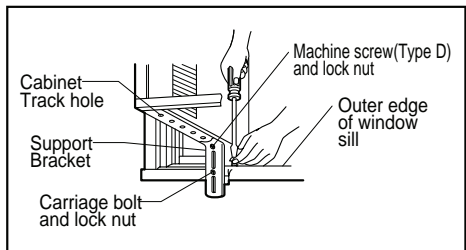

4. Pull the bottom window sash down behind the top retainer bar until they meet.

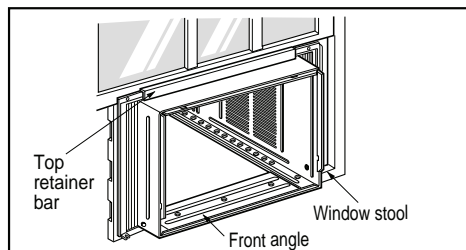

### ⚠ CAUTION

Do not drill a hole in the bottom pan. The unit is designed to operate with approximately 1/2" of water in bottom pan.

**NOTICE**

1. Do not pull the window sash down so tightly that the movement of frame curtain is restricted. Attach the cabinet to the window stool by driving the screws (Type B) through the cabinet into window stool.
2. The cabinet should be installed with a very slight tilt downward toward the outside.

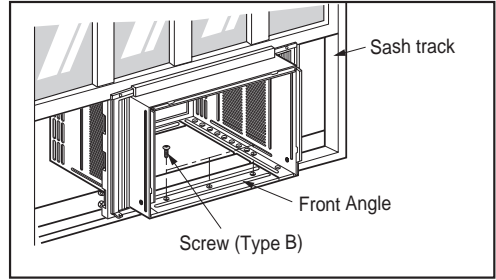

3. Pull each frame curtain fully to each window sash track, and pull the bottom window sash down behind the top retainer bar until it meets.
4. Attach each frame curtain the window sash by using screws (Type C) .

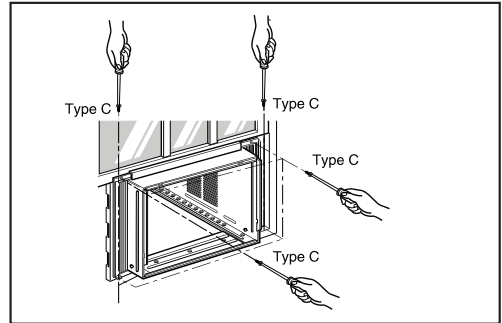

5. Slide the unit into the cabinet.

**CAUTION**

For security purpose, reinstall screws (removed from cabinet) at cabinet's sides. See page 12.

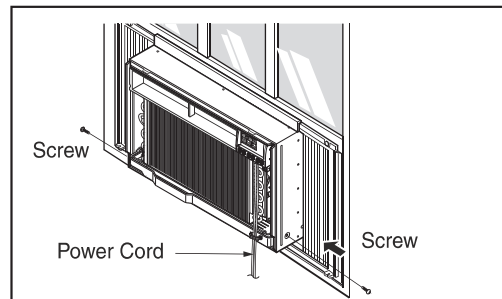

6. Cut the foam-strip (not adhesive backed) to the proper length and insert between the upper window sash and the lower window sash.

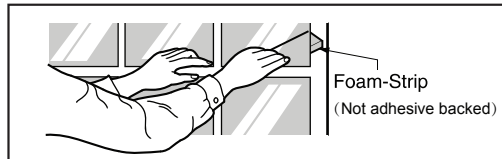

7. Attach the window locking bracket with a screw (Type C) .

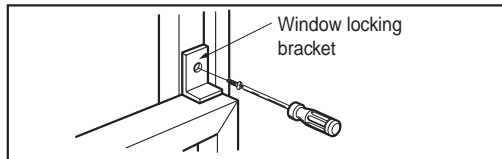

8. Before installing the front grille, pull out the vent control lever located above the unit control knobs, as shown.

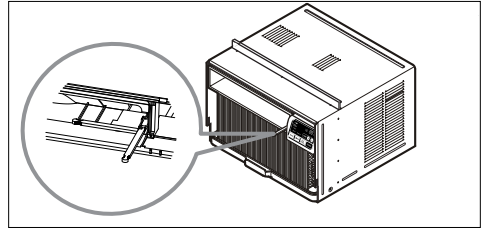

9. Attach the front grille to the cabinet by inserting the tabs the grille into the slots on the front the cabinet. Push the grille in until it snaps into place.

**NOTICE**

Guide the lever carefully through the grille as you push it in.

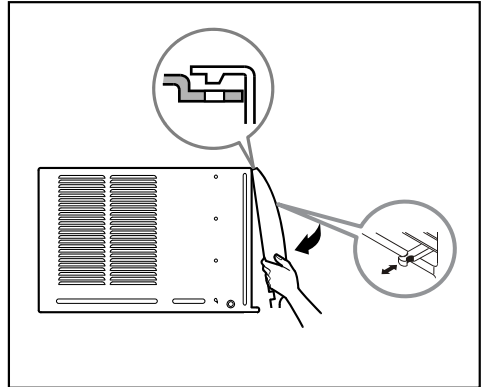

10. Put down inlet grille and take out the filter and secure it with 2 Type A screws through the front grille.

**NOTICE**

These 2 Type A screws are packaged by bag.

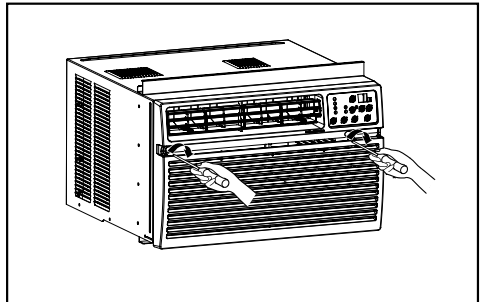

Window installation of room air conditioner is now completed. See ELECTRICAL DATA for attaching power cord to electrical outlet.