

TROUBLESHOOTING:

	Possible Cause	Corrective Action
Bulb will not light	1. Bulb is burned out	1. Replace light bulb
	2. Switch is off	2. Make sure switch is on
	3. Faulty wire connection	3. Check wiring
Fuse blows or circuit breaker trips when light is turned on	Crossed wires or power wire is grounding out	Check wire connections



INSTRUCTION MANUAL INTERIOR 1-LIGHT WALL SCONCE PALOMA

**HOME DEPOT SKU 628-035 (UPC 773546224710)
OIL RUBBED BRONZE FINISH**

PRODUCT MAINTENANCE:

1. To clean the outside of the lamp, use a dry or slightly dampened clean cloth (use clean water, never a solvent) to wipe the shade and surface of the lamp.
2. To clean the inside of the fixture, first disconnect power to the fixture by turning off the circuit breaker or by removing the fuse at the fuse box. Next, use a dry or slightly dampened clean cloth (use clean water, never a solvent) to wipe the inside shade and interior surface of the fixture.
3. Do not use any cleaners with chemicals, solvents or harsh abrasives. Use only a dry soft cloth to dust or wipe carefully.

LIMITED WARRANTY

The manufacturer warrants this lighting fixture to be free from defects in materials and workmanship for a period of five (5) years from date of purchase. This warranty applies only to the original consumer purchaser and only to products used in normal use and service. If this product is found to be defective, the manufacturer's only obligation, and your exclusive remedy, is the repair or replacement of the product at the manufacturer's discretion, provided that the product has not been damaged through misuse, abuse, accident, modifications, alterations, neglect or mishandling. This warranty shall not apply to any product that is found to have been improperly installed, set-up, or used in any way not in accordance with the instructions supplied with the product. This warranty shall not apply to a failure of the product as a result of an accident, misuse, abuse, negligence, alteration, or faulty installation, or any other failure not relating to faulty material or workmanship. This warranty shall not apply to the finish on any portion of the product, such as surface and/or weathering, as this is considered normal wear and tear. **The manufacturer does not warrant and specially disclaims any warranty, whether express or implied, of fitness for a particular purpose, other than the warranty contained herein. The manufacturer specifically disclaims any liability and shall not be liable for any consequential or incidental loss or damage, including but not limited to any labor / expense costs involved in the replacement or repair of said product.**

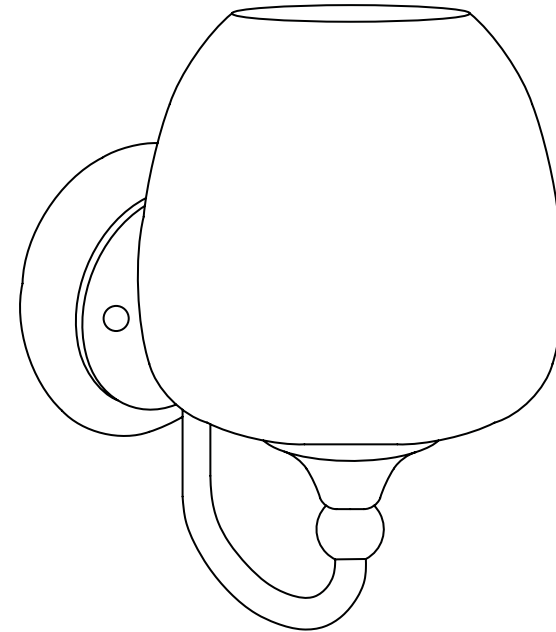

Thank you for purchasing this Hampton Bay interior decorative lighting. This product has been manufactured with the highest standards of safety and quality.

FEATURES:

This richly finished transitional series of vanity light with opal glass shades, easily adds sophisticated style to any home & lighting décor.

QUESTIONS, PROBLEMS, MISSING PARTS:

Before returning to your local Home Depot, please call our Customer Service Team at 1-877-527-0313 or visit www.homedepot.com. Please reference your **SKU 628-035 or (UPC 773546224710)**.

CAUTION:

1. Before starting installation of this fixture or removal of a previous fixture, disconnect the power by turning off the circuit breaker or by removing the fuse at the fuse box.
2. CONSULT A QUALIFIED ELECTRICIAN IF YOU HAVE ANY ELECTRICAL QUESTIONS.
3. If you have any non-electrical question about this fixture, please contact our Customer Service Team at 1-877-527-0313 or visit www.homedepot.com. Please reference your **SKU 628-035 or (UPC 773546224710)**.
4. Keep your receipt and these Instructions for Proof of Purchase.

INSTALLATION:

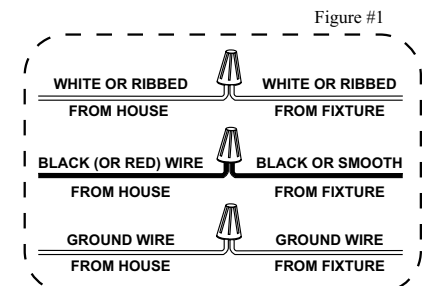
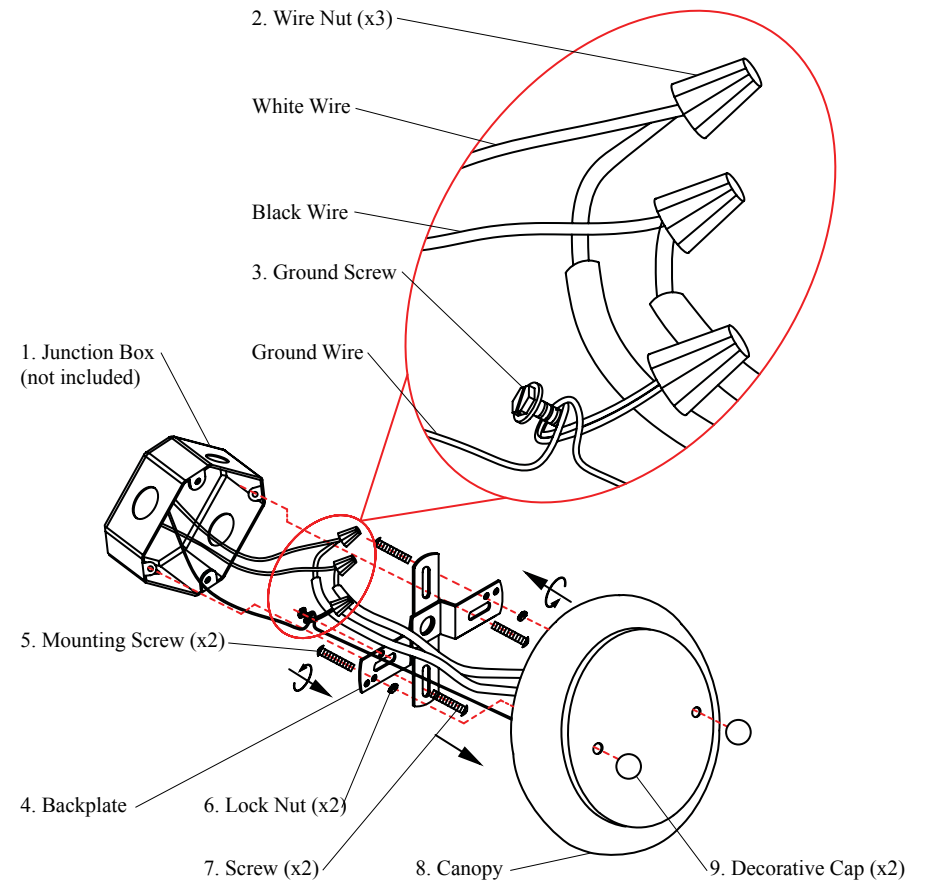

ADDITIONAL PARTS FOR INSTALLATION (included):

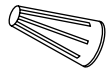

2. Wire Nut (x3)

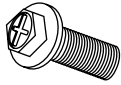

3. Ground Screw

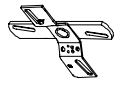

4. Backplate

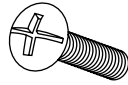

5. Mounting Screw (x2)

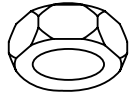

6. Lock Nut (x2)

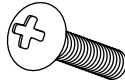

7. Side Screw (x2)

INSTALLATION INSTRUCTIONS:

1. Turn off power at main fuse box.
2. Install back plate (4) to junction box (1) with 2 mounting screws (5) supplied and secure with lock nut (6).
3. Fasten open end of ground wire (bare copper or green wire) to ground wire of junction box (1).
4. Connect black wire of power supply to black wire of sconce and white wire of power supply to white wire of sconce. (See Fig. 1)

NOTE: All wire connections should be made with wire nuts (5) or marrettes (included) and pushed back into junction back (1).

5. Mounting canopy of sconce (8) over the 2 screws (7) of back plate (4). Secure with 2 decorative caps (9).

TOOLS REQUIRED FOR ASSEMBLY & INSTALLATION (not included):



Safety goggles

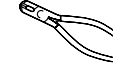

Wire Strippers

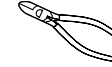

Wire Cutters

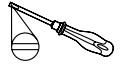

Flathead Screwdriver

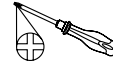

Phillips Screwdriver



Electrical Tape



A19 Bulb 60W Max (not included)

ADDITIONAL PARTS FOR ASSEMBLY (included):



9. Decorative Cap (x2)

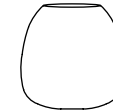

10. Glass Shade (x3)

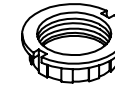

11. Socket Ring (x3)

ASSEMBLY INSTRUCTIONS:

1. Carefully unpack the fixture; lay out all parts on clean surface.
2. Slip glass (10) over socket, secure glass by tightening socket ring (11). Do not over tighten!
3. Install 60W max. type A19 bulb (not included) (12).

ASSEMBLY:

