

iRobot[®]

Looj[™]

Gutter Cleaning Robot

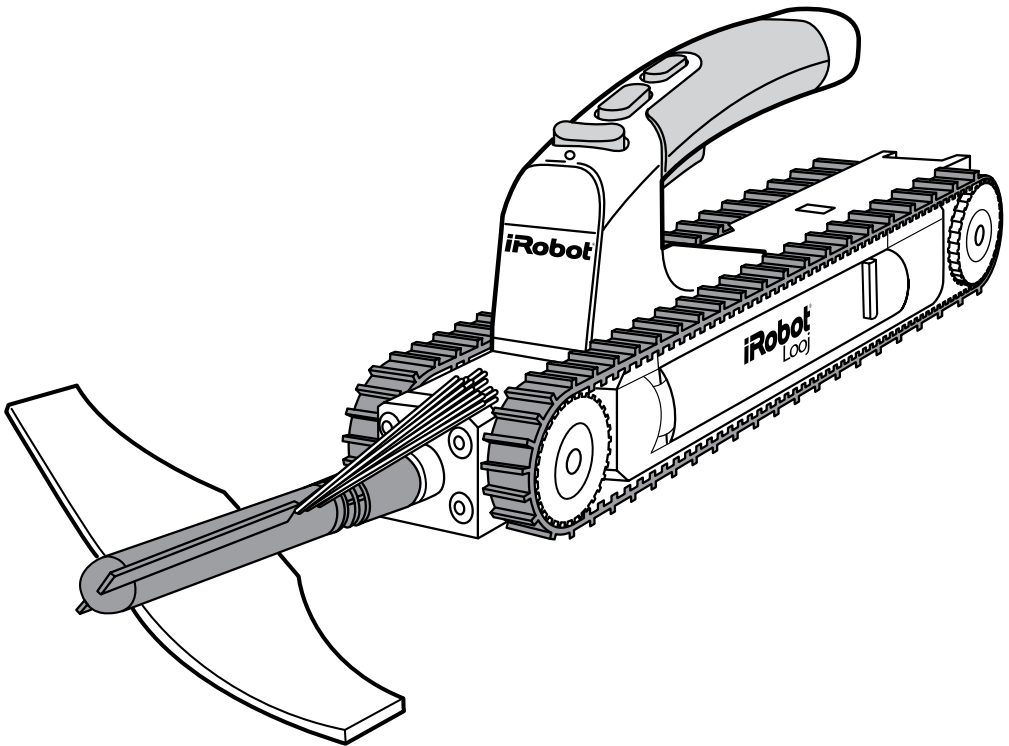

www.irobot.com

Welcome



Dear iRobot® Looj™ Owner,

Welcome to the world of iRobot. As an owner of the iRobot Looj Gutter Cleaning Robot, you join a growing group of people around the globe who, like you, are discovering an easier way to clean their gutters.

The use of practical robots that help you in and around your home is a new reality. We encourage you to share your feedback as we continue to develop new and groundbreaking robots. Here's what you can do to participate in our efforts:

- Communicate with us if you have questions, comments or require support. Contact us at **www.irobot.com**.
- Register online at **www.irobot.com/register** or by mail (see included card). You'll be among the first to hear about our newest robots, product enhancements, and special offers.

Thank you for joining the robot revolution. We look forward to your valued input as we continue to deliver groundbreaking products that will change and improve your world.

On behalf of the entire iRobot team,

A handwritten signature in black ink, appearing to read "Colin Angle".

Colin Angle
Co-Founder and CEO
iRobot Corporation

Important Tips

⚠ Before you use Looj, please read “Important Safety Instructions” on pages 20 and 21.

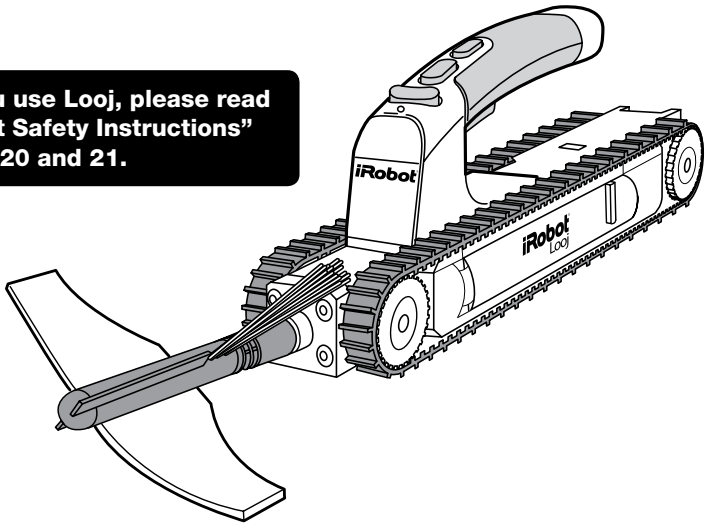

For Best Performance

- Charge the battery for 15 hours prior to using. For optimum battery life, do not store on charger for more than several days.
- For long-term storage, keep Looj in a cool, dry place and remove the batteries from the robot and handle. Do not keep the battery plugged into the charger during storage.
- Clean Looj after each use.
- To avoid overspill and sludge accumulation, clean your gutters at least once per season. Clean regularly in areas where heavy debris is collected.
- For the densest clogs, reverse Looj, allow it to eject debris over gutter, and drive it forward. Repeat this process until the clog is cleared.
- Use fresh AAA batteries in the remote control handle for maximum range.

⚠ If Looj's auger stops spinning and produces a loud clicking sound, the clutch is slipping. Reverse Looj to avoid damaging the clutch.

To see helpful operating and maintenance videos of Looj, please visit our website: www.irobot.com

Table of Contents

Anatomy	6
Product Description	7
Charging and Installing the Battery	8
The Remote Control Handle	10
Attaching and Removing the Auger	11
Using iRobot Looj	13
Maintenance	16
Troubleshooting.....	17
iRobot Customer Care	19
Important Safety Instructions	20
Limited Warranty	22

iRobot® Looj™ Anatomy

⚠ CAUTION: Never operate Looj without first attaching the auger to the drive shaft.

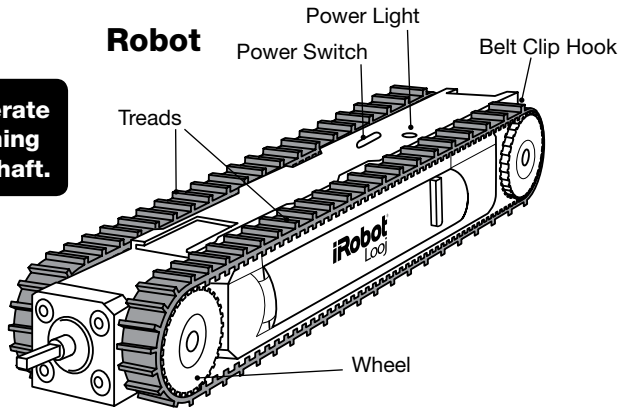

Auger

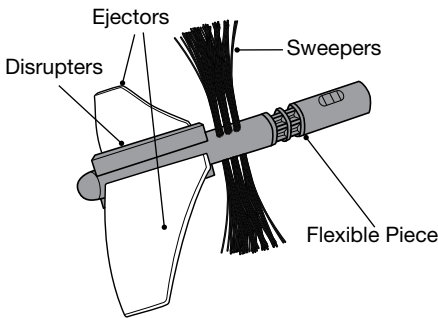

Remote Control Handle

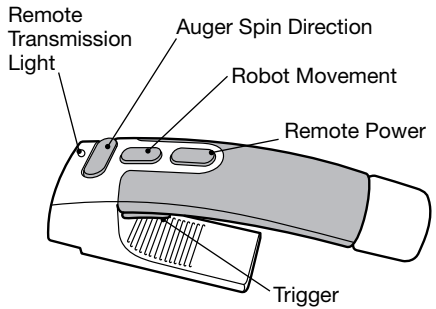

Battery Charger

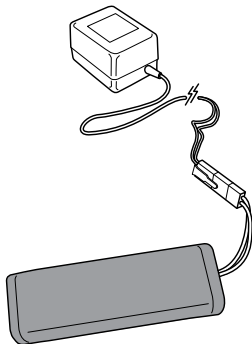

7.2V Rechargeable Battery

Belt Clip

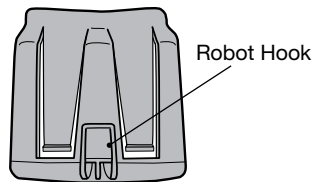

⚠ CAUTION: Never wear the Looj belt clip and robot in the front of your body. The belt clip must be worn on your side or behind you to avoid the robot being knocked off the clip while walking or climbing.

Product Description

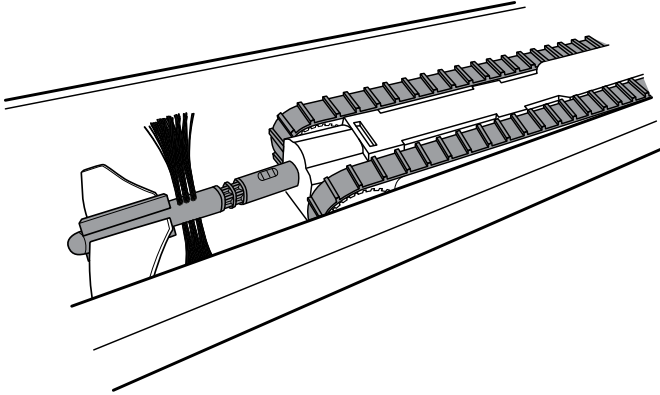

iRobot Looj is a powerful robot designed to clean gutters. Looj eliminates multiple climbs up and down the ladder. No more moving the ladder every six feet, or overreaching at dangerous heights. Looj has a number of features designed to make gutter cleaning simple and easy. Looj's ergonomic handle detaches for wireless control of the robot. The included belt clip lets you keep two hands on the ladder as you climb.

Cleaning Power: The robot uses a flexible three-stage auger to remove clogs, lift out the debris, and brush your gutters clean. Spinning at 500 RPM, the high speed auger disrupts, lifts, and tosses debris out of your gutters.

Remote Control Convenience: The remote control gives you complete forward and backward control of the robot. You can also control the spin direction of the auger to make sure that gutter debris is tossed in the correct direction, away from the roof.

iRobot Looj works in most standard gutters with straps or ties mounted at least 2¼" above the bottom trough. Looj is compatible with standard K-style gutters.

Tip: Remove items such as baseballs, large rocks, and tree branches by hand. Attempting to force Looj through solid debris could damage the robot.

Charging and Installing the Battery

Before you use Looj, charge the included 7.2V battery for 15 hours. Partially used and fully used batteries should also be charged for 15 hours. Do not leave Looj's battery plugged into the charger for more than several days, as it may reduce the battery life.

Looj batteries are designed to power Looj through 150 linear feet of gutter on a single charge, including the time to drive Looj back and forth during cleaning.

For long term storage, remove the battery from the robot, fully charge the battery and store it in a cool, dry place.

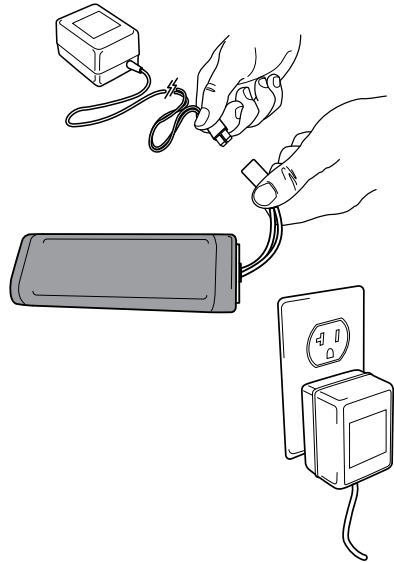

To install battery:

1. Depress the tab on the left side of the battery compartment. Open the door.
2. Connect the battery cord inside the robot's battery compartment.
3. Slide the battery into the battery compartment, wireless end first. Tuck extra wire into battery compartment. The wire cord will fit on the right side.

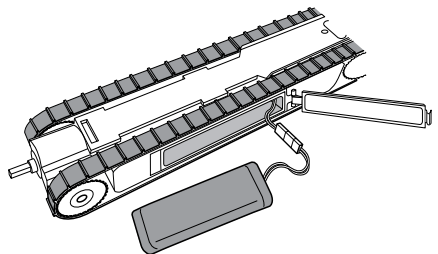
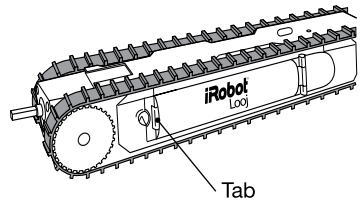

4. If used, wipe battery compartment door clean to ensure a proper seal.

5. Close door until it clicks.

Battery Tips

- Remove all batteries and store in a cool dry place when not in use.
- Do not leave battery charging for more than several days. Doing so may decrease battery life.
- The battery naturally loses charge while being stored. After storing for a season without charging, you will need to recharge the battery for 15 hours prior to using.
- See **www.irobot.com/support** for more details on the Looj batteries and charging.

The Remote Control Handle

The remote control handle detaches from Looj and is used to command the robot from a distance of up to 40 feet, depending upon environmental conditions. The remote control handle keeps your hands clean and makes it easy to place the robot in and out of the gutter using only one hand. Install two AAA alkaline batteries (not included) in the remote control handle before operating. To improve the range of the remote in metal gutters, see page 17.

Always use the same brand of batteries in the remote control handle. Don't mix battery types or brands. Use fresh batteries for maximum performance and range.

Insert AAA batteries into the remote control handle as shown.

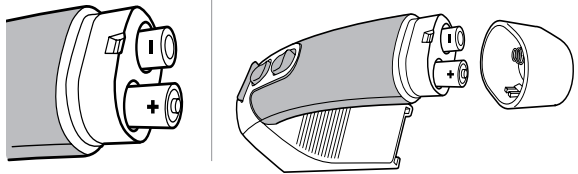

To attach the remote control handle to Looj:

1. Hold the remote control handle and align the front edge with the mark on the robot.

2. Slide the remote control handle onto the robot.

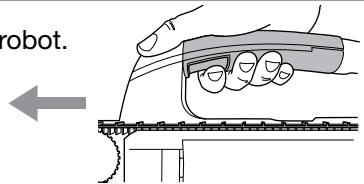

3. When you hear a snap, the handle is in place.

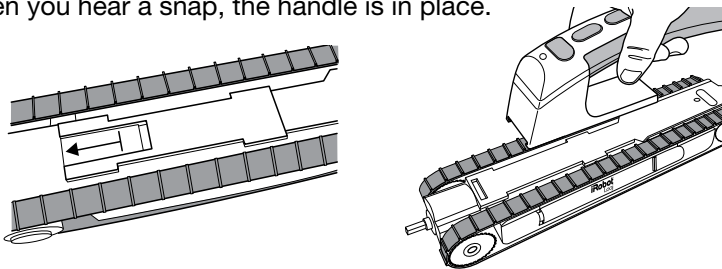

TIP: Make sure handle is securely attached to the robot before picking up the robot.

To remove the remote control handle from Looj:

Press trigger and slide remote control handle away from auger.

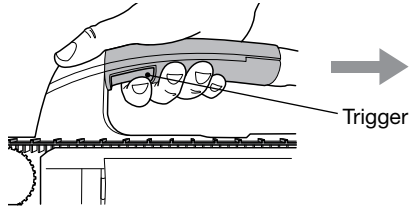

Attaching the Auger

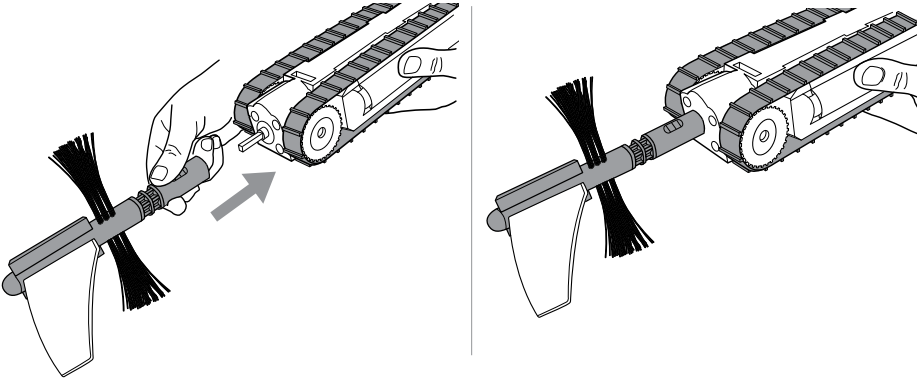

Push the auger onto the robot shaft until you feel it snap into place or hear a click.

Removing the Auger

Grasp auger at the finger indentation and pull. Grabbing and pulling the auger at the flaps could cause a tear.

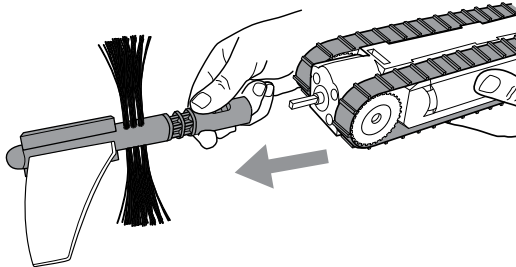

Attaching the Looj Belt Clip

The Looj belt clip is designed to hold Looj while you climb up and down the ladder. Always use the belt clip or the optional holster accessory (see below) when using Looj on a ladder.

Hook the belt clip over belt where Looj will be secure and easy to reach. Attach the robot to the robot clip.

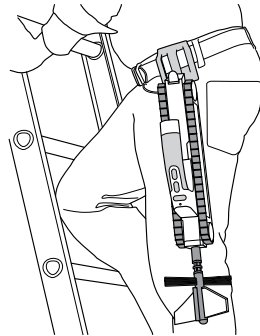
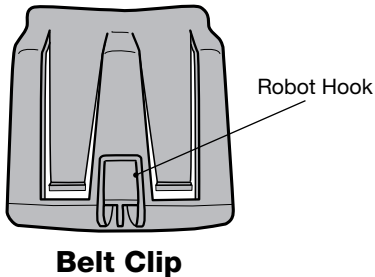

⚠ CAUTION: Always keep the belt clip on the side of your body. Placing the robot in the front may cause it to be kicked by your leg and fall off.

⚠ CAUTION: Never use Looj on a ladder without the belt clip or the holster to hold the robot while you climb or descend.

Looj Holster Accessory (optional, not included in all models)

Use the Looj Holster Accessory as a storage device and to keep your clothing clean while carrying Looj. The holster includes a belt and a pouch to hold the fully assembled Looj and remote control handle. There is also a loop on the back for hanging.

- Place Looj in the holster with the auger facing up.

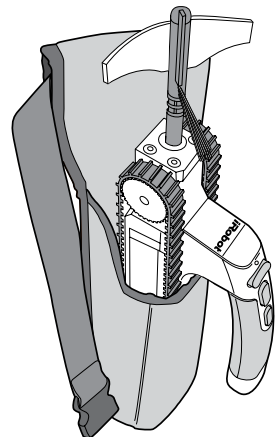

Using iRobot® Looj™

Always test Looj before using it.

Prior to using Looj in a gutter, try driving forward and backward on the ground. Try spinning the auger in both directions. Note the lights on the remote control handle and on the robot blink during transmission.

Also, practice attaching and detaching the handle as described on page 10.

Using Looj

1. The optimum spot for ladder placement is away from wires, hazards, on flat ground, etc. Read and follow ladder instructions provided by the ladder manufacturer before using a ladder. See “Important Safety Instructions” section for more details.
2. Attach Looj to the belt clip or place Looj into holster.
3. Climb the ladder.
4. Remove debris from gutter at the corner of the roof. Place Looj in gutter. Remove debris from gutter directly in front of ladder. If you do not, you may be sprayed by debris when Looj begins to operate.

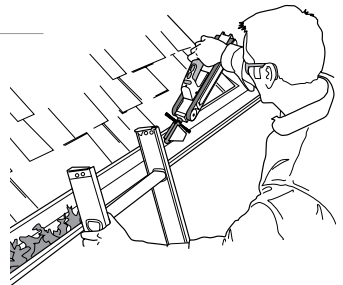

⚠ CAUTION: Wear safety glasses when using Looj to protect your eyes from debris.

5. Press the power switch on the robot to turn it on. The power light should be green to indicate that its battery is charged. A red power light indicates that you should charge Looj's battery.

- Detach the remote control handle.
- Press the remote control power button. The light on the remote control handle blinks when it is transmitting signals to the robot.
- If you press the left arrow of the auger spin direction button (A), debris will be thrown to the left. If you press the right side, it will be thrown to the right (B).

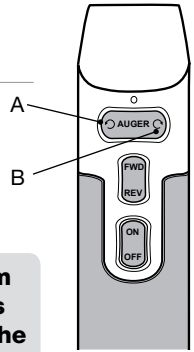

TIP: Note that one direction will spin the debris away from the house and the other direction will spin the debris onto the roof. Test the spin direction before driving the robot down the gutter.

- Ensure that the auger is spinning and tossing debris out of the gutter and away from your home.
- Press the forward and backward button to drive the robot through the gutter and remove the debris.

Handling Dense Clogs

Looj can handle most debris found in your gutter. Occasionally, there may be heavy debris that will not clear in a single pass. Should this situation arise, it's important not to force the robot into the debris.

TIP: If you hear a loud clicking sound and the auger stops spinning, the auger's clutch has slipped. Reverse Looj if this occurs. Once you are clear of the debris, proceed with your cleaning.

To handle heavy clogs, leave the auger on and drive the robot slowly forward until the auger contacts the clogged debris. Allow the auger to eject a small amount of debris. If Looj gets stuck or if the clutch slips, reverse direction and allow the auger to clear away the debris it has loosened. Repeat this process until the clogged debris is fully cleared.

⚠ CAUTION: If Looj begins to climb up over debris, STOP MOVING THE ROBOT forward and back it up. If you drive the robot over debris and up the side of the gutter, you risk it falling out of the gutter which may cause injury.

11. Once Looj reaches the end of the gutter, drive it back to you.
Keep the auger spinning to drive under the gutter straps

12. Turn the power switch off on the robot and turn the remote power off.

13. Attach the remote control handle to remove Looj from the gutter and clip Looj to the belt clip before descending.

14. Descend the ladder following safety instructions from ladder manufacturer.

Maintenance

Cleaning Looj

Make sure the battery door is securely closed before cleaning. Looj is designed to be easily cleaned with a hose or under a faucet. No chemicals should be used to clean Looj. Prior to cleaning, remove the remote control handle and treads from the robot. Clean any debris from Looj's wheels.

Looj's remote control handle should be cleaned with a damp cloth only. The remote control handle is not waterproof. Damage may occur to the electronics if it is sprayed with water or submerged.

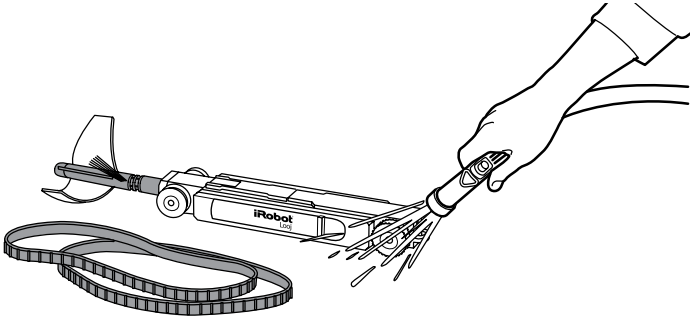

⚠ CAUTION: When the battery is removed, wipe inside of battery compartment door clean to ensure a proper seal.

⚠ CAUTION: Always keep the battery door closed when cleaning to avoid damage to the product or battery.

Storing Looj

Store iRobot Looj in a cool, dry place. After charging, store Looj and its battery between 50° and 80° F (10°-26° C). Excessive heat or cold may reduce battery life and product performance. For best results, we recommend removing both the battery from the robot and the batteries from the remote control handle when the product is stored.

Troubleshooting

Refer to the chart below to resolve Looj's problem. If the problem is not resolved, visit www.irobot.com/support (page 18).

Observation	Likely Cause	What to do
Remote transmission light does not light up on the remote.	Batteries were inserted incorrectly or have depleted. Power may not be on.	Check the battery orientation or replace with fresh batteries. Switch the remote power button to the "on" position.
Robot is not responding to the remote control handle.	Robot power is off or there is radio interference between the remote control handle and robot.	Check to see that both power buttons are on and both robot and remote control handle lights are flashing when a remote button is pressed. If not, try to improve reception by raising the remote control handle above the height of the gutter while operating.
Auger will not insert into robot.	Insertion hole is clogged.	Clean out hole with toothpick or forced air.
Auger stops spinning and loud clicking sound is heard.	Clutch has slipped on auger.	Turn off the auger and back up the robot away from any debris. Try spinning the auger in a clear area to test it.
Auger is spinning but robot is not moving.	Robot movement has stopped due to debris stuck in robot track.	Retrieve robot, clean the wheels and test it on the ground to make sure it is operating properly before placing back into the gutter.
Robot is stuck on gutterstrap.	Gutterstrap is too low or improperly installed.	Check gutterstrap for previously existing damage or improper installation. Looj fits under all standard 2 1/4" gutterstrap installations.

Improving the range of the remote control handle

Should you experience signal loss from the remote control handle to iRobot Looj while it is cleaning, touch the front of the handle to the gutter to maximize the range.

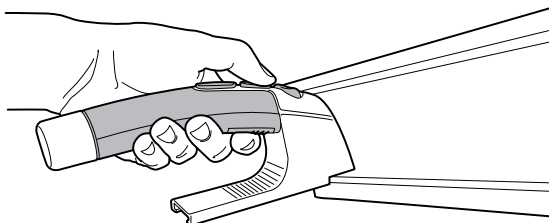

TIP: This works with aluminum and other metal gutters but not with vinyl or plastic gutters.

Indicator Lights

Robot Power Light	What it means
Solid Red	Battery is low. Turn off auger immediately and recharge battery.
Blinking Red	Battery is low and robot is receiving data (commands) from the remote. Turn off auger immediately and recharge battery.
Solid Green	Power is on, battery level is ok.
Blinking Green	Robot is receiving data (commands) from the remote control.

Remote Transmission Light	What it means
Solid Green	Power is on.
Blinking Green	Remote control is sending data (commands) to the robot.

iRobot Customer Care

If you have questions or comments about this product please contact iRobot before contacting a retailer.

Please visit **www.irobot.com** for support tips, frequently asked questions, or information about accessories and other iRobot products. We would like to hear from you.

Should you still need assistance:

- Visit the iRobot support site at **www.irobot.com/support**
- Call our customer care representatives at 877.855.8593

iRobot Customer Care Hours:

- Monday – Friday 9AM – 7PM Eastern Time
- Saturday 9AM – 6PM Eastern Time

Important Safety Instructions

**Looj is a gutter cleaning device, use only as intended.
For residential use only.**

READ ALL INSTRUCTIONS BEFORE USING LOOJ.

- This device has been tested and complies with FCC rules. Changes or modifications not expressly approved by the manufacturer will void your warranty.
- Always wear safety goggles when operating.
- Looj will be throwing material clear of the gutter. Keep yourself and others out of path of flying debris. Make sure debris path below the gutter is clear of property or objects.
- Always use the belt clip when carrying Looj, and keep both hands on the ladder while climbing and descending the ladder.
- Do not expose remote control handle to water.
- Robot is waterproof in up to one foot of water, do not submerge in deeper water.
- Do not expose the robot to water if battery door is not secured to prevent damage to Looj.
- Do not attempt to service Looj yourself. Refer all non-routine servicing to qualified service personnel. Visit **www.irobot.com/support** for more information.
- Looj is expressly not intended for children. Looj is not a toy. Do not sit or stand on this device. Small children and pets should be supervised if Looj is in use.
- Keep loose clothing, hair and body parts away from Looj while operating.
- Do not use this device near fire or high heat.
- Always remove the battery before long-term storage.
- Use only iRobot Looj batteries and chargers to charge this device.
- Charge using standard US (120V AC) outlet only. Do not use with any type of power converter — any such use will immediately void the warranty.
- Do not use the charger if the cord or plug is damaged.
- Charge indoors only.

⚠ IMPORTANT: Make sure you read and follow all safety instructions and labels from your ladder manufacturer before attempting to use Looj. Failure to do so may cause serious injury or death.

Ladder Safety

- iRobot Looj enables you to clean a single run of gutter with one ladder position. Choose the safest ladder position possible along each run. Safe ladder positions are away from power lines, tree limbs, or other hazards, and provide a level surface to rest the ladder.
- Always inspect the ladder before you use it. Never use the ladder if it is damaged, broken or bent.
- Make sure the ladder is away from electrical wires, tree limbs, doors, or any other hazards when it is extended.
- Do not lean over the side of the ladder when using Looj. Never over-reach. Keep yourself balanced and centered over the ladder at all times.
- Keep both feet and one hand firmly on the ladder while placing Looj in the gutter and operating Looj.
- Keep the handle on Looj when placing it in and removing it from the gutter.
- Do not place Looj in the gutter while standing on a roof unless you are secured to the roof with a safety harness in accordance with the manufacturer's instructions.

LIMITED WARRANTY TO ORIGINAL PURCHASER

*This iRobot brand product, as supplied and distributed by iRobot Corporation, and delivered as manufactured, in the carton to the original customer purchaser, is warranted by iRobot Corporation against manufacturing defects in materials and workmanship for the qualifying limited warranty period as follows: **One year LABOR AND PARTS:** This limited warranty begins on the original date of purchase, and is valid only on products purchased and used in North America, and does not include installation, removal or reinstallation. Warranty repairs must be performed by iRobot Corporation's authorized service center. To receive warranty service, the original dated bill of sale must be presented upon request as proof of purchase to iRobot Corporation's authorized service center. To obtain warranty service, support or other information, please visit our website at www.irobot.com or by calling 877-855-8593.*

iRobot Corporation will repair or replace this product, at our option and at no charge with new or reconditioned parts, if found to be defective during the limited warranty period specified above. To request service, the purchaser must contact iRobot Corporation for problem determination and service procedures. iRobot Corporation does not warrant uninterrupted or error-free operation of the product. All replaced parts and products become the property of iRobot Corporation and must be returned to iRobot. Replacement parts and products assume the remaining original warranty, or 60 days, whichever is longer. This limited warranty covers manufacturing defects in materials and workmanship encountered in normal, and, except to the extent otherwise expressly provided in this statement, non-commercial use of this product and shall not apply to the following, including but not limited to: damage which occurs in shipment; applications and uses for which this product was not intended; failures or problems which are caused by products or equipment not supplied by iRobot Corporation; accidents, misuse, abuse, neglect, misapplication, fire, water, lightning or other acts of nature; incorrect electrical line voltage, fluctuations or surges; damage caused by improper installation; product alteration or modification; improper or unauthorized repair; exterior finish or cosmetic damage; failure to follow operation instructions, customer adjustments, maintenance and environmental instructions that are covered and prescribed in the instruction book; use of non-iRobot or unauthorized parts, supplies, accessories or equipment which damage this product or result in service problems; failures or problems due to incompatibility with other equipment.

THERE ARE NO EXPRESS WARRANTIES OTHER THAN THOSE LISTED AND DESCRIBED ABOVE, AND NO WARRANTIES WHETHER EXPRESS OR IMPLIED, INCLUDING, BUT NOT LIMITED TO, ANY IMPLIED WARRANTIES OF MERCHANTABILITY OR FITNESS FOR A PARTICULAR PURPOSE, SHALL APPLY AFTER THE EXPRESS WARRANTY PERIOD STATED ABOVE, AND NO OTHER EXPRESS WARRANTY OR GUARANTY GIVEN BY ANY PERSON, FIRM OR CORPORATION WITH RESPECT TO THIS PRODUCT SHALL BE BINDING ON IROBOT CORPORATION. IROBOT CORPORATION SHALL NOT BE LIABLE FOR LOSS OF REVENUE OR PROFITS, FAILURE TO REALIZE SAVINGS OR OTHER BENEFITS, OR ANY OTHER SPECIAL, INCIDENTAL OR CONSEQUENTIAL DAMAGES CAUSED BY THE USE, MISUSE OR INABILITY TO USE THIS PRODUCT, REGARDLESS OF THE LEGAL THEORY ON WHICH THE CLAIM IS BASED, AND EVEN IF IROBOT HAS BEEN ADVISED OF THE POSSIBILITY OF SUCH DAMAGES. NOR SHALL RECOVERY OF ANY KIND AGAINST IROBOT CORPORATION BE GREATER IN AMOUNT THAN THE PURCHASE PRICE OF THE PRODUCT SOLD BY IROBOT CORPORATION AND CAUSING THE ALLEGED DAMAGE. WITHOUT LIMITING THE FOREGOING, PURCHASER ASSUMES ALL RISK AND LIABILITY FOR LOSS, DAMAGE OR INJURY TO PURCHASER AND PURCHASER'S PROPERTY AND TO OTHERS AND THEIR PROPERTY ARISING OUT OF THE USE, MISUSE OR INABILITY TO USE THIS PRODUCT SOLD BY IROBOT CORPORATION NOT CAUSED DIRECTLY BY THE GROSS NEGLIGENCE OF IROBOT CORPORATION. THIS LIMITED WARRANTY SHALL NOT EXTEND TO ANYONE OTHER THAN THE ORIGINAL PURCHASER OF THIS PRODUCT, IS NONTRANSFERABLE AND STATES YOUR EXCLUSIVE REMEDY.

Some states do not allow limitations on how long an implied warranty lasts, or the exclusion or limitation of incidental or consequential damages, so the above limitations or exclusions may not apply to you. This warranty gives you specific legal rights and you may also have other rights which vary from state to state.

FCC Notice: This equipment has been tested and found to comply with the limits for a Class B digital device, pursuant to Part 15 of the FCC Rules. These limits are designed to provide reasonable protection against harmful interference in a residential installation. This equipment generates uses and can radiate radio frequency energy and, if not installed and used in accordance with the instructions, may cause harmful interference to radio communications. However, there is no guarantee that interference will not occur in a particular installation. If this equipment does cause harmful interference to radio or television reception, which can be determined by turning the equipment off and on, the user is encouraged to try to correct the interference by one or more of the following measures:

- Reorient or relocate the receiving antenna.
- Increase the separation between the equipment and receiver.
- Connect the equipment into an outlet on a circuit different from that to which the receiver is connected.
- Consult the manufacturer, dealer, or an experienced radio/TV technician for help.

⚠ WARNING: Changes or modifications not expressly approved by iRobot could void your warranty.

Get iRobot accessories at:
800.727.9077 or visit **store.irobot.com**

iRobot®

© 2008 iRobot Corporation, 8 Crosby Drive, Bedford, MA 01730. All rights reserved.
iRobot is a registered trademark of iRobot Corporation. Looj is a trademark of iRobot Corporation.
Patents Pending