

BUNN[®] My Café[®] MCO



INSTALLATION & OPERATING GUIDE

BUNN-O-MATIC CORPORATION

POST OFFICE BOX 3227

SPRINGFIELD, ILLINOIS 62708-3227

PHONE: (217) 529-6601 FAX: (217) 529-6644

To ensure you have the latest revision of the Operating Manual, or to view the Illustrated Parts Catalog, Programming Manual, or Service Manual, please visit the Bunn-O-Matic website, at www.bunn.com. This is absolutely FREE, and the quickest way to obtain the latest catalog and manual updates. For Technical Service, contact Bunn-O-Matic Corporation at 1-800-286-6070.

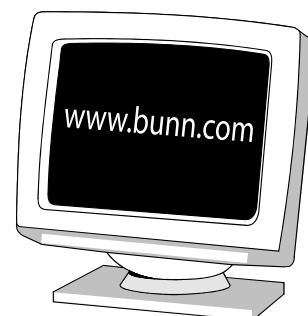

49251.0000A 07/14 ©2014 Bunn-O-Matic Corporation

DIR Num: 49251.0000

08, July 2014

BUNN-O-MATIC COMMERCIAL PRODUCT WARRANTY

Bunn-O-Matic Corp. ("BUNN") warrants equipment manufactured by it as follows:

- 1) Airpots, thermal carafes, decanters, GPR servers, iced tea/coffee dispensers, MCR/MCP/MCA single cup brewers, thermal servers and ThermoFresh® servers (mechanical and digital) 1 year parts and 1 year labor.
- 2) All other equipment - 2 years parts and 1 year labor plus added warranties as specified below:
 - a) Electronic circuit and/or control boards - parts and labor for 3 years.
 - b) Compressors on refrigeration equipment - 5 years parts and 1 year labor.
 - c) Grinding burrs on coffee grinding equipment to grind coffee to meet original factory screen sieve analysis - parts and labor for 4 years or 40,000 pounds of coffee, whichever comes first.

These warranty periods run from the date of installation BUNN warrants that the equipment manufactured by it will be commercially free of defects in material and workmanship existing at the time of manufacture and appearing within the applicable warranty period. This warranty does not apply to any equipment, component or part that was not manufactured by BUNN or that, in BUNN's judgment, has been affected by misuse, neglect, alteration, improper installation or operation, improper maintenance or repair, non periodic cleaning and descaling, equipment failures related to poor water quality, damage or casualty. In addition, the warranty does not apply to replacement of items subject to normal use including but not limited to user replaceable parts such as seals and gaskets. This warranty is conditioned on the Buyer 1) giving BUNN prompt notice of any claim to be made under this warranty by telephone at (217) 529-6601 or by writing to Post Office Box 3227, Springfield, Illinois 62708-3227; 2) if requested by BUNN, shipping the defective equipment prepaid to an authorized BUNN service location; and 3) receiving prior authorization from BUNN that the defective equipment is under warranty.

THE FOREGOING WARRANTY IS EXCLUSIVE AND IS IN LIEU OF ANY OTHER WARRANTY, WRITTEN OR ORAL, EXPRESS OR IMPLIED, INCLUDING, BUT NOT LIMITED TO, ANY IMPLIED WARRANTY OF EITHER MERCHANTABILITY OR FITNESS FOR A PARTICULAR PURPOSE. The agents, dealers or employees of BUNN are not authorized to make modifications to this warranty or to make additional warranties that are binding on BUNN. Accordingly, statements by such individuals, whether oral or written, do not constitute warranties and should not be relied upon.

If BUNN determines in its sole discretion that the equipment does not conform to the warranty, BUNN, at its exclusive option while the equipment is under warranty, shall either 1) provide at no charge replacement parts and/or labor (during the applicable parts and labor warranty periods specified above) to repair the defective components, provided that this repair is done by a BUNN Authorized Service Representative; or 2) shall replace the equipment or refund the purchase price for the equipment.

THE BUYER'S REMEDY AGAINST BUNN FOR THE BREACH OF ANY OBLIGATION ARISING OUT OF THE SALE OF THIS EQUIPMENT, WHETHER DERIVED FROM WARRANTY OR OTHERWISE, SHALL BE LIMITED, AT BUNN'S SOLE OPTION AS SPECIFIED HEREIN, TO REPAIR, REPLACEMENT OR REFUND.

In no event shall BUNN be liable for any other damage or loss, including, but not limited to, lost profits, lost sales, loss of use of equipment, claims of Buyer's customers, cost of capital, cost of down time, cost of substitute equipment, facilities or services, or any other special, incidental or consequential damages.

392, A Partner You Can Count On, Air Infusion, AutoPOD, AXIOM, BrewLOGIC, BrewMETER, Brew Better Not Bitter, BrewWISE, BrewWIZARD, BUNN Espresso, BUNN Family Gourmet, BUNN Gourmet, BUNN Pour-O-Matic, BUNN, BUNN with the stylized red line, BUNNlink, Bunn-O-Matic, Bunn-O-Matic, BUNNserve, BUNNSERVE with the stylized wrench design, Cool Froth, DBC, Dr. Brew stylized Dr. design, Dual, Easy Pour, EasyClear, EasyGard, FlavorGard, Gourmet Ice, Gourmet Juice, High Intensity, iMIX, Infusion Series, Intellisteam, My Café, Phase Brew, PowerLogic, Quality Beverage Equipment Worldwide, Respect Earth, Respect Earth with the stylized leaf and coffee cherry design, Safety-Fresh, savemycoffee.com, Scale-Pro, Silver Series, Single, Smart Funnel, Smart Hopper, SmartWAVE, Soft Heat, SplashGard, The Mark of Quality in Beverage Equipment Worldwide, ThermoFresh, Titan, trifacta, TRIFECTA (stylized logo), Velocity Brew, Air Brew, Beverage Bar Creator, Beverage Profit Calculator, Brew better, not bitter., Build-A-Drink, BUNNsource, Coffee At Its Best, Cyclonic Heating System, Daypart, Digital Brewer Control, Element, Milk Texturing Fusion, Nothing Brews Like a BUNN, Picture Prompted Cleaning, Pouring Profits, Signature Series, Sure Tamp, Tea At Its Best, The Horizontal Red Line, Ultra are either trademarks or registered trademarks of Bunn-O-Matic Corporation. The commercial trifacta® brewer housing configuration is a trademark of Bunn-O-Matic Corporation.

CONTENTS

Warranty	2
Introduction	3
User Notices	3
Electrical Requirements	4
Plumbing Requirements	5
Initial Setup.....	5
Brewing Instructions.....	7
Cleaning	8
Tank Draining.....	8
Programming	9
Time/Date, Language, Advanced	10
Password, Units, Drink Set Up.....	11
Machine Settings:	
Drink, Water, General, Energy Saver	12
Service Tools:	
Import/Export.....	13
Calibrate Volume.....	14
Calibrate Temperature & Refill, Diagnostics.....	15
Factory Defaults.....	16

INTRODUCTION

This equipment is factory set to brew approximately 6-8 ounces of coffee or tea into an awaiting dispenser. It is only for indoor use on a sturdy counter or shelf. Replace any unreadable or damaged labels.

USER NOTICES

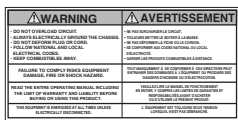

#00986.7000

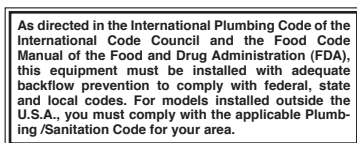

#00656.0001

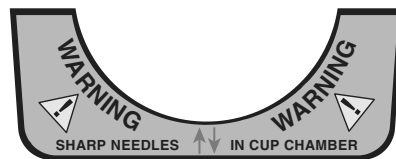

#49867.0000



#37280.0001



#00824.0002



#37881.7002

ELECTRICAL REQUIREMENTS

CAUTION - The brewer must be disconnected from the power source until specified in *Initial Set-Up*.

Refer to Data Plate on the Brewer, and local/national electrical codes to determine circuit requirements.



120 VOLT Model

Note: This electrical service consists of 2 current carrying conductors (L1 and Neutral) and a separate conductor for chassis ground.

Electrical Hook-Up

CAUTION – Improper electrical installation will damage electronic components.

1. An electrician must provide electrical service as specified.
2. Using a voltmeter, check the voltage and color coding of each conductor at the electrical source.
3. If plumbing is to be hooked up later be sure the brewer is disconnected from the power source. If plumbing has been hooked up, the brewer is ready for Initial Set-Up.

PLUMBING REQUIREMENTS

These brewers must be connected to a cold water system with operating pressure between 20 and 90 psi (138 and 620 kPa) from a ½" or larger supply line. A shut-off valve should be installed in the line before the brewer. Install a regulator in the line when pressure is greater than 90 psi (620 kPa) to reduce it to 50 psi (345 kPa). The water inlet fitting is .75-11.5 NH (HOSE THREAD). For convenience an elbow adaptor is provided to convert to a ¼" flare fitting. Bunn-O-Matic does not recommend the use of a reverse-osmosis or deionized water supply to this equipment.

NOTE - Bunn-O-Matic recommends ¼" copper tubing for installations of less than 25 feet and ⅜" for more than 25 feet from the ½" water supply line. A tight coil of tubing in the water line will facilitate moving the brewer to clean the countertop. Bunn-O-Matic does not recommend the use of a saddle valve to install the brewer. The size and shape of the hole made in the supply line by this type of device may restrict water flow.

As directed in the International Plumbing Code of the International Code Council and the Food Code Manual of the Food and Drug Administration (FDA), this equipment must be installed with adequate backflow prevention to comply with federal, state and local codes. For models installed outside the U.S.A., you must comply with the applicable Plumbing /Sanitation Code for your area.

NOTE - If a backflow preventer is required by code, a shock arrestor should be installed between backflow preventer and dispenser. Installing the shock arrestor as close to the dispenser as possible will provide the best results.

Plumbing Hook-Up

1. Flush the water line.
2. Securely attach the adaptor elbow assembly to the ¼" flare fitting on water supply line.
3. Securely attach adaptor elbow assembly to the the .75-11.5 NH fitting at the rear of the brewer.
4. Turn on the water supply.

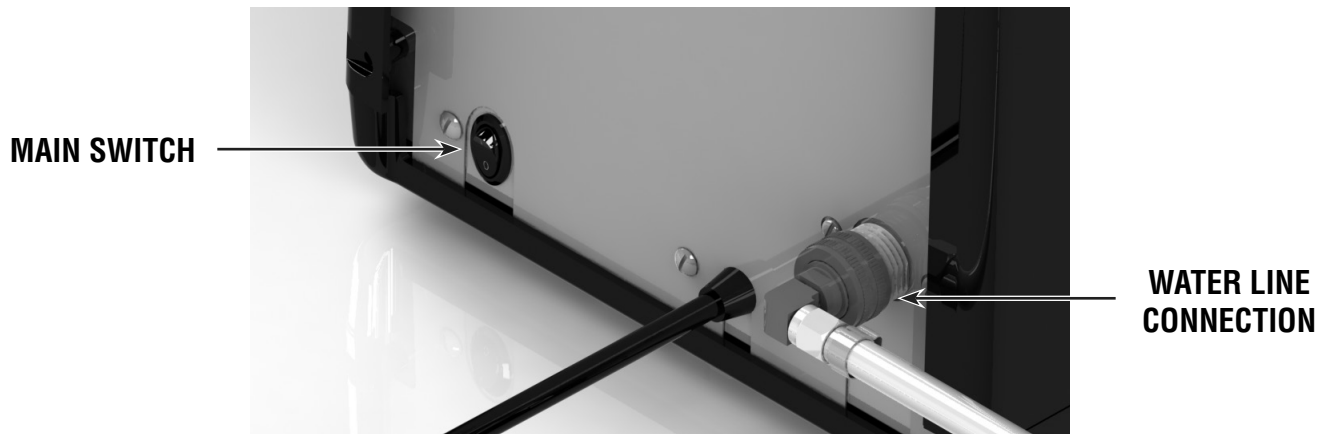

INITIAL SET-UP

1. Connect to power source.
2. Turn on main switch.
3. Wait approximately ten minutes for the tank to fill and heat. The display will read "READY TO BREW" when tank reaches it's operating temperature.

The brewer is now ready for use in accordance with the instructions for Coffee Brewing.

BREWING INSTRUCTIONS

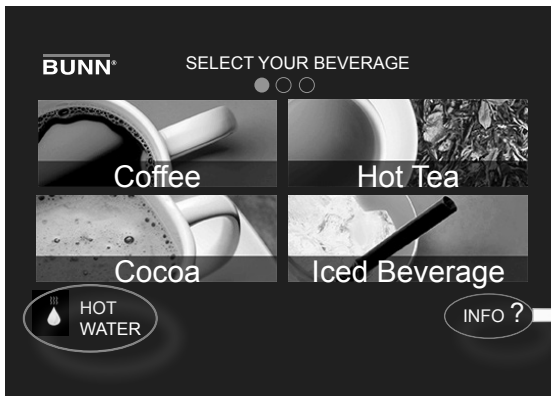

Press picture to select beverage type.
Press & hold "Hot Water" icon to dispense up to 10 ounces of hot water

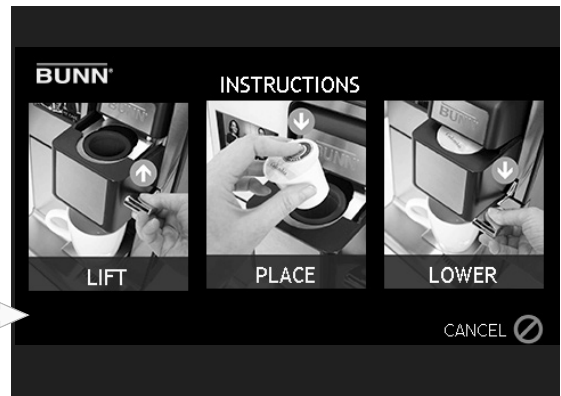

Press "INFO?" icon to access this instruction screen. Follow screen to lift handle, place cartridge in basket and lower handle.

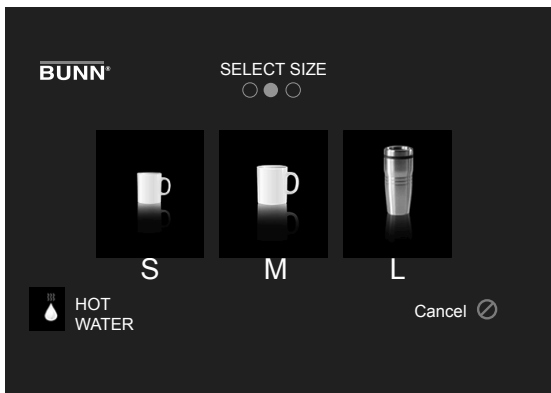

Press to select small, medium or large.
(Lifting handle in this screen will go back to "INFO" screen)

NOTE: This screen *may not be displayed* if some selections have been disabled in "Advanced Programming".

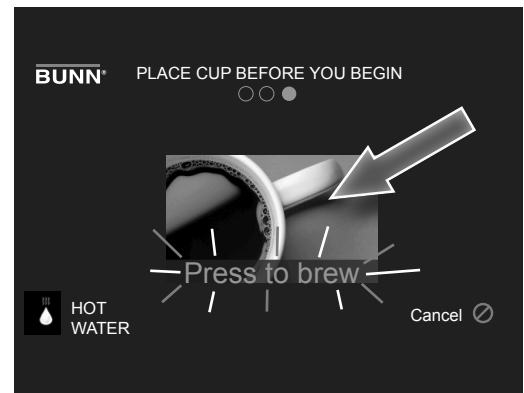

Place appropriate sized cup under brew chamber.
Press the picture to start.
(Alternates between green and white)

NOTE: Screen shots shown above are typical examples, not all screens and scenarios are depicted.

NOTE: Water volumes and flow settings have been preset at the factory. Refer to "PROGRAMMING" section of this manual for the "DRINK SETUP SCREEN", should the volume need to be increased or decreased.

CLEANING

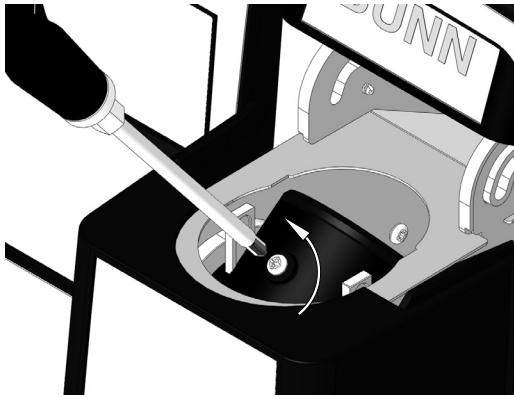

BASKET HOLDER

1. Disconnect brewer from power source and allow to cool.
2. Raise lever to access the basket holder.
3. Tilt basket back and loosen screw a few turns.
4. Tilt forward and lift basket out.
5. Wash and rinse basket. Verify holes are cleared.

CAUTION: BASKET CONTAINS A SHARP NEEDLE.

6. Install basket back into holder, carefully snug screw back in.

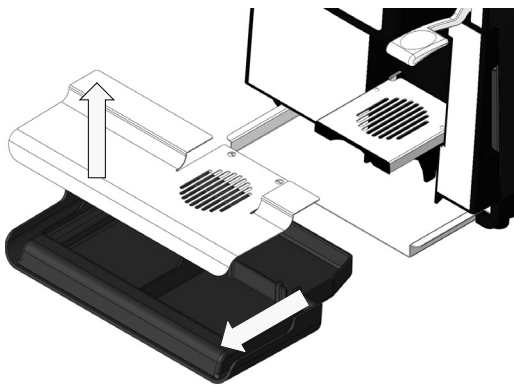

DRIP TRAY

1. Pull the drip tray out.
2. Lift the drip tray cover up.

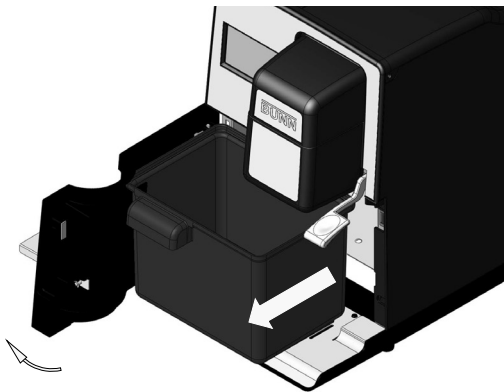

CARTRIDGE BIN

1. Open front door.
2. Slide bin forward.
3. Empty as needed.

The use of a damp cloth rinsed in any mild, nonabrasive, liquid detergent is recommended for cleaning exterior surfaces except display screen. To clean display screen, turn off power and use a soft damp cloth with no chemicals.

TANK DRAINING

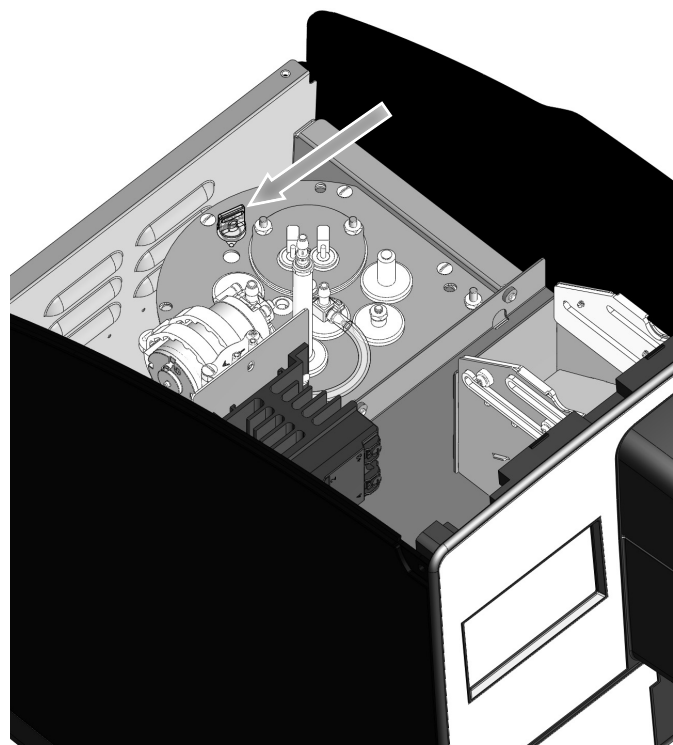
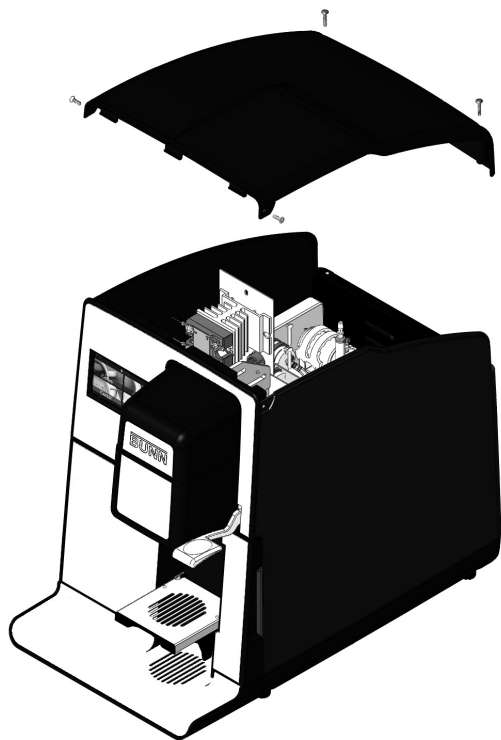

TANK DRAINING

1. Disconnect the power and water supply to brewer. Allow brewer to cool before proceeding.
2. Remove 4 screws and the top cover.

3. Remove plug from tank lid.
4. Place brewer next to a sink.

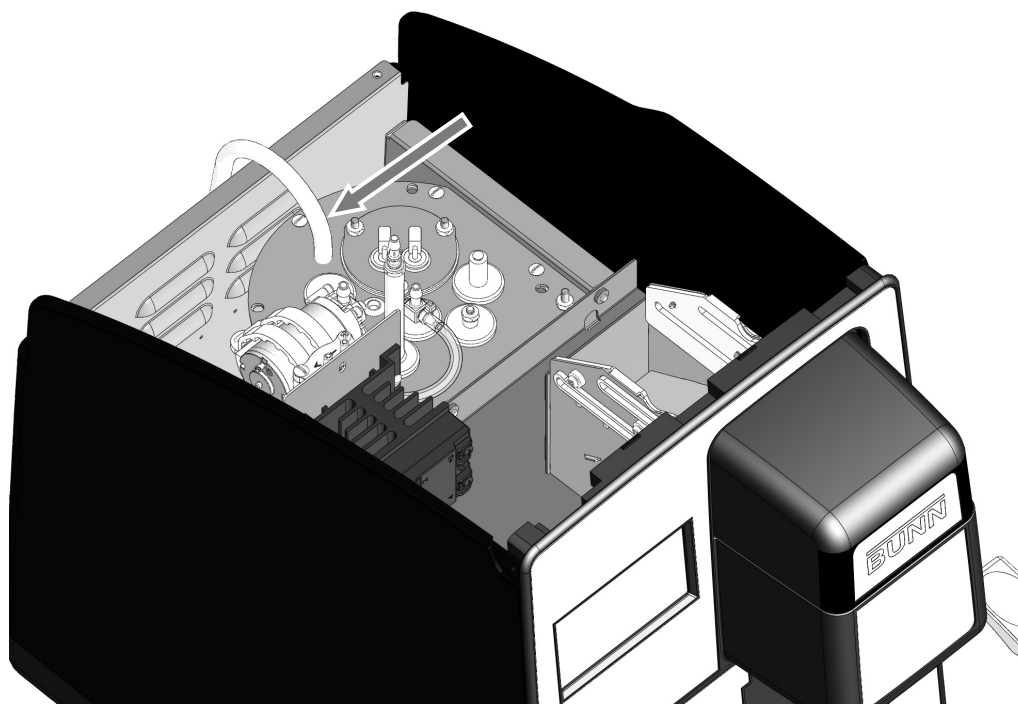

5. Insert a syphon hose through the unplugged hole to syphon water out of tank.

PROGRAMMING

Programming lockout switch

1. Disconnect brewer from power source.
2. Remove four screws and top cover.
3. Locate the slide switch on control board (behind display assembly).
Down=normal, up=locked.

NOTE: When locked, only "time and date" can be changed, all other screens will display "**READ ONLY**".

NOTE: Brewer **MUST** be powered down each time switch is moved in order for the change to take effect.

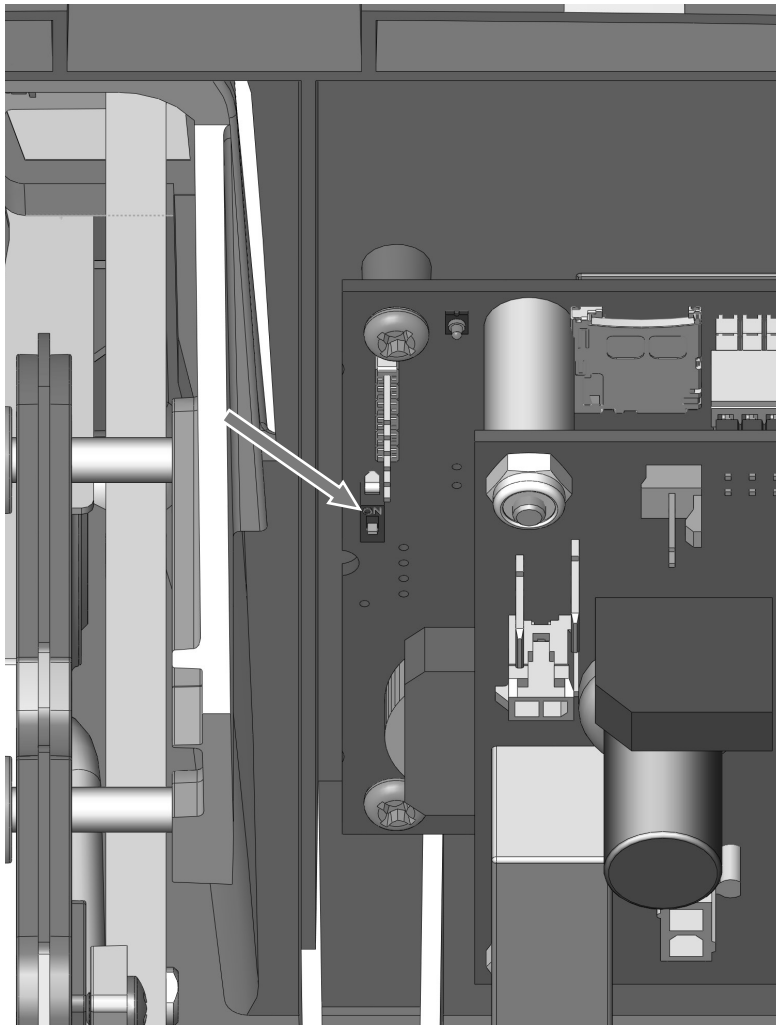

PROGRAMMING

Time/Date, Language, Advanced

Press "BUNN" logo until the program screen appears (below)

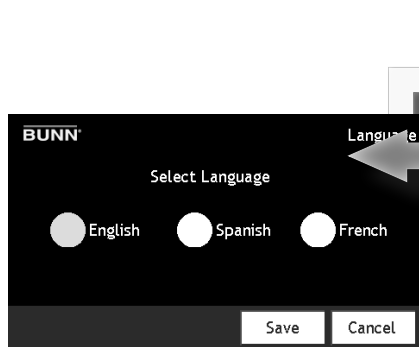
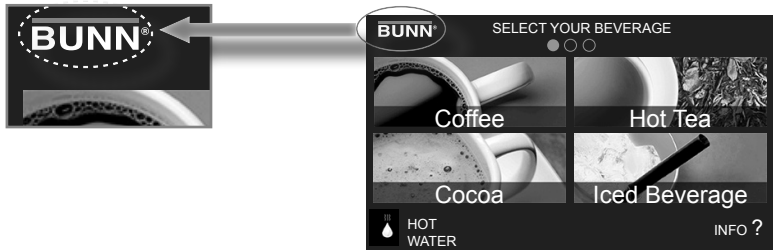

Select language, press "Save"

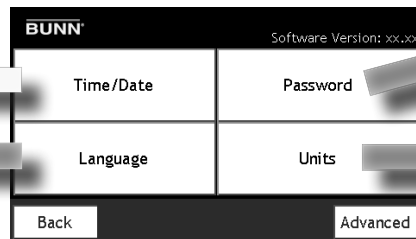

Press "Advanced" to enter programming screens

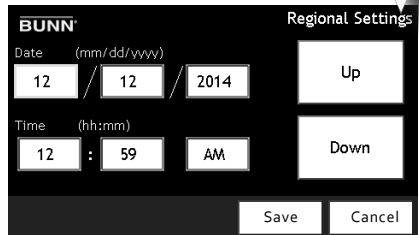

Press to highlight desired box, then press "Up" or "Down" to adjust. Press "Save" when finished.

BUNN	Lifetime			Drink History Current		
	S	M	L	S	M	L
Coffee	00000	00000	00000	00000	00000	00000
Hot Tea	00000	00000	00000	00000	00000	00000
Cocoa	00000	00000	00000	00000	00000	00000
Iced Beverage	00000	00000	00000	00000	00000	00000
Total	00000	00000	00000	00000	00000	00000
	Grand Total		00000			00000

User can reset "Current" counts, but not "Lifetime" counters

NOTE: Keypad will not be displayed if no password has been set

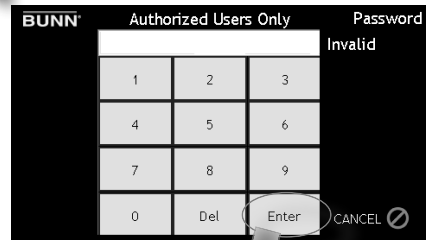

Enter four digit "password"
Press "Enter"

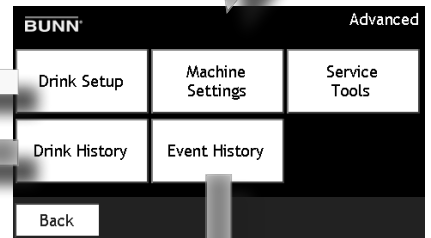

BUNN	Occurrences
Brew Head Switch Actuations	00000
Water Pump Stall	00000
Water Pump Error	00000
Flow Meter Error	00000

View events/error messages

Page 11

PROGRAMMING

Password, Units, Drink Set Up

Password

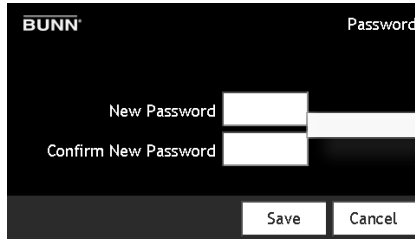

Press "Save" when finished

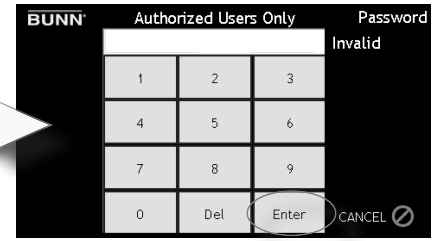

Enter four digit "password"
Press "Enter" when finished

Units

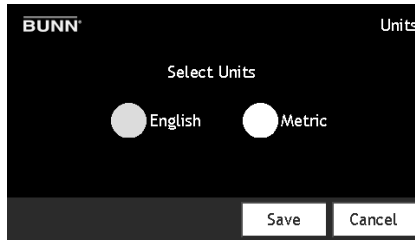

Select "English" or "Metric".
Press "Save" when finished

Drink Set Up

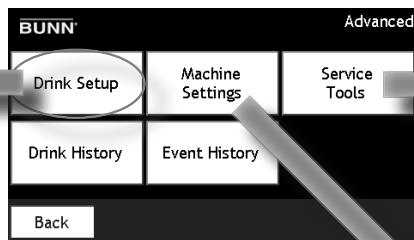

See page 13

See page 12

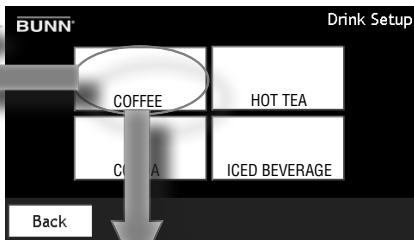

Select desired drink to access setup screen

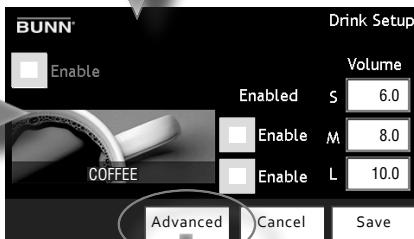

Here you can enable/disable by pressing the green box(s). Pressing white box (left side) will enable/disable the "COFFEE" icon (in previous screen). Pressing white box(s) under volume will display keypad to adjust ounces. *Green box indicates selection is enabled.*
4-16 oz. in .1 oz increments.
Defaults: 6, 8, 10 oz.

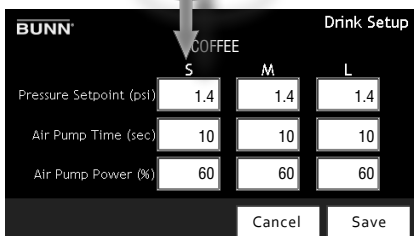

Use advanced setup screen to adjust pump pressure and times. Lower pressure will increase brew times, higher pressure will decrease brew times. **FOR TRAINED TECHNICIANS ONLY!**

	RANGE	Defaults
Pressure Set Point (PSI):	.5-2.5	1.4
Air Pump Time (SEC):	1-60	10.0
Air Pump Power (%):	10-80	60.0

PROGRAMMING

MACHINE SETTINGS:

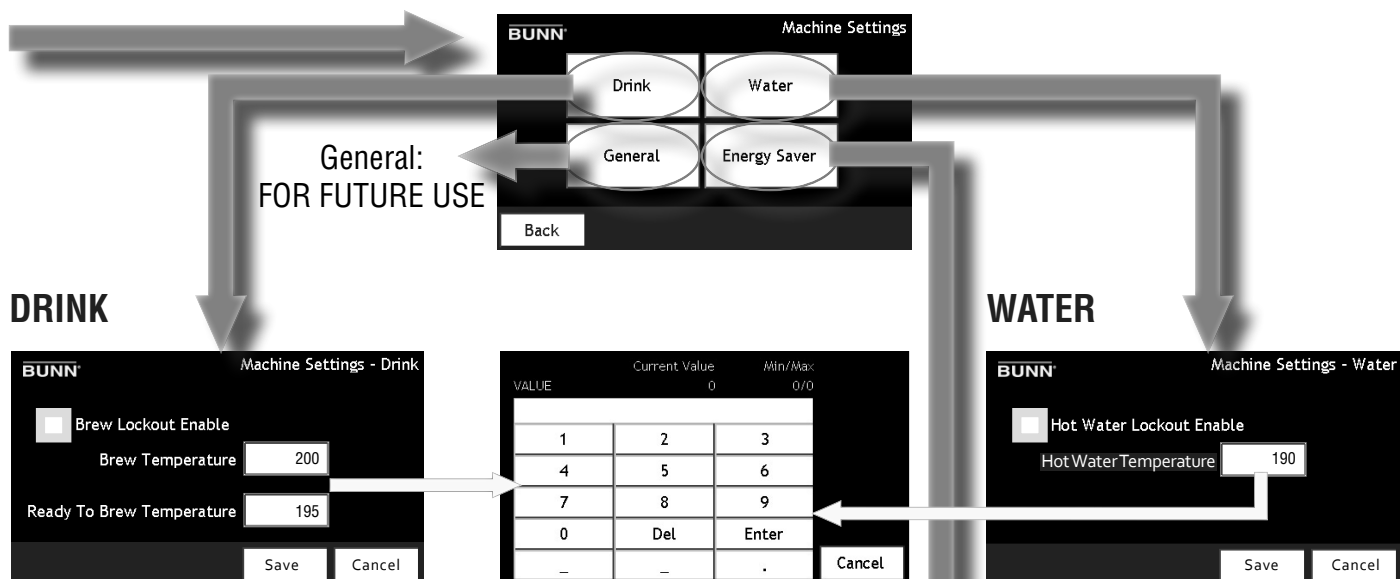

DRINK

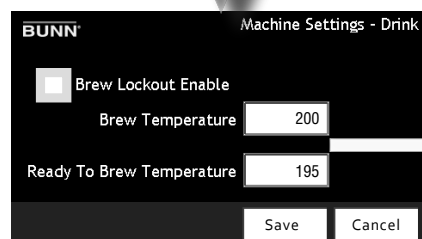

Here you can enable/disable the brew lockout feature. *Green box indicates selection is enabled and will not brew until temperature reaches the set value.*

Pressing the white temperature box(s) will display the keypad screen.

180-205°F in 1°increments.

Defaults: Enabled/200°F/195°F.

WATER

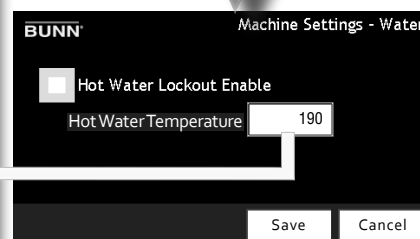

Here you can enable/disable the Hot Water lockout feature. *Green box indicates selection is enabled and hot water will not be dispensed when temperature is below the set value.*

Pressing the white box(s) will display the keypad screen.

180-200°F in 1°increments. Defaults: Enabled/190°F.

ENERGY SAVER

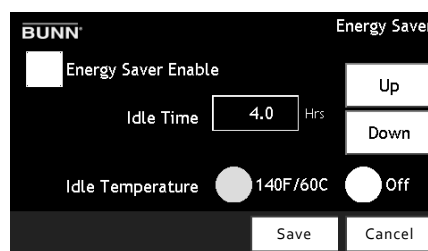

Press the "Up" or "Down" buttons to adjust time.

Here you can enable/disable the energy saver feature. *Green box indicates selection is enabled.*

.5-24 hours in 30 minute increments. Choice of dropping to 140°F/60°C or "OFF".

Defaults: Disabled.

PROGRAMMING

SERVICE TOOLS:

IMPORT/EXPORT

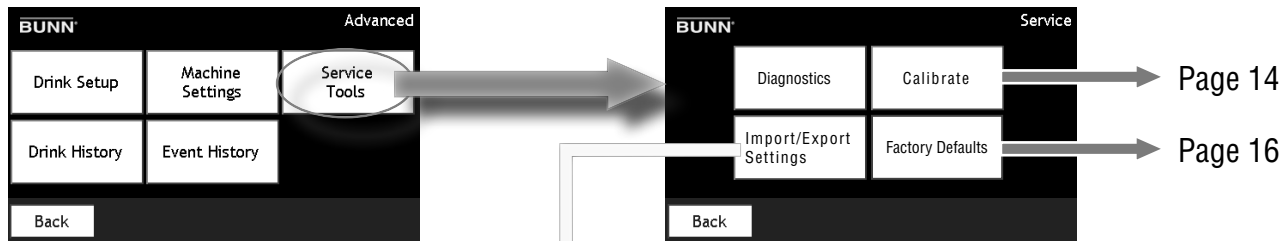

IMPORT/EXPORT

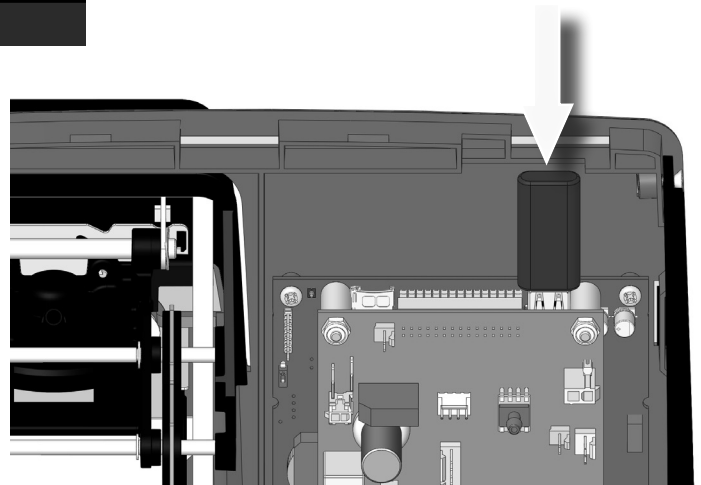
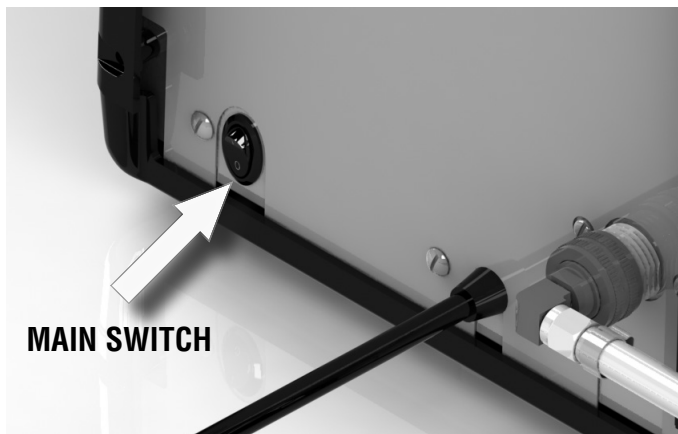
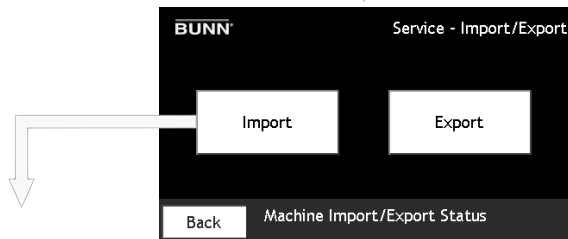

To Import drink/machine settings:

1. Turn off the power switch.

1. Carefully insert USB flash drive into socket. **NOTE:** *Make sure no other files are stored on drive other than what you are updating.*
2. Turn on power switch. Go to Import/Export screen. Press "Import". Allow files to finish loading.
3. Turn off the power switch.
4. Remove USB drive.
5. Re-install 4 screws and the top cover.
6. Turn on power switch.

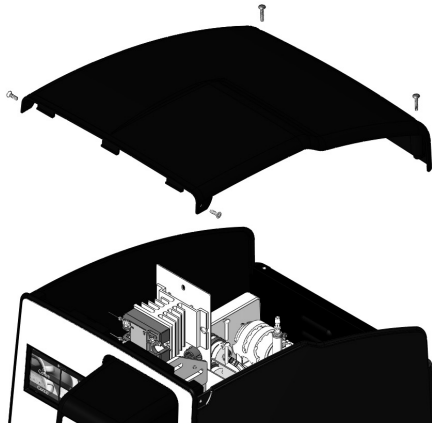

2. Remove 4 screws and the top cover.

To export machine settings:

1. Follow same procedures as above, except press "Export" to copy drink/machine settings to the flash drive.

PROGRAMMING

SERVICE TOOLS:

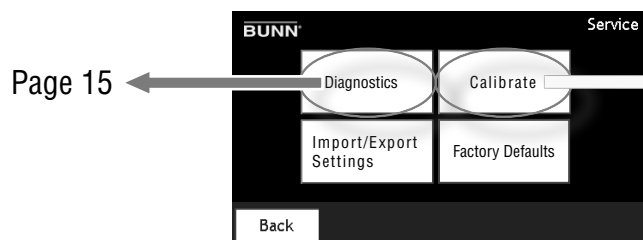

Page 15

VOLUME:

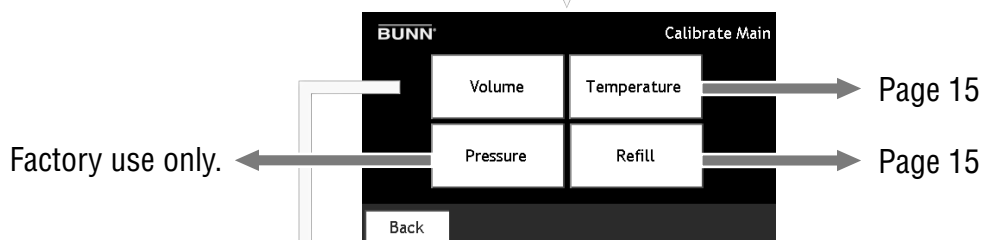

Factory use only.

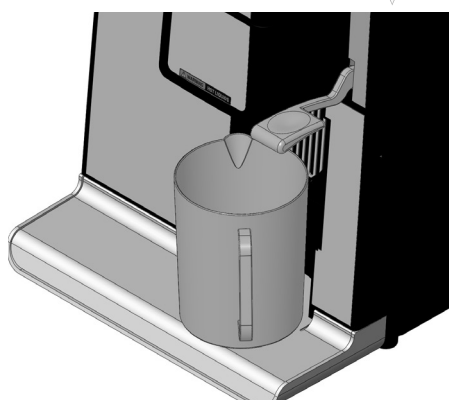

Weigh an empty 12 ounce or larger container. Place empty container under brew chamber.



CAUTION: HOT LIQUID WILL BE DISPENSED!
 Press start. When cycle finishes, weigh filled container. Subtract first measure from second to get the net weight of water. Repeat procedure at least three times to get an average "volume". Press the white "Volume Dispensed" box. Enter in the averaged weighed volume. Press enter. Press "Save" to retain the new setting.



Enter the new value. When finished, Press "Enter" then "Save".
 Verify/adjust cup volumes if needed.

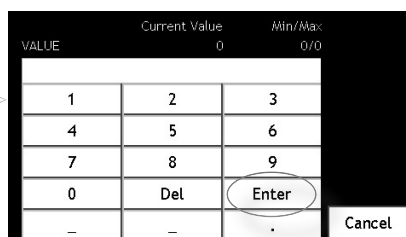

PROGRAMMING

SERVICE TOOLS:

FOR TRAINED TECHNICIANS ONLY!

CALIBRATE TANK TEMPERATURE

BUNN		Temperature	
Uncalibrated Temperature	<input type="text" value="199.0"/>	F	
Temperature Offset	<input type="text" value="1.0"/>	F	
Calibrated Temperature	<input type="text" value="200.0"/>	F	
Measured Temperature	<input type="text" value="200.0"/>	F	
		<input type="button" value="Save"/>	<input type="button" value="Cancel"/>

Insert a known accurate temperature sensing probe/device through the tank lid plug to a depth of 6 inches. Enter the "Measured temperature" in the white box. The "Un-calibrated Temperature" should be the old reading. "Calibrated Temperature" should be equal to the measured temperature. "Temperature Offset" should be the difference between the two.

CALIBRATE REFILL SENSITIVITY

BUNN		Refill	
Refill Status	<input type="text" value="Filled"/>		
Current Refill Value	<input type="text" value="520"/>		
New Refill Value	<input type="text" value="825"/>		
		<input type="button" value="Save"/>	<input type="button" value="Cancel"/>

Adjust sensitivity of refill probe according to water quality. Always make sure that the "Status" is filled. "New Refill Value" should always be higher than "Current Refill Value" when water is contacting the tank refill probe.

DIAGNOSTICS

BUNN		Diagnostics	
Tank Heater	<input type="button" value="Off"/>	Air Pump	<input type="button" value="Off"/>
TankTemp F		Flow Count	Unknown
Water Inlet Valve	<input type="button" value="Off"/>	Refill	Unknown
Water Pump	<input type="button" value="Off"/>	Pressure	X99.99 PSI
<input type="button" value="Back"/>		<input type="button" value="Next"/>	

These two screens allow you to manually operate various machine components for testing purposes. All are defaulted to "Off" and may be momentarily turned on by pressing the associated white box next to it.

BUNN		Diagnostics	
Hot Water	<input type="button" value="Off"/>	Brew Head Switch	Unknown
Air Pump		Bin Full Sensor	Unknown
Vent Valve	<input type="button" value="Off"/>	Display Board ID	Unknown
		I/O Board ID	Unknown
<input type="button" value="Back"/>			

FACTORY DEFAULTS

BE SURE THIS IS WHAT YOU WANT TO DO BEFORE YOU START!

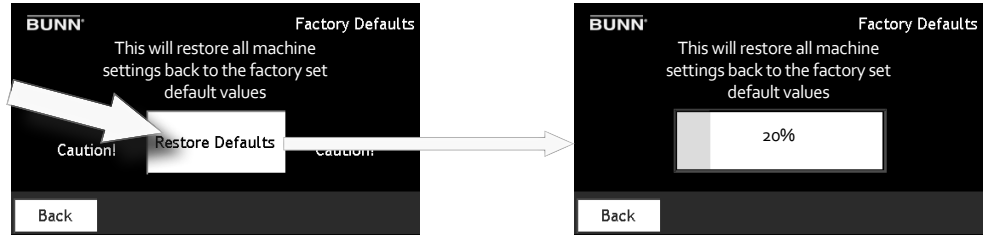

3. Carefully insert USB flash drive into socket. **NOTE:** Make sure no other files are stored on drive other than what you are updating.
4. Turn on power switch. Go to Import/Export screen. Press "Import". Allow files to finish loading.
5. Turn off the power switch.
6. Remove USB drive.
7. Re-install 4 screws and the top cover.
8. Turn on power switch.

NOTE: Resetting to factory defaults will reset drink settings, current history, language, units, and password. It will not reset calibrations or clear life counter.

DEFAULT VALUES

machine settings				
Parameter Name	Default Value	Min	Max	Notes
Brew Lockout Enable	Enabled			Enabled/Disabled
Brew Temperature (Set Point)	200	190	205	This value affects the maximum ready to brew temperature
Ready To Brew Temperature	195	180	200	Required to be at least 5 degrees below the set point
Hot Water Lockout	Enabled			Enabled/Disabled
Hot Water Temperature (Ready)	190	180	200	Required to be at least 5 degrees below the set point
Energy Saver Enable	Disabled			Enabled/Disabled
Energy Saver Idle Temperature	140F/60C			Options are set to "140F/60C" or heater "Off"
Energy Saver Idle Time	4 hours	30 min	24 hours	Moves in 30 minute increments within the range
Select Units	English			Options are "English" or "Metric"
Language	English			Options are "English", "Spanish", or "French"
Password	0	0	9999	Setting password to "0" will disable it
drink settings (per each drink)				
Parameter Name	Default Value	Min	Max	Notes
Drink Enable	Enabled			Enabled/Disabled
Medium Size Enable	Enabled			Enabled/Disabled
Large Size Enable	Enabled			Enabled/Disabled
Small Volume	6.0	4.0	16.0	Ounces Of Water
Medium Volume	8.0	4.0	16.0	Ounces Of Water
Large Volume	10.0	4.0	16.0	Ounces Of Water
Pressure Setpoint (PSI)	1.4	0.5	2.5	Small, Medium, Large are individually settable
Air Pump Time (sec)	10	1	60	Small, Medium, Large are individually settable
Air Pump Power (%)	60	10	80	Small, Medium, Large are individually settable
calibrations				
Parameter Name	Default Value	Min	Max	Notes
Calibrate Volume - Volume Dispensed	10.7	6.0	16.0	Flow Meter Calibration
Calibrate Temperature - Measured Temperature	0.0	180.0	205.0	Measured temperature must be within 10 degrees of the Uncalibrated Temperature to be valid, even within the min / max. Starts out with no calibration given (and thus no offset).
Calibrate Pressure - Low Calibration ADC	415	100	900	
Calibrate Pressure - High Calibration ADC	540	100	900	
Calibrate Pressure - Calibration Range	1.0	1.0	5.0	Calibration PSI
Calibrate Refill - New Refill Value	825	100	1023	