

PORTABLE AIR CONDITIONER

OWNER'S MANUAL

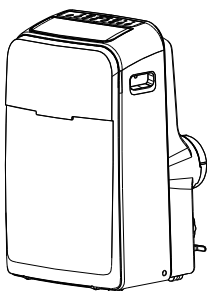
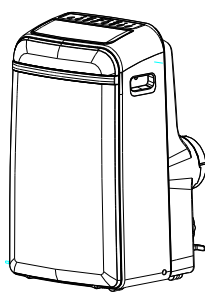
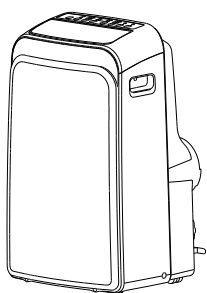

Inside you will find many helpful hints on how to use and maintain your air conditioner properly. Just a little preventative care on your part can save you a great deal of time and money over the life of your air conditioner. Before operating this product, please read the instructions carefully and save this manual for future use.

CONTENTS

SOCIABLE REMARK

Sociable remark.....	2
----------------------	---

SAFETY PRECAUTIONS

Safety rules	3
Operating condition	3
Electrical information	4

IDENTIFICATION OF PARTS

Accessories	4
Names of parts.....	5

AIR CONDITIONER FEATURES

Electronic control operating instructions	6
---	---

OPERATING INSTRUCTIONS

Operating instructions	7
------------------------------	---

INSTALLATION INSTRUCTIONS

Location	9
Window kit installation	9
Exhaust hose installation	12
Water drainage	13

CARE AND MAINTENANCE

Care and maintenance	14
----------------------------	----

TROUBLESHOOTING TIPS

Trouble shooting	15
------------------------	----

NOTE

The rating data indicated on the energy label is based on the testing condition of installing the un-extended air exhaust duct without adaptor A & B (The duct and the adaptor A & B are listed in the accessories chart of the Instruction Manual).

When using this air conditioner in the European countries, the following information must be followed:

DISPOSAL: Do not dispose this product as unsorted municipal waste. Collection of such waste separately for special treatment is necessary.

It is prohibited to dispose of this appliance in domestic household waste.

For disposal, there are several possibilities:

- A) The municipality has established collection systems, where electronic waste can be disposed of at least free of charge to the user.
- B) When buying a new product, the retailer will take back the old product at least free of charge.
- C) The manufacture will take back the old appliance for disposal at least free of charge to the user.
- D) As old products contain valuable resources, they can be sold to scrap metal dealers.

Wild disposal of waste in forests and landscapes endangers your health when hazardous substances leak into the ground-water and find their way into the food chain.

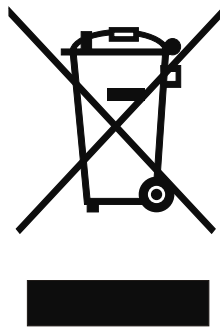

CAUTION:

- This appliance is not intended for use by persons (including children) with reduced physical, sensory or mental capabilities, or lack of experience and knowledge, unless they have been given supervision or instruction concerning use of the appliance by a person responsible for their safety.
- Children should be supervised to ensure that they do not play with the appliance.

SAFETY PRECAUTIONS

Safety rules

To prevent injury to the user or other people and property damage, the following instructions must be followed. Incorrect operation due to ignoring of instructions may cause harm or damage.

! Always do this

- Your air conditioner should be used in such a way that it is protected from moisture. e.g. condensation, splashed water, etc. Do not place or store your air conditioner where it can fall or be pulled into water or any other liquid. Unplug immediately.
- Always transport your air conditioner in a vertical position and stand on a stable, level surface during use.
- Turn off the product when not in use.
- Always contact a qualified person to carry out repairs. If the supply cord is damaged it must be repaired by a qualified repairer.
- Keep an air path of at least 30cm all around the unit from walls, furniture and curtains.
- If the air conditioner is knocked over during use, turn off the unit and unplug from the mains supply immediately.

⊘ Never do this

- Do not operate your air conditioner in a wet room such as a bathroom or laundry room.
- Do not touch the unit with wet or damp hands or when barefoot.
- Do not press the buttons on the control panel with anything other than your fingers.
- Do not remove any fixed covers. Never use this appliance if it is not working properly, or if it has been dropped or damaged.
- Never use the plug to start and stop the unit.
- Always use the switch on the control panel.
- Do not cover or obstruct the inlet or outlet grilles.
- Do not use hazardous chemicals to clean or come into contact with the unit. Do not use the unit in the presence of inflammable substances or vapour such as alcohol, insecticides, petrol, etc.
- Do not allow children to operate the unit unsupervised.
- Do not use this product for functions other than those described in this instruction manual.

Energy Save

- Use the unit in the recommended room size.
- Locate the unit where furniture cannot obstruct the air flow.
- Keep blinds/curtains closed during the sunniest part of the day.
- Keep the filters clean.
- Keep doors and windows closed to keep cool air in and warm air out.

Operating condition

- The air conditioner must be operated within the temperature range indicated below:

MODE	ROOM TEMPERATURE
COOL	17°C(62°F)~35°C(95°F)
DRY	13°C(55°F)~35°C(95°F)
HEAT(heat pump type)	5°C(41°F)~30°C(88°F)
HEAT(electrical heat type)	≤30°C/88°F

Suggested tools for window kit installation

1. Screwdriver(medium size Phillips)
2. Tape measure or ruler
3. Knife or scissors
4. Saw(In the event that the window kit needs to be cut down in size because the window is too narrow for direct installation)

IDENTIFICATION OF PARTS





▲ WARNING For your safety

- Do not store or use gasoline or other flammable vapors and liquids in the vicinity of this or any other appliance.
- Avoid fire hazard or electric shock. Do not use an extension cord or an adaptor plug. Do not remove any prong from the power cord.

▲ WARNING Electrical Information

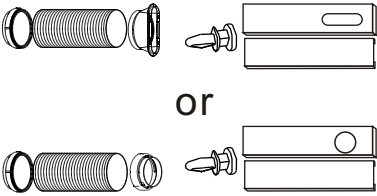
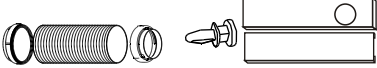
- Be sure the electrical service is adequate for the model you have chosen. This information can be found on the serial plate, which is located on the side of the cabinet and behind the grille.
- Be sure the air conditioner is properly grounded. To minimize shock and fire hazards, proper grounding is important. The power cord is equipped with a three-prong grounding plug for protection against shock hazards.
- Your air conditioner must be used in a properly grounded wall receptacle. If the wall receptacle you intend to use is not adequately grounded or protected by a time delay fuse or circuit breaker, have a qualified electrician install the proper receptacle.
- Ensure the receptacle is accessible after the unit installation.

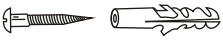
Accessories

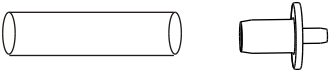
PARTS :	PARTS NAME :	QUANTITY :
 <p style="text-align: center;">or</p> 	Exhaust hose and Apaptorl and Adaptor B (flat mouth or round mouth :depending on models) Window Slider Kit and bolt	1 set
	Wall Exhaust Adaptor A(※)	1 pc
	Adaptor B(round mouth)(※)	1 pc
	Expansion Plug and wooden screw(※)	4/ pc
	Foam seal	3/pc
	Remote Controller and Battery (For remote control models only)	1pc
	Drain hose and drain hose adaptor(※)	1pc

NOTE: Optional parts(※), some models without.

- Check all the accessories are included in the package and please refer to the installation instructions for their usage.

NOTE: All the illustrations in this manual are for explanation purpose only. Your air conditioner may be slightly different. The actual shape shall prevail.

IDENTIFICATION OF PARTS

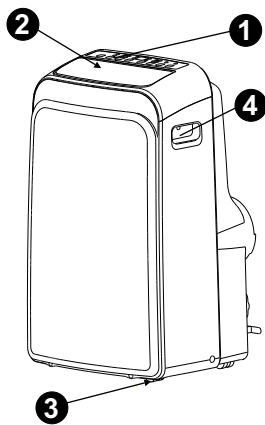

Fig.1

NAMES OF PARTS

Front

- ❶ Operation panel
- ❷ Horizontal louver blade (swing automatically)
- ❸ Caster
- ❹ Carrying handle (both sides)

Rear

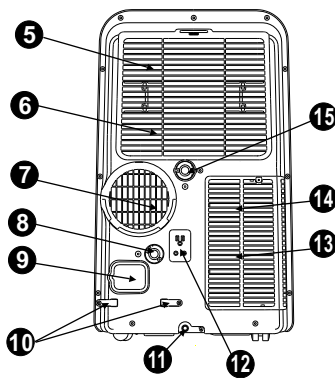

Fig.2

- ❺ Upper air filter (Behind the grille)
- ❻ Upper air intake
- ❼ Air outlet
- ❽ Drain outlet (only for Pump heating model)
- ❾ Power cord outlet
- ❿ Power cord buckle (Used only when storing the unit)
- ⓫ Bottom tray drain outlet
- ⓬ Power plug socket (Use only when storing the unit)
- ⓭ Lower air filter (Behind the grille)
- ⓮ Lower air intake
- ⓯ Drain outlet

AIR CONDITIONER FEATURES

ELECTRONIC CONTROL OPERATING INSTRUCTIONS

Before you begin, thoroughly familiarize yourself with the control panel and remote controller and all its functions, then follow the symbol for the functions you desire.

The unit can be controlled by the unit control panel alone or with the remote controller.

NOTE: This manual does not include Remote Controller Operations, see the <<Remote Controller Instruction>> packed with the unit for details.

OPERATION PANEL OF THE AIR CONDITIONER

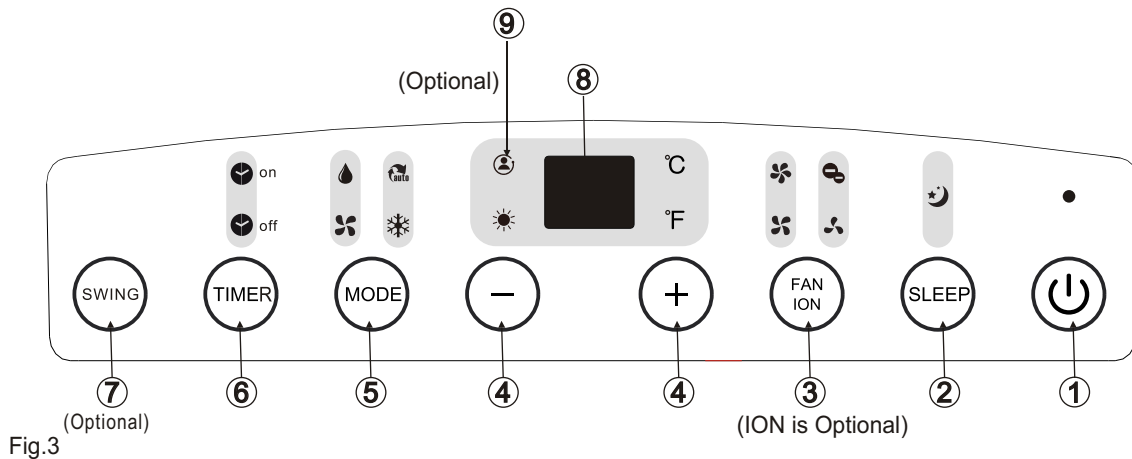

1 POWER button

Power switch on/off.

2 SLEEP button

Used to initiate the SLEEP operation.

3 FAN/ION button (ION is optional)

Control the fan speed. Press to select the fan speed in four steps-LOW, MED, HI and AUTO. The fan speed indicator light illuminates under different fan settings except AUTO speed. When select AUTO fan speed, all the fan indicator lights turn dark.

NOTE: Press this button for 3 seconds to initiate ION feature. The ion generator is energized and will help to remove pollen and impurities from the air, and trap them in the filter. Press it for 3 seconds again to stop the ION feature.

4 UP(+) and DOWN(-) button

Used to adjust (increasing/decreasing) temperature settings(1°C/2°F increments) in a range of 17°C(62°F) to 30°C(88°F) or the TIMER setting in a range of 0~24hrs..

NOTE: The control is capable of displaying temperature in degrees Fahrenheit or degrees Celsius. To convert from one to the other, press and hold the Up and Down buttons at the same time, for 3 seconds.

5 MODE select button

Selects the appropriate operating mode. Each time you press the button, a mode is selected in a sequence that goes from AUTO, COOL, DRY, FAN and HEAT(cooling only models without). The mode indicator light illuminates under the different mode settings.

6 TIMER button

Used to initiate the AUTO ON start time and AUTO OFF stop time program, in conjunction with the + & - buttons. The timer on/off indicator light illuminates under the timer on/off settings.

7 SWING button

(Applicable to the models with auto swing feature only)

Used to initiate the Autoswing feature. When the operation is ON, press the SWING button can stop the louver at the desired angle.

8 LED Display

Shows the set temperature in "°C" or "°F" and the Auto-timer settings.

While on DRY and FAN modes, it shows the room temperature.

OPERATING INSTRUCTIONS

Error codes and protection code:

- E1-** Room temperature sensor error-
Unplug the unit and plug it back in.
If error repeats, call for service.
- E2-** Evaporator temperature sensor error-
Unplug the unit and plug it back in.
If error repeats, call for service.
- E3-** Conenser temperature sensor error-
Unplug the unit and plug it back in. If error repeats, call for service.
- E4-** *Display panel communication error-*
Unplug the unit and plug it back in.
If error repeats, call for service.
- P1-** Bottom tray is full - Connect the drain hose and drain the collected water away. If protection repeats, call for service.

9 FOLLOW ME/TEMP SENSING feature(optional)

NOTE: *This feature can be activated from the remote control ONLY. The remote control serves as a remote thermostat allowing for the precise temperature control at its location.*

To activate the Follow Me/Temp Sensing feature, point the remote control towards the unit and press the Follow Me/Temp Sensing button. The remote display is actual temperature at its location. The remote control will send this signal to the air conditioner every 3 minutes interval until press the Follow Me/Temp Sensing button again. If the unit does not receive the Follow Me/Temp Sensing signal during any 7 minutes interval, the unit will beep to indicate the Follow Me/Temp Sensing mode has ended.

Operating Instructions

COOL operation

- Press the "MODE" button until the "COOL" indicator light comes on.
- Press the ADJUST buttons "+" or "-" to select your desired room temperature. The temperature can be set within a range of 17°C-30°C/62°F-88°F.
- Press the "FAN SPEED" button to choose the fan speed.

HEAT operation(cooling only models without)

- Press the "MODE" button until the "HEAT" indicator light comes on.
- Press the ADJUST buttons "+" or "-" to select your desired room temperature. The temperature can be set within a range of 17°C-30°C/62°F-88°F.
- Press the "FAN SPEED" button to choose the fan speed. For some models, the fan speed can not be adjusted under HEAT mode.

- Press the "MODE" button until the "DRY" indicator light comes on.
- Under this mode, you cannot select a fan speed or adjust the temperature. The fan motor operates at LOW speed.
- Keep windows and doors closed for the best dehumidifying effect.
- Do not put the duct to window.

AUTO operation

- When you set the air conditioner in AUTO mode, it will automatically select cooling, heating(cooling only models without), or fan only operation depending on what temperature you have selected and the room temperature.
- The air conditioner will control room temperature automatically round the temperature point set by you.
- Under AUTO mode, you can not select the fan speed.

FAN operation

- Press the "MODE" button until the "FAN " indicator light comes on.
- Press the "FAN SPEED" button to choose the fan speed. The temperature cannot be adjusted.
- Do not put the duct to window.

TIMER operation

- When the unit is on, press the Timer button will initiate the Auto-off stop program, the TIMER OFF indicator light illuminates. Press the UP or down button to select the desired time. Press the TIMER button again within 5 seconds, the Auto-on start program is initiated. And the TIMER ON indicator light illuminates. Press the up or down button to select the desired Auto-on start time.
- When the unit is off, press the Timer button to initiate the Auto-on start program, press it again within five seconds will initiate the Auto-off stop program.
- Press or hold the UP or DOWN button to change the Auto time by 0.5 hour increments, up to 10 hours, then at 1 hour increments up to 24 hours. The control will count down the time remaining until start.
- The system will automatically revert back to display the previous temperature setting if there is no operation in a five seconds period.

OPERATING INSTRUCTIONS

- Turning the unit ON or OFF at any time or adjusting the timer setting to 0.0 will cancel the Auto Start/ Stop timer program.
- When the malfunction (E1, E2, E3 or E4) occurs, the Auto Start/Stop timed program will also be cancelled.

SLEEP operation

Press this button, the selected temperature will increase (cooling) or decrease (heating) by 1°C/2°F 30 minutes. The temperature will then increase (cooling) or decrease (heating) by another 1°C/2°F after an additional 30 minutes. This new temperature will be maintained for 7 hours before it returns to the originally selected temperature. This ends the Sleep mode and the unit will continue to operate as originally programmed.

NOTE: This feature is unavailable under FAN or DRY mode.

Other features

Auto-Restart (on some models)

If the unit breaks off unexpectedly due to the power cut, it will restart with the previous function setting automatically when the power resumes.

Wait 3 minutes before resuming operation

After the unit has stopped, it can not be restarted operation in the first 3 minutes. This is to protect the unit. Operation will automatically start after 3 minutes.

Air flow direction adjustment

The louver can be adjusted automatically.

- **Adjust the air flow direction automatically (Fig.4):**
 - When the Power is ON, the louver opens fully. Press the SWING button on the panel or remote controller to initiate the Auto swing feature.
 - The louver will swing up and down automatically.
 - Please do not adjust the louver manually.



Fig.4

INSTALLATION INSTRUCTIONS(optional)

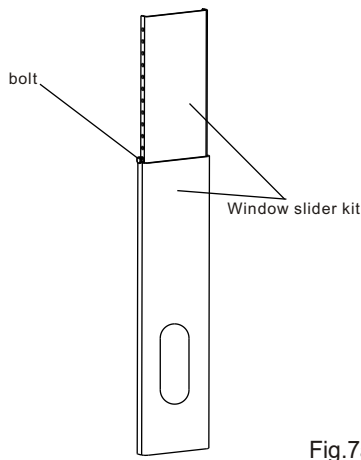
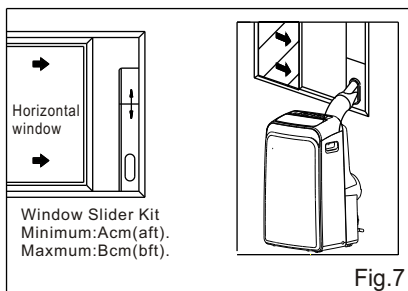
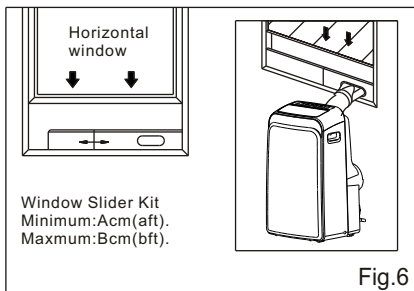
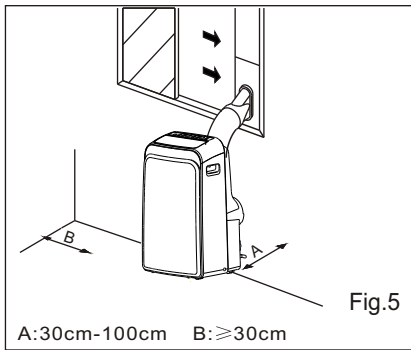

INSTALLATION INSTRUCTIONS

Location

- The air conditioner should be placed on a firm foundation to minimize noise and vibration. For safe and secure positioning, place the unit on a smooth, level floor strong enough to support the unit.
- The unit has casters to aid placement, but it should only be rolled on smooth, flat surfaces. Use caution when rolling on carpet surfaces. Do not attempt to roll the unit over objects.
- The unit must be placed within reach of a properly rated grounded socket.
- Never place any obstacles around the air inlet or outlet of the unit.
- Allow 30cm to 100cm of space from the wall with for efficient air-conditioning.

Window slider kit Installation

Your window slider kit has been designed to fit most standard "Vertical" and "horizontal" window applications, However, it may be necessary for you to improvise/modify some aspects of the installation procedures for certain types of window. Please refer to Fig. 6& Fig.7 for minimum and maximum window openings. Window slider kit can be fixed with a bolt (see Fig.7a).

Note: If the window opening is less than the mentioned minimum length of the window slider kit, cut that one with a hole in it short to fit for the window opening. Do never cut out the hole in window slider kit.

	A	a	B	b
Type I	67.5	2.22	123	4.04
Type II	56.2	1.84	98.2	3.22

INSTALLATION INSTRUCTIONS(optional)

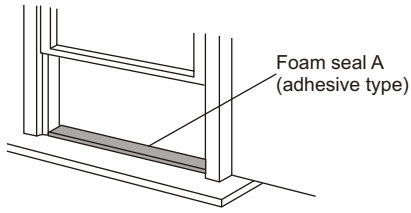

Fig.8

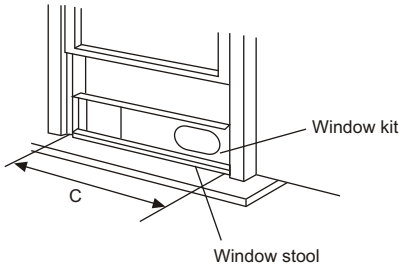

Fig.9

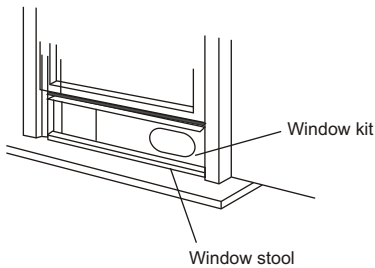

Fig.10

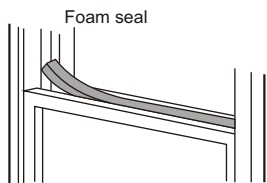

Fig.11

Installation in a double-hung sash window

1. Cut the foam seal(adhesive type) to the proper length and attach it to the window stool. Fig.8
2. Attach the window slider kit to the window stool. Adjust the length of the window slider kit according to the width of window, shorten the adjustable window kit if the width of window is less than 26.5 (Type I) or 22.1 (Type II) inches Open the window sash and place the window slider kit on the window stool. Fig.9
3. Cut the foam seal(adhesive type) to the proper length and attach it on the top of the window. Shown as in Fig.10
4. Close the window sash securely against the window.
5. Cut the foam seal to an appropriate length and seal the open gap between the top window sash and outer window sash. Shown as in Fig.11.

	C
Type I	26.5"~ 48.0"
Type II	22.1"~ 38.6"

INSTALLATION INSTRUCTIONS(optional)

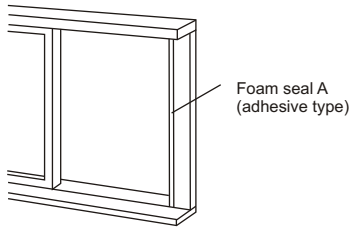

Fig.12

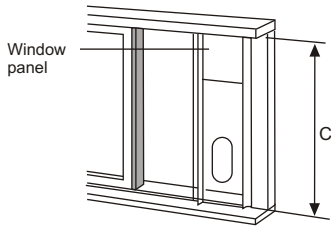

Fig.13

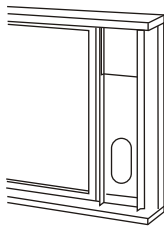

Fig.14

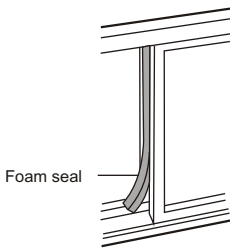

Fig.15

Installation in a sliding sash window

1. Cut the foam seal(adhesive type) to the proper length and attach it to the window frame. See Fig.12.
2. Attach the window slider kit to the window stool. Adjust the length of the window slider kit according to the width of window, shorten the adjustable window kit if the width of window is less than 26.5 (Type I) or 22.1 (Type II) inches. Open the window sash and place the window slider kit on the window stool. See Fig.13.
3. Cut the foam seal(adhesive type) to the proper length and attach it on the top of the window. Shown as in Fig.14.
4. Close the sliding sash securely against the window.
5. Cut the foam seal to an appropriate length and sea the open gap between the top window sash and outer window sash. Shown as in Fig.15.

NOTE:All the illustrations in this manual are for explanation purpose only. Your unit may be slightly different. The actual shape shall prevail.

	C
Type I	26.5"~ 48.0"
Type II	22.1"~ 38.6"

INSTALLATION INSTRUCTIONS

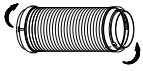

Fig. 16a

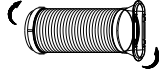

Fig. 16b

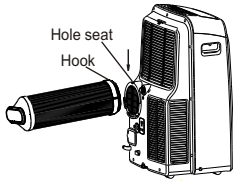

Fig. 17

Exhaust hose installation:

The exhaust hose and adaptor must be installed or removed in accordance with the usage mode.

COOL,HEAT(heat pump type) or AUTO mode	Install
FAN,DEHUMIDIIFY or HEAT(electrical heat type) mode	Remove

1. Install the adaptor B and adaptor I onto the exhaust hose as shown in Fig.16a or Fig.16b. Refer to the previous pages for window kit installation.
2. Resert the hook of the Exhaust hose into the hole seat of the air outlet and slide down the Exhaust hose along the arrow direction (See Fig.17) for installation.

The exhaust hose can be installed into the wall

(Not applicable to the units without adaptor A, expansion plugs and wooden screws of Accessories).

1. Prepare a hole in the wall. Install the wall Exhaust adaptor A onto the wall(outside) by using 4 expansion plugs and wooden screws, be sure to fix thoroughly. (See Fig.18)
2. Attach the Exhaust hose to wall Exhaust adaptor A.

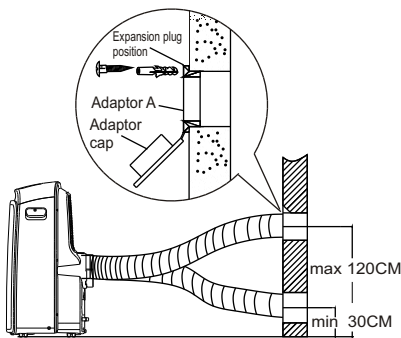

Fig. 18

Note:

Cover the hole using the adaptor cap when not in use.

- The exhaust hose can be compressed or extended moderately according to the installation requirement, but it is desirable to keep the hose length to a minimum.

IMPORTANT:

DO NOT OVER BEND THE EXHAUST HOSE (SEE Fig.19)

⚠ CAUTION:

Make sure that there is no obstacle around the air outlet of the exhaust hose (in the range of 500mm) in order to the exhaust system works properly.

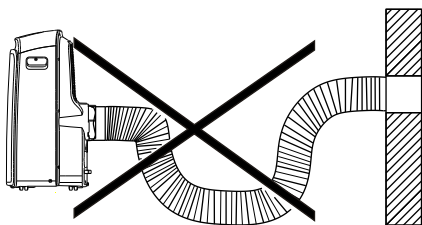

Fig. 19

INSTALLATION INSTRUCTIONS

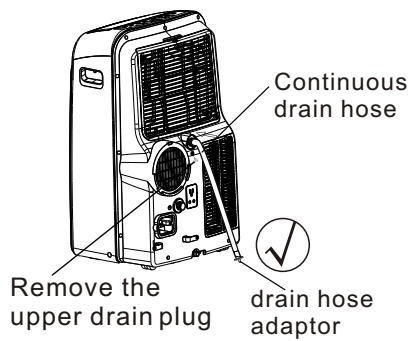

Fig.20a

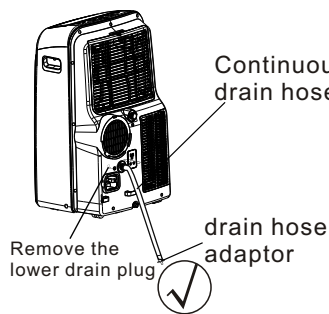

Fig.20b

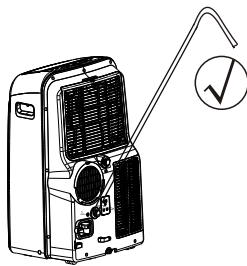

Fig.21a

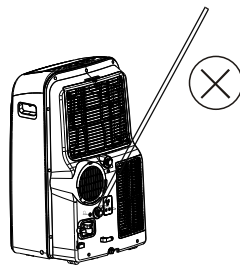

Fig.21b

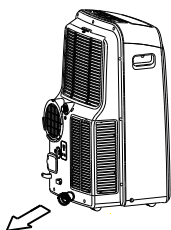

Fig.22

Water drainage:

- During dehumidifying modes, remove the upper drain plug from the back of the unit, install the drain connector(5/8" universal female mender) with 3/4" hose(locally purchased). For the models without drain connector, just attach the drain hose to the hole. Place the open end of the hose adaptor directly over the drain area in your basement floor. Please refer to Fig.20a.

- During heating pump mode, remove the lower drain plug from the back of the unit, install the drain connector(5/8" universal female mender) with 3/4" hose(locally purchased). For the models without drain connector, just attach the drain hose to the hole. Place the open end of the hose adaptor directly over the drain area in your basement floor. Please refer to Fig.20b.

NOTE: Make sure the hose is secure so there are no leaks. Direct the hose toward the drain, making sure that there are no kinks that will stop the water flowing. Place the end of the hose into the drain and make sure the end of the hose is down to let the water flow smoothly.(See Fig.20a,20b,21a). Do never let it up.(See Fig.21b).

- When the water level of the bottom tray reaches a predetermined level, the unit beeps 8 times, the digital display area shows "P1" . At this time the air conditioning/dehumidification process will immediately stop. However, the fan motor will continue to operate(this is normal).

Carefully move the unit to a drain location, remove the bottom drain plug and let the water drain away(Fig.22). Reinstall the bottom drain plug and restart the machine until the "P1" symbol disappears. If the error repeats, call for service.

NOTE: Be sure to reinstall the bottom drain plug before using the unit.

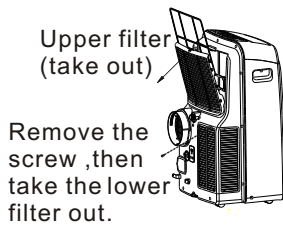

Fig.23

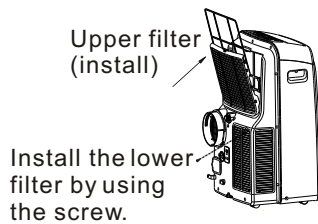

Fig.24

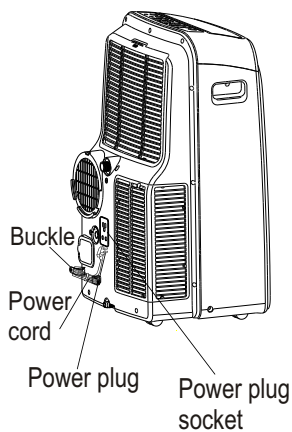

Fig.25

CARE AND MAINTENANCE

IMPORTANT:

- 1) Be sure to unplug the unit before cleaning or servicing.
- 2) Do not use gasoline, thinner or other chemicals to clean the unit.
- 3) Do not wash the unit directly under a tap or using a hose. It may cause electrical danger.
- 4) If the power cord is damaged, it should be repaired by manufacture or its agency.

1. Air filter

- Clean the air filter at least once every two weeks to prevent inferior fan operation because of dust.
- Removal
This unit has two filters. Take the upper filter out along the the arrow direction (Fig.23), then take the filter down. Remove the lower filter by loosening the screw, taking out the filter as shown in Fig.23.
- Cleaning
Wash the air filter by immersing it gently in warm water (about 40°C/104°F) with a neutral detergent. Rinse the filter and dry it in a shady place.
- Mounting
Install the upper air filter after cleaning, and install the lower filter by using the screw (see Fig.24).

2. Unit enclosure

- Use a lint-free cloth soaked with neutral detergent to clean the unit enclosure. Finished by a dry clean cloth.

3. Unit idle for a long time

- Remove the rubber plug at the back of the unit and attach a hose to drain outlet. Place the open end of the hose directly over the drain area in your basement floor (See Fig.20 & 21).
- Remove the plug from the bottom drain outlet, all the water in the bottom tray would drain out (See Fig.22).
- Keep the appliance running on FAN mode for half a day in a warm room to dry the appliance inside and prevent mold forming.
- Stop the appliance and unplug it, wrapped the cord and bundle it with the tape (Fig.25). Remove the batteries from the remote controller.
- Clean the air filter and reinstall it.

TROUBLESHOOTING TIPS

TROUBLE SHOOTING

TROUBLES	POSSIBLE CAUSES	SUGGEST REMEDIES
1. Unit does not Start when Pressing on/off Button	- P1 appears in the display window	Drain the water in the bottom tray.
	- Room temperature is lower than the set temperature.(Cooling mode)	Reset the temperature.
2. Not cool enough	- The windows or doors in the room are not closed.	Make sure all the windows and doors are closed.
	- There are heat sources inside the room.	Remove the heat sources if possible.
	- Exhaust air duct is not connected or blocked.	Connect the duct and make sure it can function properly.
	- Temperature setting is too high.	Decrease the set temperature.
	- Air filter is blocked by dust.	Clean the air filter.
4. Noisy or vibration	- The ground is not level or not flat enough.	Place the unit on a flat, level ground if possible.
5. Gurgling sound	- The sound comes from the flowing of the refrigerant inside the air-conditioner.	It is normal.
6. Power shut off at Heating mode	- The automatic over heat protection function. When the temperature at the air outlet exceed 70°C/158°F, the device will stop.	Switch on again after the unit has cool down.

The design and specifications are subject to change without prior notice for product improvement. Consult with the sales agency or manufacturer for details.

CP012IU-PD
202000192559
20121106