

# Rubbermaid®

## 7' x 7' STORAGE BUILDING Assembly Instructions

COBERTIZO DE ALMACENAMIENTO DE 7' x 7'  
Instrucciones de armado

ABRI DE RANGEMENT 7 PI x 7 PI  
Instructions d'assemblage

1V30

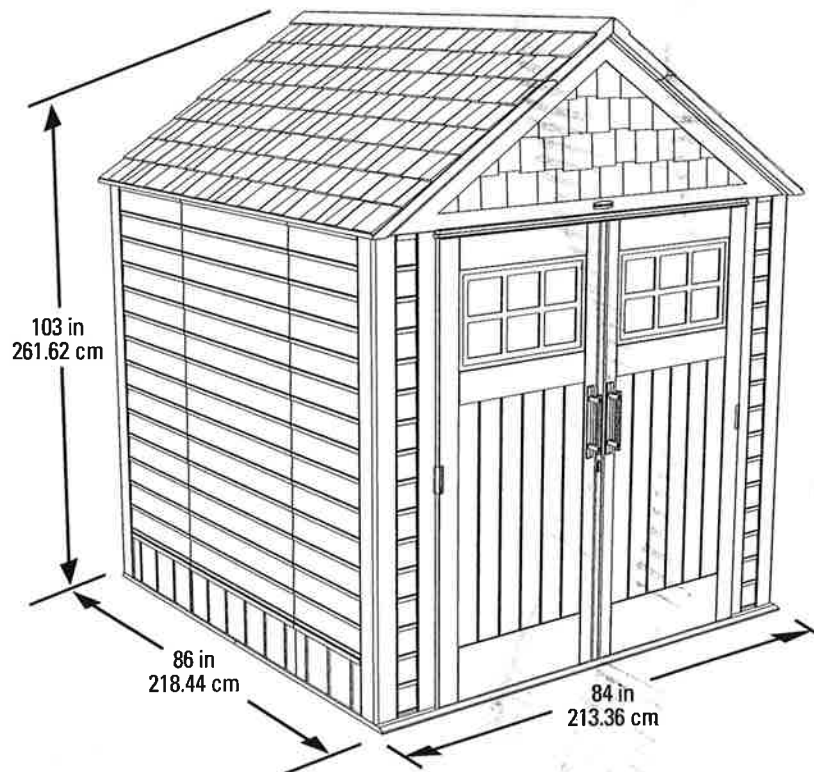

Thank you for purchasing this Rubbermaid® storage building. This dependable product was designed to look great outdoors and keep your yard organized. We want your experience to be a good one. Please read these instructions thoroughly before assembling the storage building.

Gracias por adquirir este cobertizo de almacenamiento Rubbermaid®. Este producto confiable ha sido diseñado para verse bien al aire libre y mantener su patio organizado. Queremos que tenga una buena experiencia. Por favor lea atentamente esta instrucciones antes de ensamblar el cobertizo de almacenamiento.

Merci d'avoir acheté cet abri de rangement Rubbermaid<sup>MD</sup>. Ce produit fiable a été conçu pour avoir une belle apparence à l'extérieur et vous aider à garder votre cour en ordre. Nous souhaitons que votre expérience soit agréable. Veuillez lire attentivement ces instructions avant de construire l'abri.

## Before you begin

1. Building Codes – Check your local building codes, ordinances and restrictions and applicable neighborhood governances.
2. Surface Preparation – To ensure proper assembly and performance, your storage building needs to be built on a solid, level surface. A concrete or patio surface or a treated-wood platform is recommended.
3. Location – When choosing a location in your yard, make sure you choose an area with easy access and one that provides proper drainage for water to run away from the storage building location.
4. Preassembly – Review ALL assembly steps before beginning construction. Follow all cautions and warnings carefully.
5. Preassembly – Review the parts list and make sure that no parts are missing.

## If you need help

If assistance is needed, do not contact or return to the store. Call our Consumer Service Department at 1-888-895-2110 (Mon.–Fri. 8:30 a.m. to 5:00 p.m. EST). Keep this instruction booklet and your original store receipt to ensure our Consumer Service Department can accurately and quickly assist you.

**Rubbermaid® Consumer Service Department**  
**1-888-895-2110**

**[www.Rubbermaid.com](http://www.Rubbermaid.com)**

## Warnings, Use & Care

- Always wear gloves when handling metal components.
- Always use eye protection/safety glasses during assembly.

 When installing screws, do not overtighten.

## Antes de comenzar

1. Códigos de construcción: revise las restricciones, las ordenanzas y los códigos de construcción locales así como también las disposiciones del vecindario correspondientes.
2. Preparación de la superficie – Para asegurar un ensamble adecuado y buenos resultados, su cobertizo debe ser instalado sobre una superficie sólida, nivelada. Una superficie de cemento o madera tratada.
3. Locación – Cuando elija la ubicación en su patio asegúrese de elegir un área con fácil acceso y que tenga buen drenaje de agua.
4. Prearmado: revise TODOS los pasos para el armado antes de comenzar. Siga atentamente todas las precauciones y las advertencias.
5. Prearmado: revise la lista de piezas y asegúrese de que no haya piezas faltantes.

## Si necesita ayuda

Si necesita asistencia, no llame a la tienda ni devuelva el producto. Llame a nuestro Departamento de Atención al Cliente al 1-888-895-2110 (de lunes a viernes, de 8:30 a.m. a 5:00 p.m. EST). Guarde este manual de instrucciones y la factura original de su tienda para garantizar que nuestro Departamento de Atención al Cliente pueda ayudarlo rápida y correctamente.

**Rubbermaid® Consumer Service Department**  
**1-888-895-2110**

**[www.Rubbermaid.com](http://www.Rubbermaid.com)**

## Advertencias, uso y mantenimiento

- Siempre use guantes al manipular los componentes metálicos.
- Siempre utilice protección para los ojos/gafas de seguridad durante el armado.

 No ajuste los tornillos en exceso.

## Avant de commencer

1. Codes du bâtiment – Vérifiez les codes du bâtiment locaux, les ordonnances et restrictions et les règlements de quartier applicables.
2. Préparation de la surface – Pour assurer un bon assemblage et une utilisation optimale votre abri de rangement doit être construit sur une surface solide et plane. Une dalle en béton, un patio ou une plate-forme en bois traité est recommandée.
3. Emplacement – Lorsque vous déterminez l'emplacement de l'abri dans votre jardin, assurez-vous de choisir une zone facile d'accès et avec une bonne évacuation de l'eau.
4. Préassemblage – Lisez attentivement TOUTES les étapes avant de commencer l'assemblage. Suivez attentivement toutes les précautions et mises en garde.
5. Préassemblage – Examinez la liste des pièces et assurez-vous qu'il n'en manque aucune.

## Si vous avez besoin d'aide

Si vous avez besoin d'aide, ne communiquez pas avec le magasin et ne retournez pas le produit. Appelez notre service aux consommateurs au 1-888-895-2110 (lun. au ven. de 8 h 30 à 17 h HNE). Veuillez garder le présent livret d'instructions et le reçu du magasin afin que notre service aux consommateurs puisse vous aider adéquatement.

**Rubbermaid® Consumer Service Department**  
**1-888-895-2110**

**www.Rubbermaid.com**

## Mises en garde, utilisation et entretien

- Toujours porter des gants lors de la manutention de composants en métal.
- Utilisez toujours une protection des yeux/lunettes de protection pendant l'assemblage.

 Ne serrez pas trop les boulons lorsque vous les installez.



Safety Glasses

Gafas de seguridad

Lunettes de sécurité



Gloves

Guantes

Gants



Phillips Screwdriver

Destornillador de cabeza Phillips

Tournevis Phillips

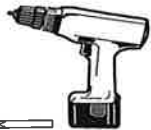

Drill

Taladro

Perceuse

Phillips Bit  
Broca Phillips | Pointe Philips

7/16" Bit  
Tubo de 7/16" | Embout 7/16 po



7/16" Combination Wrench

Llave combinada 7/16"

Clé mixte 7/16 po

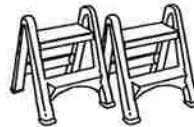

(2) Stepladders

(2) Escaleras de escalones

(2) Escabeaux



7/16" Ratchet Wrench

Llave de torque 7/16"

Clé à cliquet 7/16 po

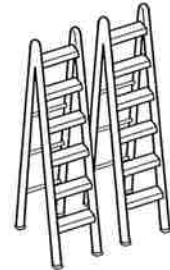

(2) 6 Foot Stepladders

(2) Escaleras de 6 escalones

(2) Escabeaux 6 pi





**A - 1**

Left Front Corner  
Esquina frontal izquierda  
Coin avant gauche



**B - 1**

Left Side  
Lado izquierdo  
Côté gauche



**C - 1**

Left Back Corner  
Esquina trasera izquierda  
Coin arrière gauche



**D - 1**

Left Back  
Dorso izquierdo  
Arrière gauche



**E - 1**

Right Front Corner  
Esquina frontal derecha  
Coin avant droit



**F - 1**

Right Side  
Lado derecho  
Côté droit



**G - 1**

Right Back Corner  
Esquina trasera derecha  
Coin arrière droit



**H - 1**

Right Back  
Dorso derecho  
Arrière droit



**J - 1**

Front Floor  
Piso frontal  
Plancher avant



**K - 1**

Back Floor  
Piso trasero  
Plancher arrière

---

**L - 1**

---



Rear Window Frame  
Marco de ventana trasera  
Encadrement de  
fenêtre arrière

---

**RWG - 1**

---



Rear Window Gasket  
Junta de ventana trasera  
Joint de fenêtre arrière

---

**RW - 1**

---

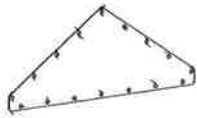

Rear Window  
Ventana trasera  
Fenêtre arrière

---

**M - 1**

---



Front Gable  
Techo frontal  
Pignon avant

---

**N - 1**

---



Left Door  
Puerta izquierda  
Porte gauche

---

**P - 1**

---



Right Door  
Puerta derecha  
Porte droite

---

**Q - 2**

---



Lower Roof  
Tejado inferior  
Toit inférieur

---

**R - 1**

---



Upper Roof  
Tejado superior  
Toit supérieur

---

**T - 2**

---



Door Handle  
Manija de la puerta  
Poignée

---

**X (M1-5F58) - 1**

---



Lock Hasp  
Aldaba de candado  
Morillon de serrure



**AA - 156**

#14 x .75 Screws  
#14 x .75 Tornillos  
#14 x .75 Vis



**AB (M25H88) - 12**

Accessory Bracket  
Ménsula accesoria  
Accessoire de fixation



**BB - 26**

#8 x .75 Flat Head Phillips  
Self Tapping Screws  
Tornillos autorroscantes Phillips  
de cabeza chata #8 x .75  
Vis autotaraudeuses  
Phillips à tête plate N°  
8 x 0,75



**CC - 42**

#8 x .75 Pan Head Phillips  
Self Tapping Screws  
Tornillos autorroscantes Phillips  
de cabeza redonda #8 x .75  
Vis autotaraudeuses  
Phillips à tête cylindrique  
N° 8 x 0,75



**CT - 1**

Collar Tie  
Abrazadera para tirante  
Entrait retroussé

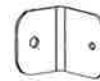

**CTB (1890913) - 4**

Collar Tie Bracket  
Ménsula de abrazadera  
para tirante  
Fixation pour entrait  
retroussé



**DD - 6**

1/4"-20 x 1.375 Hex Bolt  
Tornillo hexagonal de  
1/4"-20 x 1.375  
Boulon hexagonal  
1/4 po- 20 x 1,375



**DR - 2**

Door Reinforcement  
Refuerzo de puerta  
Renfort de porte



**DW - 2**

Door Window  
Puerta ventana  
Vitre de porte

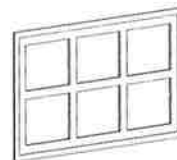

**DWF - 2**

Door Window Frame  
Marco para puerta ventana  
Encadrement de vitre  
de porte



**DWG** - 2

Door Window Gasket  
Junta para puerta ventana  
Joint de vitre de porte

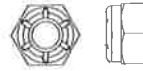

**EE** - 2

1/4"-20 Hex Nylon Lock Nut  
Contratuerca hexagonal  
de nylon de 1/4"-20  
Contre-écrou hexagonal  
à garniture de nylon  
1/4 po - 20



**FF** - 12

#8 x .75 Truss Washer  
Self Drilling Screws  
Arandela de celosía #8 x .75  
tornillos auto perforantes  
Vis cruciforme N° 8 x 0,75  
vis autoperceuses



**GG** - 4

1/4" SAE Flat Washer  
Arandela plana SAE 1/4"  
Rondelle plate SAE 1/4 po



**HB** - 2

Door Middle Hinge  
Bisagra de puerta central  
Charnière milieu de porte



**HD** - 2

Header  
Cabecera  
Linteau



**JJ** - 42

#8 Neoprene Washer  
Arandela de neopreno #8  
Rondelle en néoprène N° 8

**RPN (1890911)** - 8

Roof Pin  
Pasador para  
el techo  
Barrette de toit



**RPR** - 2

Roof Purlin  
Travesaño  
Panne de charpente

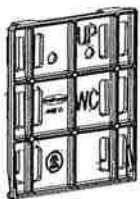

**WC** - 29

Wall Connector  
Conector de pared  
Connecteur mural

**TIP (optional):**

To simplify assembly and to ensure proper engagement of all wall panels, apply a mild detergent to the dovetails on the side of panels before snapping panels together.

**Consejo (opcional):**

Para simplificar el armado y asegurar la correcta unión de los paneles de las paredes, aplique un detergente suave a las colas de milano a los costados de los paneles antes de encajarlos.

**Conseil (facultatif) :**

Pour simplifier l'assemblage et pour assurer un bon emboîtement de tous les panneaux muraux, appliquez du détergent doux sur la queue d'aronde sur le côté des panneaux avant de les emboîter.

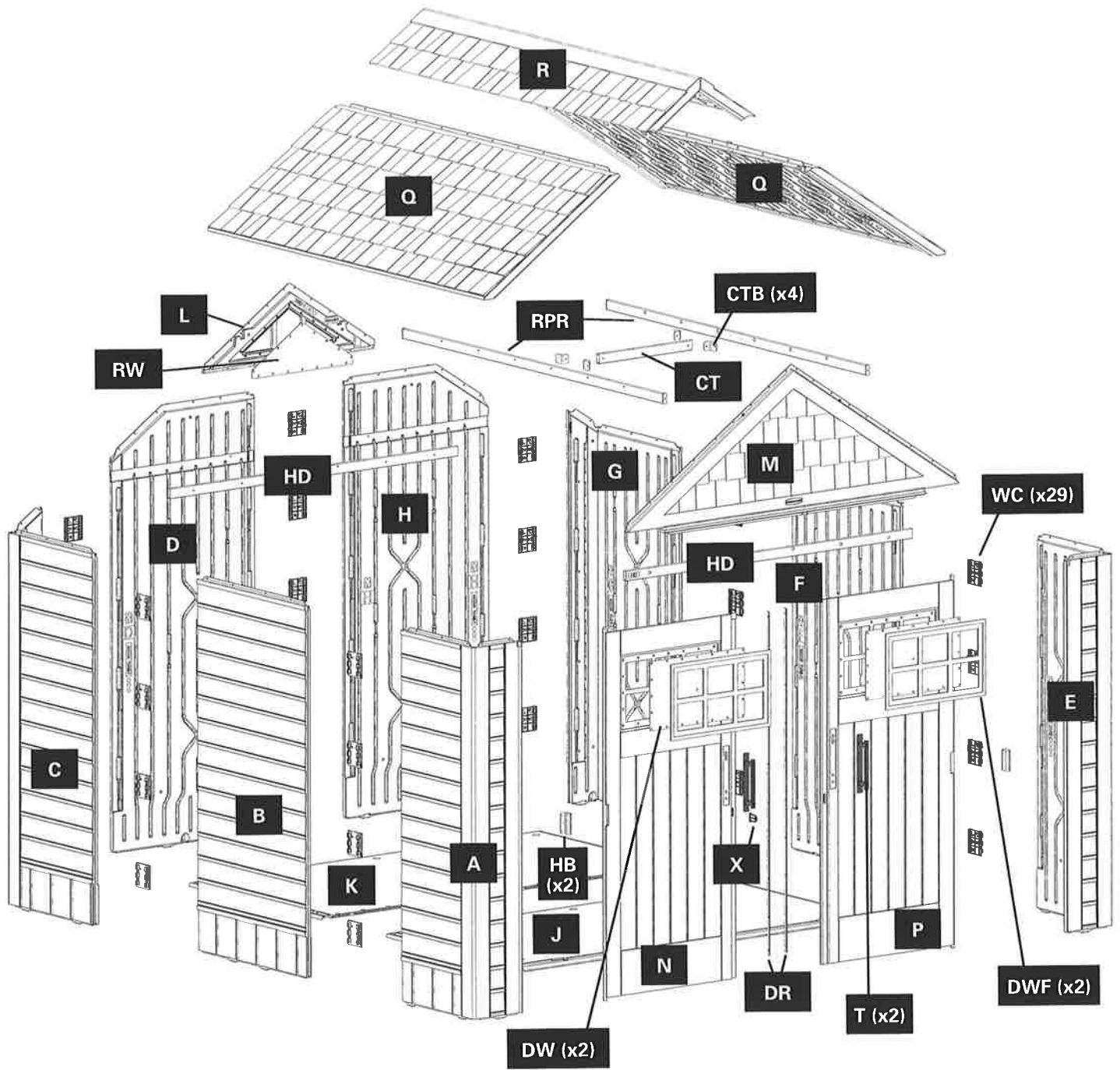



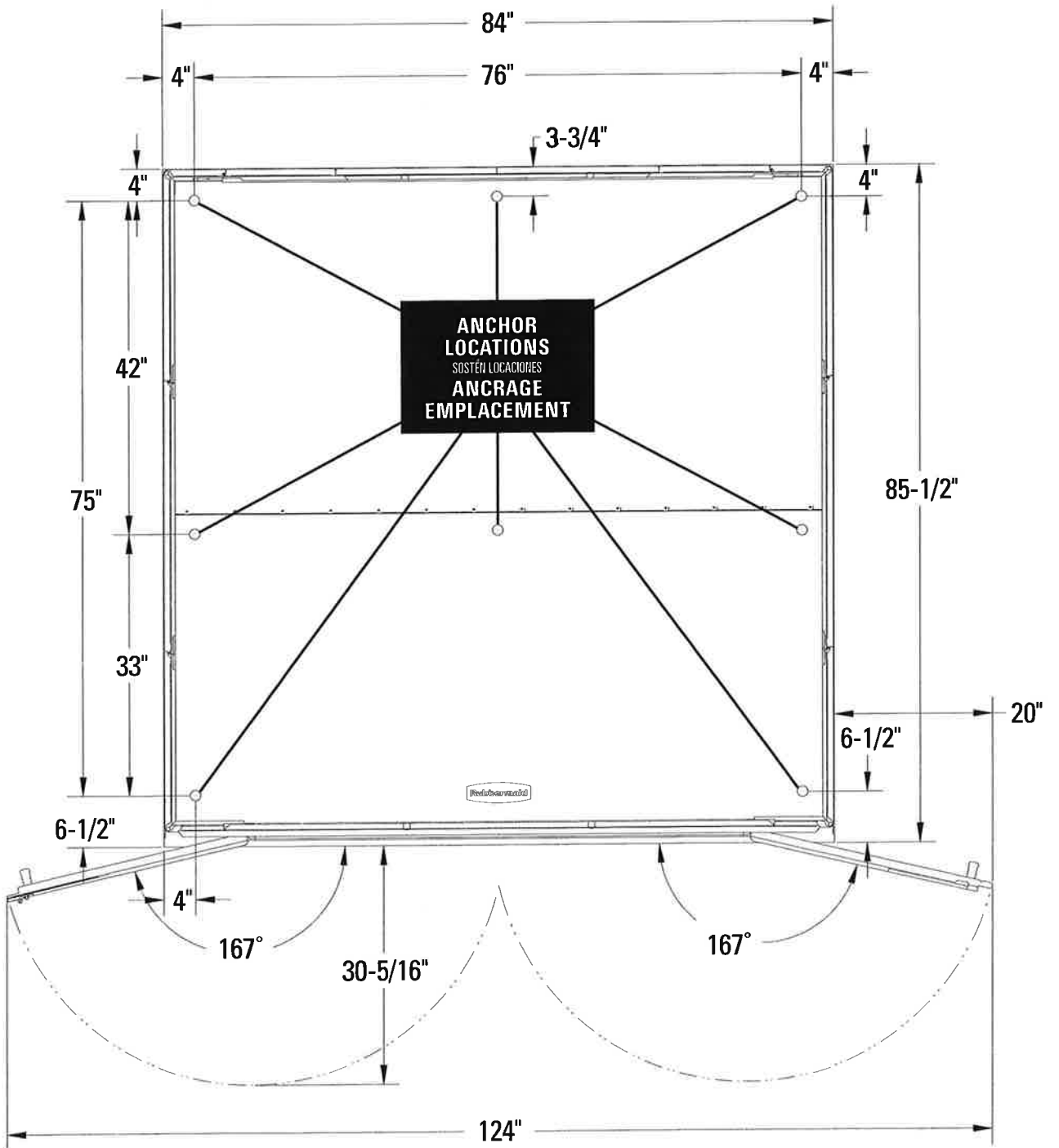
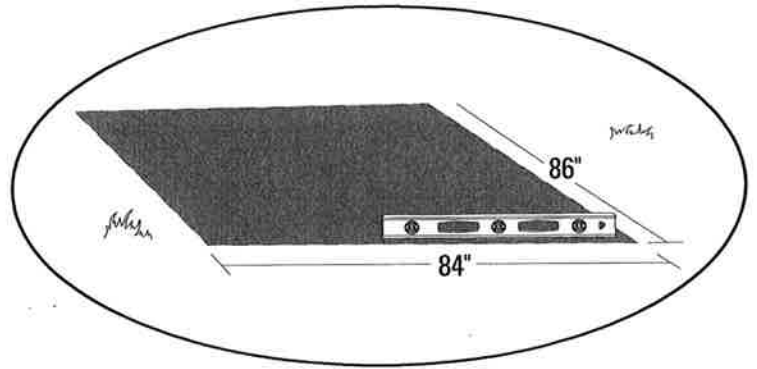

1



2

	AA	14
	J	1
	K	1



AA x 14

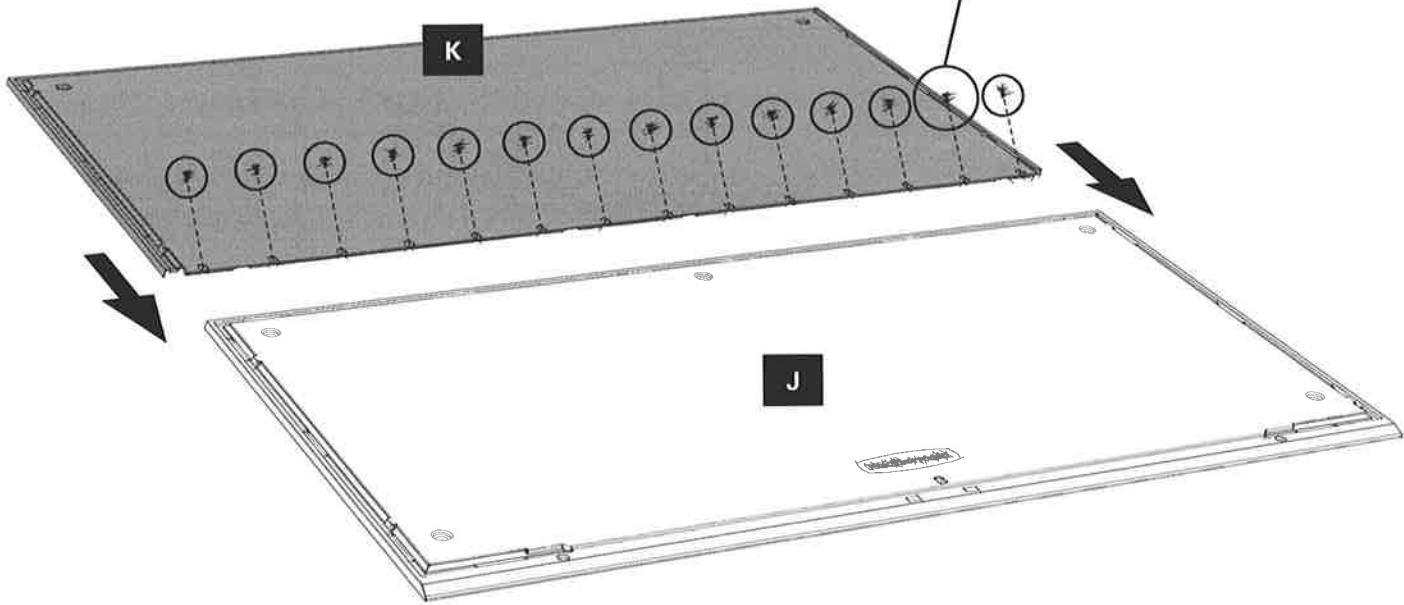

**DO NOT**  
overtighten screws!  
¡NO ajuste los tornillos en exceso!  
**ÉVITEZ**  
de trop serrer les boulons!



**3a**

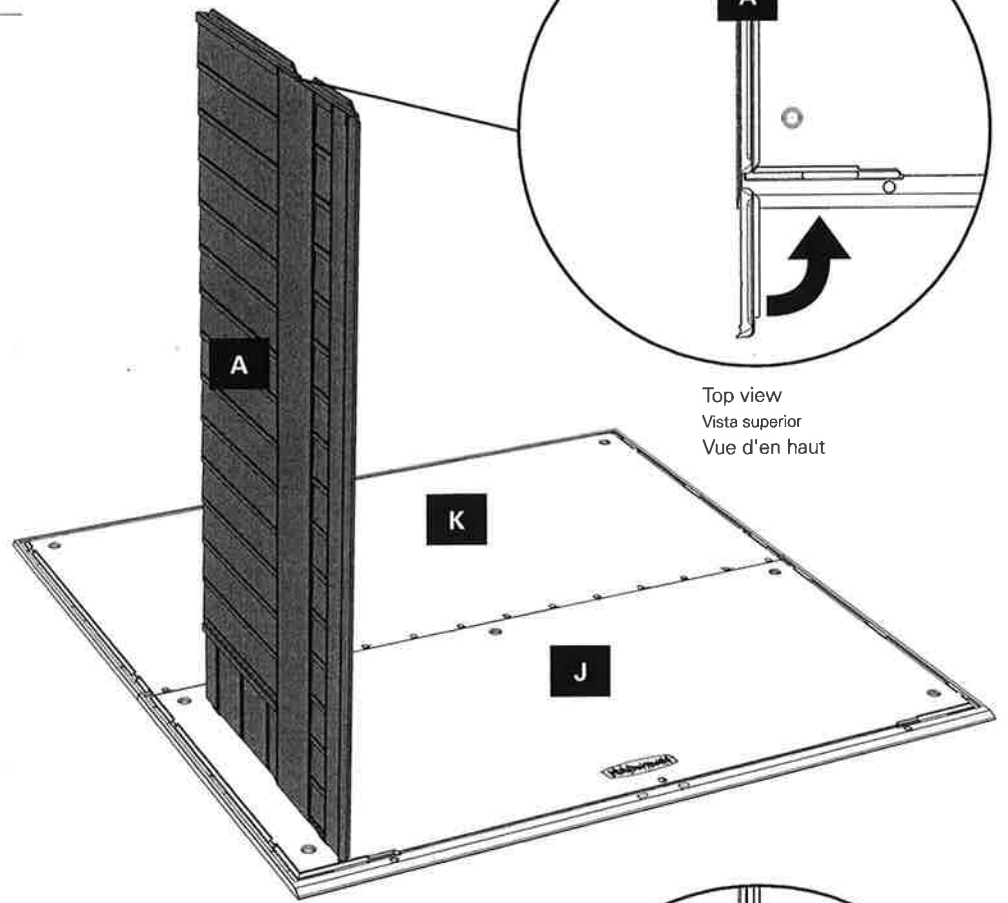
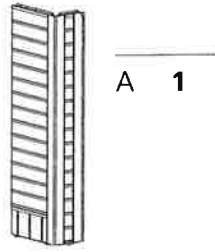

**3b**

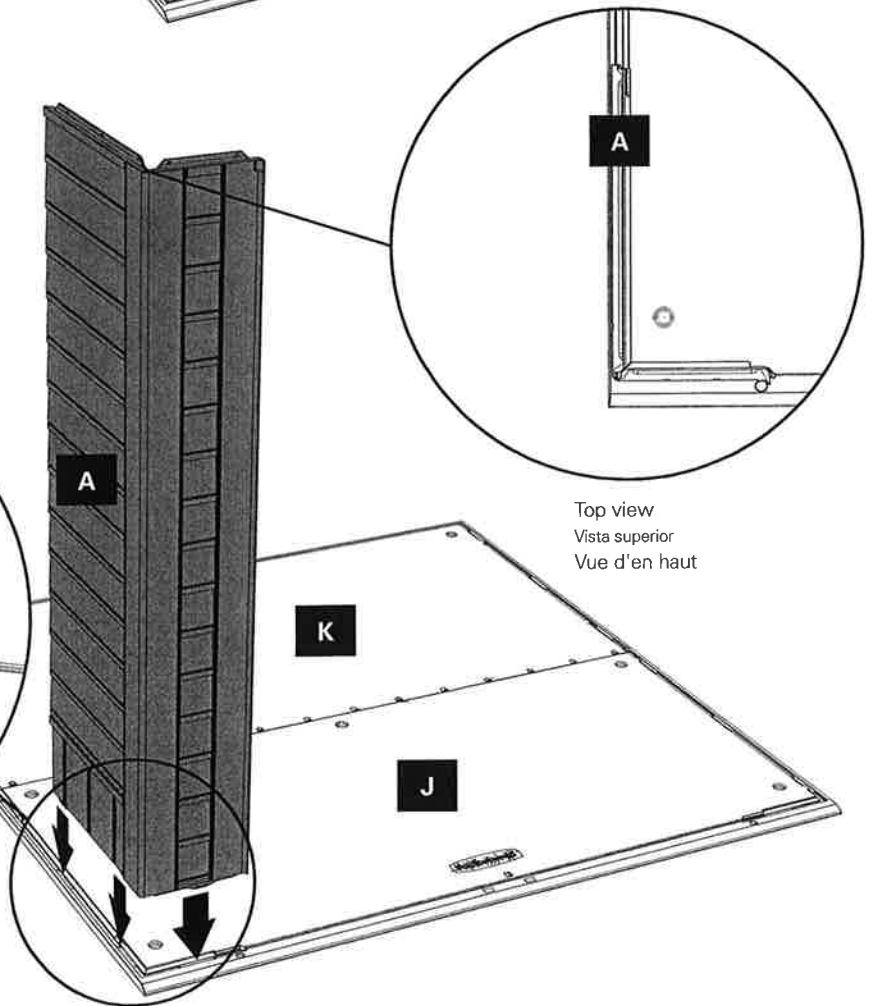
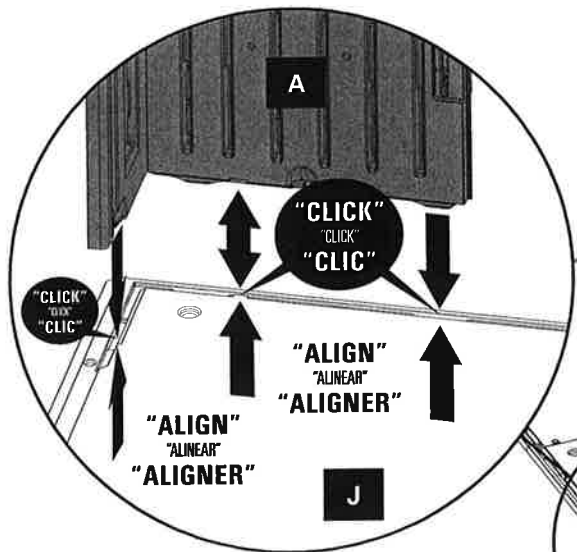

4a

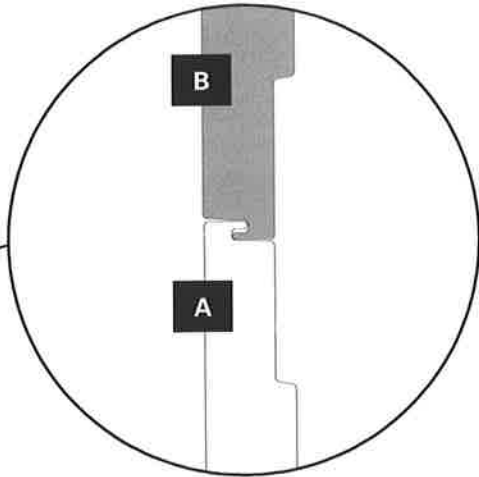
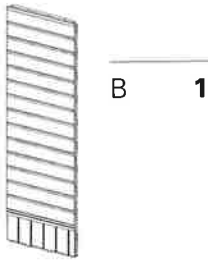

Overlap joint engagement  
Engranaje de junta superpuesta  
Emboîtement du joint à recouvrement

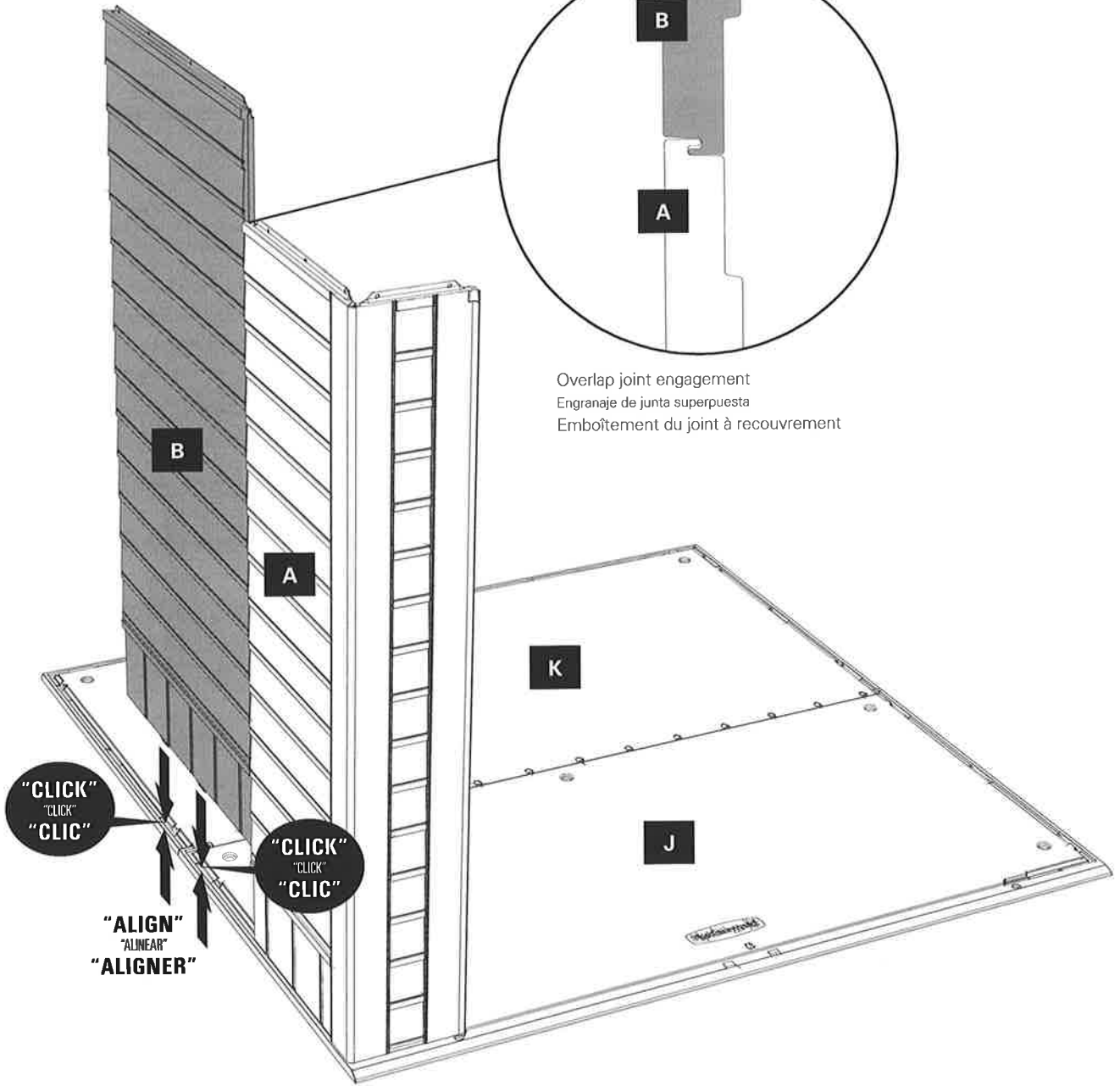

**4b**



WC 4

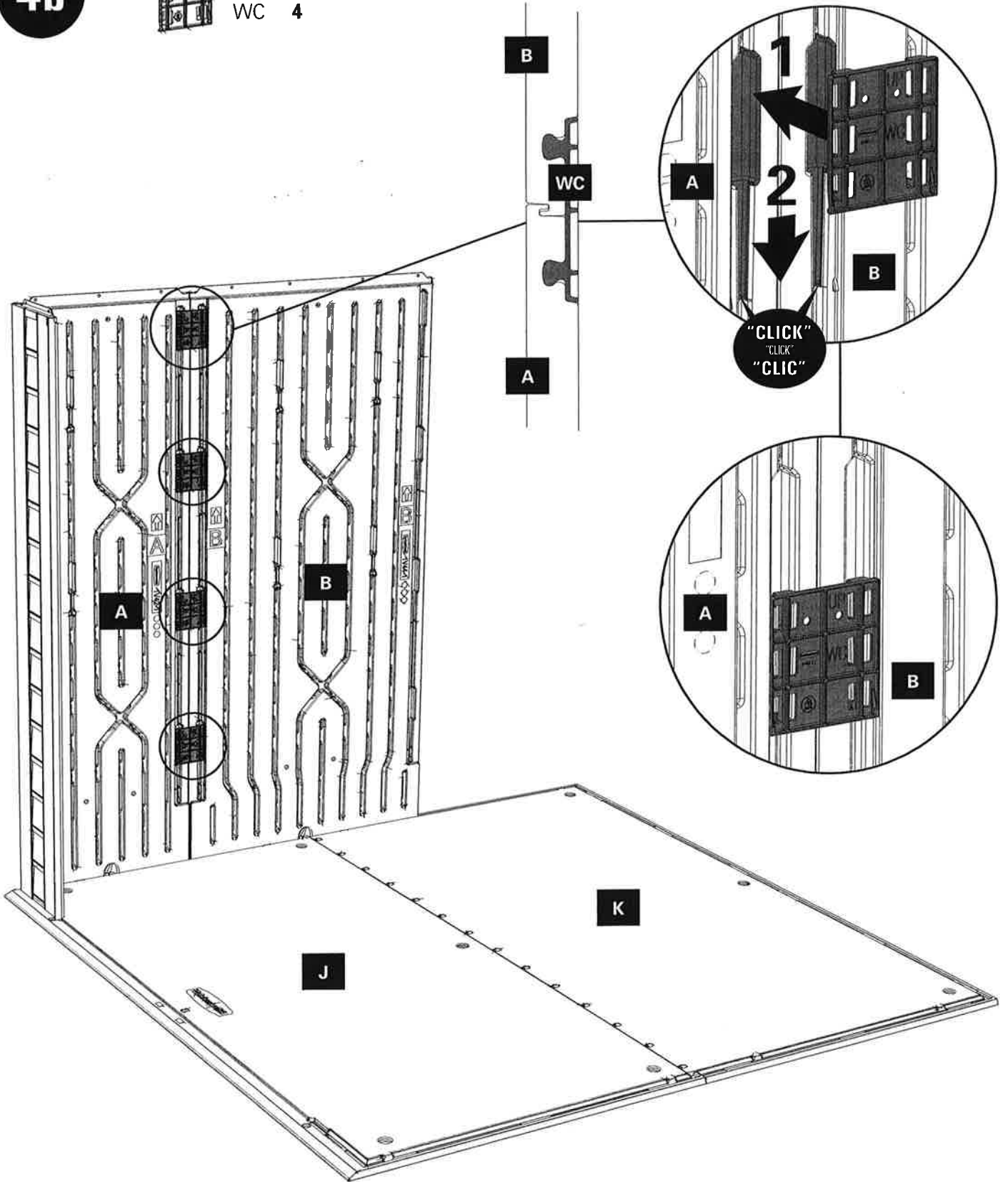

5a

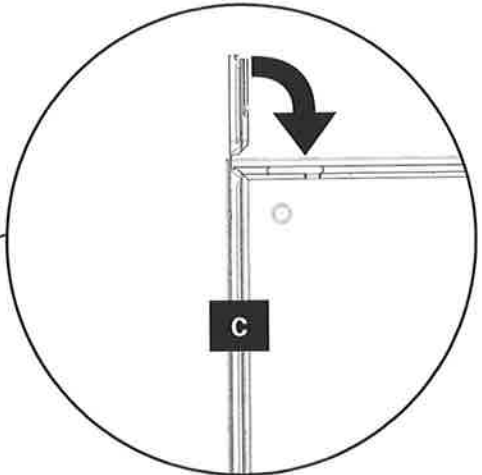
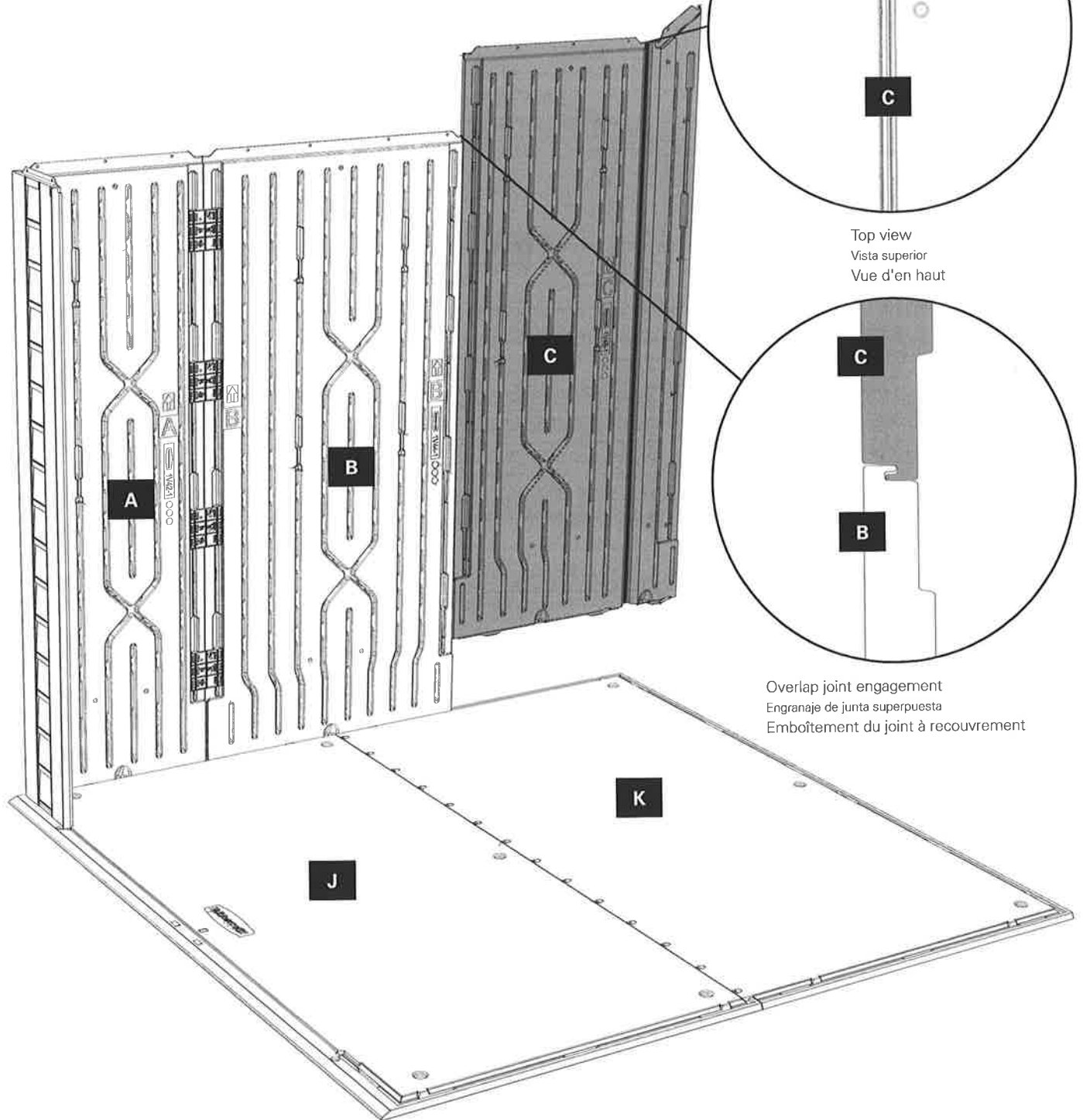
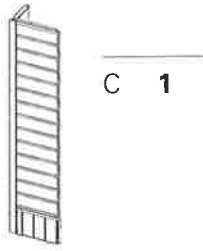

Top view  
Vista superior  
Vue d'en haut

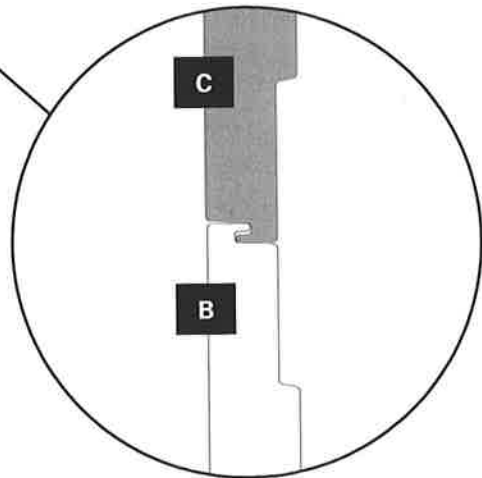

Overlap joint engagement  
Engranaje de junta superpuesta  
Emboîtement du joint à recouvrement

# 5a

Continued.

Continúa.

Suite.

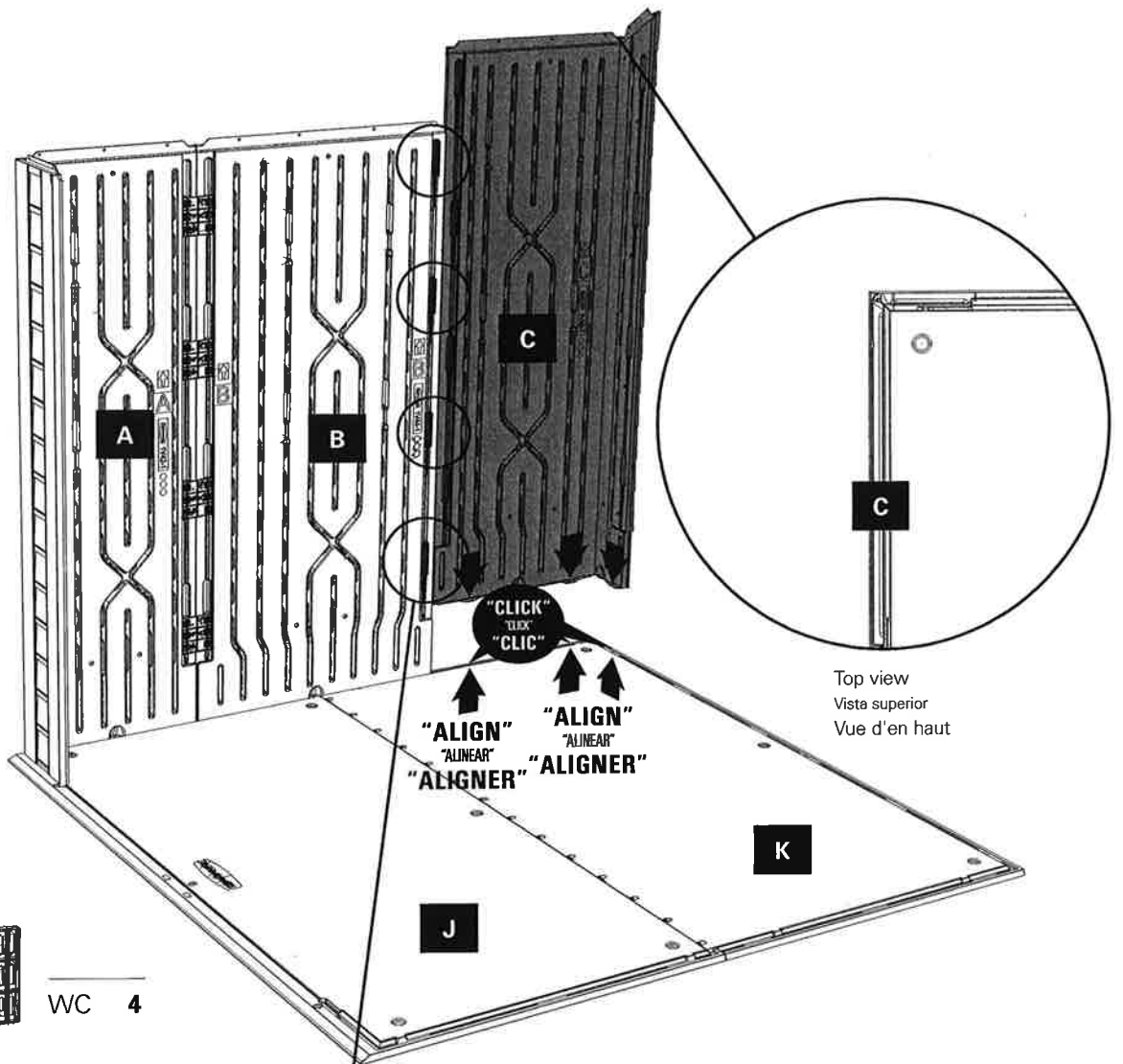

# 5b



WC 4

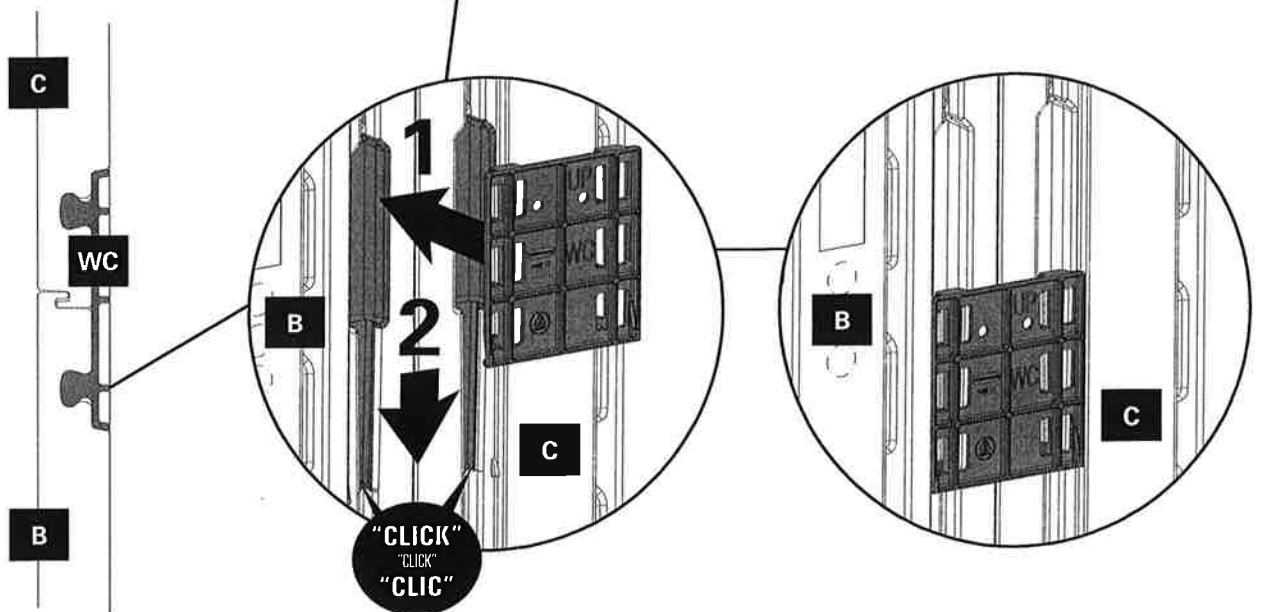

6a



D 1

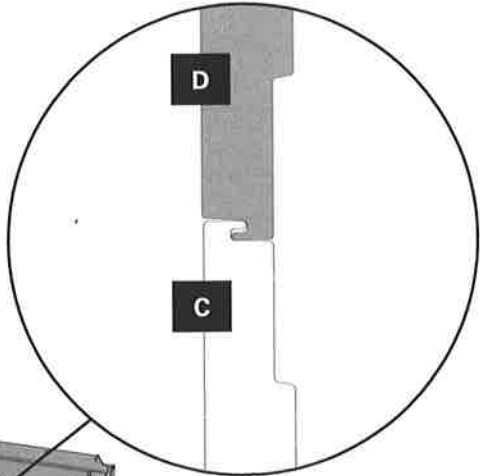

Overlap joint engagement  
Engranaje de junta superpuesta  
Emboîtement du joint à recouvrement

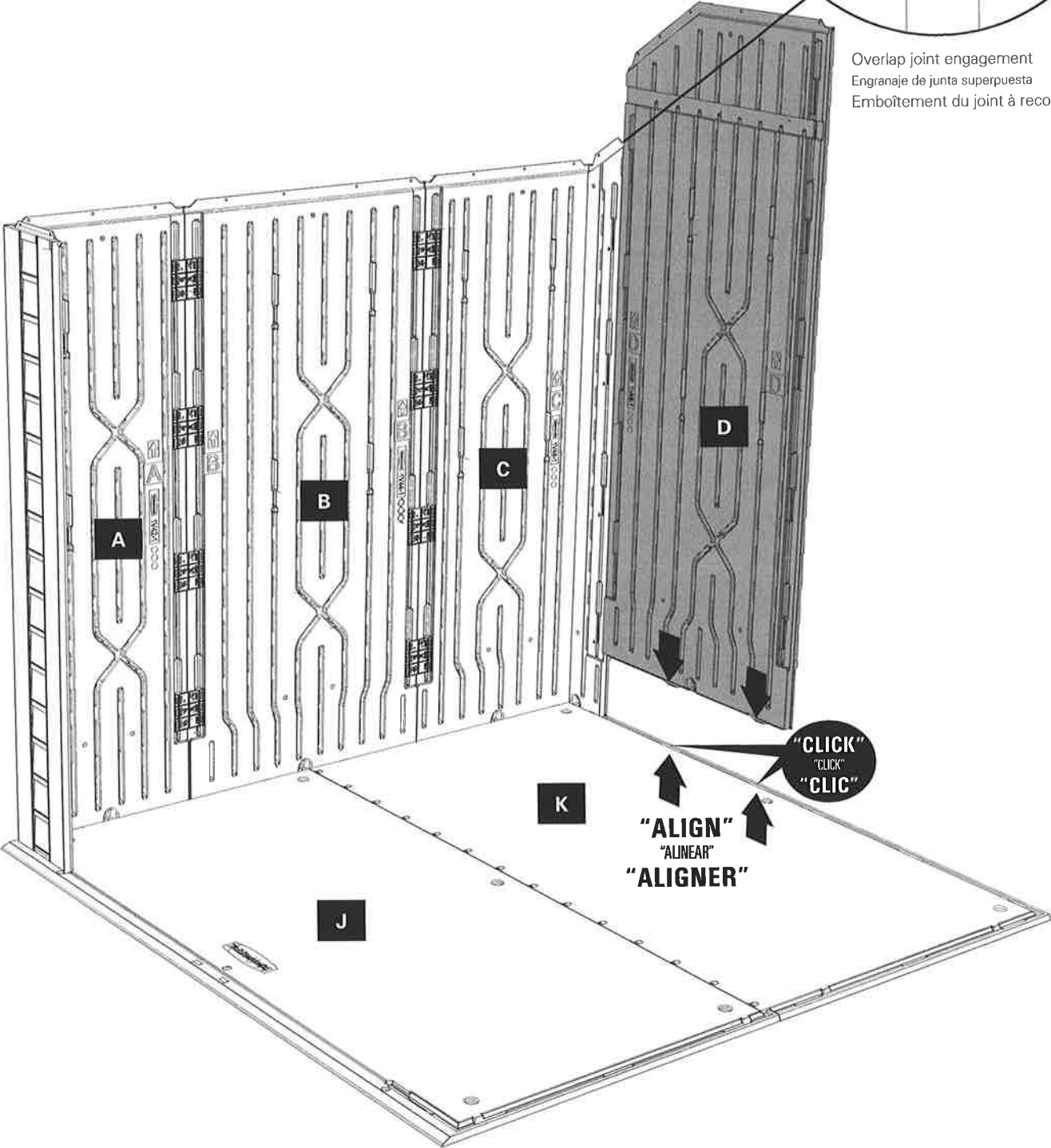

**"CLICK"**  
**"CLIC"**  
**"CLIC"**

**"ALIGN"**  
**"ALINEAR"**  
**"ALIGNER"**



# 6a

Continued.  
Continúa.  
Suite.

D installed into floor.

D instalada en el piso.

D installé dans le plancher.

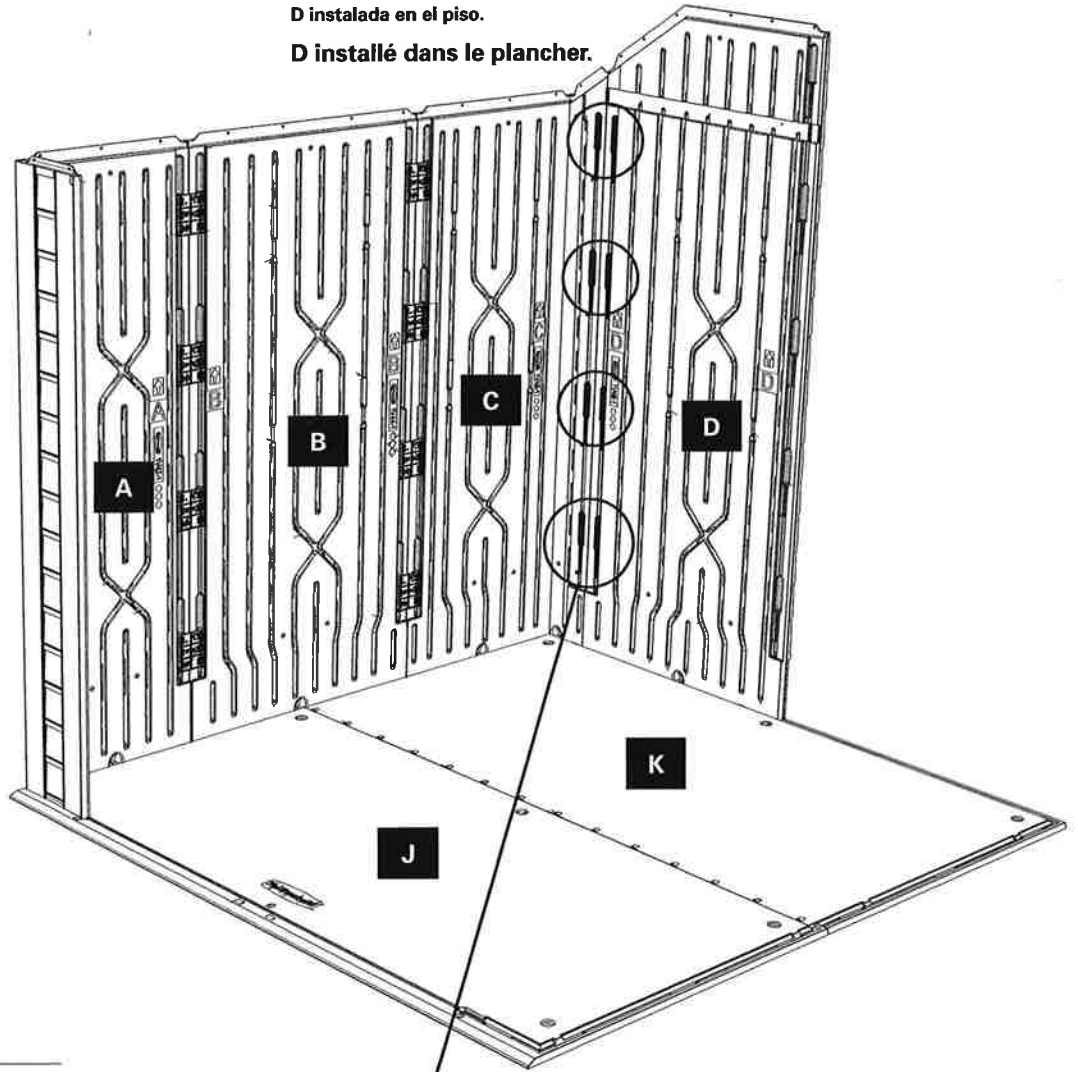

# 6b



WC 4

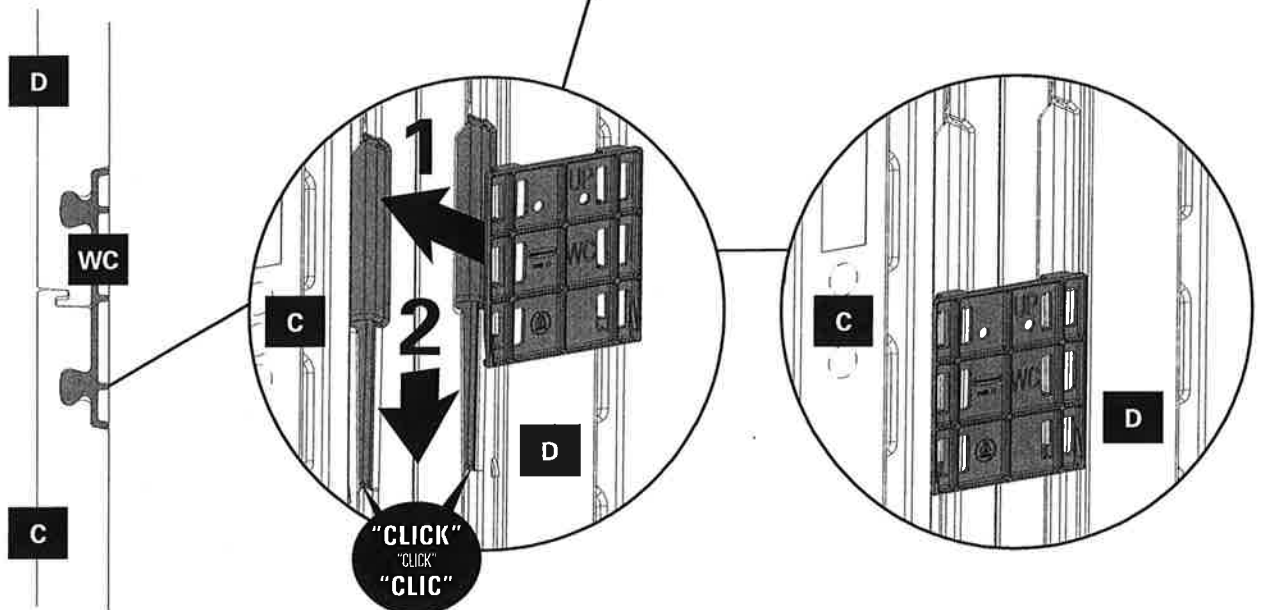

7a

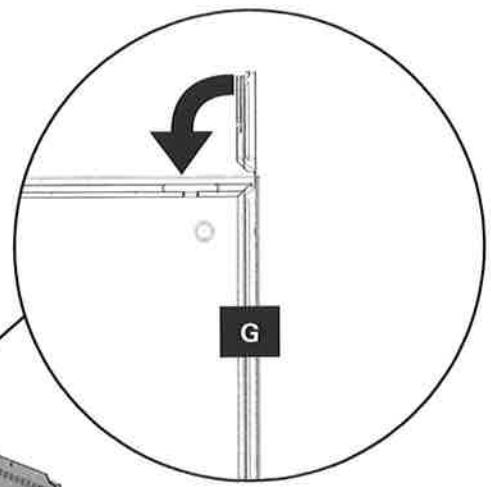
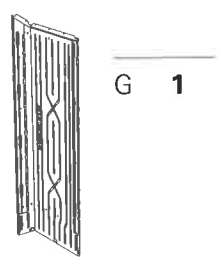

Top view  
Vista superior  
Vue d'en haut

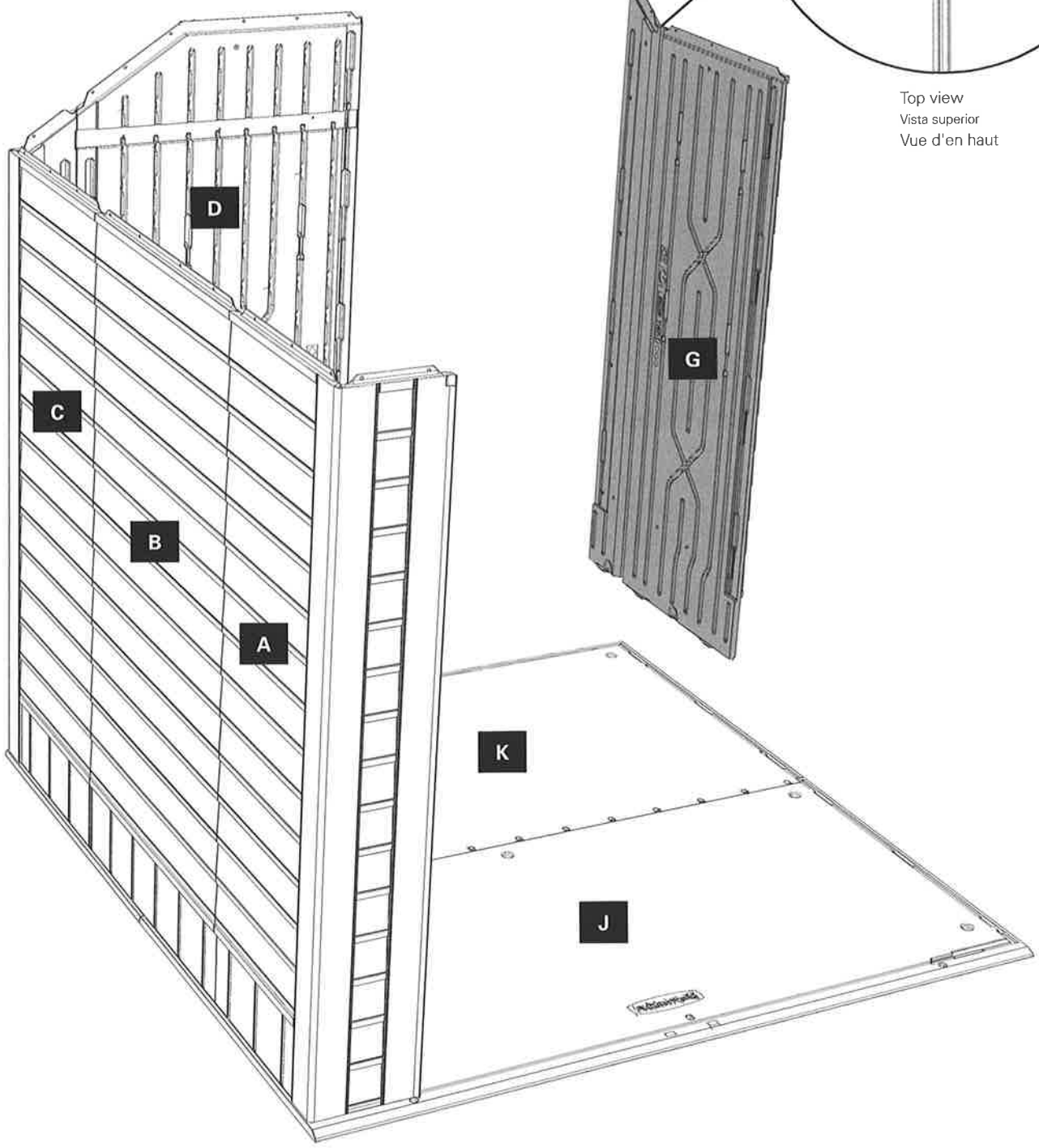

7b

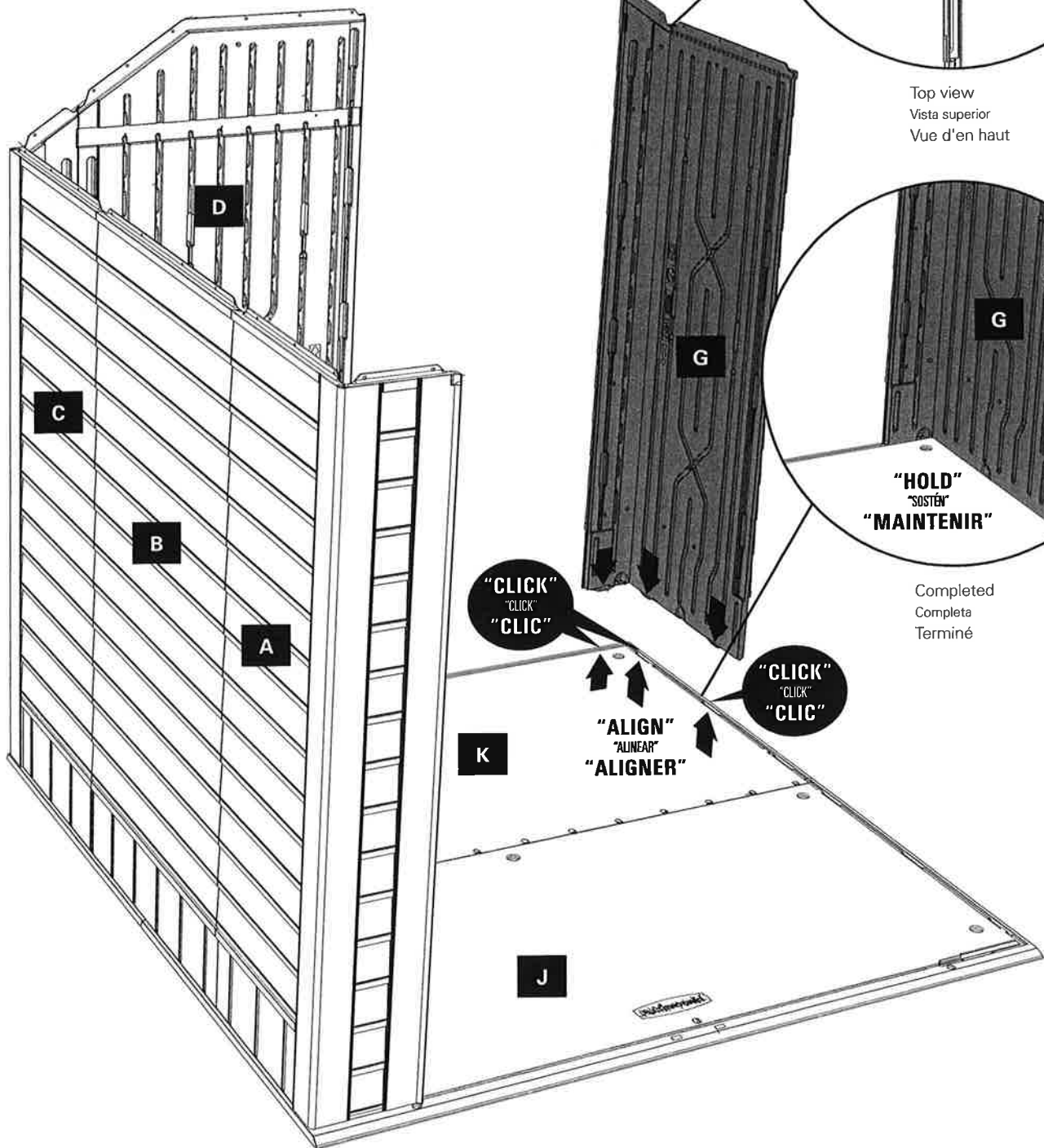

# 8a

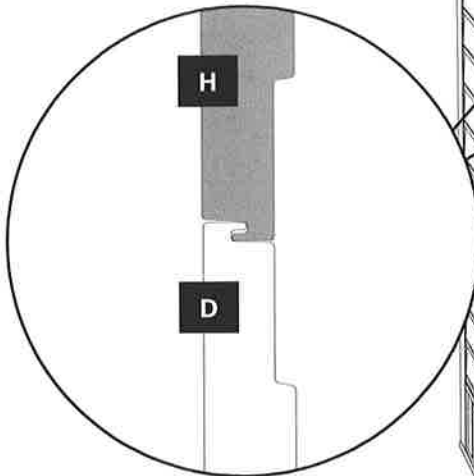
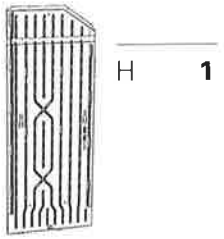

Overlap joint engagement  
 Engranaje de junta superpuesta  
 Emboîtement du joint à recouvrement

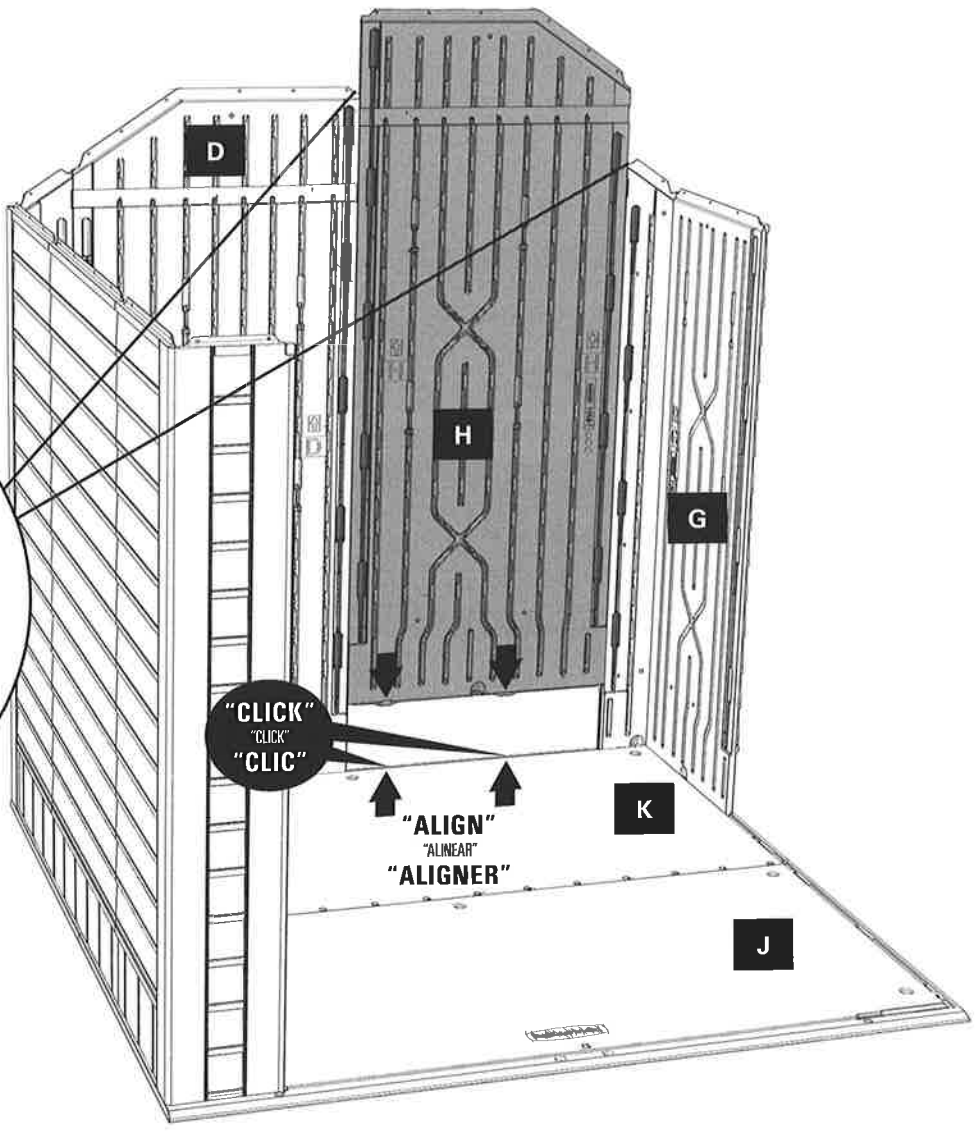

# 8b

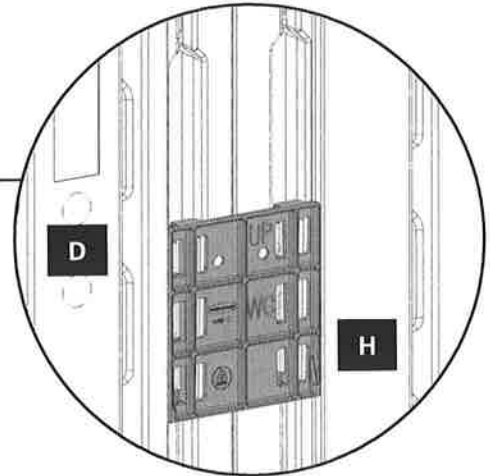
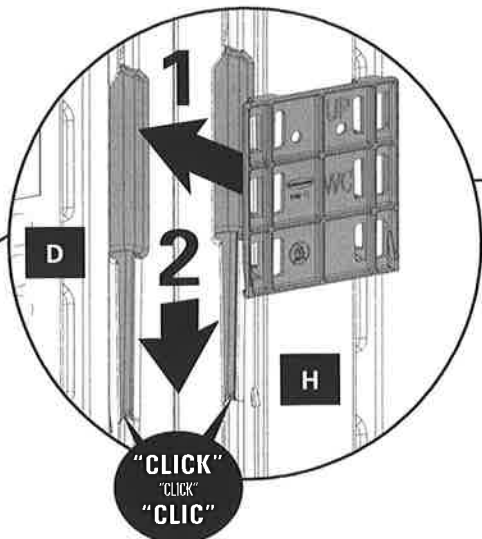

# 9a

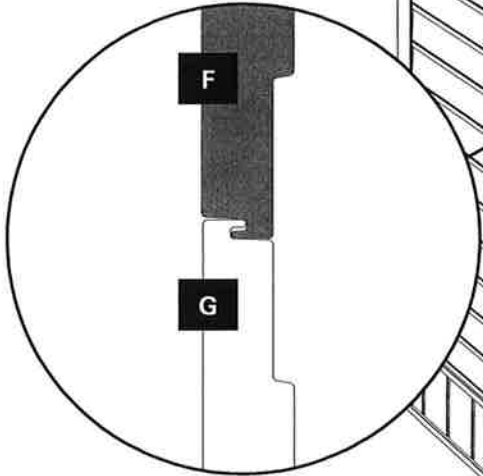
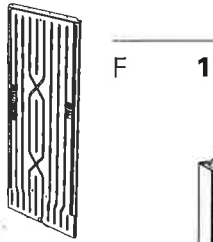

Overlap joint engagement  
Engranaje de junta superpuesta  
Emboîtement du joint à recouvrement

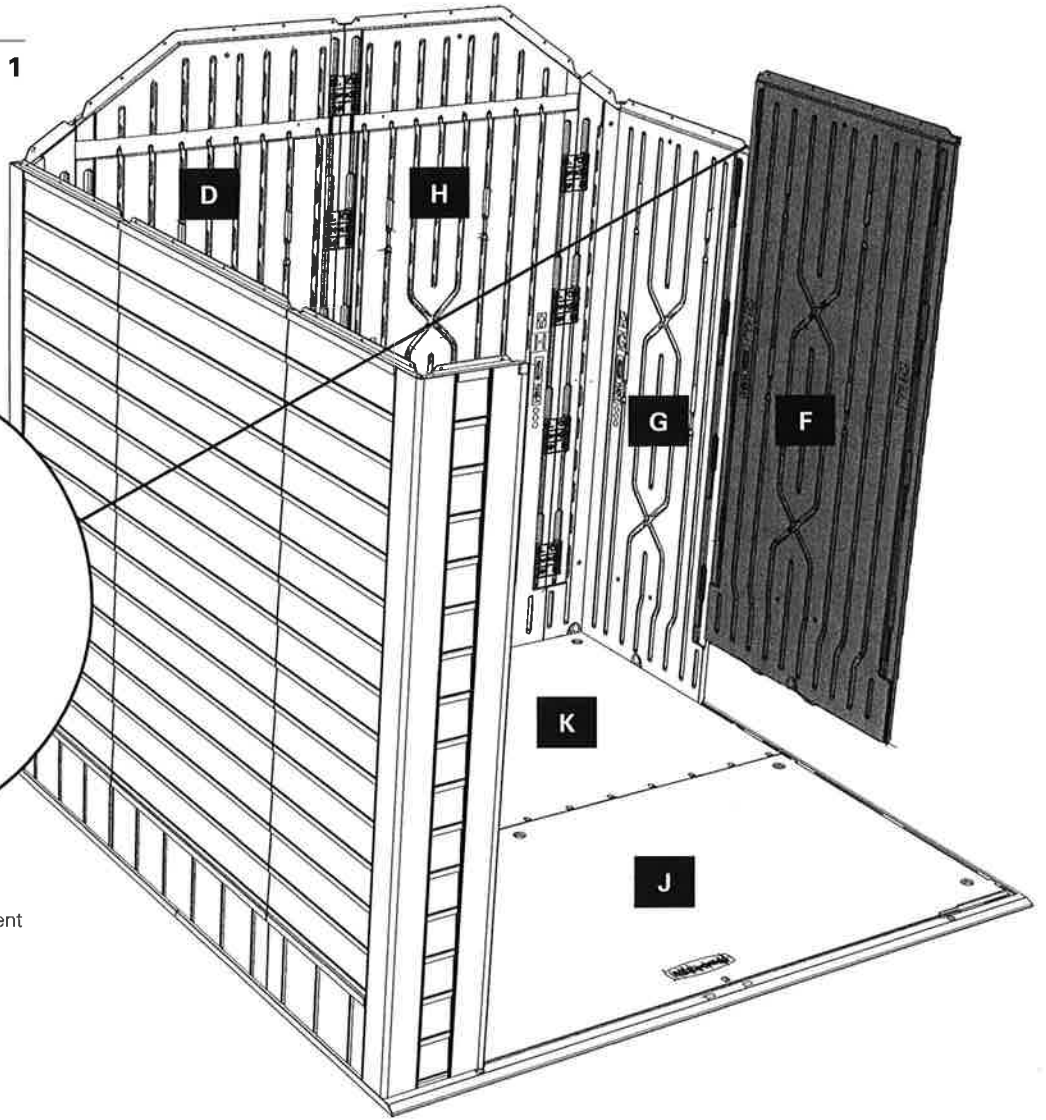

# 9b

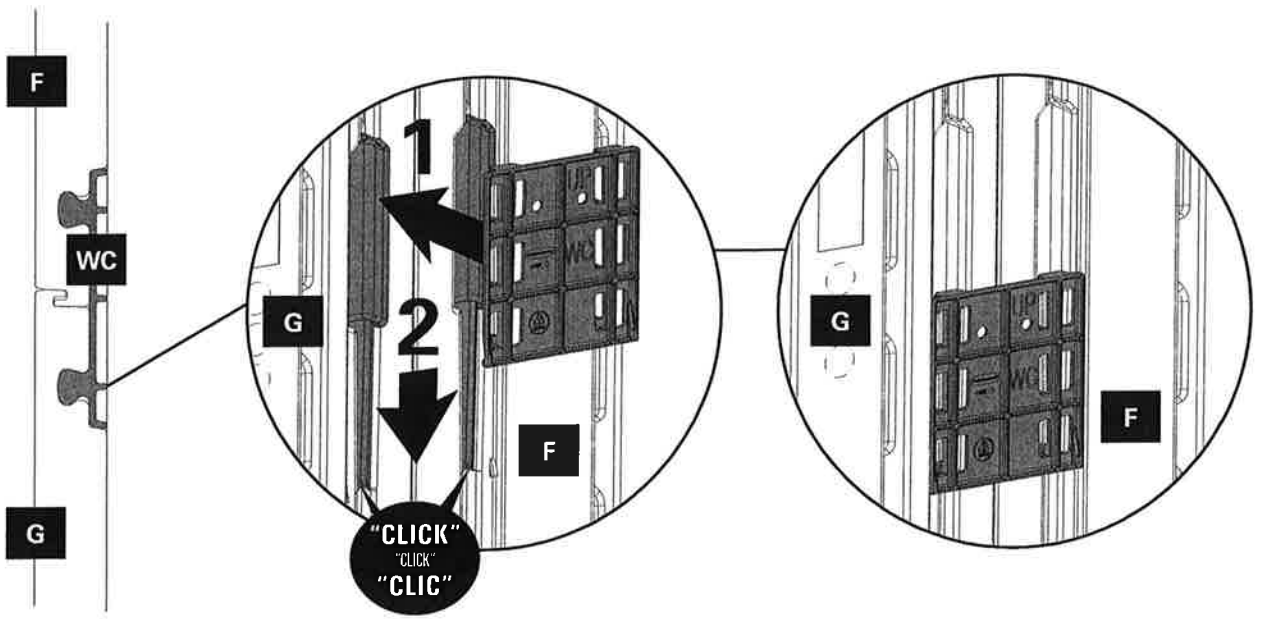

10a



E 1

Overlap joint engagement  
Engranaje de junta superpuesta  
Emboîtement du joint à recouvrement

Top view  
Vista superior  
Vue d'en haut

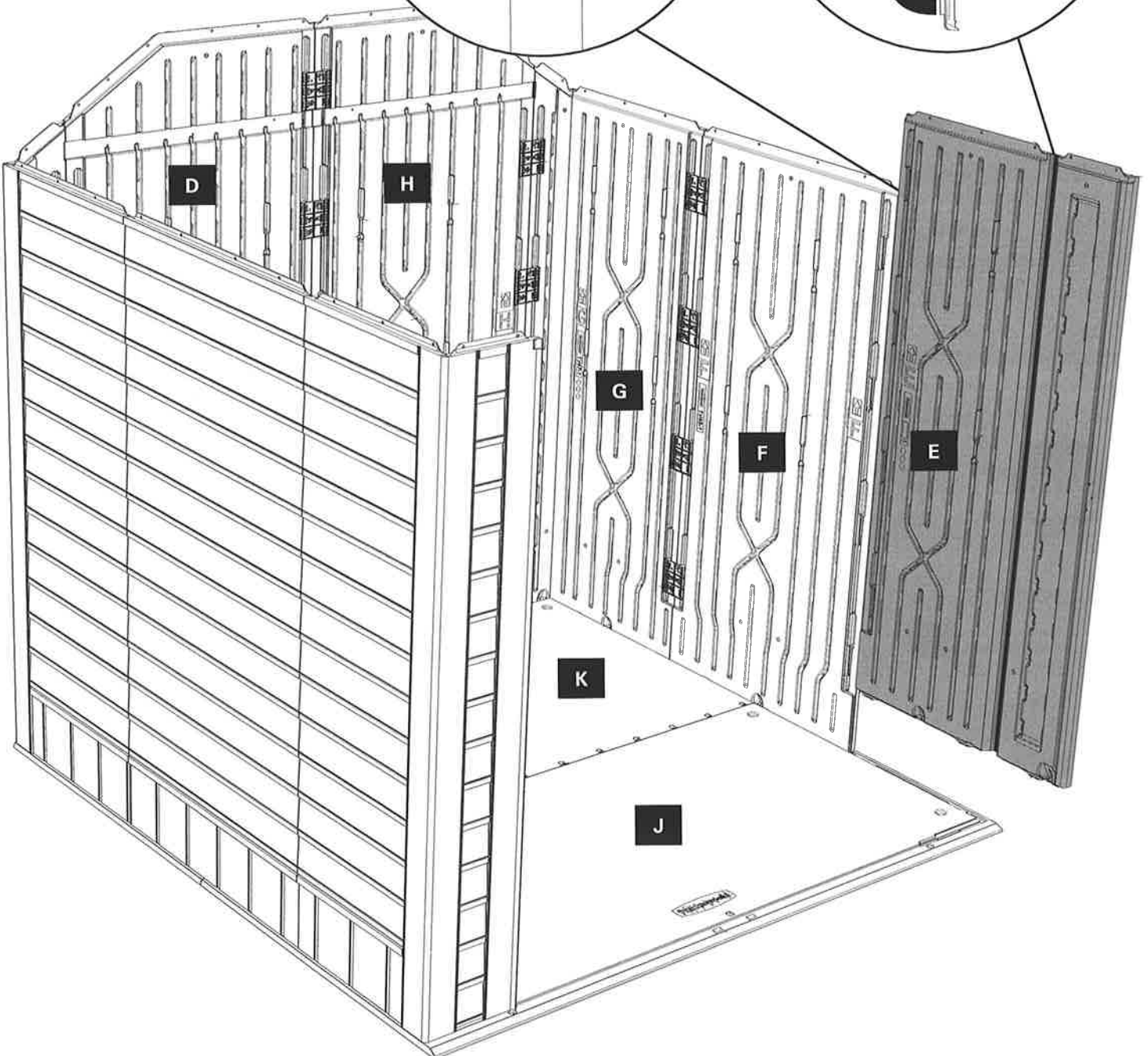
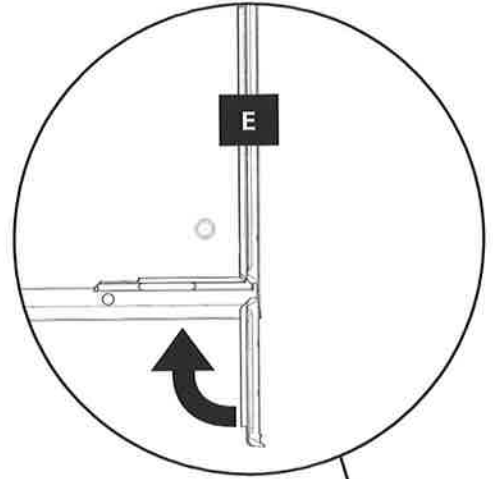
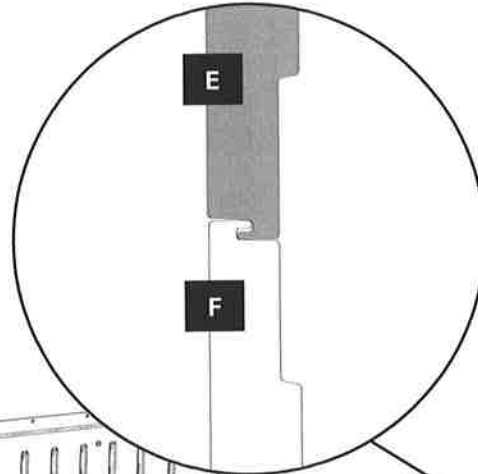



**10b**

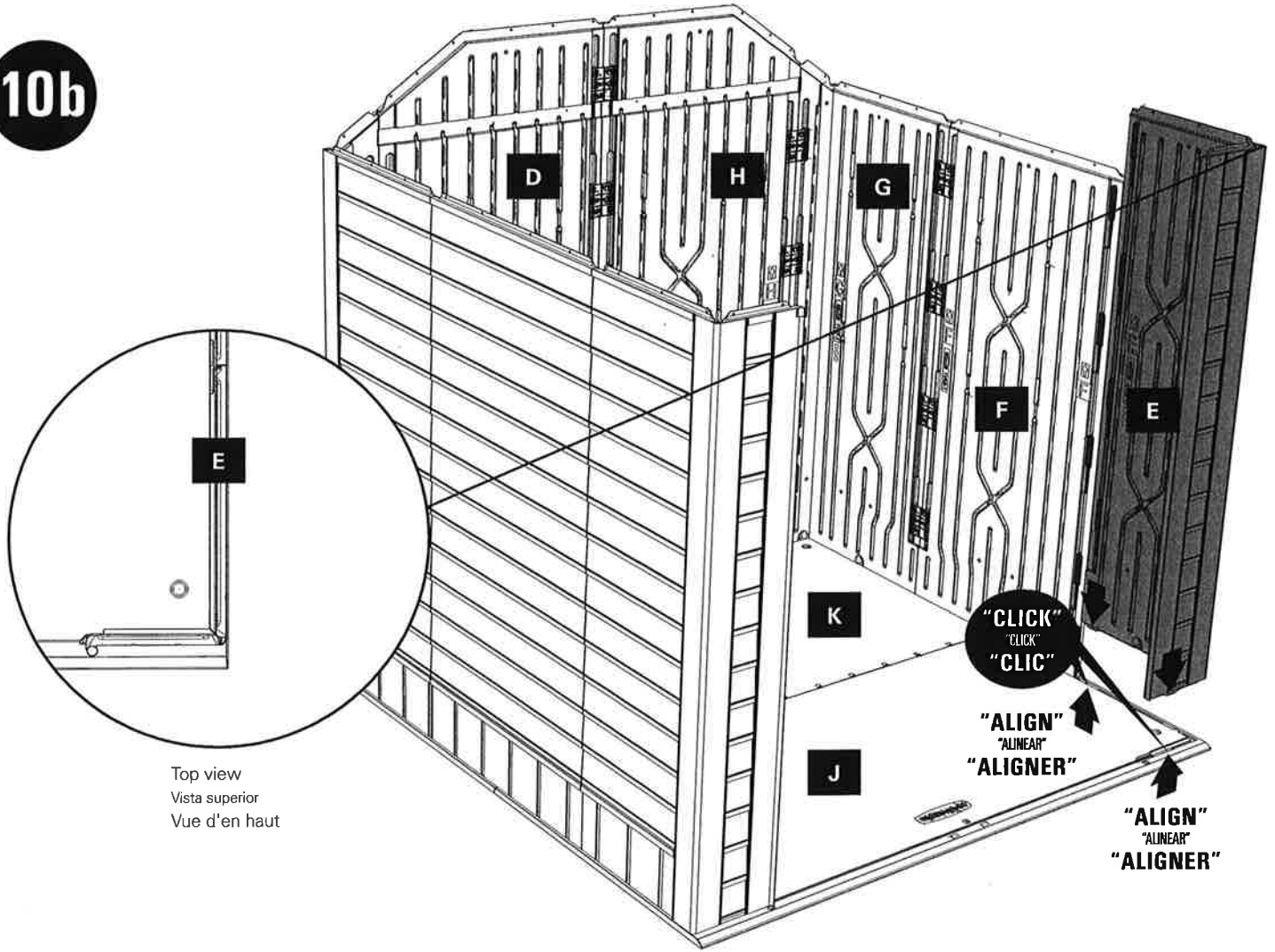

Top view  
Vista superior  
Vue d'en haut

**10c**



WC 4

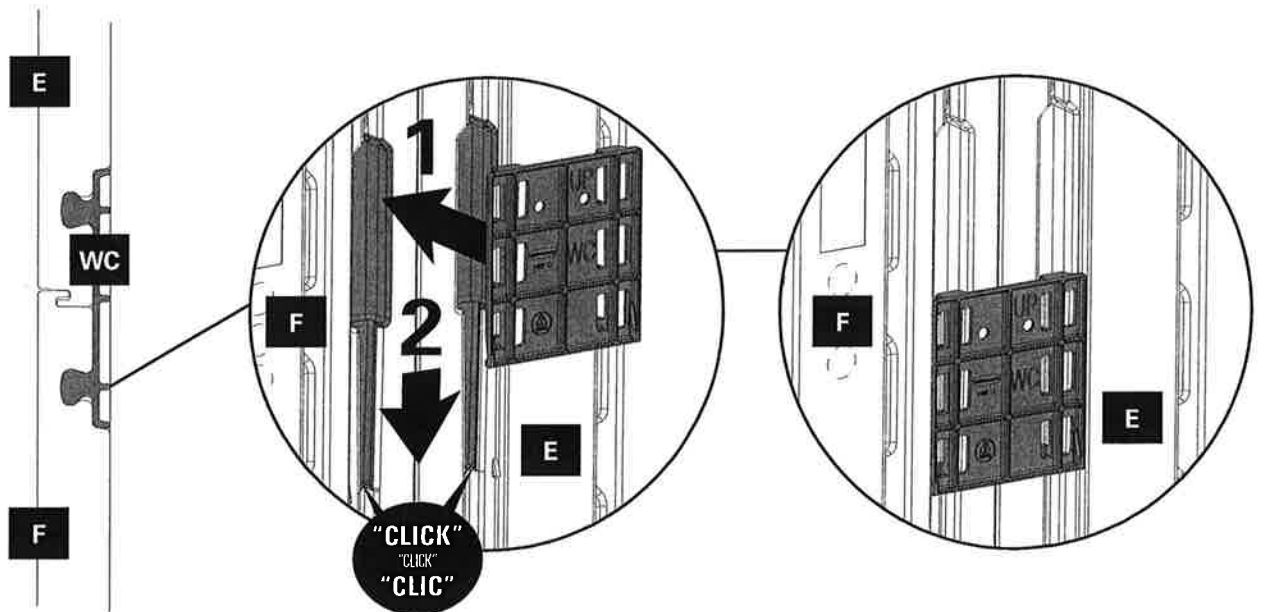

# 11a

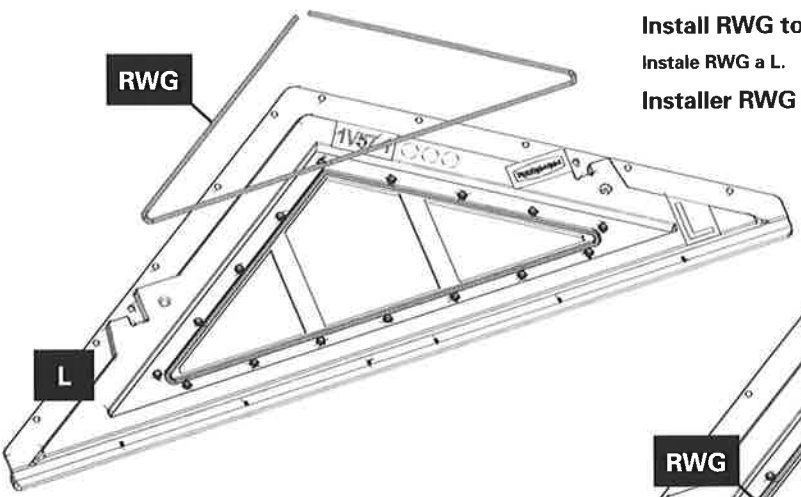

Install RWG to L.  
Instale RWG a L.  
Installer RWG avec L.

RWG in place.  
RWG en su lugar.  
RWG en place.

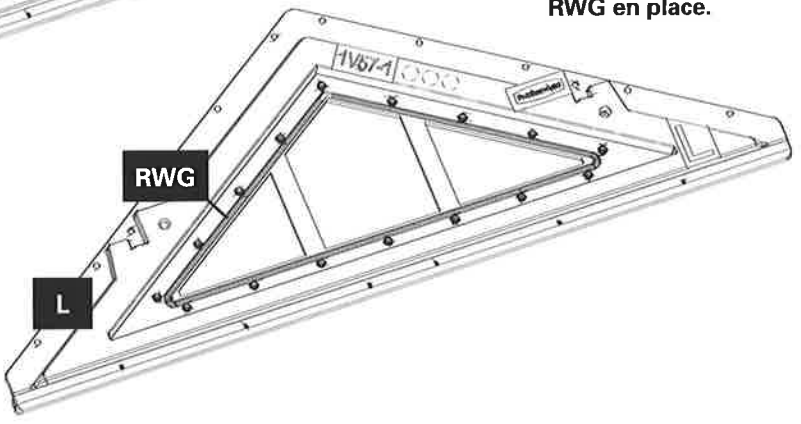

# 11b

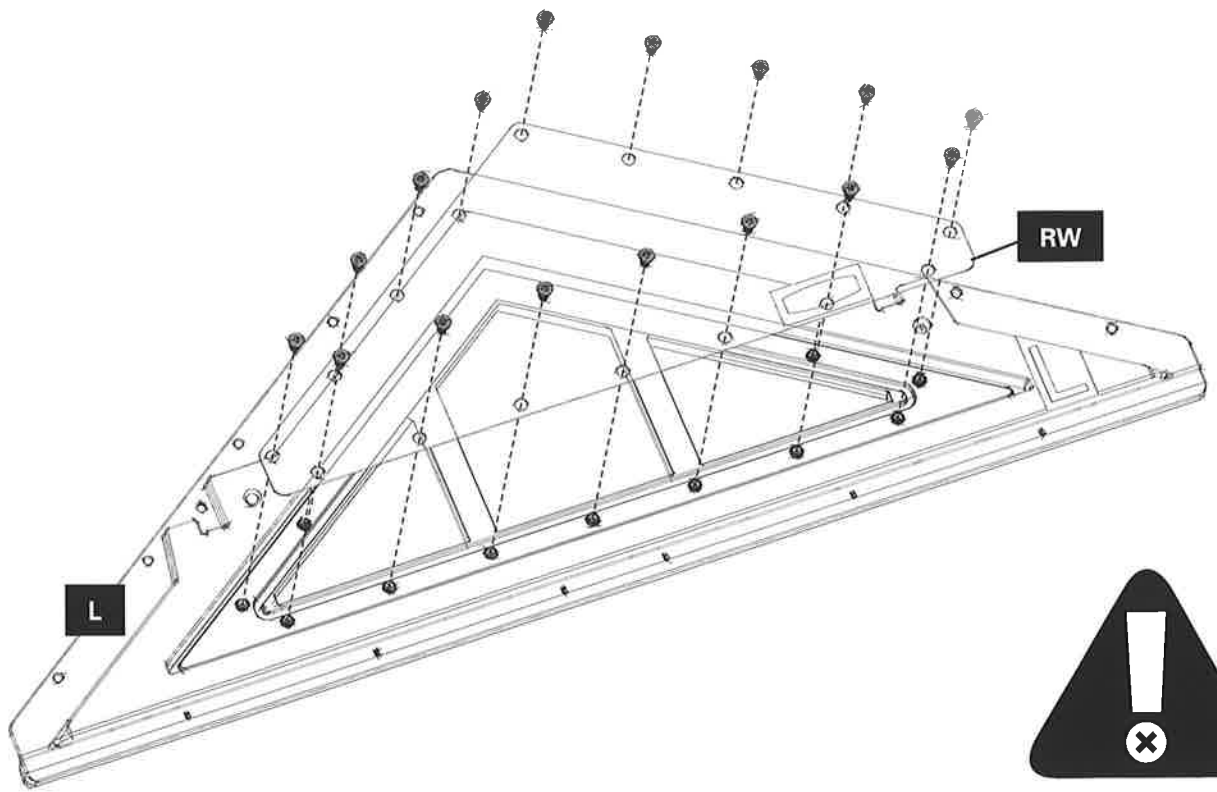
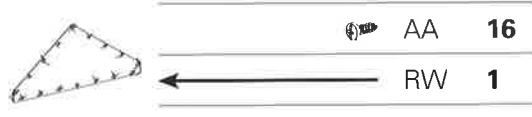



11c



L 1

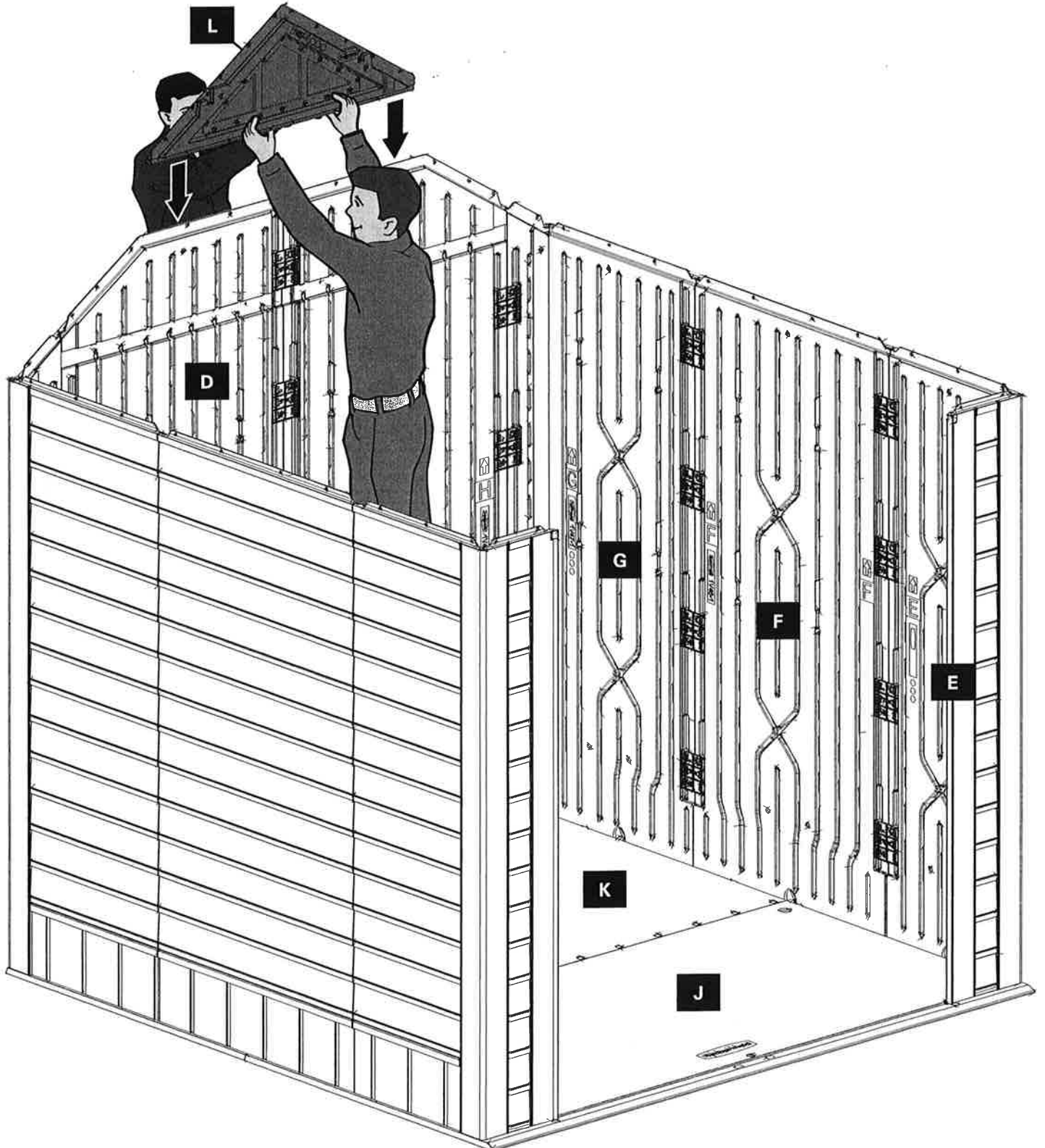

# 11c

AA 6

Continued.  
Continúa.  
Suite.

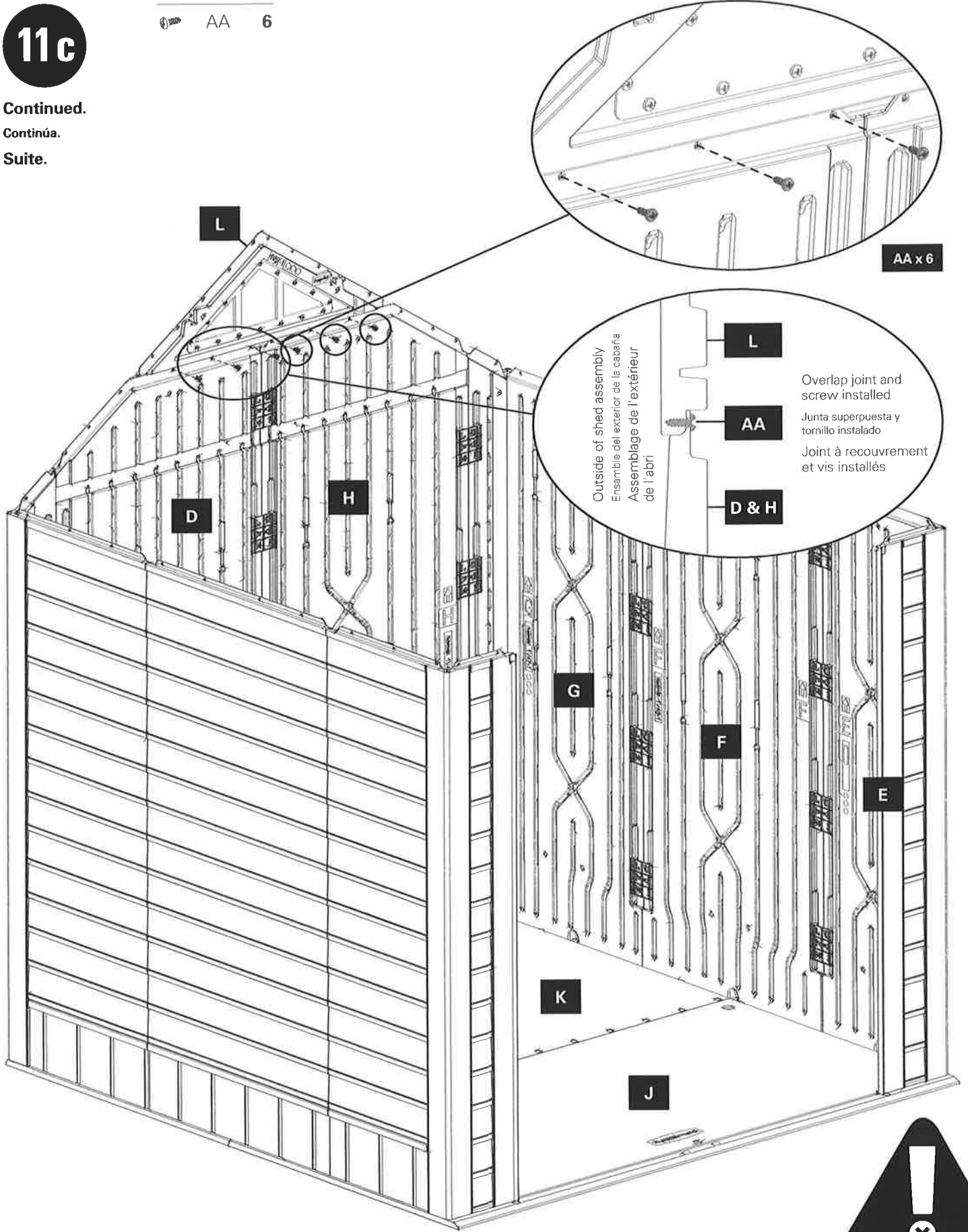

12a

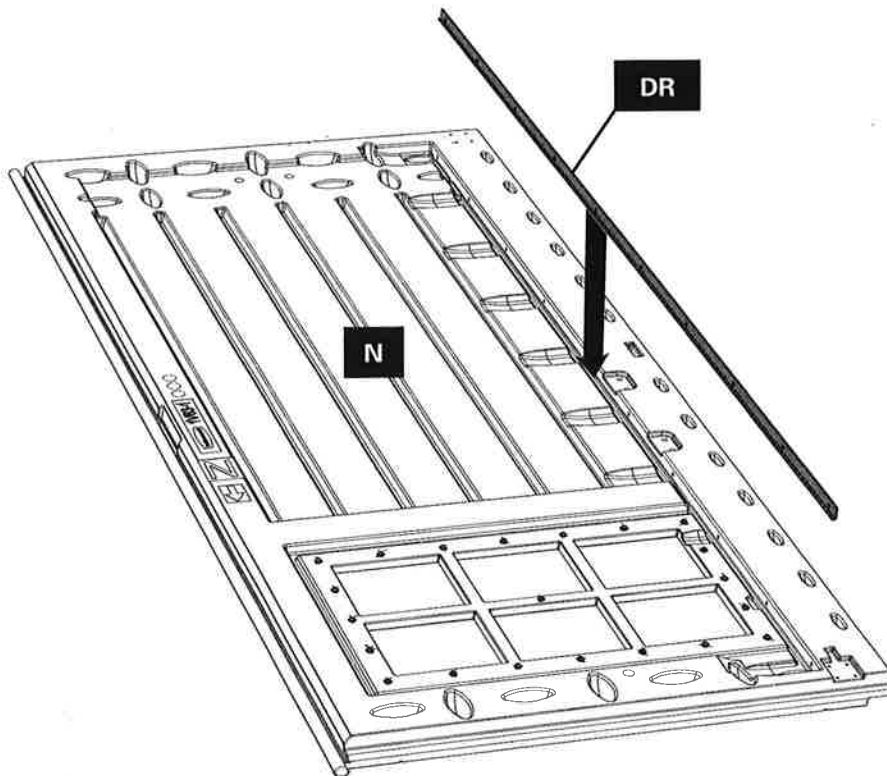

12a

Continued.  
Continúa.  
Suite.

BB 10

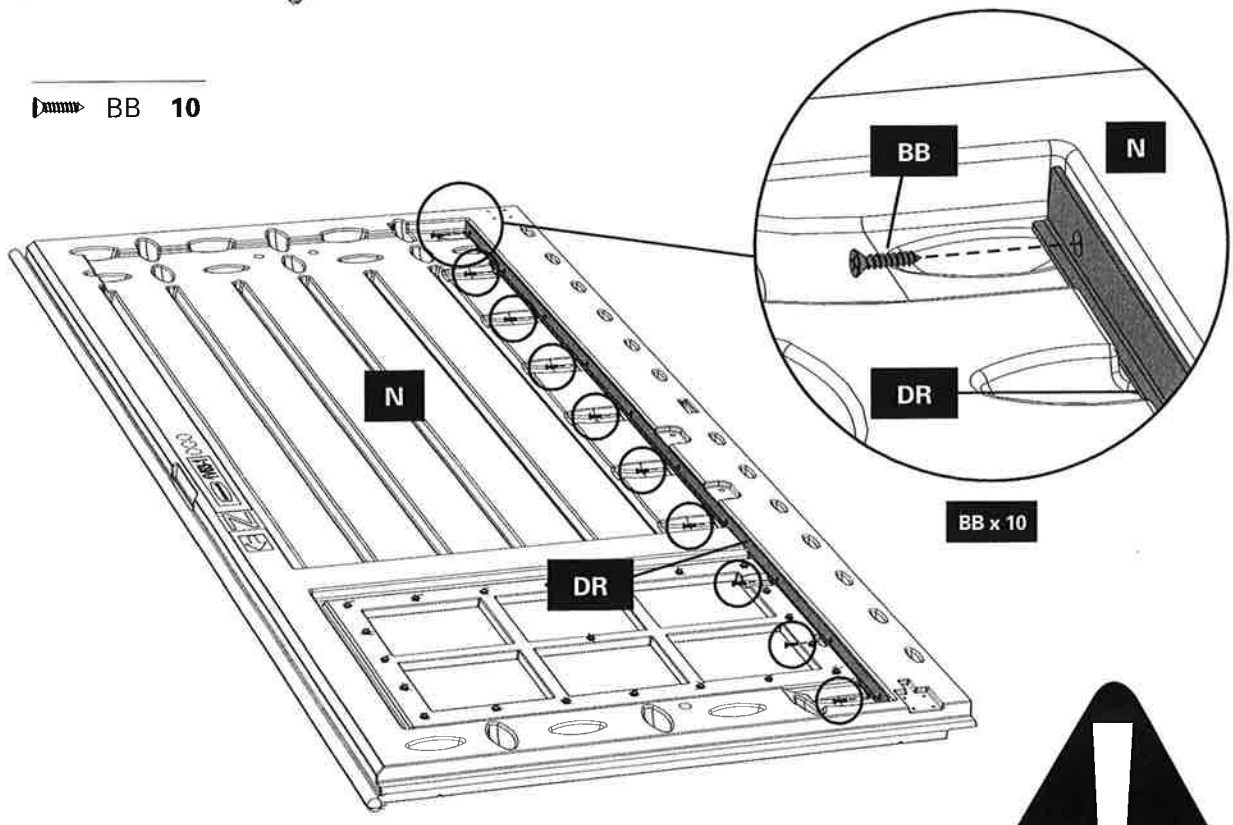

12b

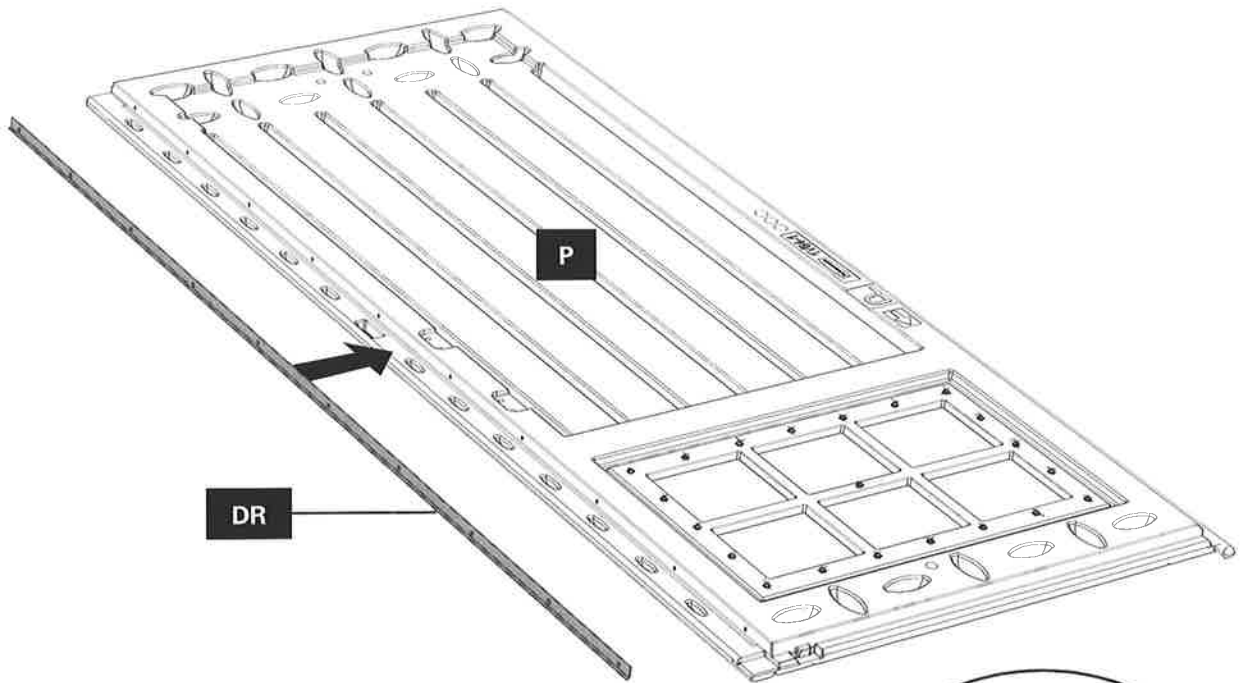

12b

Continued.  
Continúa.  
Suite.

BB 10

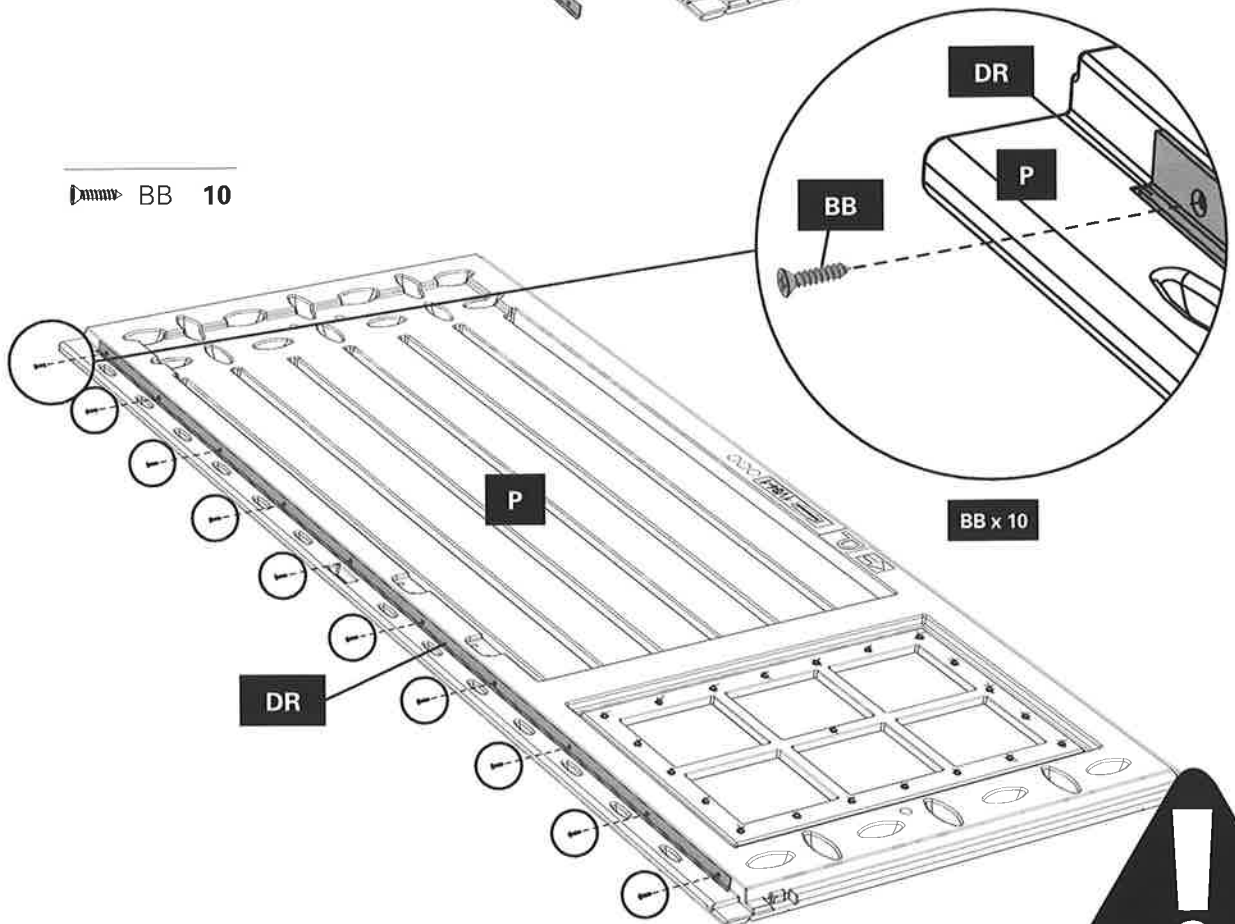

# 13a



Repeat steps 13a–13b for other DWF.  
Repita los paso 13a a 13b para otro DWF.  
Répéter les étapes 13a-13b pour d'autres DWF.

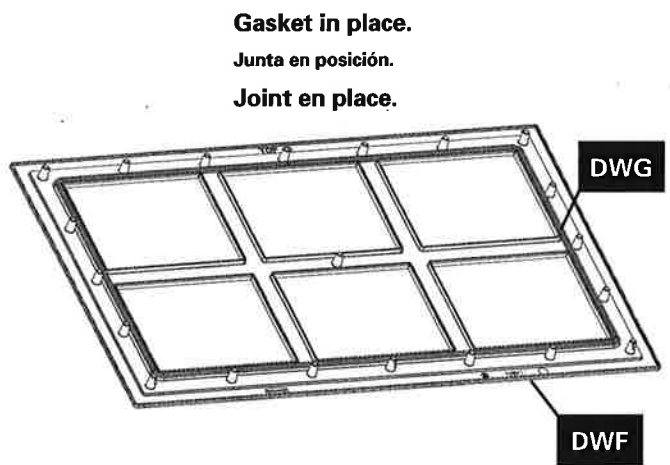
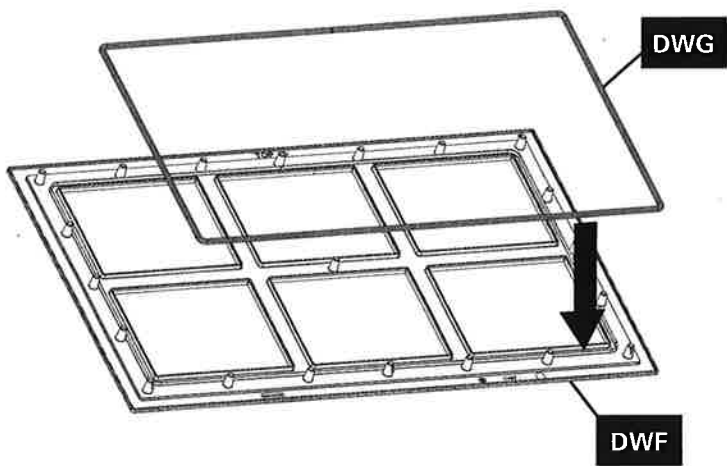

Gasket in place.  
Junta en posición.  
Joint en place.

# 13b

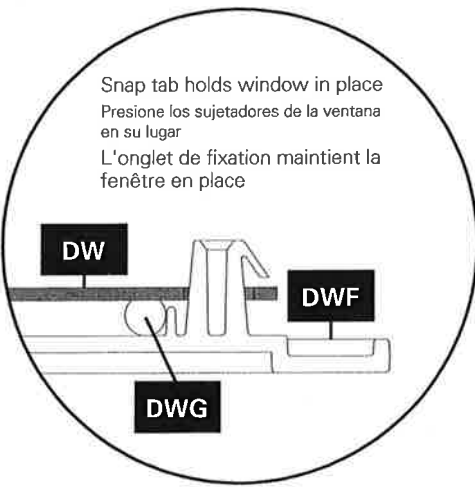
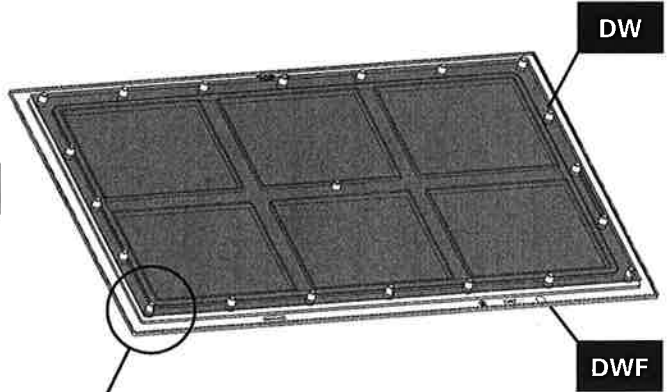
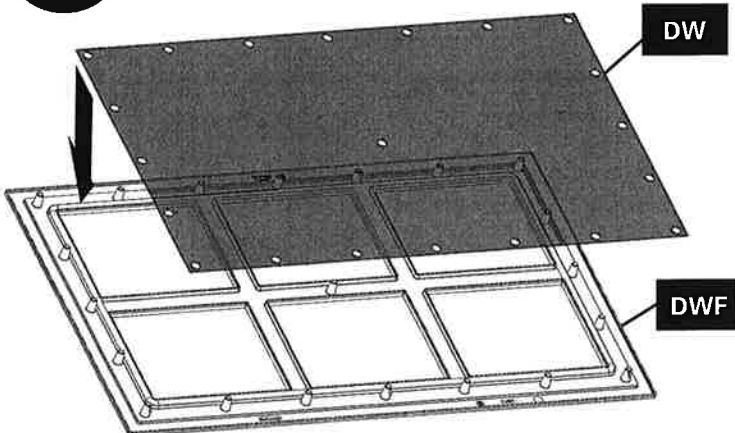

Snap tab holds window in place  
Presione los sujetadores de la ventana en su lugar  
L'onglet de fixation maintient la fenêtre en place

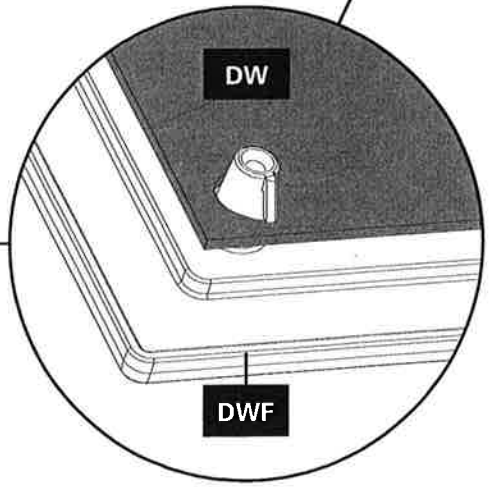

13c



N 1



DW 1



DWG 1



DWF 1

CC 19

JJ 19

Repeat for right door P.

Repita para puerta derecha P.

Répéter l'opération pour la porte de droite P.

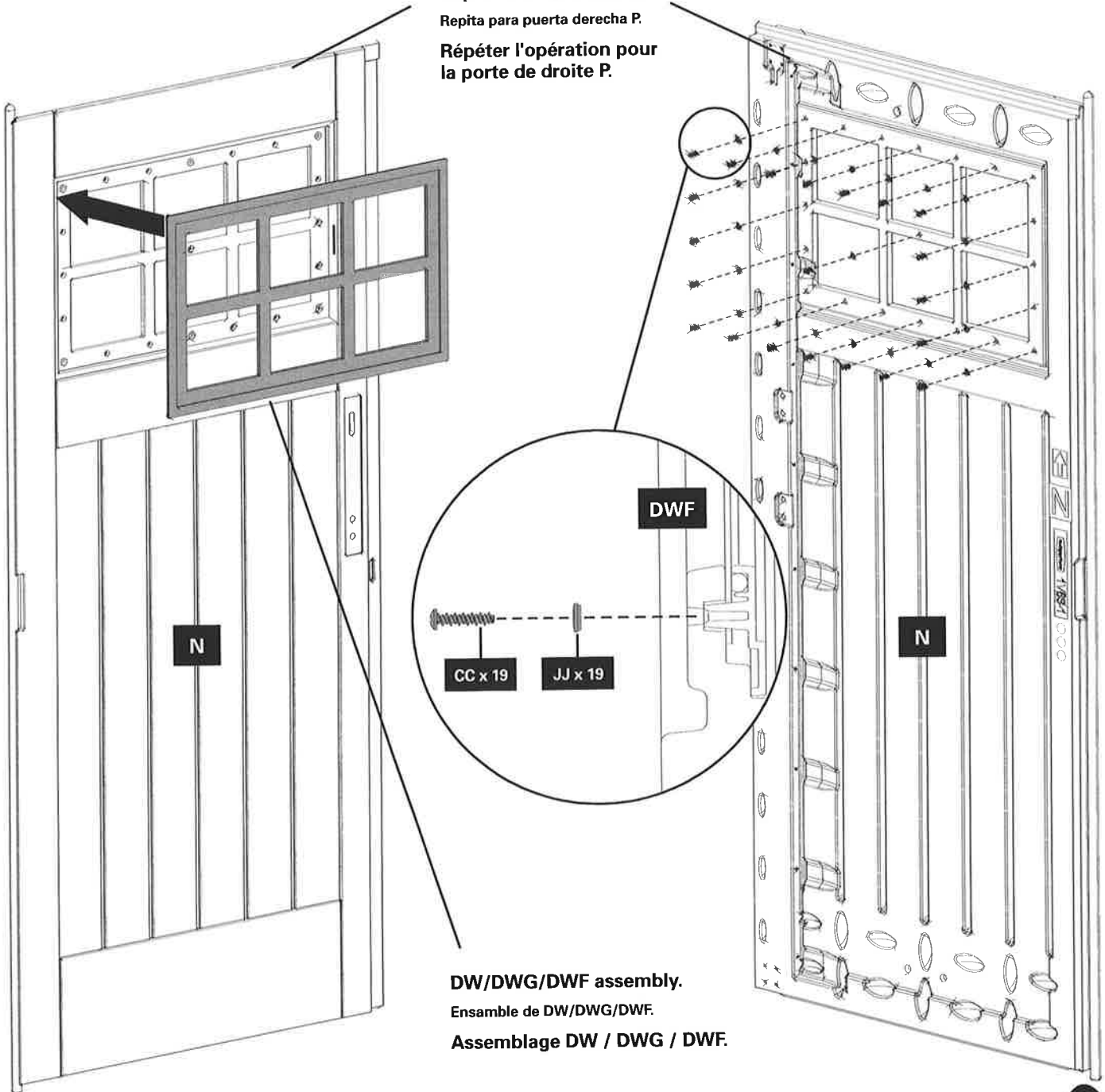

DW/DWG/DWF assembly.

Ensamble de DW/DWG/DWF.

Assemblage DW / DWG / DWF.



**13c**

**Continued.**

**Continúa.**

**Suite.**

**Repeat for right door P.**

**Repita para puerta derecha P.**

**Répéter l'opération pour  
la porte de droite P.**

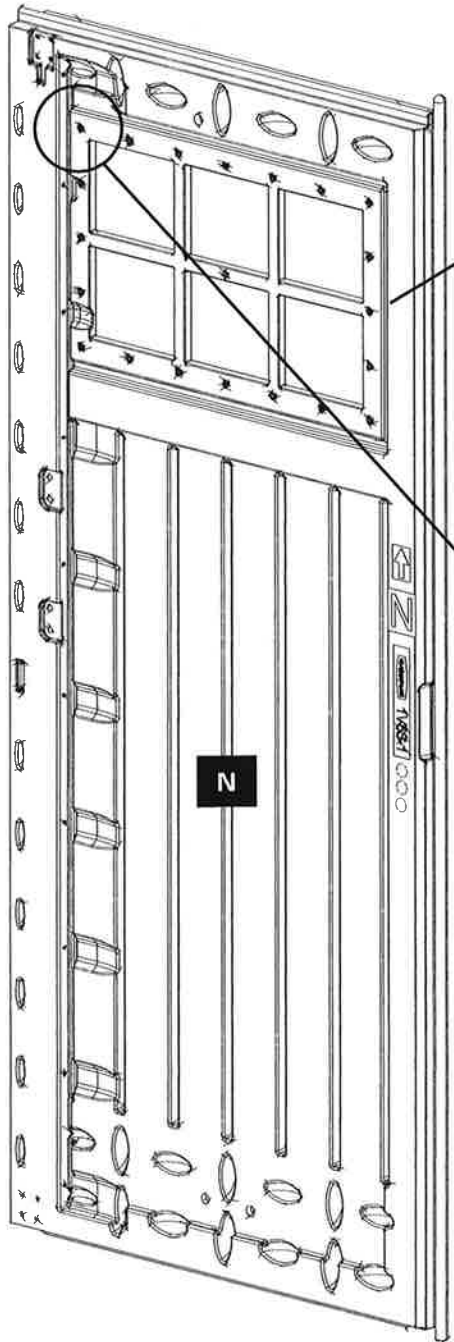

**DW/DWG/DWF assembly.**

**Ensamble de DW/DWG/DWF.**

**Assemblage DW / DWG / DWF.**

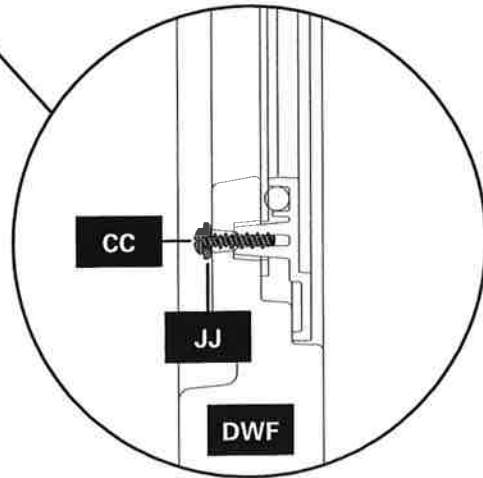

Section showing assembly complete

Sección que muestra el ensamble completo

Coupe montrant l'assemblage complet

14a

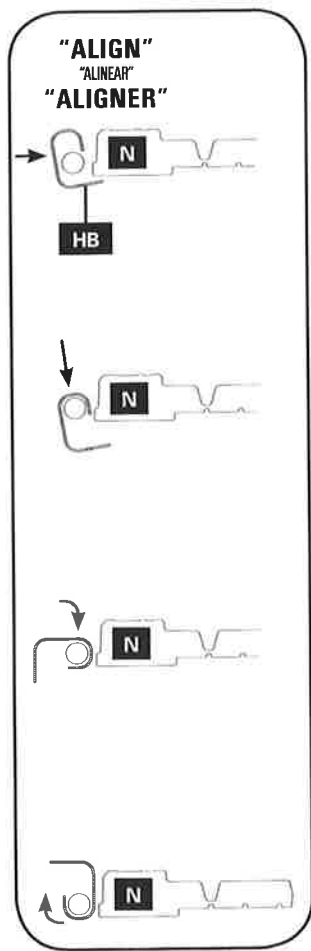
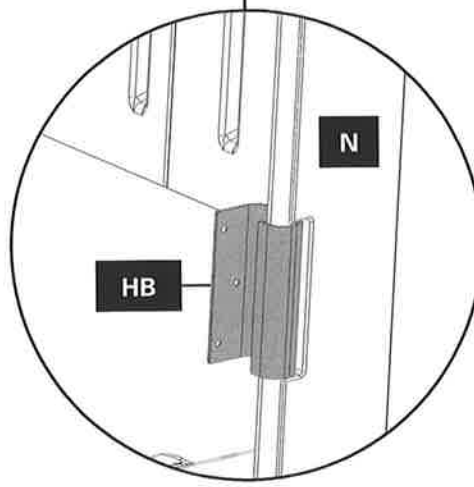
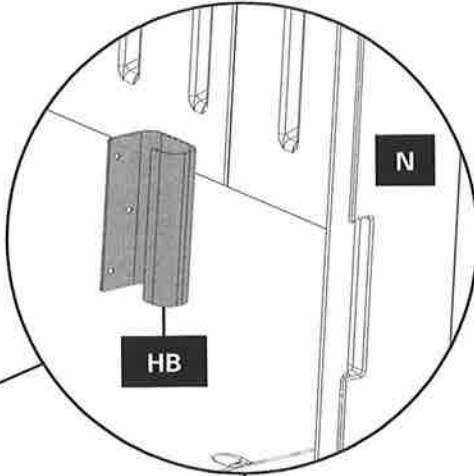
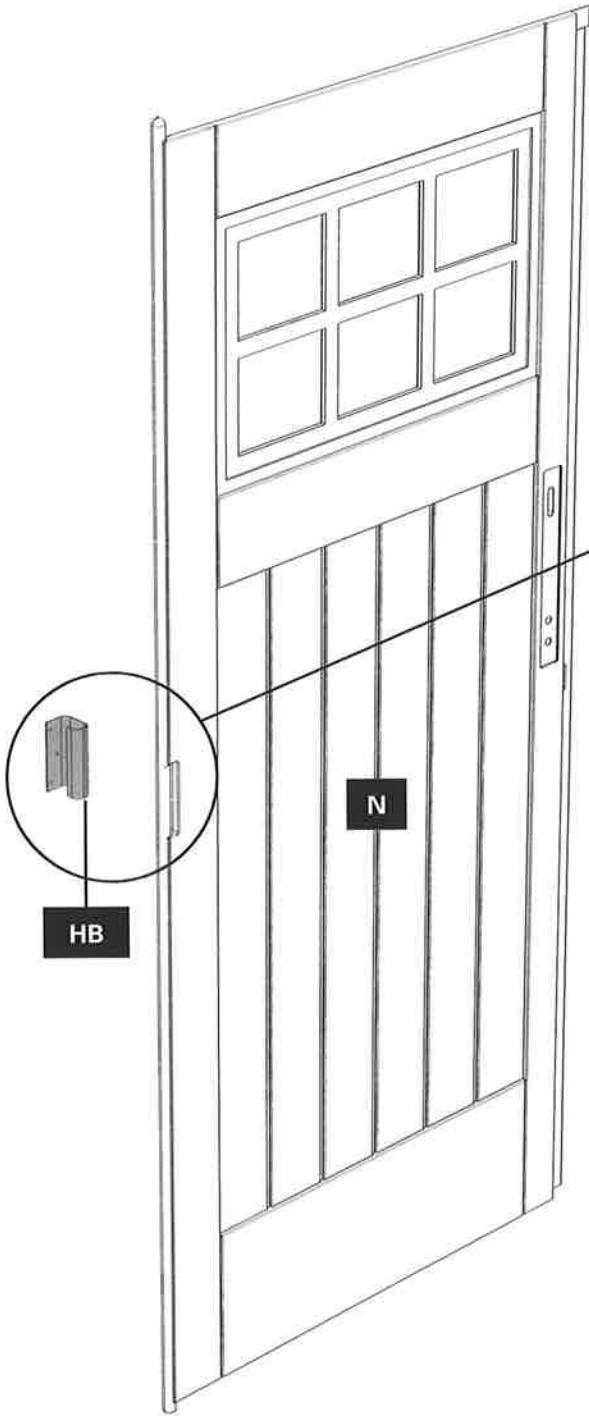
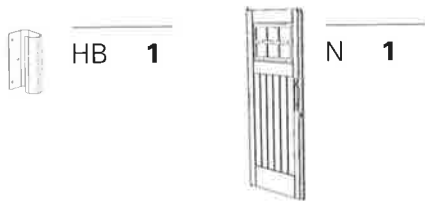



14b

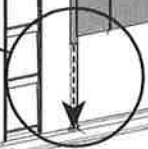
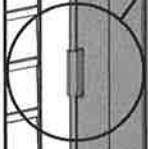
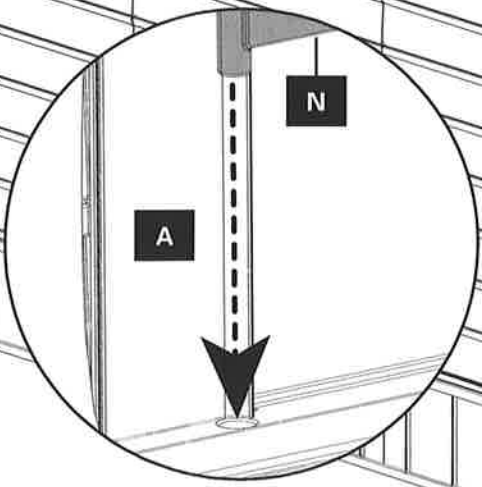
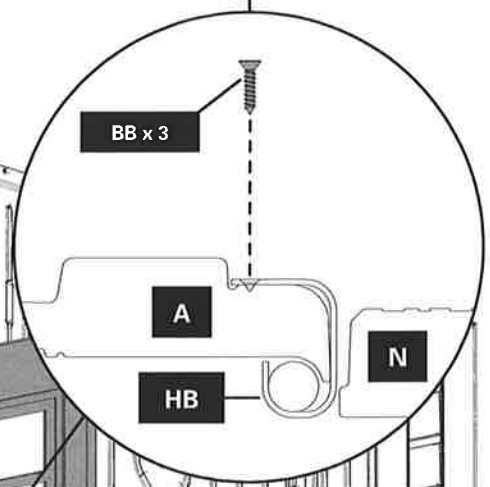
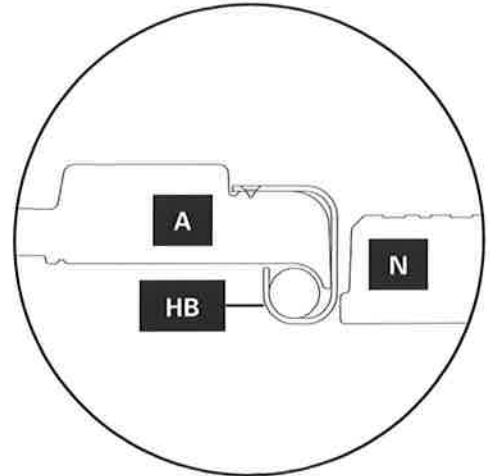
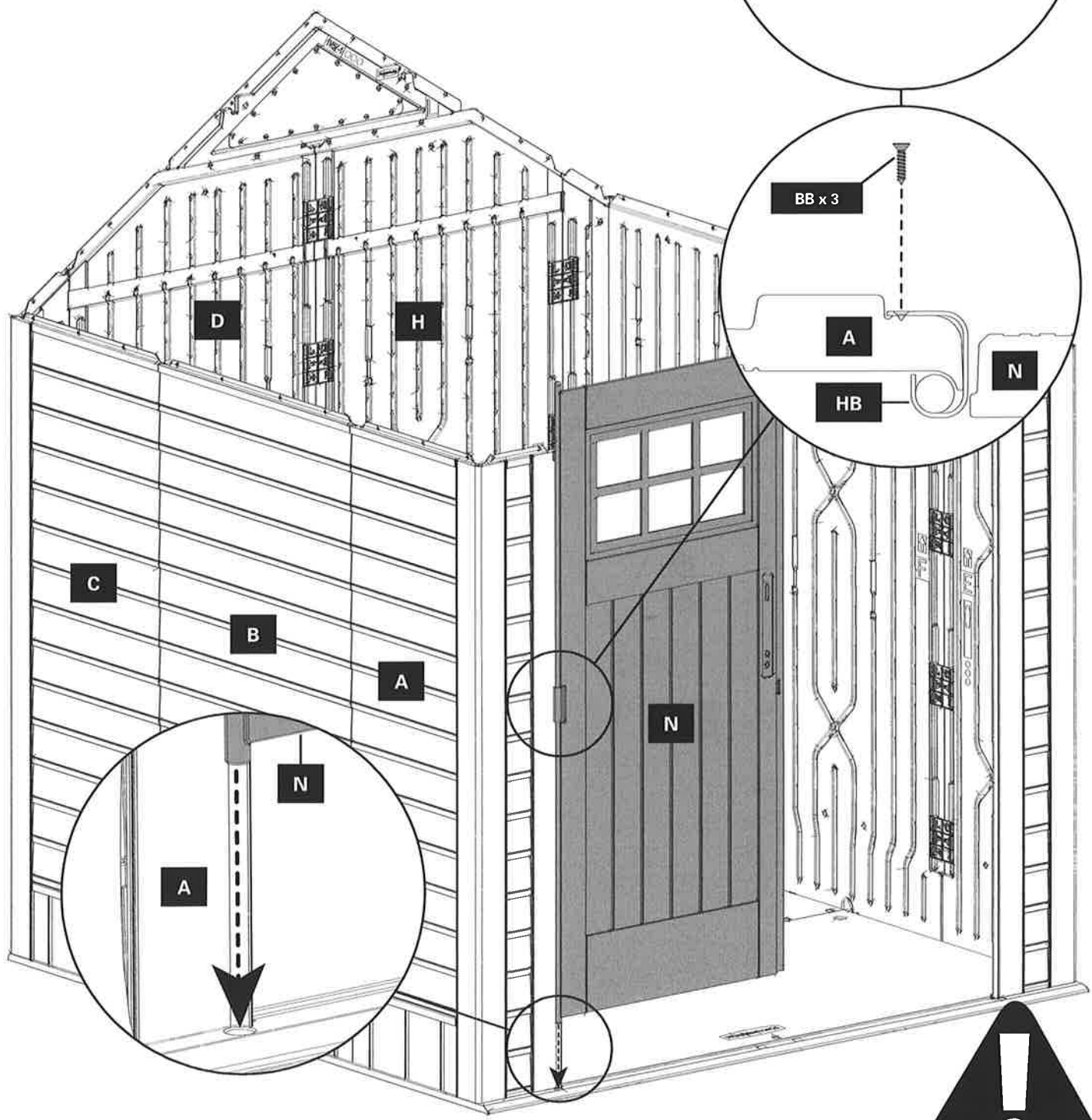
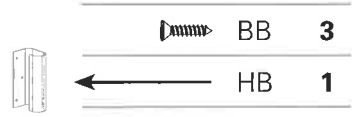

15a



HB 1



P 1

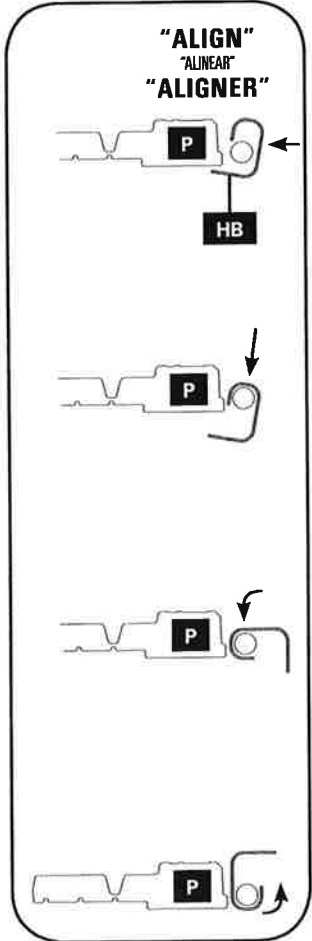
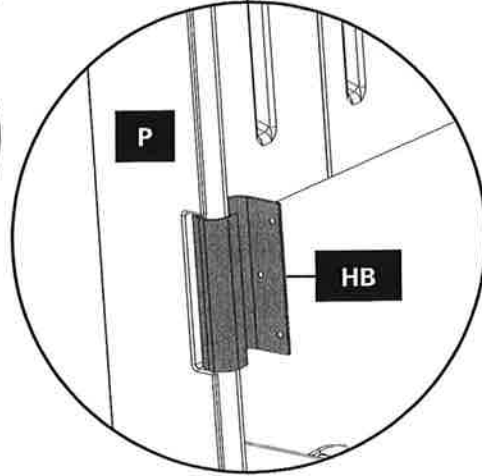
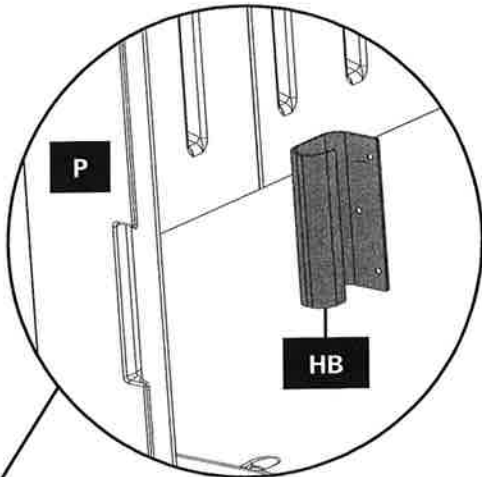
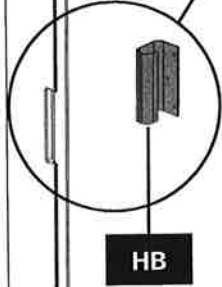
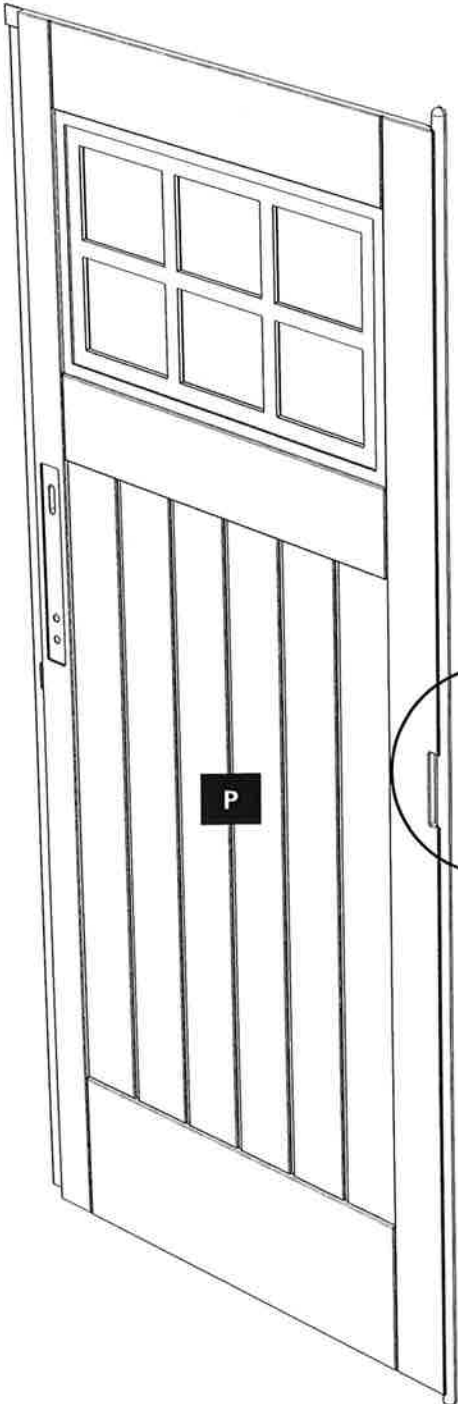



**15b**

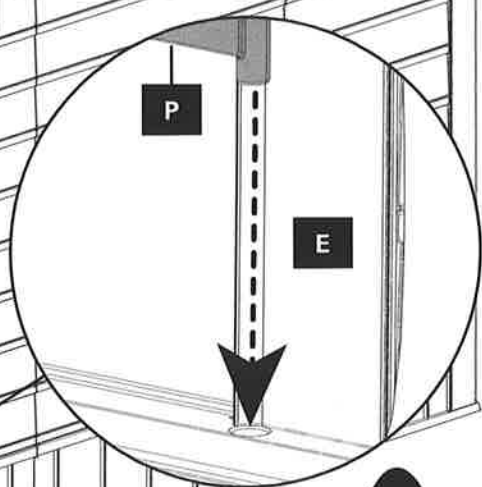
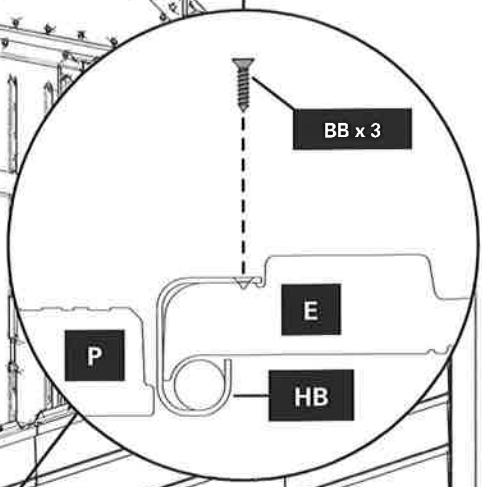
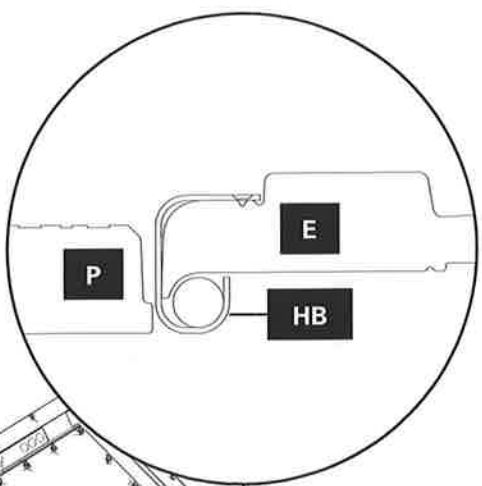
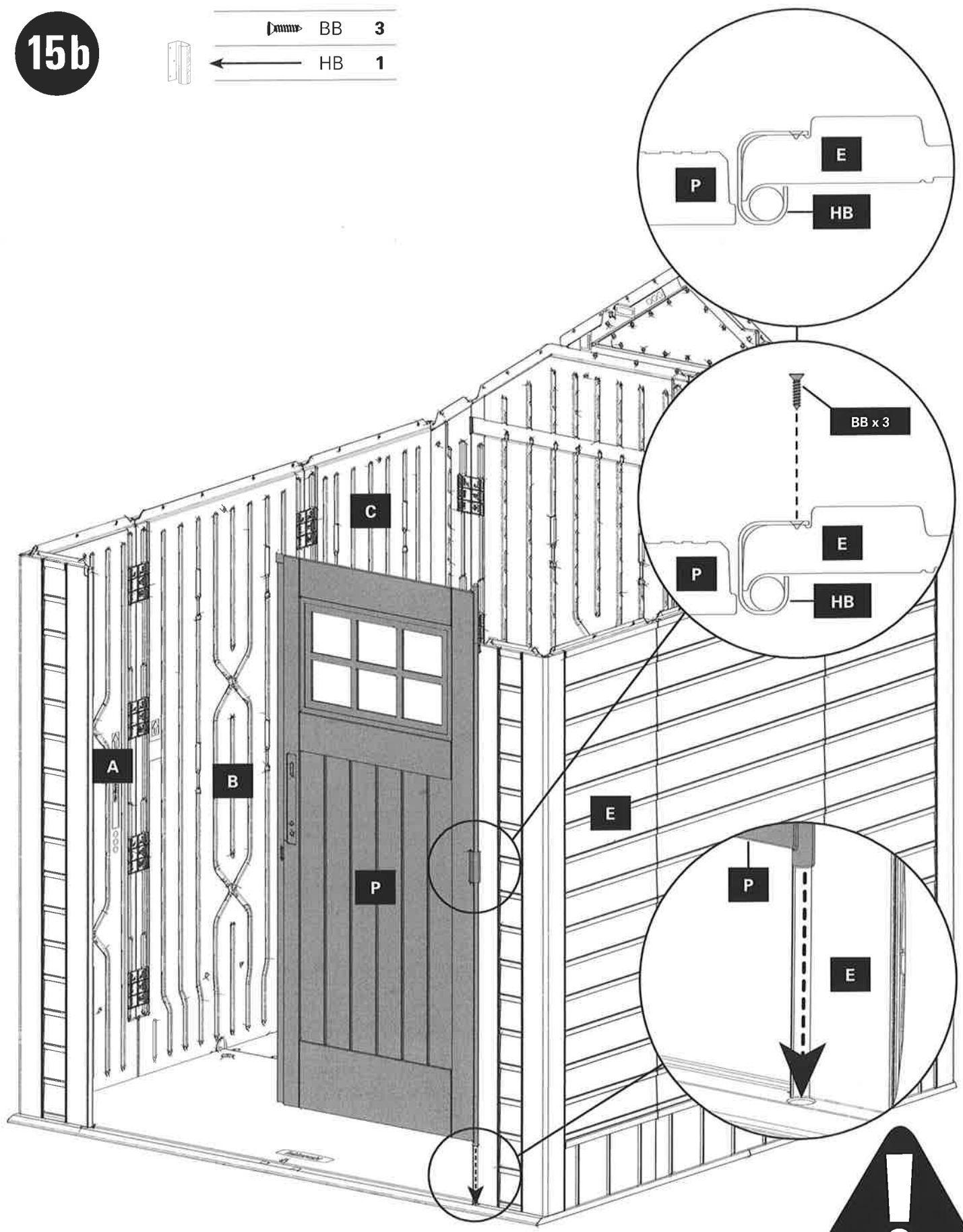

	BB	3
	HB	1



16a

-  AA 6
-  HD 1
-  M 1

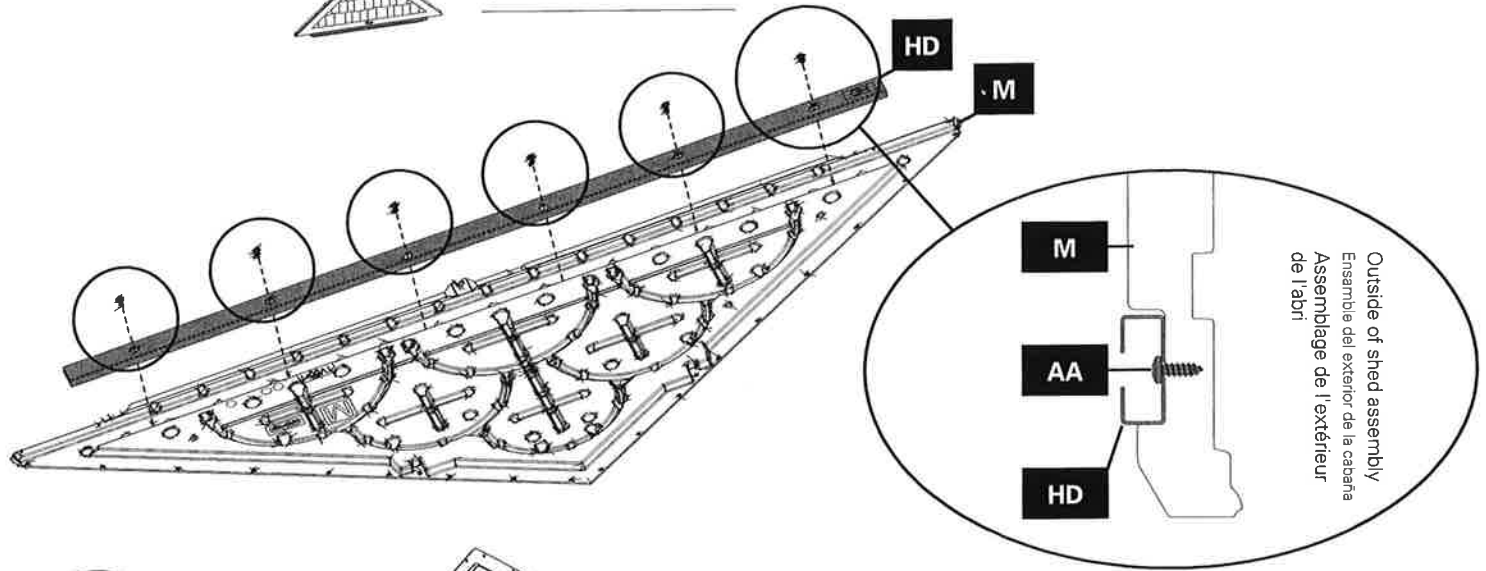

16b



16c

AA 2/2

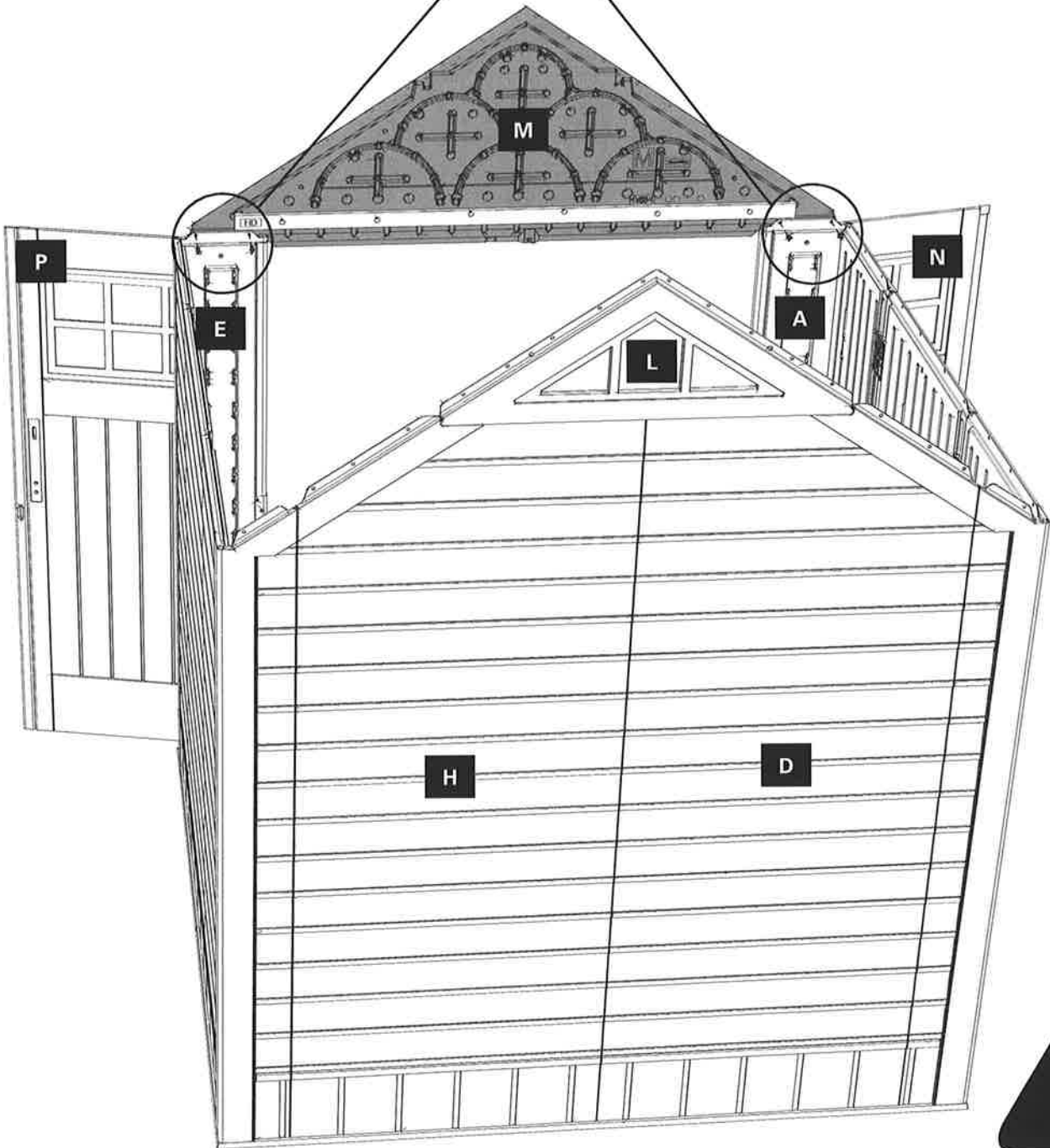
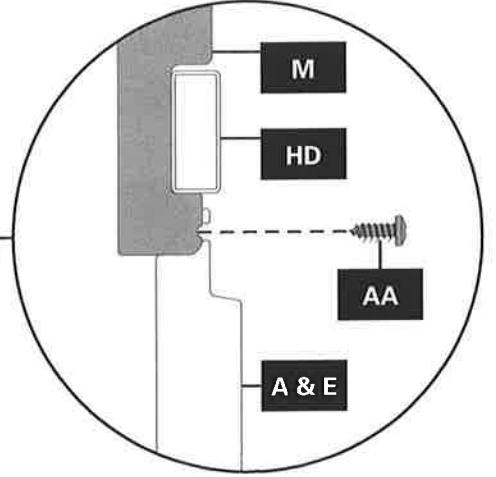
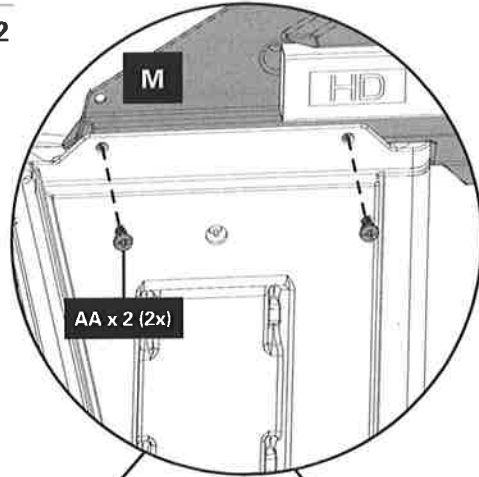

17a

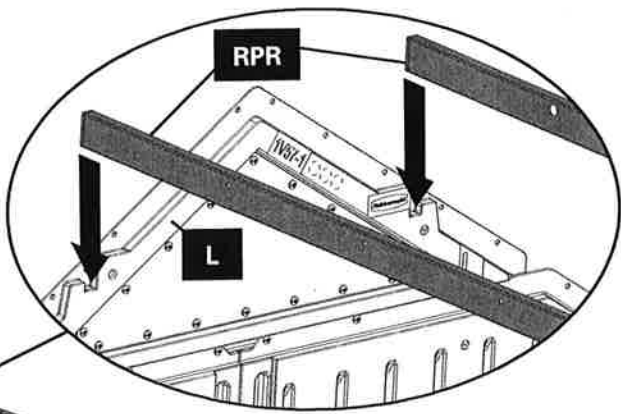
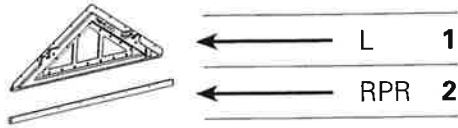

Front and back installation are the same.

La instalación del frente y de la parte trasera son iguales.

Les installations avant et arrièresont les mêmes.

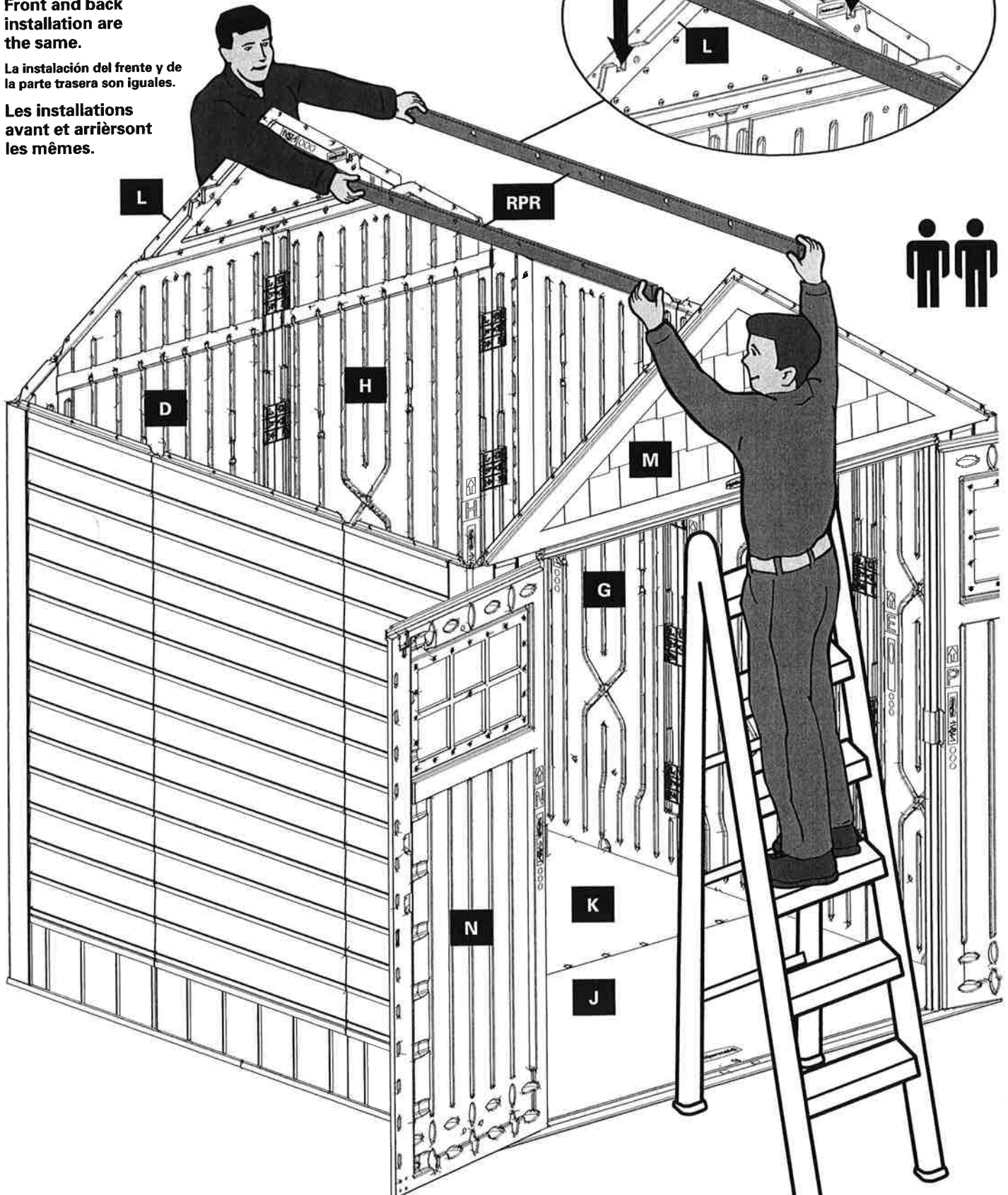





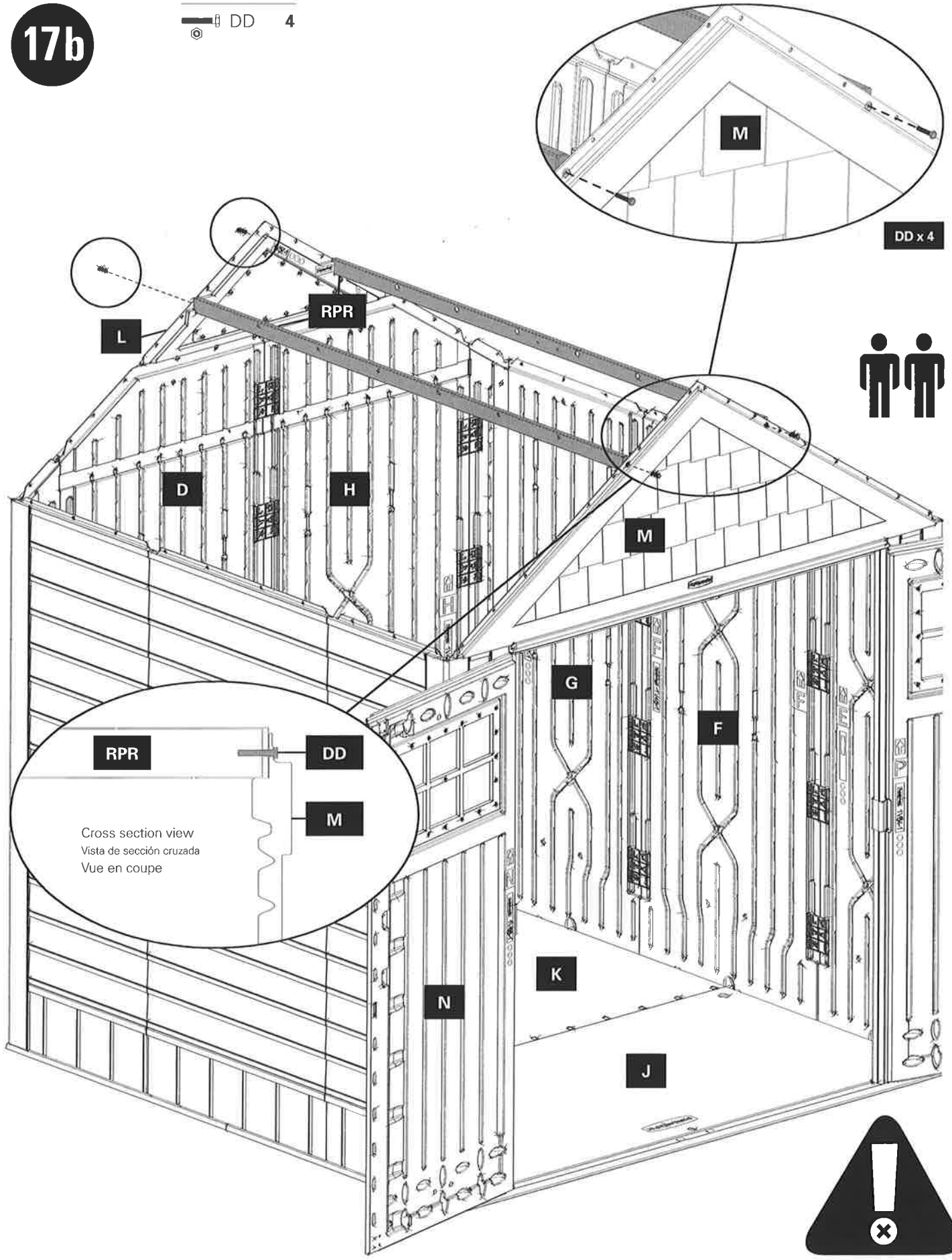

17b

DD 4



**18a**

	DD	2
	EE	2
	CT	1
	CTB	4
	GG	2

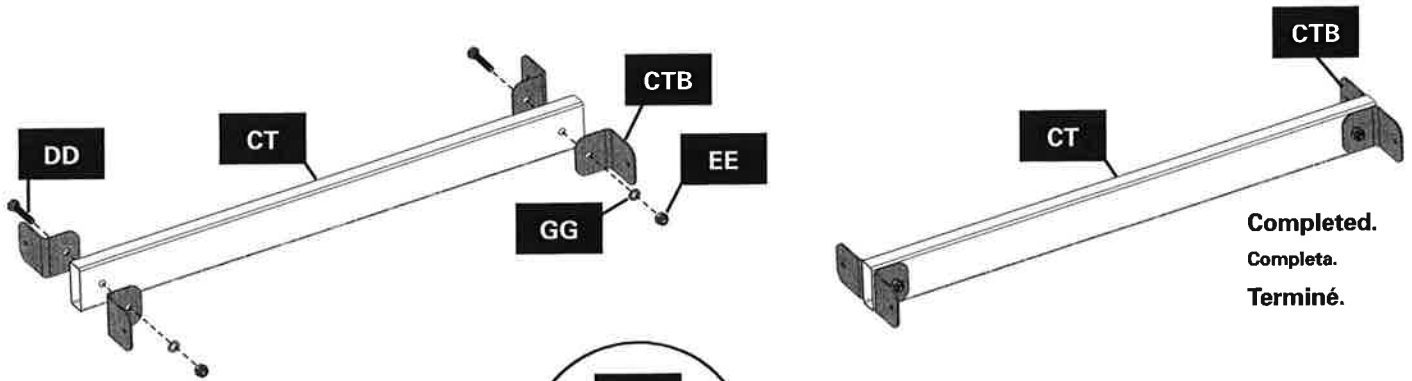

**18b**

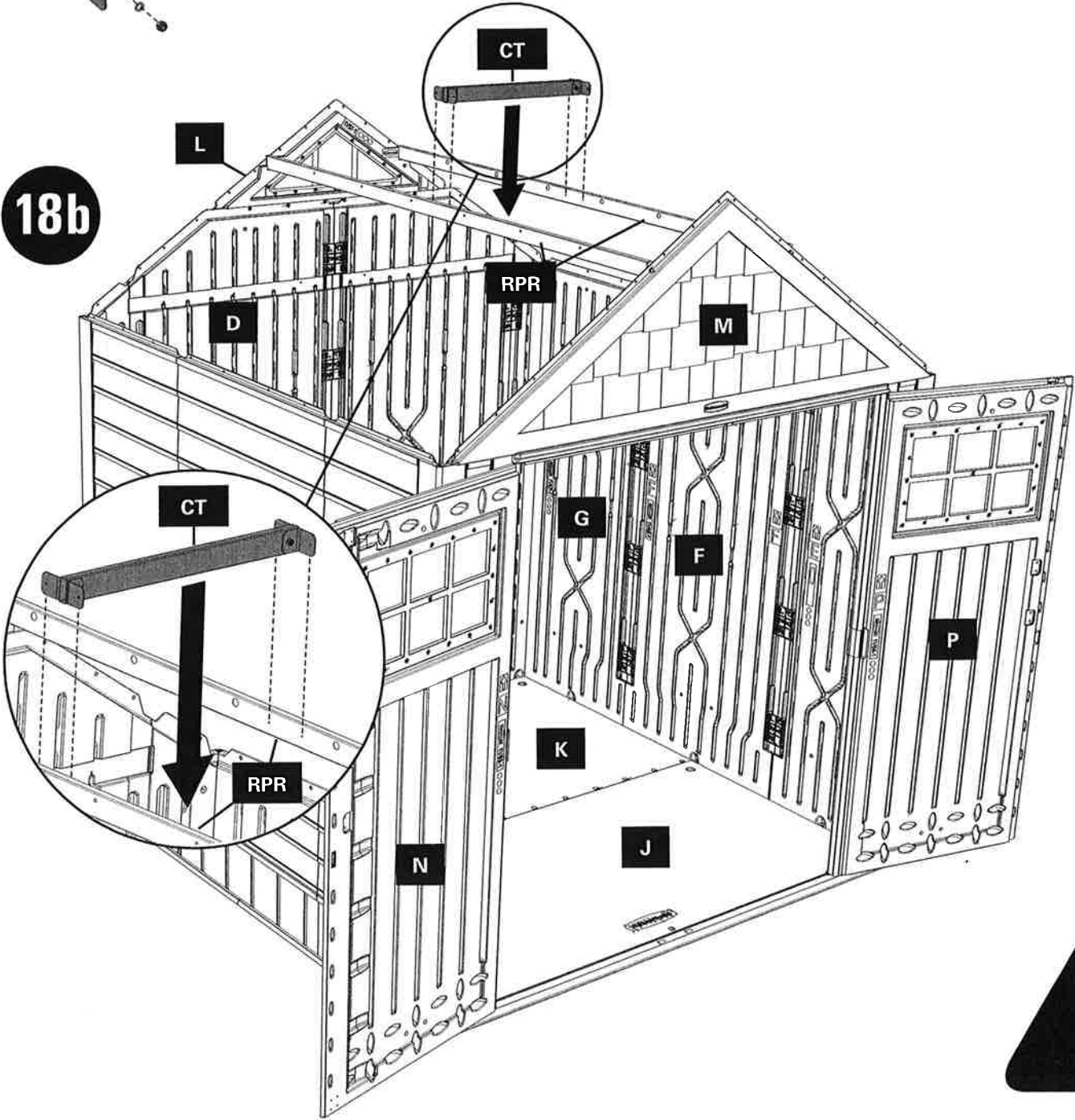



18c

© FF 4

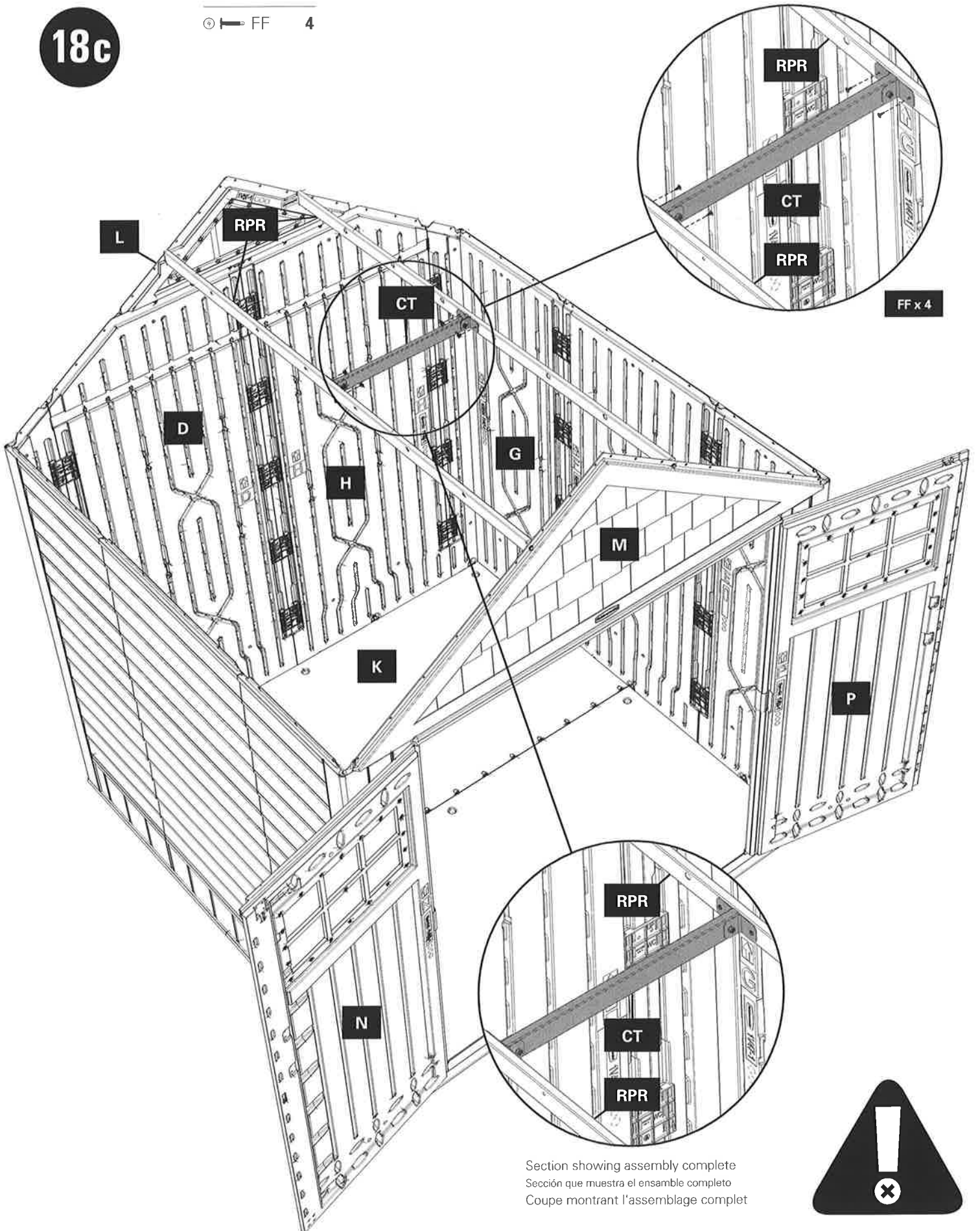

Section showing assembly complete  
Sección que muestra el ensamble completo  
Coupe montrant l'assemblage complet



19a

HD 1

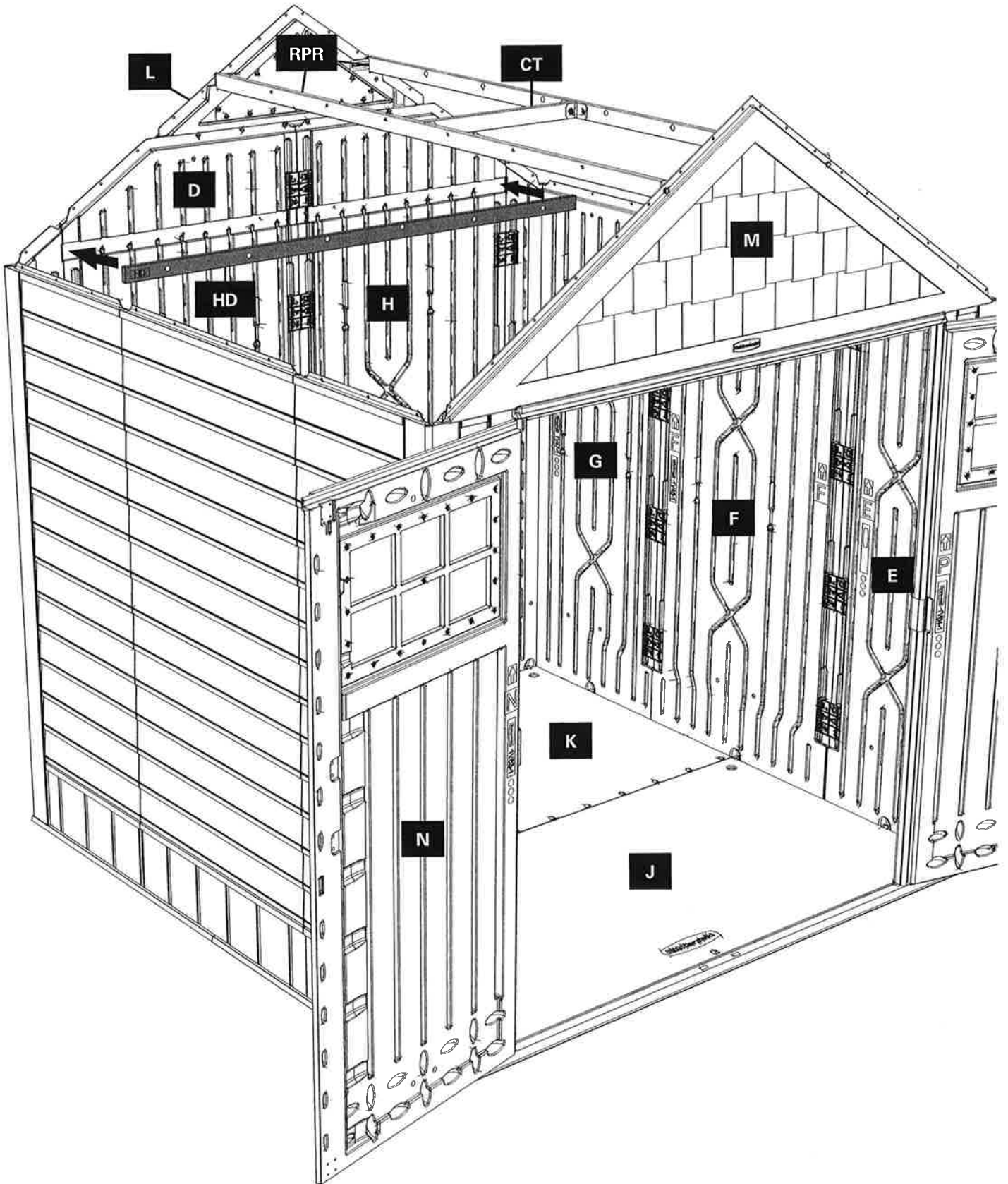

# 19b

AA 6

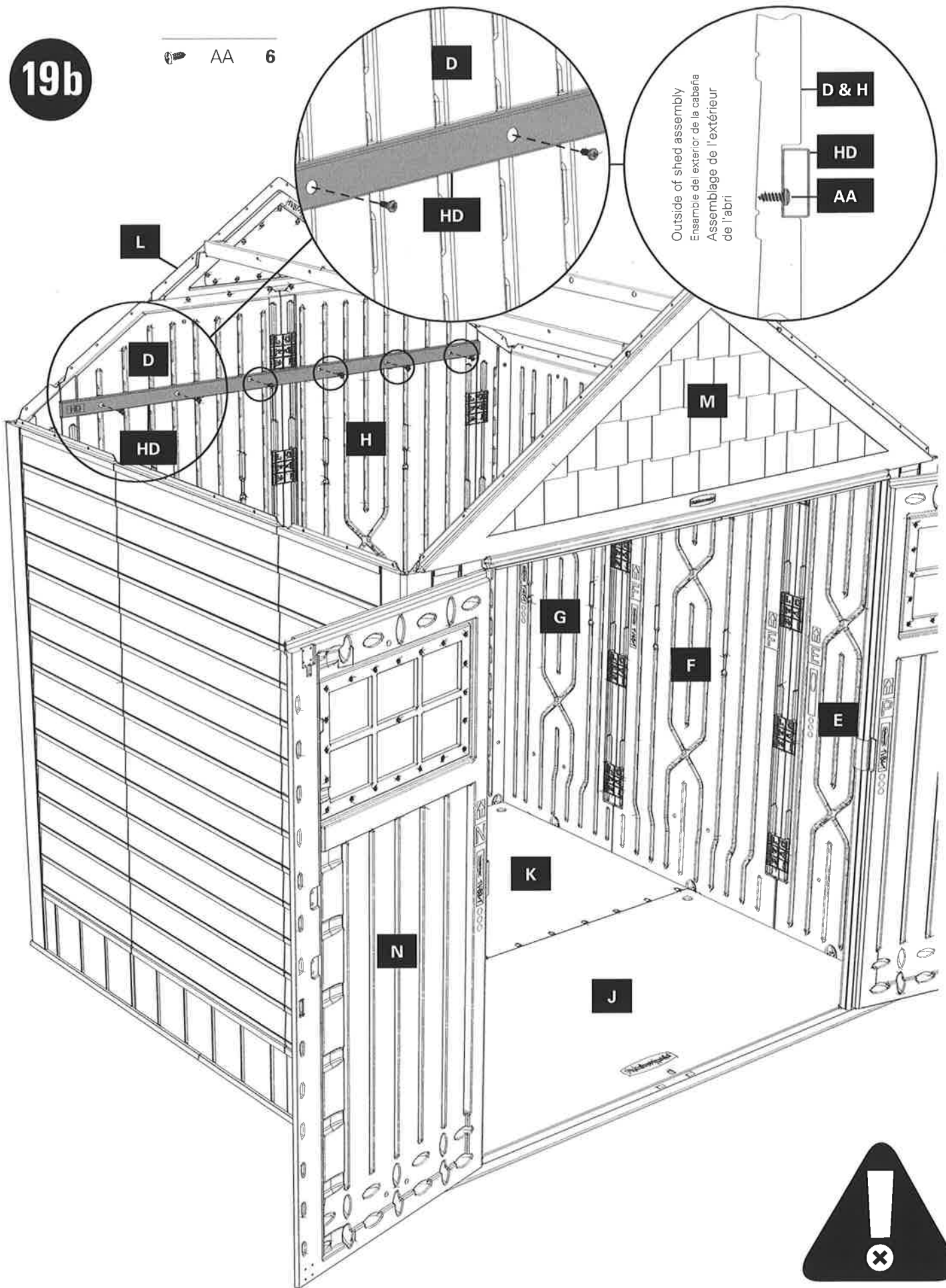

20a



Q 1

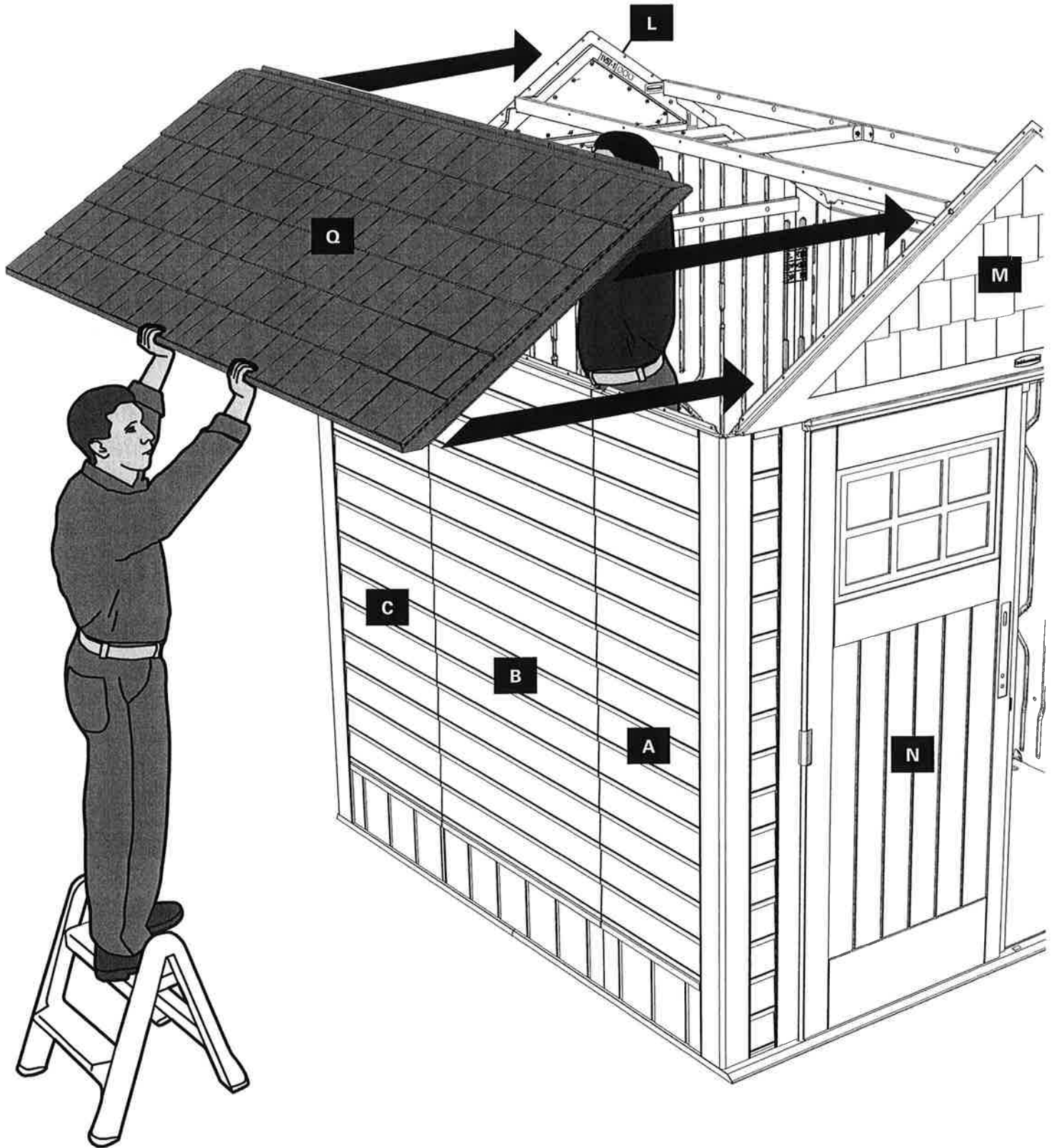



20b

AA 6

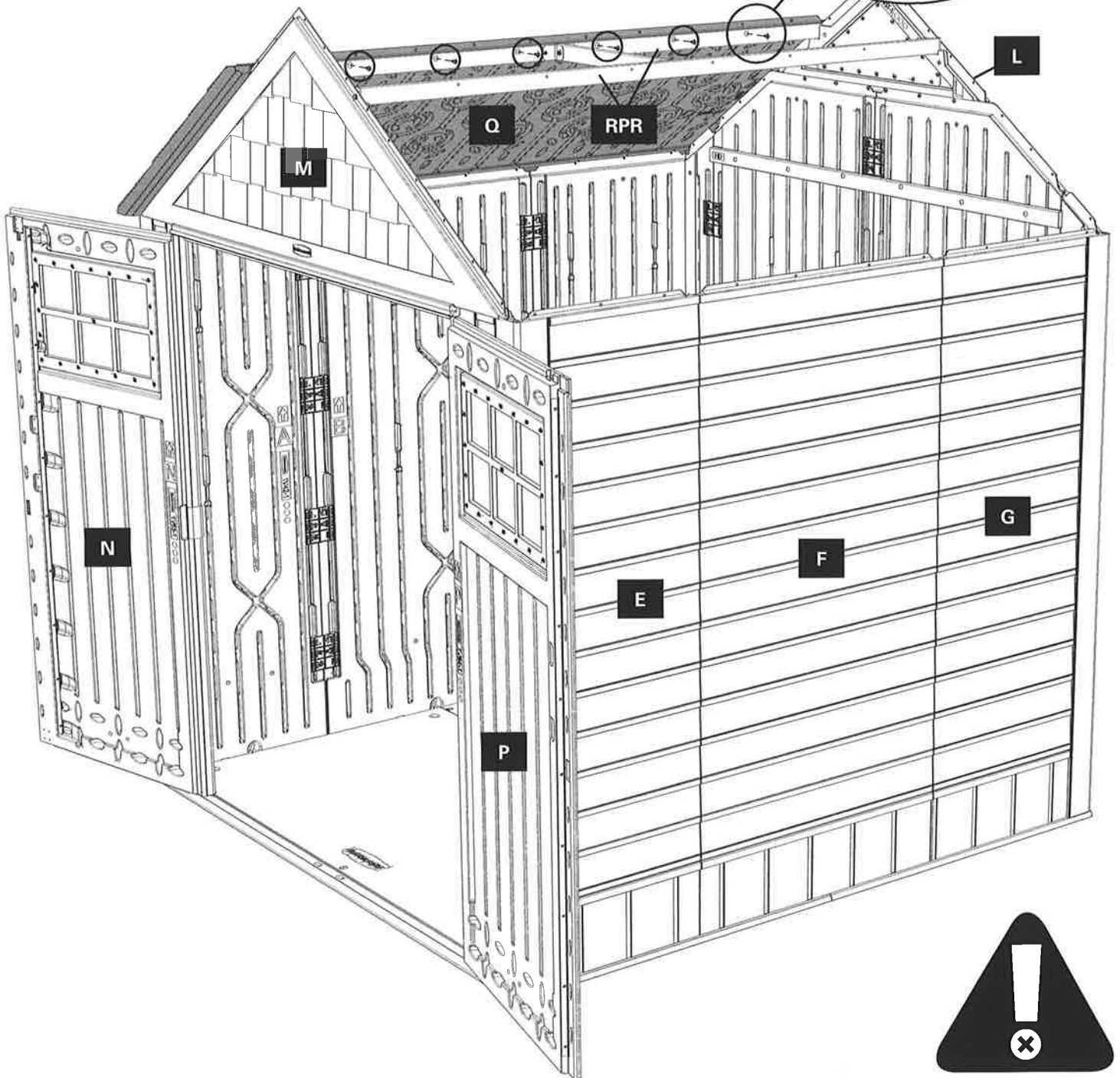
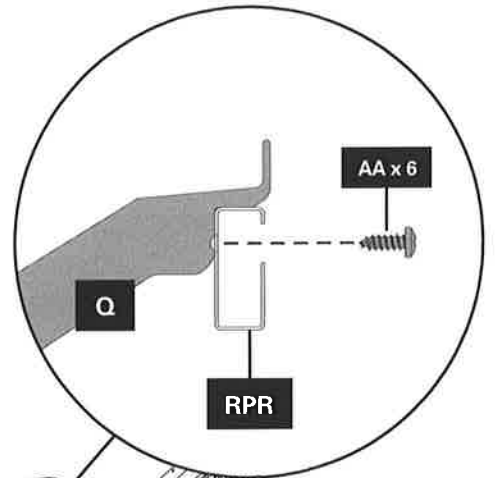

20c



Q 1

AA 6

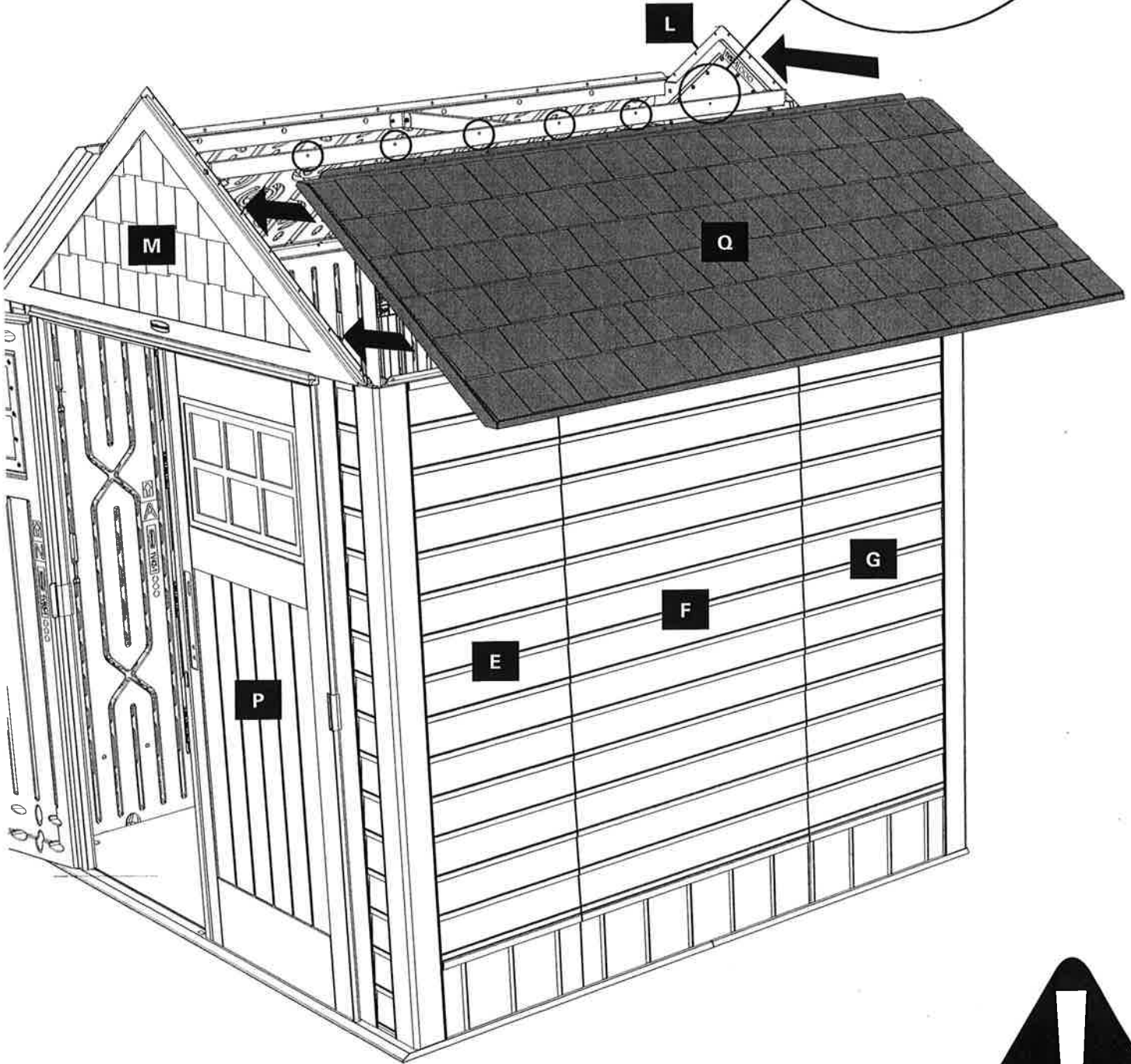
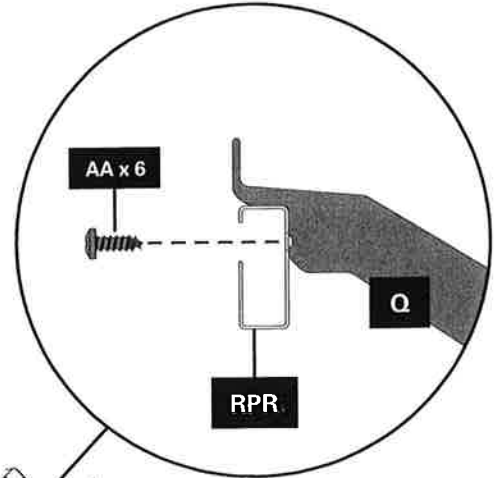

21a

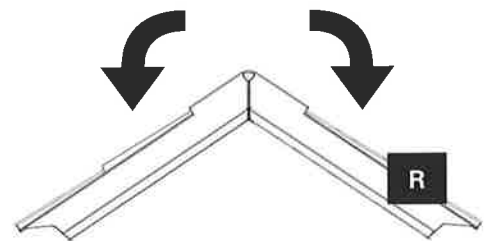
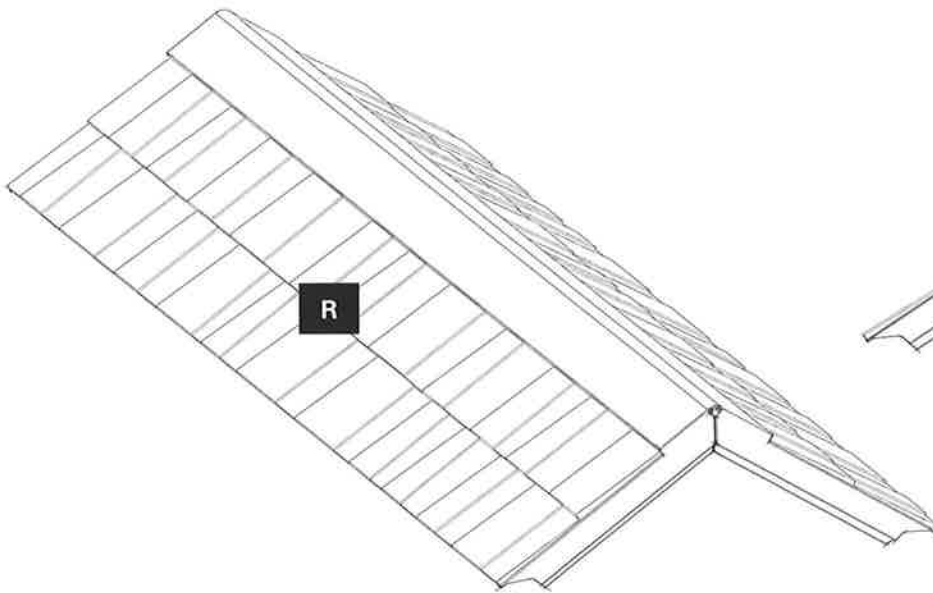
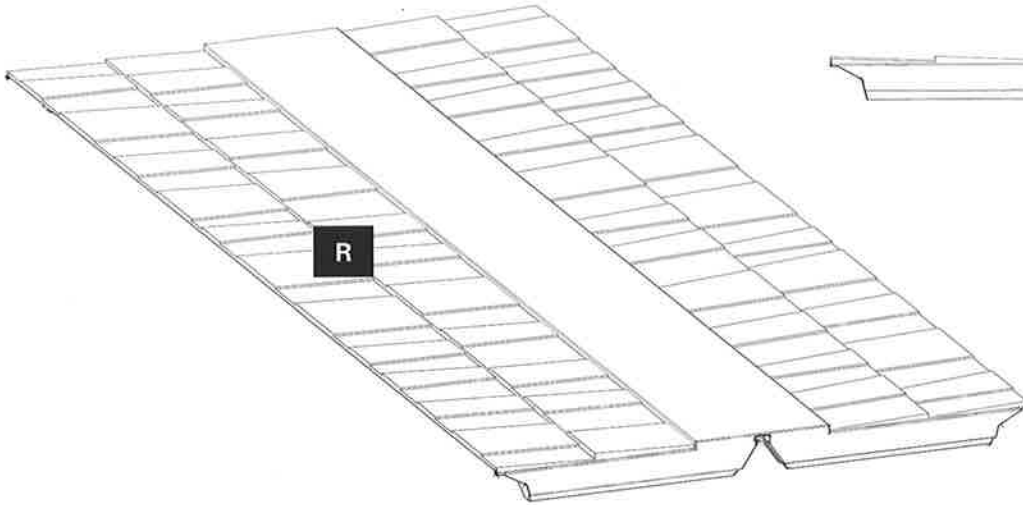

21b

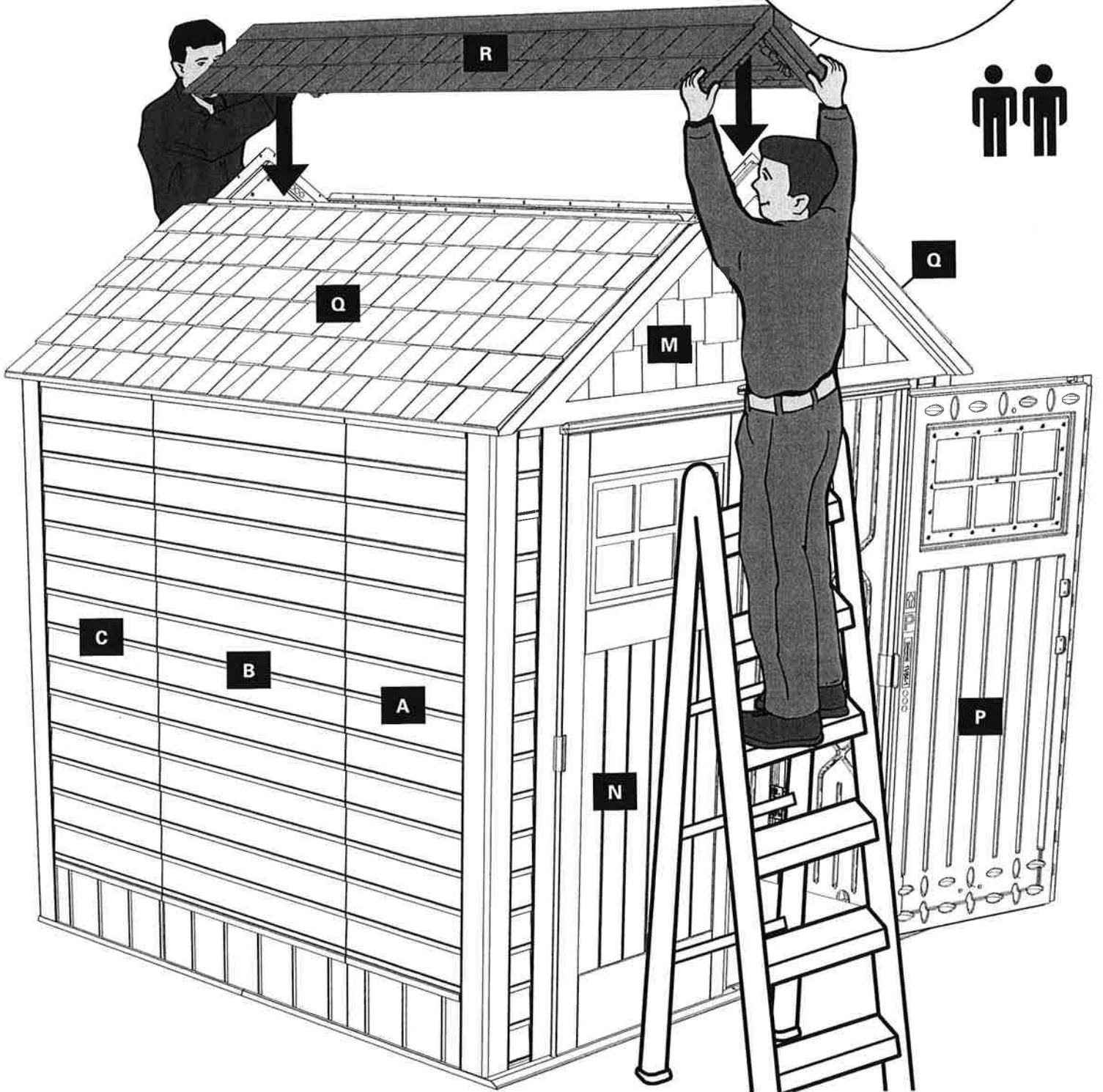
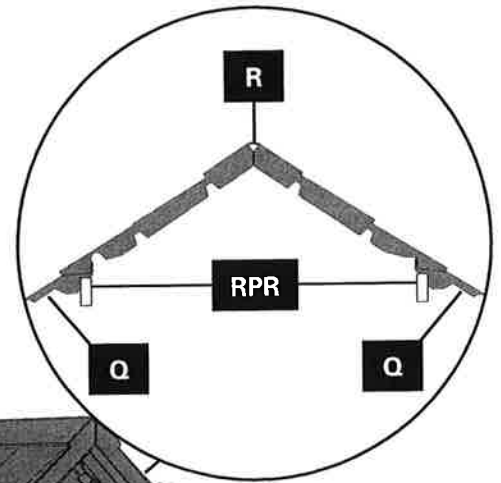



21c

① FF 4 per side / 4 por lado / 4 de chaque côté

RPN 4 per side / 4 por lado / 4 de chaque côté

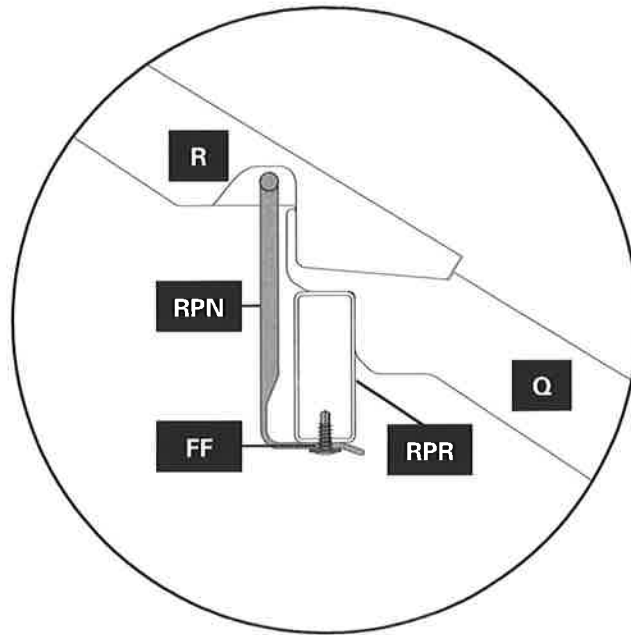
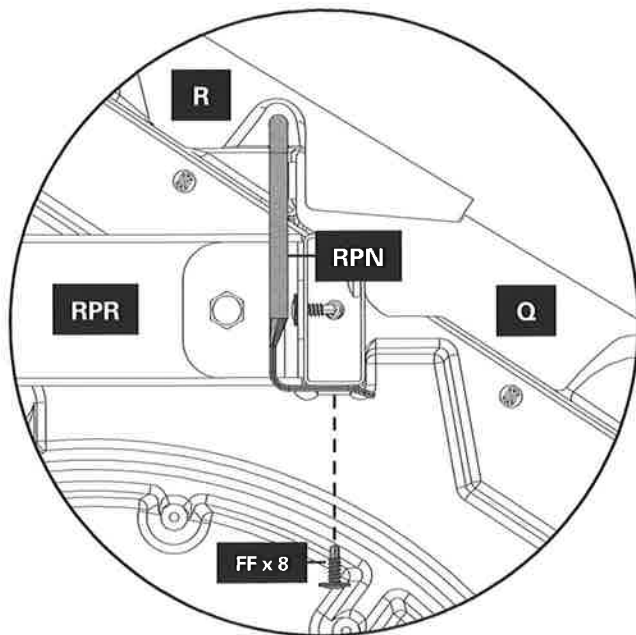
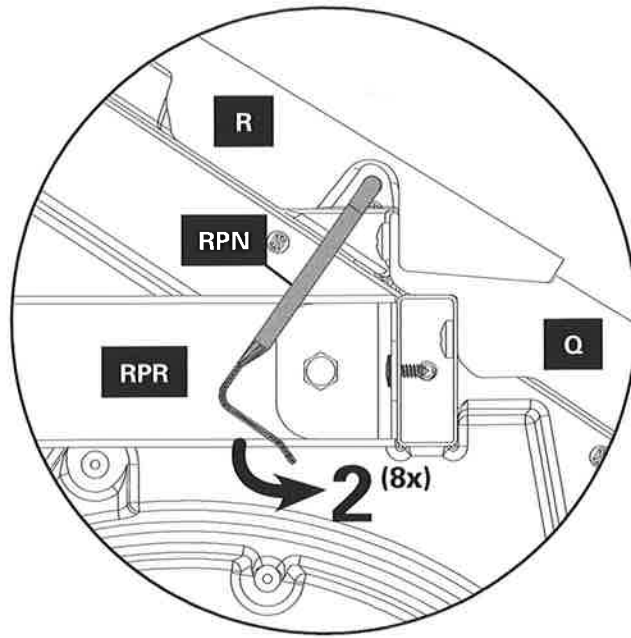
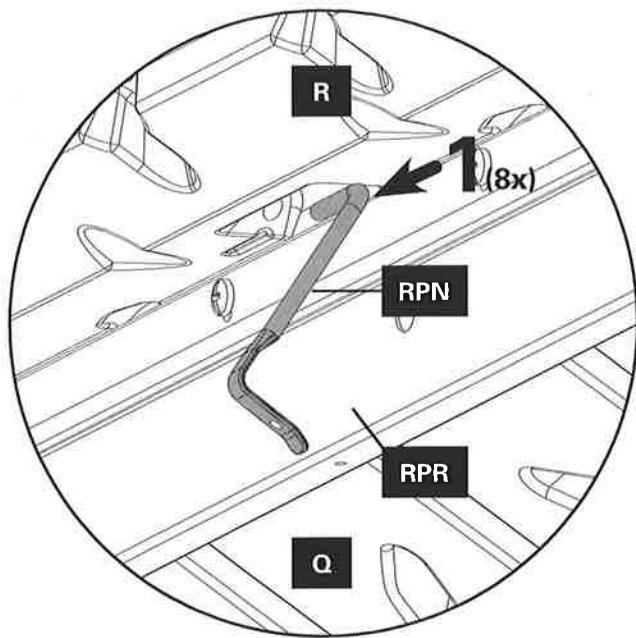

RPN in place (repeat 8x)  
RPN en posición (repetir 8 veces)  
RPN en place (répéter 8x)

RPN installation complete  
Instalación completa de RPN  
L'installation RPN est terminée



# 21d

AA 10/10

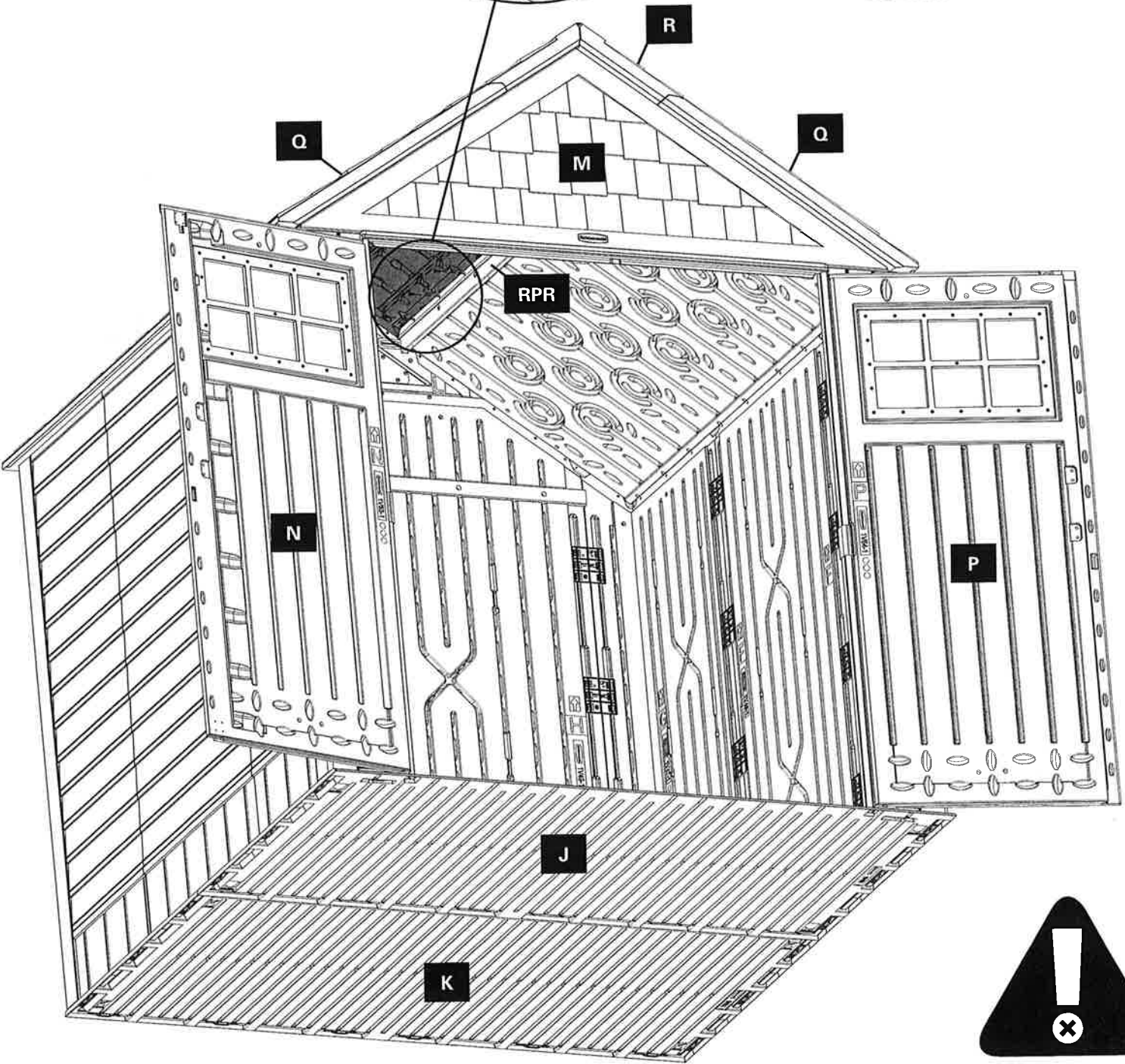
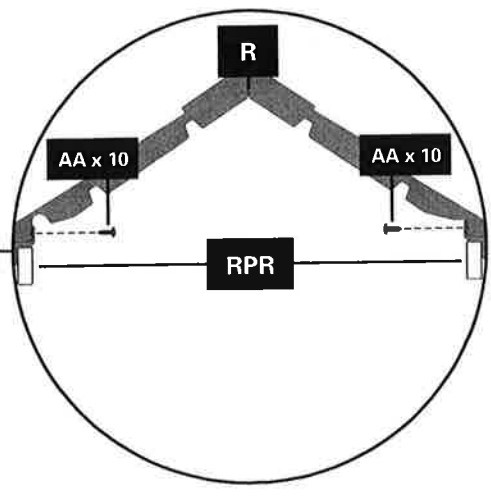
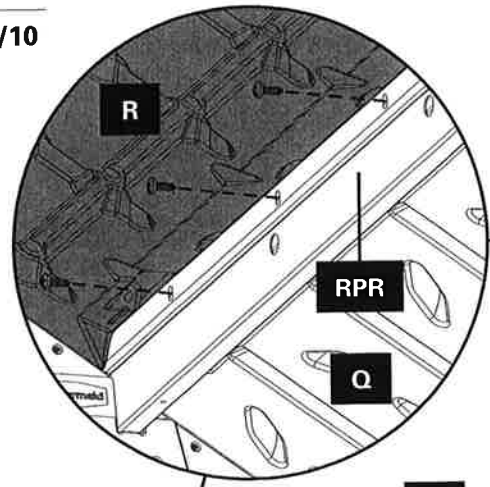

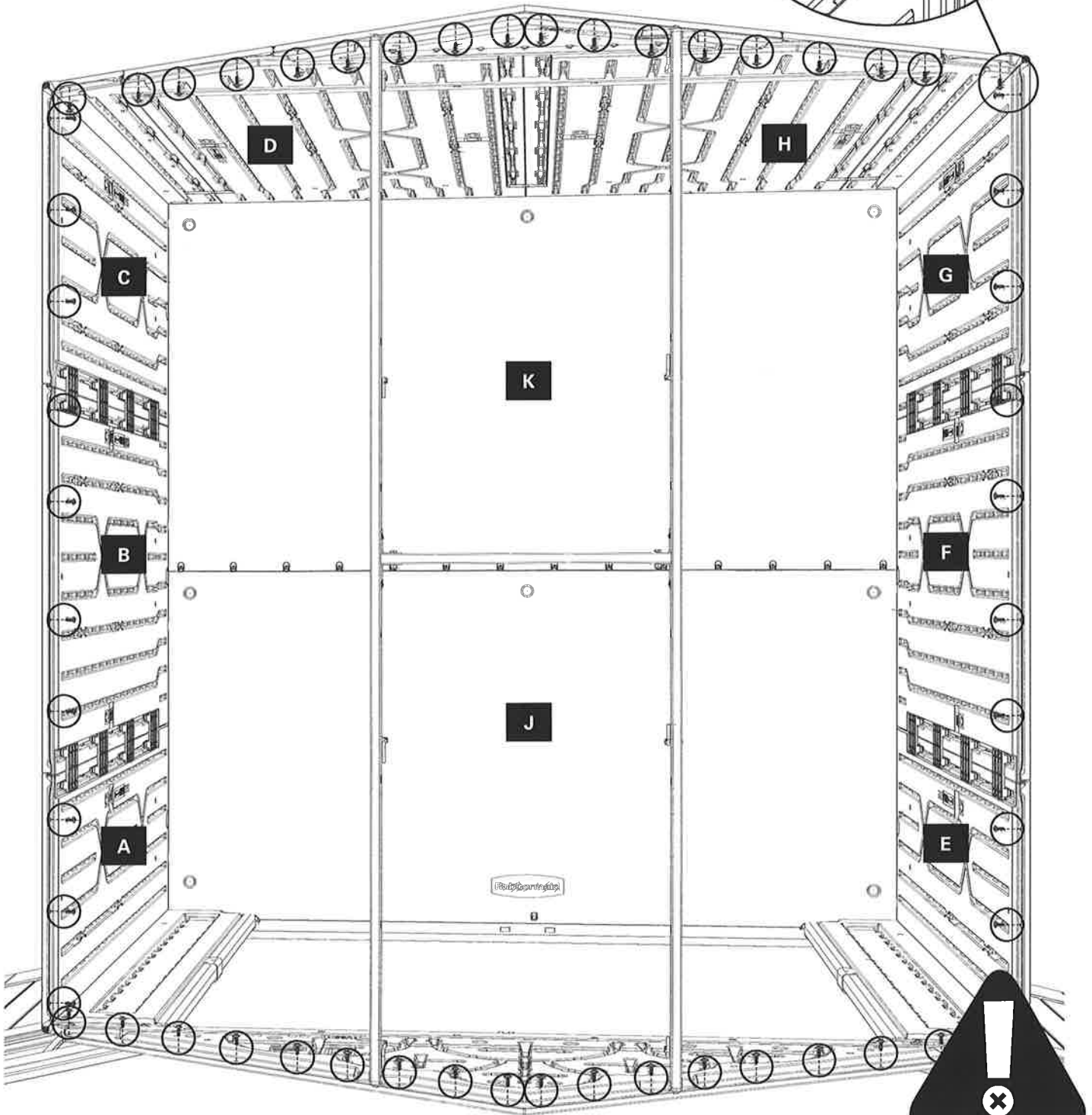
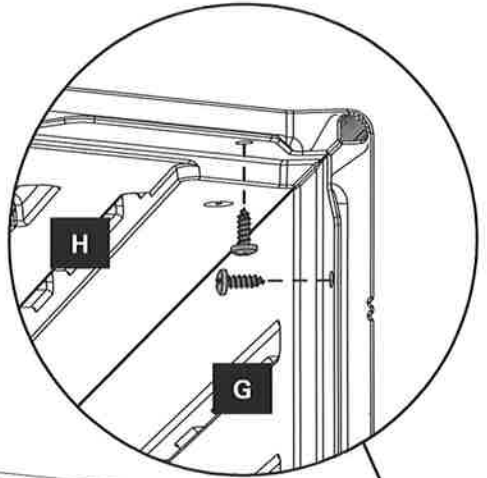

Continued.

Continúa.

Suite.

Additional images.

Imágenes adicionales.

Images supplémentaires.

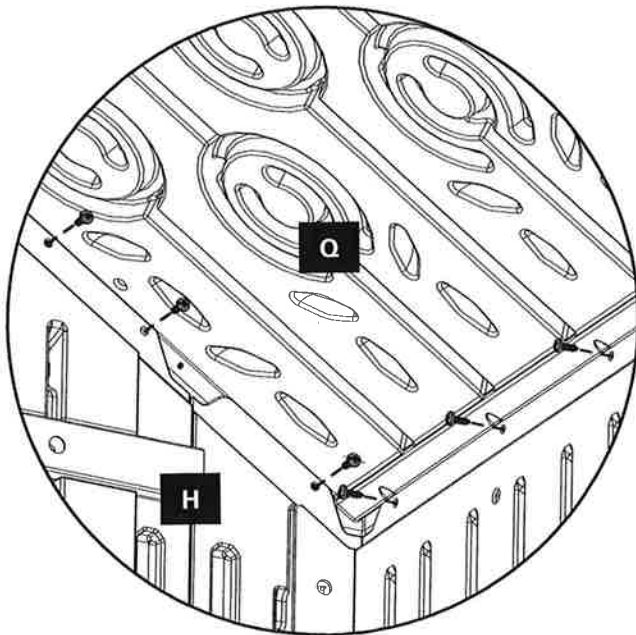
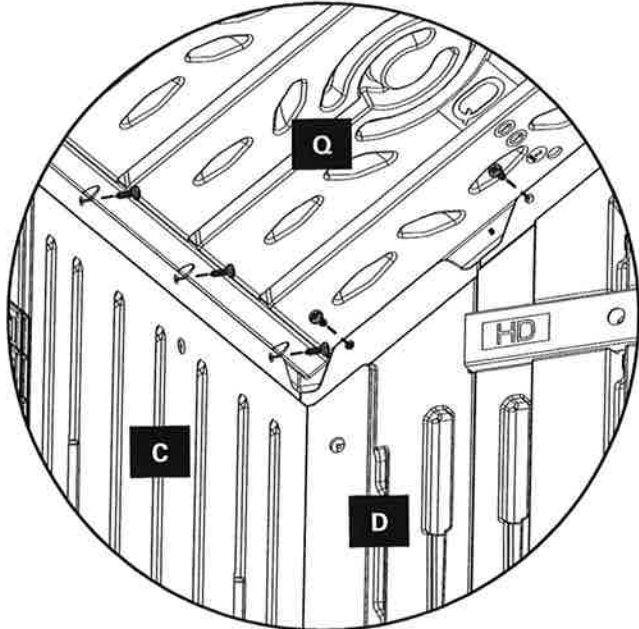

Additional section images.

Imágenes de sección adicionales.

Images de coupes supplémentaires.

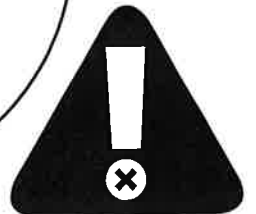
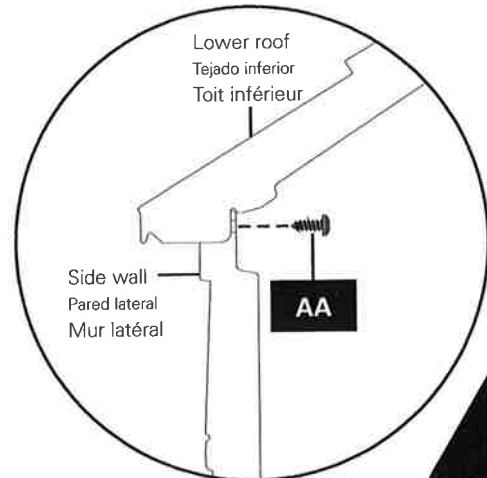
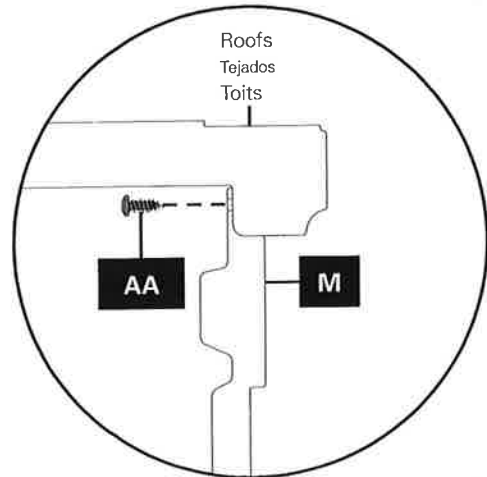
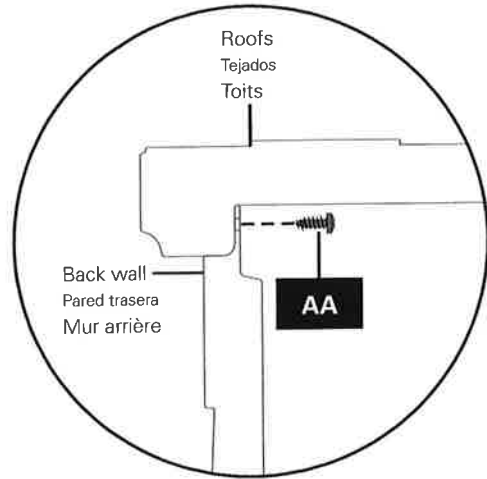

# 23a

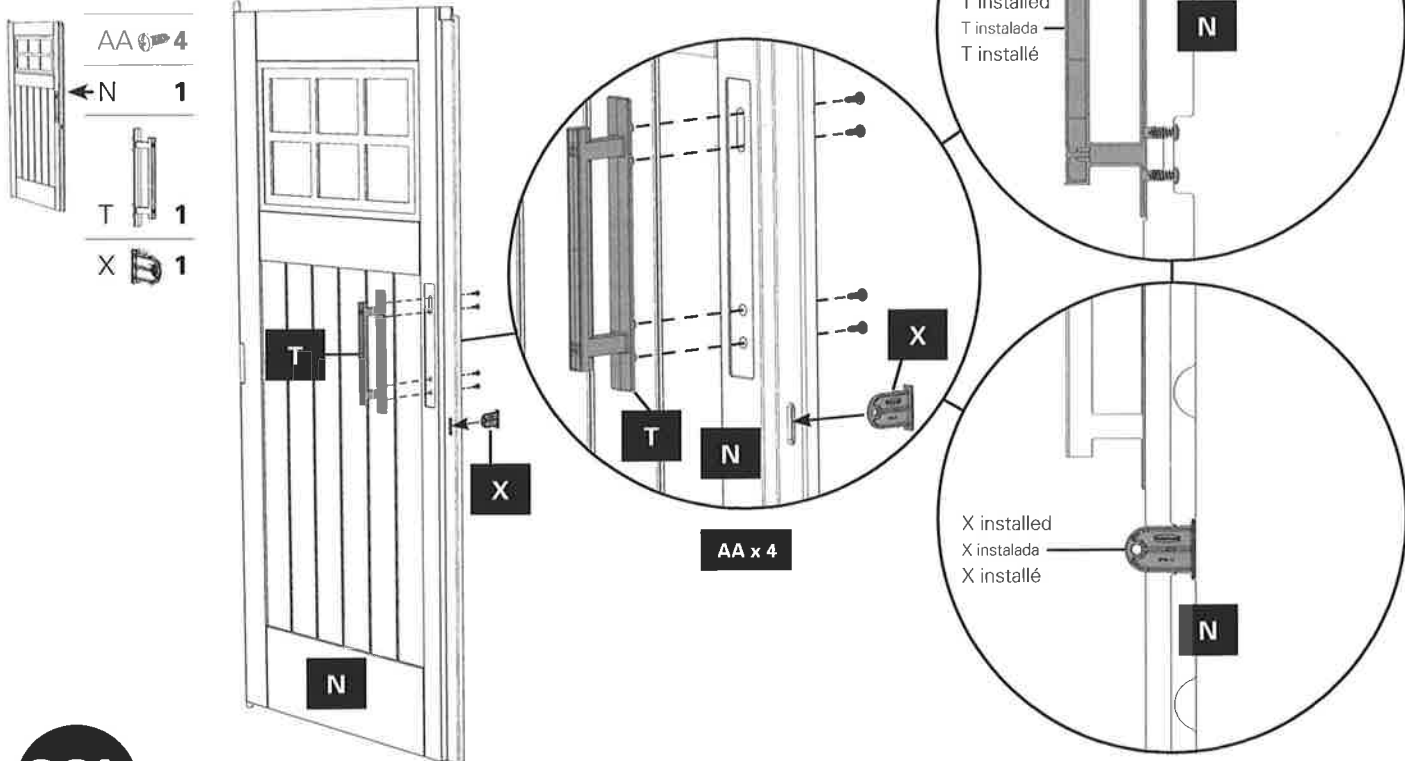

# 23b

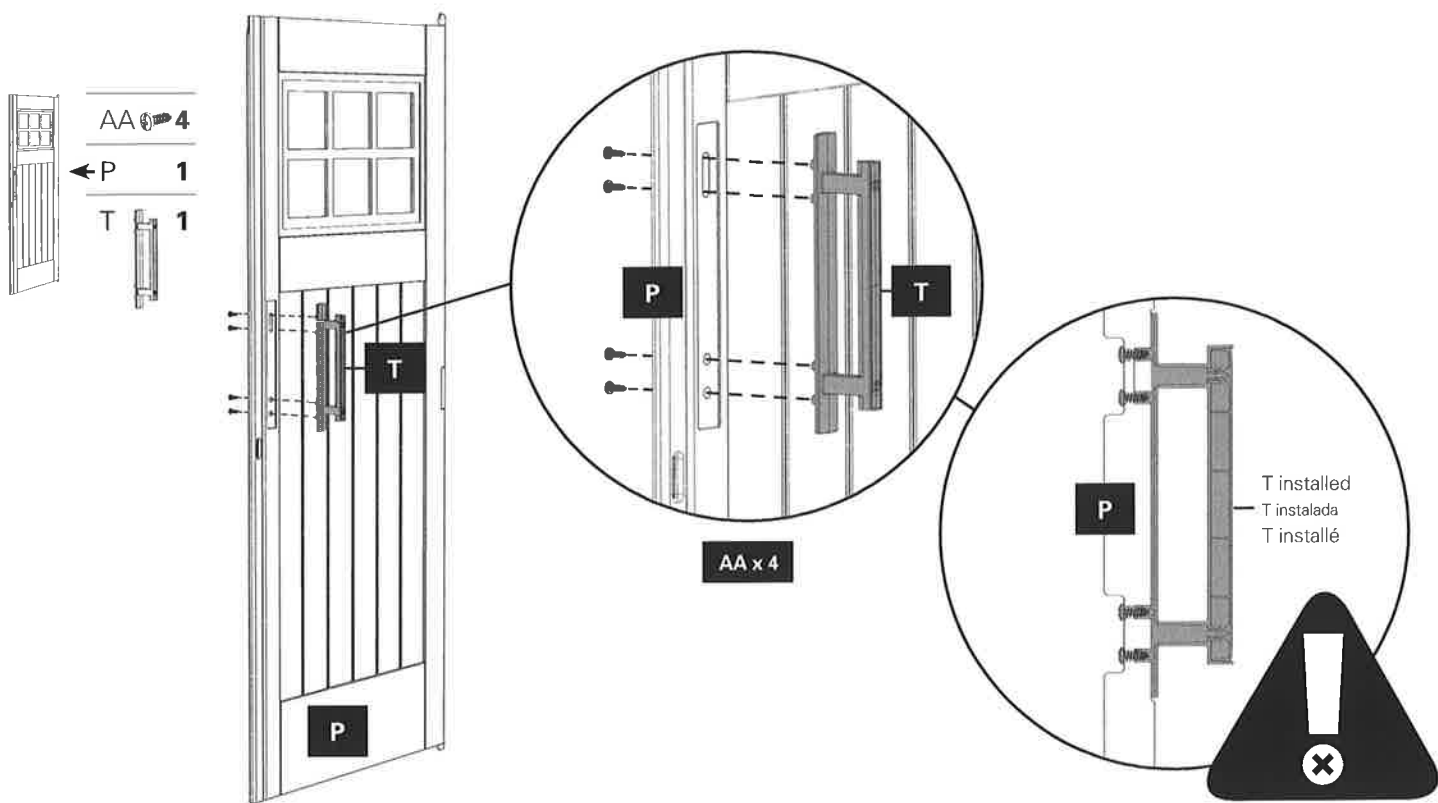

24

AA 12

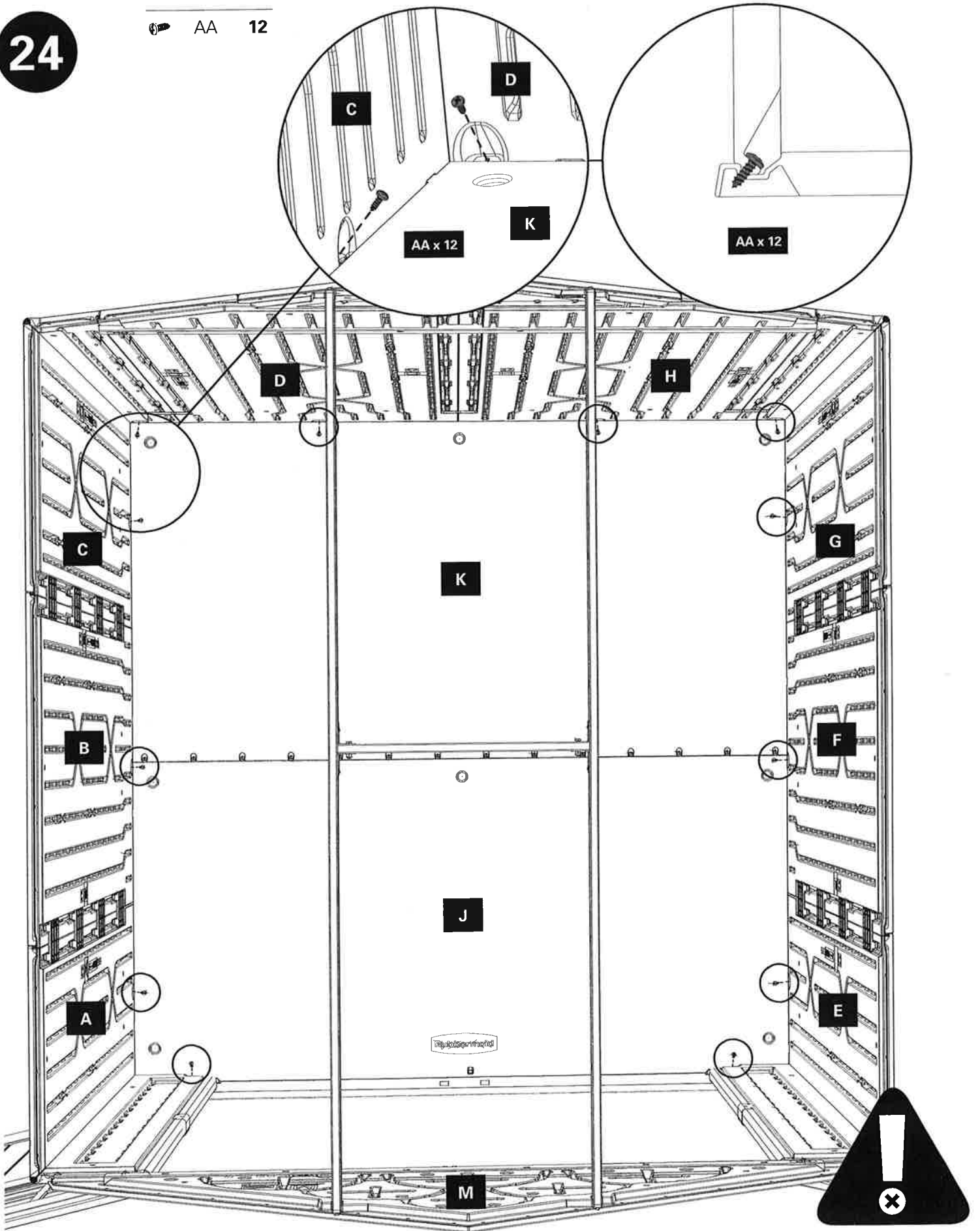

## Maintenance & Safety

- Periodically check storage building to ensure it remains stable and the site remains level.
- In areas of extreme high winds it is recommended to anchor storage building to platform or ground by drilling holes in the floor at designated location and secure with the proper fasteners (not included).
- Wash storage building with a garden hose or a mild detergent. Do not use abrasive detergents, materials or cleaning tools.
- Hot items such as recently used grills or fire pits should not be stored in the building.
- Heavy items should not be leaned against the walls, as this may cause distortion.
- Keep doors closed and secured when not in use to prevent wind damage.
- To maximize your product's performance, remove excessive snow and debris accumulation from the roof.
- Do not climb onto roof.
- Storage building is not designed for habitation.

## Mantenimiento y seguridad

- Periódicamente revise el cobertizo para asegurarse de que permanece estable y el sitio sigue estando nivelado.
- En áreas de fuertes vientos se recomienda anclar el cobertizo a una plataforma o al suelo, haciendo perforaciones en el piso en lugares indicados y asegurarlo con los bulones apropiados (no incluidos).
- Limpie el cobertizo con una manguera de jardín o un detergente suave. No utilice detergentes, materiales o herramientas de limpieza abrasivas.
- No debe almacenar en el cobertizo elementos calientes como braseros o parrillas recién usados.
- No deben apoyarse elementos pesados en las paredes, ya que esto podría provocar deformación.
- Mantenga las puertas cerradas y sujetas cuando no use el producto para prevenir daños.
- Para maximizar su desempeño del producto, quite el exceso de nieve o la acumulación de escombros del techo.
- No debe treparse al techo.
- El cobertizo no está diseñado para ser habitado.

## Entretien et sécurité

- Il est recommandé de vérifier l'abri de temps en temps pour vous assurer qu'il demeure stable et que le site reste à niveau.
- Dans les zones de vents puissants, il est recommandé d'ancrer l'abri à une plateforme ou au sol, en perçant des trous dans le plancher aux endroits désignés et de l'fixer avec des attaches appropriées (non fournies).
- Il est recommandé de laver l'abri de rangement avec un tuyau d'arrosage ou un détergent doux. Ne pas utiliser de détergents abrasifs, du matériel ou des outils de nettoyage.
- Les objets chauds comme les barbecues venant d'être utilisés ou les foyers ne doivent pas être rangés dans la remise.
- Les objets lourds ne doivent pas être appuyés contre un mur, car ils risqueraient de causer une déformation.
- Lorsque la remise n'est pas utilisée, gardez les portes fermées et verrouillées pour éviter tout dommage.
- Afin de prolonger la durée de vie de l'article, enlevez la neige et les débris qui s'accumulent sur le toit.
- Ne grimpez pas sur le toit.
- L'abri de rangement n'est pas conçu pour l'habitation.





visit [www.rubbermaid.com/outdoorliving](http://www.rubbermaid.com/outdoorliving) for helpful tips and information

---

visite [www.rubbermaid.com/outdoorliving](http://www.rubbermaid.com/outdoorliving) para información y consejos útiles

---

Visitez [www.rubbermaid.com/outdoorliving](http://www.rubbermaid.com/outdoorliving) pour des conseils pratiques et de l'information



**YOU'RE DONE!** Remember, if you have any trouble, don't call or return to the store. Call our Consumer Service Department at 1-888-895-2110 (Mon.–Fri. 8:30 a.m. to 5:00 p.m. EST). Keep this instruction booklet and your original store receipt to ensure our Consumer Service Department can accurately and quickly assist you.

---

**¡YA ESTÁ!** Recuerde, si tiene problemas, no llame a la tienda ni devuelva el producto. Llame a nuestro Departamento de Atención al Cliente al 1-888-895-2110 (de lunes a viernes, de 8:30 a. m. a 5:00 p. m. EST). Guarde este manual de instrucciones y la factura original de su tienda para garantizar que nuestro Departamento de Atención al Cliente pueda ayudarlo rápida y correctamente.

---

**TERMINÉ!** Rappel : si vous avez des difficultés, appelez au magasin ou retournez l'article. Appelez notre service aux consommateurs au 1-888-895-2110 (lun. au ven. de 8 h 30 à 17 h HNE). Veuillez garder le présent livret d'instructions et le reçu du magasin afin que notre service aux consommateurs puisse vous aider adéquatement.