

NINJA™

Master Prep™ *Professional*

OWNER'S GUIDE

QB1000 30

QB1000CO 30

QB1002 30

QB1003 30



IMPORTANT SAFETY INSTRUCTIONS

SAVE THESE INSTRUCTIONS

For Household Use Only

WHEN USING ELECTRICAL APPLIANCES, BASIC SAFETY PRECAUTIONS SHOULD ALWAYS BE FOLLOWED, INCLUDING THE FOLLOWING:

READ ALL INSTRUCTIONS BEFORE USING YOUR NINJA™ MASTER PREP™ PROFESSIONAL.

POLARIZED PLUG

WARNING: To reduce the risk of electric shock, this appliance has a polarized plug (one blade is wider than the other). This plug will fit into a polarized outlet only one way. If the plug does not fit fully into the outlet, reverse the plug. If it still does not fit, contact a qualified electrician to install the proper outlet. **DO NOT modify the plug in any way.**

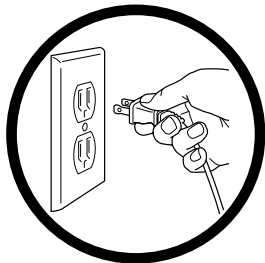

1. Close supervision is necessary when any appliance is used by or near children.
2. To protect against electric shock, **DO NOT** immerse cord, plug or any part of the main unit in water or any other liquids.
3. **DO NOT** let cord hang over edge of table or counter, or touch hot surfaces.
4. **DO NOT** operate any appliance with a damaged cord or plug, or after the appliance malfunctions, has been dropped or damaged in any manner. Return the appliance to EURO-PRO Operating LLC for examination, repair or adjustment.
5. Unplug appliance from outlet when not in use and before cleaning.
6. **DO NOT** place on or near a hot gas or electric burner.
7. The use of accessory attachments, including canning jars not recommended by EURO-PRO Operating LLC may cause fire, electrical shock or risk of personal injury.
8. Extreme caution must be used when moving an appliance containing hot food, water or other liquids.
9. Use this appliance on a stable work surface away from water.
10. **DO NOT** remove the motor head before the chopping blades have stopped turning.
11. **CAUTION!** Chopping blades are sharp, handle with care. When handling the chopping blades, always hold by the plastic shaft.
12. **DO NOT attempt to sharpen blades.**
13. **DO NOT** expose jars to extreme temperature changes.
14. **DO NOT** use jars if they are cracked or chipped.
15. **DO NOT** use the appliance if chopping blades are bent or damaged.
16. Avoid contact with moving parts at all times. Keep hands, hair, clothing as well as spatulas and other utensils away from pitcher or chopping container during operation to prevent risk of personal injury and/or damage to the appliance.
17. Exercise extreme caution when blending hot liquids.
18. Immediately release the On/Off pulse button on the motor head in the event that the appliance malfunctions during use.
19. To reduce the risk of injury, **NEVER** operate the appliance without the splash guard in place; **DO NOT** try to defeat the interlock mechanism; make sure that the cutting blades are properly assembled before operating the appliance.
20. **DO NOT** use outdoors.
21. **DO NOT** use appliance for other than intended use.
22. **DO NOT** operate the appliance for more than 15 seconds.
23. **DO NOT** operate the appliance empty.
24. If the appliance overheats, a thermal switch will become activated and shut off the motor. To reset, unplug the appliance and let it cool down for approximately 10 minutes before using again.

NOTE: This unit has a short power supply cord to reduce the risk resulting from becoming entangled in or tripping over a long cord. An extension cord may be used if you are careful in its use:

1. The electrical rating of the extension cord should be at least as great as the electrical rating of the appliance.
2. An extension cord with the power cord must be arranged so that it will not drape over the countertop or tabletop where they can be pulled on by children or tripped over accidentally.

Thank you for
purchasing
the Ninja™
Master Prep™
Professional.

Getting Started	6
Using the Master Prep™ <i>Professional</i> Pitcher	8
Using the Master Prep™ <i>Professional</i> Bowl	10
Cleaning and Maintenance	12
Troubleshooting Guide	12
Warranty	13
Registration	15

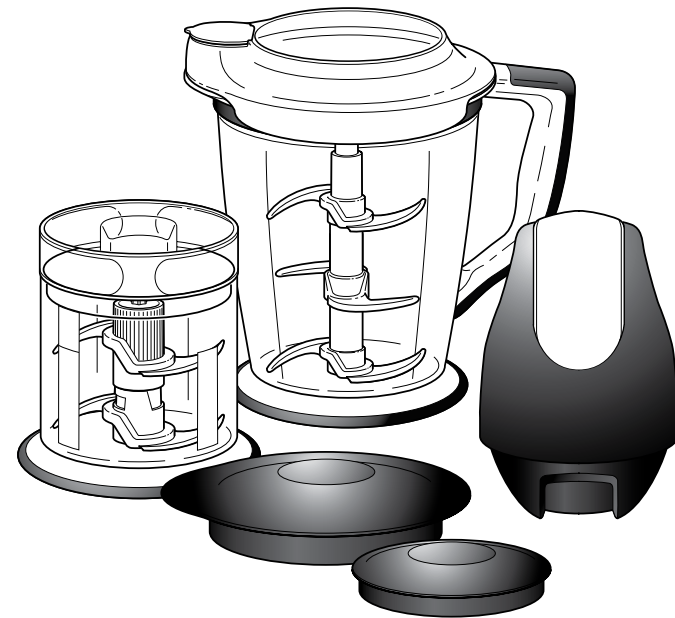

TECHNICAL SPECIFICATIONS

Voltage: 120V., 60Hz.

Power: 450 Watts

Pitcher Capacity: 1.42 L (48 ounces) (6 cups)

Bowl Capacity: 0.47 L (16 ounces) (2 cups)

Getting Started

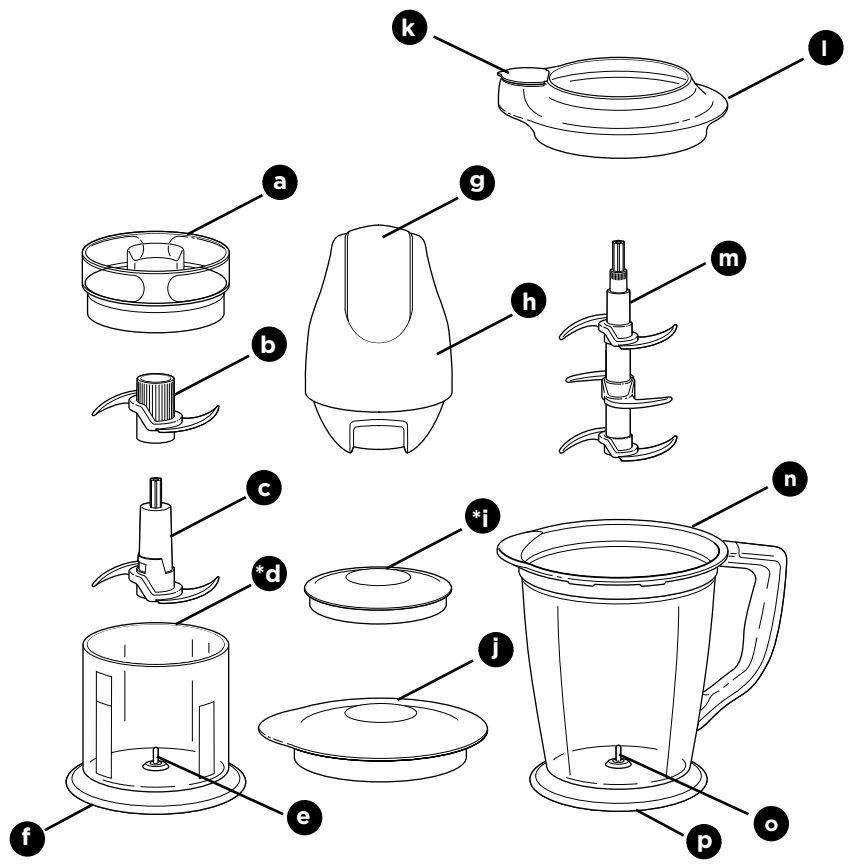

- a Bowl Splash Guard
- b Upper Blade (bowl)
- c Lower Blade (bowl)
- d* Master Prep... Professional Bowl
- e Spindle Pin
- f Non-Slip Base Gasket (bowl)
- g On/Off Pulse Button
- h Power Head

- i* Bowl Storage Lid
- j Pitcher Storage Lid
- k Pouring Spout
- l Pitcher Splash Guard
- m Ninja... 6-Blade
- n Master Prep... Professional Pitcher
- o Spindle Pin
- p Non-Slip Base Gasket (pitcher)
- q Power Cord (not shown)

***Note:**

- Models QB1000CO 30 and QB1002 30 come with 2 Master Prep... Professional Bowls (*d) and 2 Bowl Storage Lids (*i).
- Model QB1003 30 comes with 3 Master Prep... Professional Bowls (*d) and 3 Bowl Storage Lids (*i).

The Ninja... Master Prep... Professional is an indispensable kitchen tool that is perfect for blending, chopping, mixing or pureeing when preparing your favorite recipes. For best results, be sure to carefully read all the instructions contained in the manual before using this appliance.

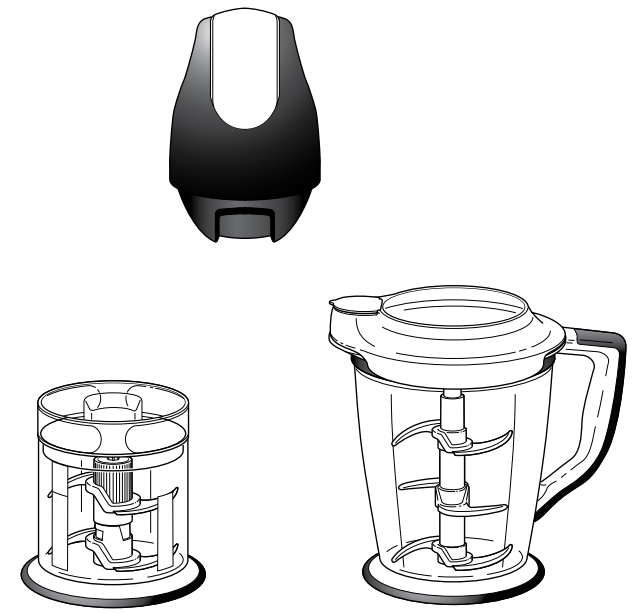

450 Watt Power Head

The 450 watt power head operates on 120V., 60Hz. electrical power. **NEVER** allow the power head to become wet when plugged into an electrical outlet.

- ▲ **WARNING:** The power head should never be immersed in water or any other liquid.
- ▲ **CAUTION:** Make sure that the power head is unplugged from the electrical outlet and that the blades have stopped turning before attaching or removing any accessory.
- ▲ **CAUTION: Blades are sharp! Use extreme caution when handling the blades. Always hold them by the shaft. Do not attempt to sharpen blades.**
- ▲ **IMPORTANT: Never run the appliance empty.**

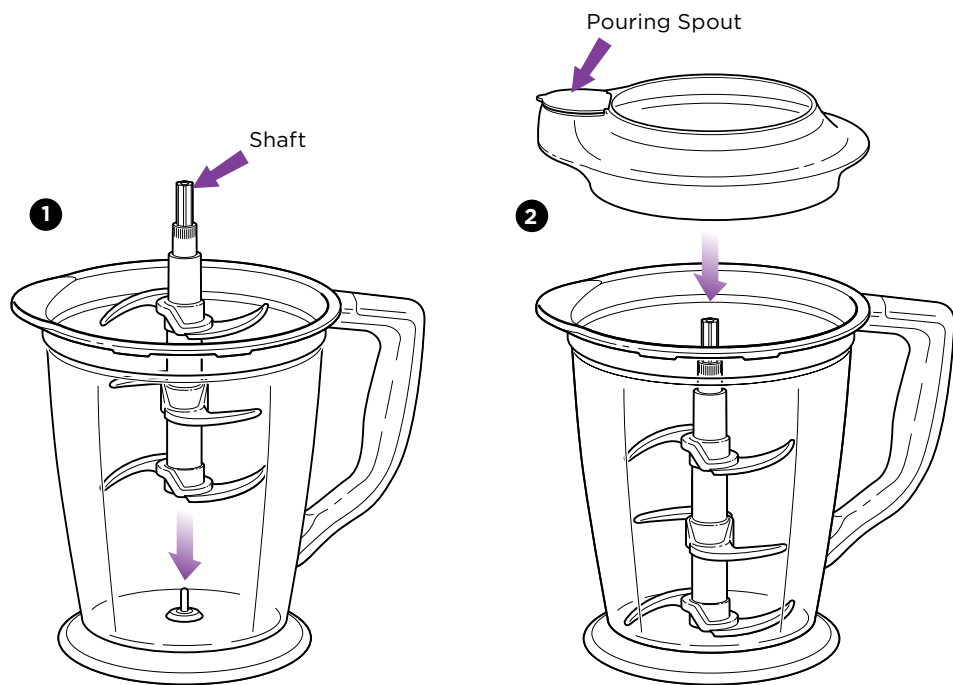

CAUTION: Blades are sharp! Use extreme caution when handling the blades. Always hold them by the shaft.

IMPORTANT: Never run the appliance empty.

- 1 Place the Master Prep™ Professional pitcher on a clean, dry, level surface.
- 2 Holding the Ninja™ 6-Blade by the shaft, place it onto the spindle pin inside the Master Prep™ Professional pitcher. (fig. 1)

IMPORTANT: Place Ninja™ 6-Blade inside the container carefully as blades are sharp.

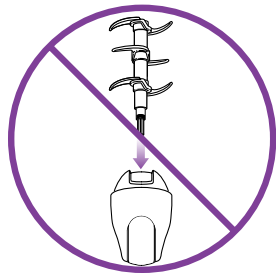

WARNING: DO NOT try to place the Ninja™ 6-Blade onto the power head and then into the Master Prep™ Professional pitcher.

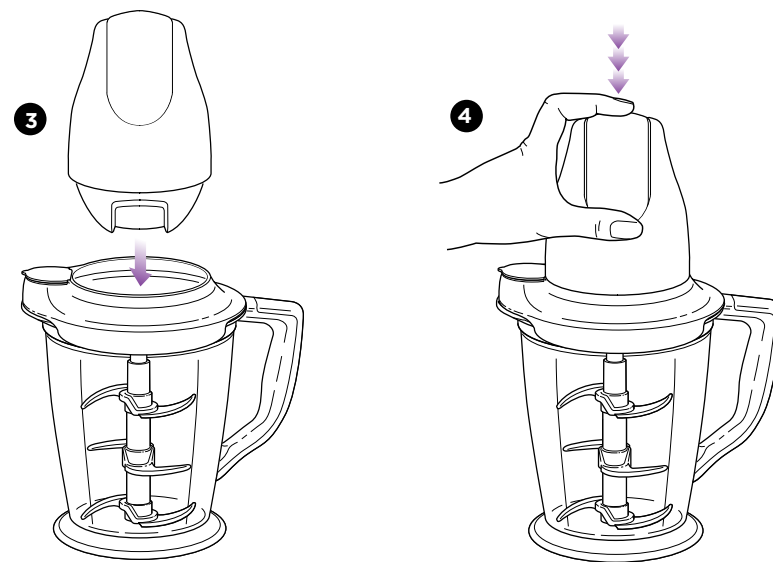

- 3 Add the ingredients to be processed into the Master Prep™ Professional pitcher.

IMPORTANT: Never add ingredients into the Master Prep™ Professional pitcher before placing the blades in first.

- 4 Place the pitcher splash guard onto the top of the Master Prep™ Professional pitcher. (fig. 2)

- 5 Place the power head on top of the pitcher splash guard making sure that it is securely in place. (fig. 3) **DO NOT** attempt to operate the appliance without the safety splash guard in place.

- 6 To start the appliance, plug the power cord into the electrical outlet, securely hold power head while operating and press on the on/off pulse button located on the top of the power head. (fig. 4)

- 7 Hold the Master Prep™ Professional pitcher firmly while depressing the on/off pulse button to ensure the unit stays in place.

NOTE: DO NOT operate the appliance continuously for more than 15 seconds at a time.

- 8 To stop the appliance, remove your fingers from the on/off pulse button.
- 9 In order to obtain a better quality of chopping, operate the appliance by using the “pulse” method.
- 10 Make sure that the blades have stopped completely before removing the power head.
- 11 If the ingredients stick to the side of the Master Prep™ Professional pitcher, stop the appliance, remove the power head and the splash guard. Use a spatula to dislodge the pieces and then replace the splash guard and the power head. Continue processing.
- 12 Depending on the consistency of the contents, use the pouring spout to empty liquid contents.
- 13 For thicker consistencies, first remove splash guard and Ninja™ 6-Blade (by its shaft), then empty contents of the Master Prep™ Professional pitcher.

Using the Master Prep™ Professional Bowl

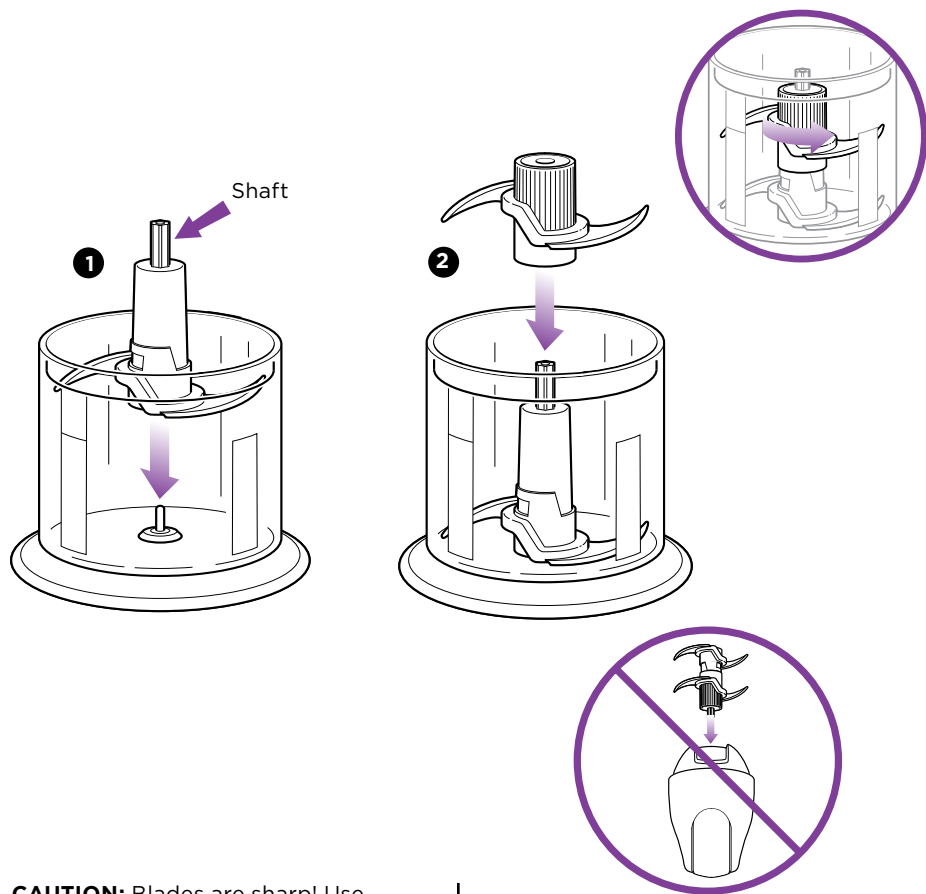

⚠ CAUTION: Blades are sharp! Use extreme caution when handling the blades. Always hold them by the shaft.

⚠ IMPORTANT: Never run the appliance empty.

- 1 Place the Master Prep™ Professional bowl on a clean, dry, level surface.
- 2 Holding the lower blade by the shaft, place it over the spindle pin inside the Master Prep™ Professional bowl. (fig. 1)
- 3 Carefully insert the upper blade over the lower blade rotating it until it locks onto the lower blade. (fig. 2)

⚠ IMPORTANT: Always assemble the blades inside the container.

⚠ WARNING: DO NOT try to place the blades onto the power head and then into the Master Prep™ Professional bowl.

- 4 Place the food that you want to process into the Master Prep™ Professional bowl.

⚠ IMPORTANT: Never add ingredients into the Master Prep™ Professional bowl before placing the blade assembly in first.

NOTE: DO NOT add more than 2 cups dry or 1 cup liquid ingredients as this will strain the motor and may cause overflow.

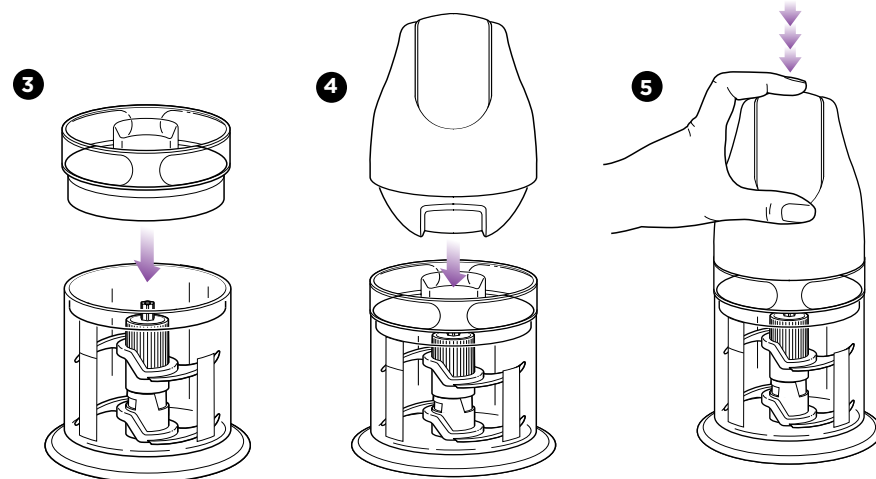

- 5 Place the splash guard on the bowl. (fig. 3)

- 6 Place the power head on top of the splash guard making sure that it is securely in place. (fig. 4) **DO NOT** attempt to operate the appliance without the safety splash guard in place.

- 7 To start the appliance, plug the power cord into the electrical outlet, securely hold power head while operating and press on the on/off pulse button located on the top of the power head. (fig. 5)

- 8 Hold the Master Prep™ Professional bowl firmly while depressing the on/off pulse button to ensure the unit stays in place.

NOTE: DO NOT operate the appliance continuously for more than 15 seconds at a time. Be careful not to over process. For coarsely chopped foods, use repeated short pulsing action until the desired consistency is reached.

- 9 To stop the appliance, remove your fingers from the on/off pulse button.
- 10 In order to obtain a better quality of chopping, operate the appliance by using the “pulse” method.

- 11 Make sure that the blades have stopped completely before removing the power head.

- 12 If the ingredients stick to the side of the Master Prep™ Professional bowl, stop the appliance, remove the power head and the splash guard. Use a spatula to dislodge the pieces and then replace the splash guard and the power head. Continue processing.

- 13 Remove the blade assembly by its shaft before you empty the contents of the Master Prep™ Professional bowl.

HINTS & TIPS FOR USING YOUR NINJA™ MASTER PREP™ PROFESSIONAL

- The chopping blades can be used for chopping meat, fish, vegetables, cheese etc.
- For mincing, chopping and pureeing, increase the length of pulses.
- For coarse chopping, use short, quick pulses and monitor food texture.
- Pre-cut larger pieces to make them fit into the Master Prep™ Professional. When chopping hard foods (e.g. meat, cheese) cut into 1-inch cubes.
- To crush ice into snow, start by using short pulses to break up large chunks. Continue until snow is achieved.

Cleaning and Maintenance

CAUTION: Make sure that the power head is unplugged from power source before inserting or removing any attachment and before cleaning.

DO NOT immerse the power head into water or any other liquid. Clean with a damp sponge or cloth and wipe dry.

The Master Prep™ *Professional* pitcher, Master Prep™ *Professional* bowl, storage lids, Master Prep™ *Professional* splash guards and chopping blades are all dishwasher safe. It is recommended to place the storage lids and the chopping blades on the top rack. Use extreme caution when handling the chopping blades as they are very sharp.

Clean the Ninja™ Master Prep™ *Professional* and all parts before first use and immediately after each use.

Troubleshooting Guide

PROBLEMS	POSSIBLE REASONS & SOLUTIONS
Motor Doesn't Start or Blades Don't Rotate.	<p>Check that the bottom of motor head is clean and there is no food blocking connection when placing on containers.</p> <p>There is too much food in the container.</p> <p>The unit has overheated. Unplug and wait approximately 10 minutes before using again.</p> <p>Make sure the splash guard is securely on container.</p> <p>Make sure the power head is securely placed on splash guard.</p> <p>Check that the plug is securely inserted into the electrical outlet.</p> <p>Check fuse or breaker. Replace fuse/reset breaker.</p>
Food is Unevenly Chopped.	<p>Either you are chopping too much food at one time, or the pieces are not small enough. Try cutting the food into smaller pieces of even size and processing smaller amounts per batch.</p>
Food is Chopped Too Fine or is Too Watery.	<p>The food has been over processed. Use brief pulses or process for shorter time. Let blades stop completely between pulses.</p>
Food Collects On Splash Guard/Safety Cover or On the Sides of the Master Prep™ Professional Pitcher or Master Prep™ Professional Bowl.	<p>You may be processing too much food. Turn the machine off. When the blades stop rotating, remove the power head and the splash guard. Remove some of the food being processed.</p>
You Cannot Achieve Snow From Solid Ice	<p>Do not use ice that has been sitting out or has started to melt. Be sure to use short pulses in the beginning to break up large pieces.</p>

To purchase replacement parts, please visit our website: www.ninjakitchen.com or contact customer service: 1-800-798-7398

Models
QB1000 30
QB1000CO 30
QB1002 30
QB1003 30

EURO-PRO

English

ONE (1) YEAR LIMITED WARRANTY

EURO-PRO Operating LLC warrants this product to be free from material defects and workmanship for a period of one (1) year from the date of purchase when utilized for normal household use, subject to the following conditions, exclusions and exceptions.

The liability of **EURO-PRO Operating LLC** is limited solely to the cost of the repair or replacement of the unit at our option. This Limited Warranty does not cover normal wear of parts and does not apply to any unit that has been tampered with or used for commercial purposes. This Limited Warranty does not cover damage caused by misuse, abuse, negligent handling or damage due to faulty packaging or mishandling in transit. This Limited Warranty does not cover damage or defects caused by or resulting from damages from shipping or repairs, service or alteration to the product or any of its parts, which have been performed by a repair person not authorized by **EURO-PRO Operating LLC**.

If your appliance fails to operate properly while in use under normal household conditions within the Limited Warranty period, you may return the complete appliance and accessories with proof of purchase and date, freight prepaid. For Customer Service support, call 1-800-798-7398 or visit our website www.ninjakitchen.com.

If the appliance is found by **EURO-PRO Operating LLC** to be defective, in **EURO-PRO Operating LLC's** sole discretion, we will repair or replace it free of charge. Proof of purchase date and cheque made payable to **EURO-PRO Operating LLC** in the amount of \$14.95 to cover the cost of return shipping and handling must be included.*

This Limited Warranty is extended to the original purchaser of the unit and excludes all other legal, implied and/or conventional warranties. The responsibility of **EURO-PRO Operating LLC** if any, is limited to the specific obligations expressly assumed by it under the terms of this Limited Warranty. **In no event is EURO-PRO Operating LLC** liable for incidental or consequential damages to anyone of any nature whatsoever. Some states do not permit the exclusion or limitation of incidental or consequential damages, so the above may not apply to you.

This Limited Warranty gives you specific legal rights, and you may also have other rights which vary from state to state or from province to province.

***IMPORTANT: Carefully pack item to avoid damage in shipping. Be sure to include proof of purchase date and to attach tag to item before packing with your name, complete address and phone number with a note giving purchase information, model number and what you believe is the problem with the item. We recommend you insure the package (as damage in shipping is not covered by your Limited Warranty). Mark the outside of your package "ATTENTION CUSTOMER SERVICE". We are constantly striving to improve our products, therefore the specifications contained herein are subject to change without notice.**

U.S.: EURO-PRO Operating LLC
Newton, MA 02459

CANADA: EURO-PRO Operating LLC
4400 Bois Franc
Ville St. Laurent, Québec H4S 1A7
1-800-798-7398
www.ninjakitchen.com

COPYRIGHT © EURO-PRO OPERATING LLC 2010

PRINTED IN CHINA REV. 100113

Illustrations may differ with actual product.