Outdoor Patio Heater

Model # 61279,61301,61304,61281,61283,61285,61307
61287,61299,61312,61731,61732,61733,61734



ATTACH YOUR RECEIPT HERE

Serial Number _____ **Purchase Date** _____



Questions, problems, missing parts? Before returning to your retailer, call our customer service hotline at **1-866-985-7877**, 9 a.m. – 6 p.m., EST, Monday – Friday or email at cservice@welltraveled.net.







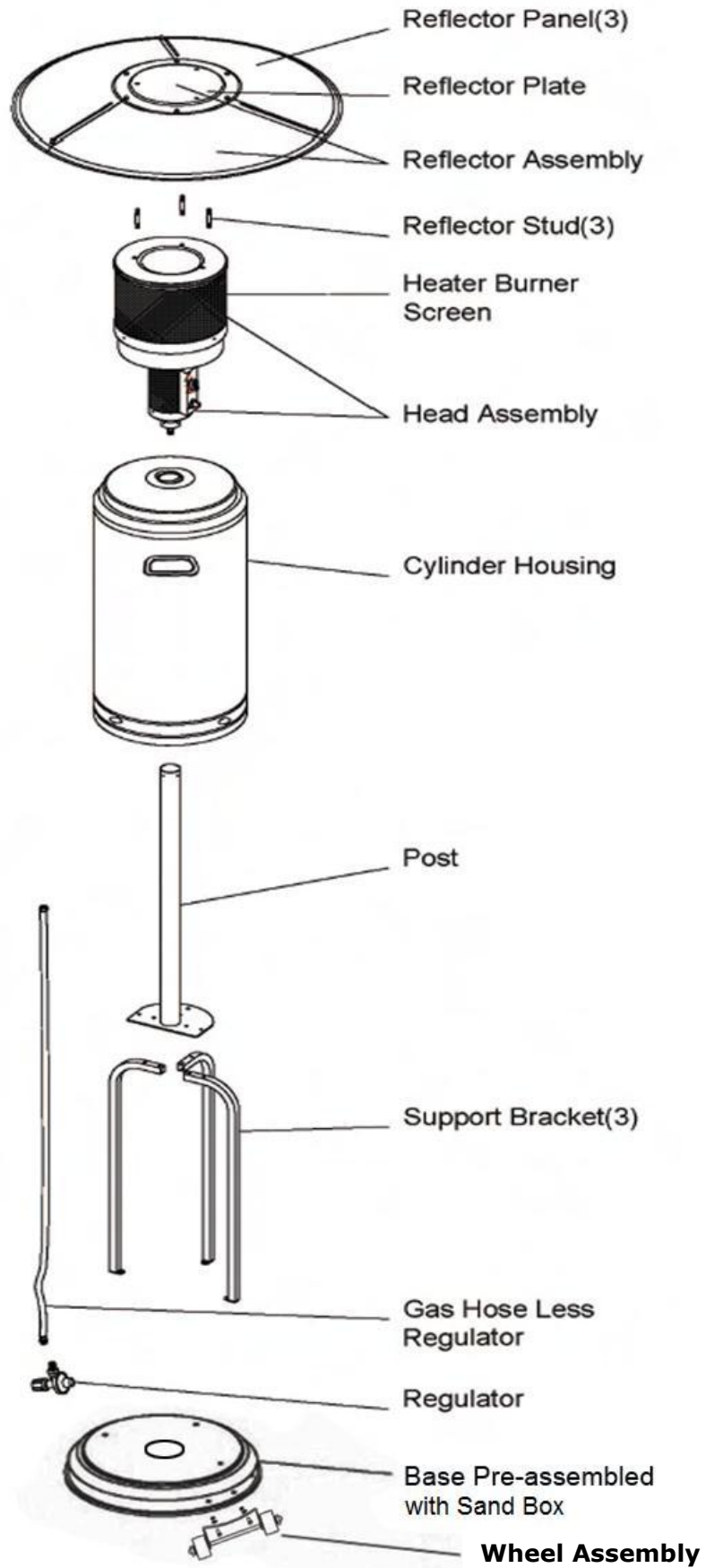





TABLE OF CONTENTS

Package Contents.....	Page 3
Hardware	Page 4
Safety Information.....	Page 4-6
Assembly.....	Page 6-10
Operating Instructions.....	Page 11-13
Care and Maintenance.....	Page 14
Troubleshooting.....	Page 15
Warranty.....	Page 16

PACKAGE CONTENTS



HARDWARE

	Description	Qty	Used in Step(s)		Description	Qty	Used in Step(s)
	Large Bolt	6	3		Small Flange Nut	6	3
	Medium Bolt	5	1 and 2		Large Nut (pre-assembled to base with sand box)	4	/
	Small Bolt (pre-assembled in head unit)	4	6		Cap Nut	9	7
	Lock Washer (pre-assembled in head unit)	4	6		Wing Nut	3	8
	Large Screw (pre-assembled to base with sand box)	4	/		Reflector Stud	3	5
	Small Screw	9	7		Wrench	1	As needed
	Large Flat Washer	9	5 and 8				

SAFETY INFORMATION

SAFETY INFORMATION

Please read and understand this entire manual before attempting to assemble, operate or install this appliance. If you have any questions regarding the product, please call customer service at **1-866-985-7877**, 9 a.m. – 6 p.m., EST, Monday – Friday.

This manual contains important information about the assembly, operation and maintenance of this patio heater. General safety information is presented in the first few pages and is also located throughout this manual. Keep this manual for future reference and to educate new users of this appliance. This manual should be read in conjunction with the labeling on the appliance. Safety precautions are essential when any mechanical or propane fueled equipment is involved. These precautions are necessary when using, storing, and servicing this appliance. Using this appliance with the respect and caution demanded will reduce the possibilities of personal injury or property damage. The following symbols shown below are used extensively throughout this manual. Always heed these precautions, as they are essential when using any mechanical or propane fueled equipment.



DANGER indicates an imminently hazardous situation which, if not avoided, will result in death or serious injury.



FOR YOUR SAFETY:
If you smell gas:
1. Shut off gas to the appliance.
2. Extinguish any open flame.
3. If odor continues, keep away from the appliance and immediately call your gas supplier or fire department.



Failure to comply with the precautions and instructions provided with this heater can result in death, serious bodily injury and property loss or damage from hazards of fire, explosion, burn, asphyxiation, and/or carbon monoxide poisoning. Only persons who can understand and follow the instructions should use or service this heater.

 **DANGER***** EXPLOSION – FIRE HAZARD**

- * Keep solid combustibles, such as building materials, paper, or cardboard a safe distance away from the heater as recommended by the instructions.
- * Provide adequate clearances around air openings into the combustion chamber.
- * Never use the heater in spaces which do or may contain volatile or airborne combustibles, or products such as gasoline, solvents, paint thinner, dust particles or unknown chemicals.
- * During operation, this appliance can be a source of ignition. Keep heater area clear and free from combustible materials, gasoline, paint thinner, cleaning solvents and other flammable vapors and liquids. Do not use heater in areas with high dust content. Minimum heater clearances from combustible materials: three (3) feet or 36 inches from top and two (2) feet or 24 inches from sides.

 **DANGER***** EXPLOSION – FIRE HAZARD**

- * Never store propane near high heat, open flames, pilot lights, direct sunlight, other ignition sources or where temperatures exceed 120 degrees F (49 degrees C).
- * Propane vapors are heavier than air and can accumulate in low places. If you smell gas, leave the area immediately.
- * Never install or remove propane cylinder while heater is lighted, near flame, pilot lights, or other ignition sources or while heater is hot to the touch.
- * This heater is red hot during use and can ignite flammables too close to the burner. Keep flammables at least 3 feet (36 inches) from top and 2 feet (24 inches) from sides. Keep gasoline and other flammable liquids and vapors well away from heater.
- * Store the propane cylinder outdoors in a well ventilated space out of the reach of children. Never store the propane cylinder in an enclosed area (house, garage, etc.). If heater is to be stored indoors, disconnect the propane cylinder for outdoor storage.

 **WARNING**

We cannot foresee every use which may be made of our heaters. Check with your local fire safety authority if you have questions about heater use. Other standards govern the use of fuel gasses and heat producing products for specific uses. Your local authorities can advise you about these. If no local codes exist, follow National Fuel Gas Code, ANSI Z223.1. In Canada, installation must conform to local codes. If no local codes exist, follow the current National standards of CANADA CAN/CGA-B 149.2.

 **DANGER***** CARBON MONOXIDE HAZARD**

- * This heater is a combustion appliance. All combustion appliances produce carbon monoxide (CO) during the combustion process. This product is designed to produce extremely minute, non-hazardous amounts of CO if used and maintained in accordance with all warnings and instructions. Do not block the air flow into or out of the heater.
- * Carbon Monoxide (CO) poisoning produces flu-like symptoms, watery eyes, headaches, dizziness, fatigue and possibly death. You can't see and you can't smell it. It is an invisible killer. If these symptoms are present during operation of this product get fresh air immediately!
- * For outdoor use only.
- * Never use inside house or other unventilated or enclosed areas.
- * This heater consumes air (oxygen). Do not use in unventilated or enclosed areas to avoid endangering your life.

 **WARNING**

WARNING indicates an imminently hazardous situation which, if not avoided, will result in death or serious injury.

 **WARNING**

Do not store or use gasoline or other flammable vapors and liquids in the vicinity of this or any other appliance. An LP-cylinder not connected for use shall not be stored in the vicinity of this or any other appliance.

 **WARNING:** FOR OUTDOOR USE ONLY**CARBON MONOXIDE HAZARD**

This appliance can produce carbon monoxide which has no odor. Using it in an enclosed space can kill you. Never use this appliance in an enclosed space such as a camper, tent or home.

 **WARNING**

Improper installation, adjustment, alteration, service or maintenance can cause property damage, injury or death. Read the installation, operation and maintenance instructions thoroughly before installing or servicing this equipment.

SAFETY INFORMATION

WARNING

California Proposition 65
Combustion by-products produced when using this product contain chemicals known to the State of California to cause cancer, birth defects, and other reproductive harm.

WARNING

BURN HAZARD

- * Never leave heater unattended when hot or in use.
- * Keep out of reach of children.

WARNING

Certain materials or items, when stored under the heater, will be subject to radiant heat and could be seriously damaged.

CAUTION

SERVICE SAFETY

- * Keep all connections and fittings clean. Make sure propane cylinder valve outlet is clean.
- * During set up, check all connections and fittings for leaks using soapy water. Never use a flame to check for leaks.
- * Use as a heating appliance only. Never alter in any way to use with any device.

CAUTION

CAUTION indicates an imminently hazardous situation which, if not avoided, may result in minor or moderate personal injury, or property damage.

WARNING

* This product is fueled by propane gas. Propane gas is invisible, odorless, and flammable. An odorant is normally added to help detect leaks and can be described as having a "rotten egg" smell. The odorant can fade over time so leaking gas is not always detectable by smell alone.

* Propane gas is heavier than air and leaking propane will sink to the lowest level possible. It can ignite by ignition sources including matches, lighters, sparks or open flames of any kind many feet away from the original leak. Use only propane gas set up for vapor withdrawal.

* Store or use propane gas in compliance with local ordinances and codes or with ANSI/NFPA 58. Turn off propane when not in use.

WARNING

* Alert children and adults to the hazards of high surface temperatures. Stay away from these surfaces to avoid burning skin or igniting clothing.

* Carefully supervise young children when in the vicinity of the heater.

* Do not hang clothing or any other flammable materials from the heater, or place near the heater.

* Replace any guard or protective device removed for servicing the appliance prior to placing back in service.

* Installation and repair should be done by a qualified service person. The heater should be inspected before use and annually by a qualified service person. More frequent cleaning may be required as necessary. It is imperative that the control compartment, burners, and circulating air passageway of the appliance be kept clean.

ASSEMBLY

PREPARATION

Before beginning assembly of this appliance, make sure all parts are present. Compare all parts with package contents list and hardware as listed on pages 3 and 4 of this manual. If any part is missing or damaged, do not attempt to assemble this product. Contact customer service for replacement parts.

ESTIMATED ASSEMBLY TIME: 60 minutes

Tools Required for Assembly (NOT included):

7/16" open-end wrench

Philips screwdriver with medium blade

Adjustable opening wrench

Leak Detection Solution (see instructions on page 11 on how to make solution.)

ASSEMBLY

1. Attach Wheel Assembly to Base. Line up holes in Wheel Assembly with corresponding holes in Base and insert 2 - Medium Bolts through holes. Finger tighten bolts. Be sure that Wheel Assembly is parallel to the Base and fully tighten the bolts.

Note: For best stability, fill the sand box with sand.

Hardware Used:

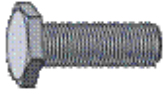

2 Medium Bolts



2. Attach the Support Brackets to the Base. Attach the 3 - Support Brackets loosely to the Base with 3 - Medium Bolts inserted through the holes in the bottom of the Support Brackets and into the Base.

Hardware Used:

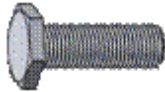

3 Medium Bolts



3. Attach the Post to the Support Brackets. Once you have tightened the bolts holding the Support Brackets to the Base, align the holes in the bottom of the Post with the holes on the tops of the Support Brackets and insert 6 - Large Bolts through the hole in the Post and through the hole in the Support Bracket. Affix 6 - Small Flange Nuts to the bottom of the Large Bolts. Hand tighten initially then tighten with a wrench when all bolts have been inserted.

Hardware Used:



6 Large Bolts

6 Small Flange Nuts

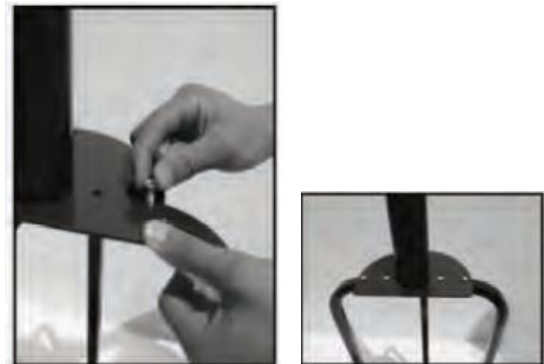

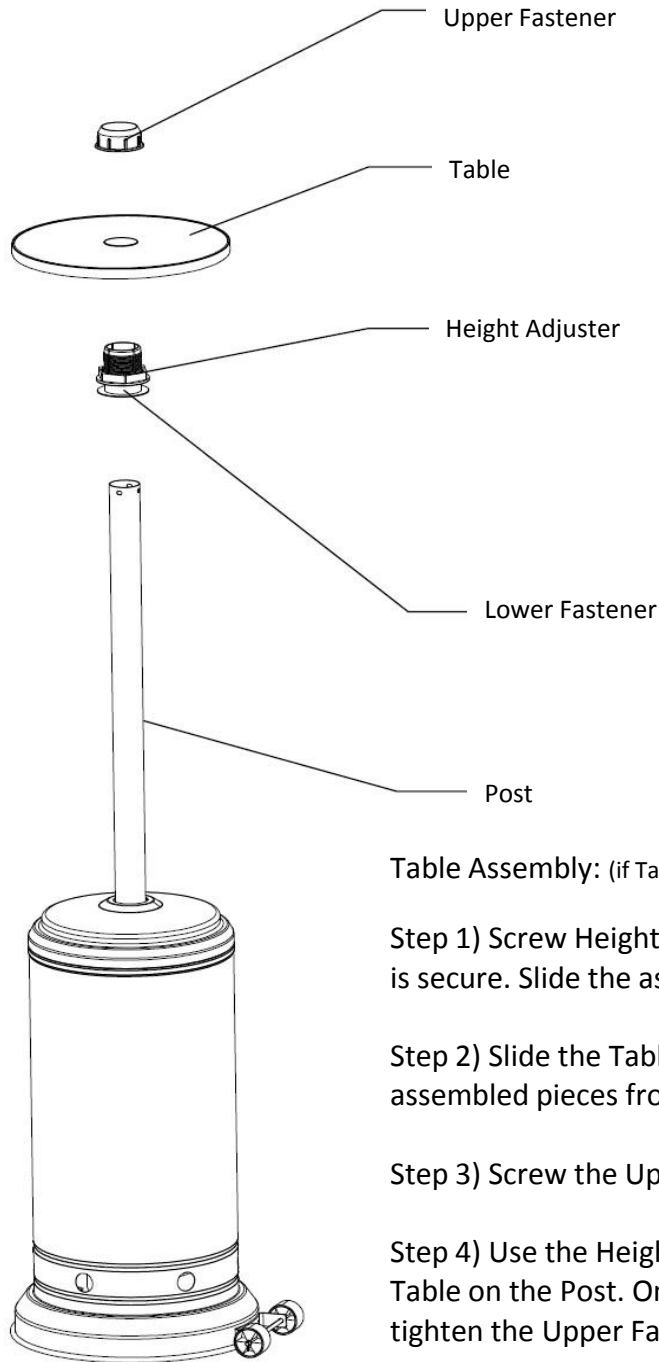

Table Assembly: (if Table is included)

Step 1) Screw Height Adjuster onto the Lower Fastener until it is secure. Slide the assembled pieces onto the Post.

Step 2) Slide the Table on the Post and rest the Table on the assembled pieces from Step 1.

Step 3) Screw the Upper Fastener into the Lower Fastener.

Step 4) Use the Height Adjuster to adjust the height of the Table on the Post. Once the Table is at the desired height, tighten the Upper Fastener to secure the table.

ASSEMBLY

4. Place Cylinder Housing onto Post. Slide Cylinder Housing down over Support Brackets and Post and rest on Base.



5. Attach Reflector Studs to Screen Cover. Insert 3 Reflector Studs through washers and into holes on screen cover. Tighten studs securely.

Hardware Used:



3 Reflector Studs



3 Large Flat Washers



6. Attach Head Assembly to Post. Unscrew 4 Small Bolts and 4 Lock Washers pre-assembled in the Head Assembly. Route Gas Hose down into post and then place Head Assembly on top of Post.

Note: Control knob should be above the decal on Post.

Attach Head Assembly to Post by inserting bolts through lock washers and into holes on Head Assembly and Post. Once all bolts and lock washers have been inserted, tighten securely.



Hardware Used:

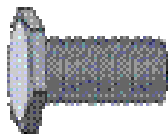

4 Small Bolts



4 Lock Washers



ASSEMBLY

7. Install Reflector. NOTE: MAKE SURE TO REMOVE PROTECTIVE PLASTIC COVER ON REFLECTOR PIECES PRIOR TO ASSEMBLY!

Assembly Tip: If necessary for proper alignment of reflector sections, loosen each screw prior to further assembly and retighten after sections are aligned.

Slide two Reflector Panels together. Insert one Small Screw. Screw on Cap Nut loosely.

Repeat with the third Reflector Panel.

Slide Reflector Plate onto assembled Reflector Panels. Insert one Small Screw and screw on Cap Nut loosely. Repeat with two more Small Screws and Cap Nuts to complete reflector assembly. Fully tighten all of the screws and cap nuts.

Hardware Used:

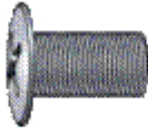

9 Small Screws

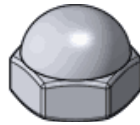

9 Cap Nuts

8. Attach Reflector Assembly to heater. While supporting heater, tilt the Head Assembly and slide 3 Large Flat Washers over the Reflector Studs. Place the Reflector Assembly onto the Reflector Studs and slide 3 Large Flat Washers over Reflector Studs and onto Reflector Assembly. Secure with 3 Wing Nuts. Do NOT over tighten. Once you have tightened the Wing Nuts, return the heater to an upright position.

Hardware Used:



6 Large Flat Washers



3 Wing Nuts

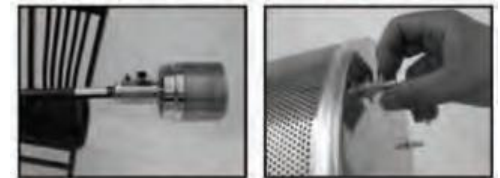
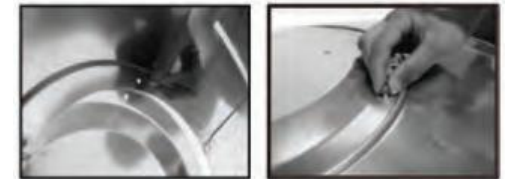
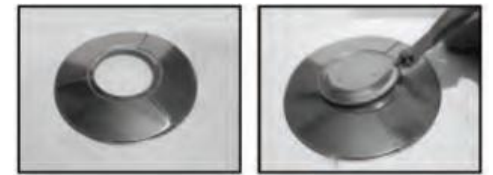
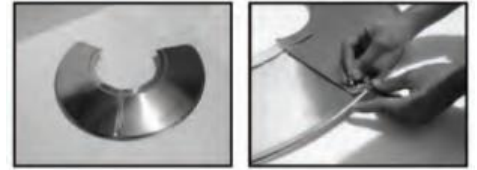

ASSEMBLY

9. Connect the Hose and Regulator to the LP cylinder. The LP cylinder is sold separately. Use a standard 20 lb. propane cylinder only. Lift the Cylinder Housing up and rest it on the top of the assembled Support Brackets. Screw Regulator onto Gas Hose. Do not cross thread. Hand tighten securely. Attach Regulator to valve on LP cylinder and hand tighten securely. Place LP tank onto base of heater and lower Cylinder Housing.

NOTE: Use this heater only with a propane vapor withdrawal supply system. See Chapter 5 of the standard for storage and handling of liquefied petroleum gas, ANSI/NFPA 58. Your local library or fire department should have this book.

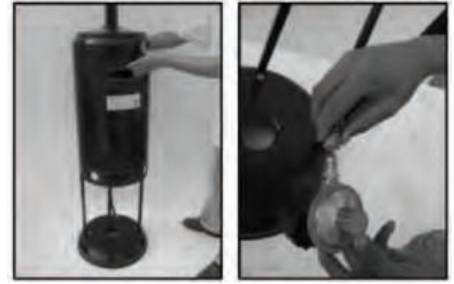

A minimum supply pressure of .5 psi is required for the purpose of input adjustment of propane gas. Storage of an appliance indoors is permissible only if the cylinder is disconnected and removed from the appliance. A cylinder must be stored outdoors in a well-ventilated area out of the reach of children. A disconnected cylinder must have dust caps tightly installed and must not be stored in a building, garage, or any other enclosed area. The minimum permissible gas supply pressure of 11 W.C. is required for purpose of hose adjustment. The minimum hourly of 17,500 BTU is required input rating for a heater for automatic operation rating less than full input rating.

The pressure regulator and hose assembly supplied with the appliance must be used.

The installation must conform with local codes, or in the absence of local codes, with national fuel gas code, ANSI Z223.1/NFPA54, natural gas and propane Installation Code, CSA B149.1, or propane storage and handling code, B149.2

A dented rusted or damaged propane cylinder may be hazardous and should be checked by your local cylinder supplier. Never use a propane cylinder with a damaged valve connection.

The propane cylinder must be constructed and marked in accordance with the specifications for LP gas cylinders of the U.S. Department of Transportation (DOT) or the standard for cylinders, spheres and tubes for transportation of dangerous goods and commission, CAN/CSA-B339.

The cylinder must have a listed overfilling prevention device.

The cylinder must have a connection device compatible with the connection for the appliance.

The cylinder used must include a collar to protect the cylinder valve.

Never connect an unregulated propane cylinder to the heater.

- Do not store a spare LP-gas cylinder under or near this appliance.
- Never fill the cylinder beyond 80 percent full.
- Place the dust cap on the cylinder valve outlet whenever the cylinder is not in use. Only install the type of dust cap on the cylinder valve that is provided with the cylinder valve. Other types of caps or plugs may result in leakage of propane.

Leak Test

 WARNING
<ul style="list-style-type: none"> * Perform all leak tests outdoors. * Extinguish all open flames. * NEVER leak test when smoking. * Do not use heater until all connections have been leak tested and show no signs of leakage.



1. Make 2-3 oz. of leak test solution (one part liquid dishwashing detergent and three parts water).
2. Apply several drops of solution where hose attaches to regulator.
3. Apply several drops of solution where regulator connects to cylinder.
4. Make sure all patio heater valves are OFF.
5. Turn cylinder valve ON.

IF BUBBLES APPEAR AT ANY CONNECTION, THERE IS A LEAK.

1. Turn cylinder valve OFF.
2. If leak is detected at hose/regulator connection, tighten connection and perform another leak test. If bubbles continue to appear, call our customer service hotline at **1-866-985-7877**, 9 a.m. – 6 p.m., EST, Monday – Friday.
3. If leak is detected at regulator/cylinder valve connection, disconnect, reconnect, and perform another leak test. If you continue to see bubbles after several attempts, cylinder valve is defective. Call our customer service hotline at **1-866-985-7877**, 9 a.m. – 6 p.m., EST, Monday – Friday

IF NO BUBBLES APPEAR AT ANY CONNECTION, THE CONNECTIONS ARE SECURE.

Note: Whenever gas connections are loosened or removed, you must perform a complete leak test.

 WARNING: FOR OUTDOOR USE ONLY
 <p>CARBON MONOXIDE HAZARD</p> <p>This appliance can produce carbon monoxide which has no odor. Using it in an enclosed space can kill you. Never use this appliance in an enclosed space such as a camper, tent or home.</p>

Caution: Do not attempt to operate this appliance until you have read and understand all Safety Information in this manual and all assembly is complete and leak tests have been performed.

Before Turning Gas Supply ON:

1. Your heater was designed and approved for OUTDOOR use only. Do NOT use it inside a building, garage, or any other enclosed area.
2. Make sure surrounding areas are free of combustible materials, gasoline, and other flammable vapors or liquids.
3. Ensure that there is no obstruction to air ventilation. Be sure all gas connections are tight and there are no leaks.
4. Be sure the cylinder cover is clear of debris. Be sure any component removed during assembly or servicing is replaced and fastened prior to starting.

Before Lighting:

1. Heater should be thoroughly inspected before each use, and by a qualified service person at least annually. If re-lighting a hot heater, always wait at least 5 minutes.
2. Inspect the hose assembly for evidence of excessive abrasion, cuts, or wear. Suspected areas should be leak tested. If the hose leaks, it must be replaced prior to operation. Only use the replacement hose assembly specified by the manufacturer.

Lighting:

NOTE: This heater is equipped with a Pilot Light that allows for safer startups and shutdowns. Pilot **MUST** be lit before Main Burner can be started. For initial start or after any cylinder change, hold the control knob in for 2 minutes to purge air from all gas lines before proceeding.

1. Turn the Control Knob to the "OFF" position.
2. Fully open the LP cylinder valve.
3. Open the Viewing Hole by sliding the cover to the left.
4. Push Control Knob in and rotate to Pilot position.
5. Push and release the Igniter Button on the control panel until flame is visible through Viewing Hole.
6. Release Control Knob after 30-60 seconds. Pilot light will remain lit. If not, return to Step 1.
7. Turn Control Knob to ON. Main Burner will light immediately. Flame is visible through Viewing Hole. If not, return to Step 1.
8. To increase the flame, turn the Control Knob counter clockwise to HI. To decrease the flame, turn the Control Knob clockwise to LO.

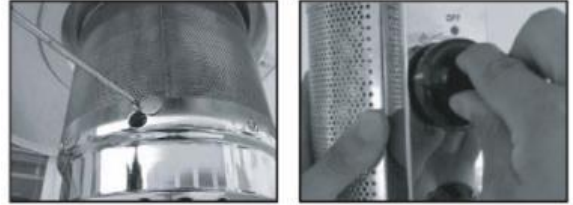

If your some reason your igniter fails to deliver a spark, your heater can be started by inserting a lit match or stick lighter through the pilot Viewing Hole while pushing the Control Knob in while it is in the Pilot position.

NOTE: If Pilot fails to remain lit, all valves should be closed and a waiting period of at least 5 minutes should pass before attempting to re-light.

9. To turn the appliance OFF, push down the Control Knob and turn clockwise to the Pilot position. Burner will extinguish but Pilot will remain On. To extinguish Pilot, press in the Control Knob and continue to turn clockwise to OFF.
7. Wait at least 5 minutes before attempting to re-light the heater.
8. Turn the gas cylinder valve to OFF or closed.

If you experience any ignition problems, please consult "Troubleshooting" on page 15.

Caution: Avoid inhaling fumes emitted from the heater's first use. Smoke and odor from the burning of oils used in the manufacturing will appear. Both smoke and odor will dissipate after approximately 30 minutes. The heater should NOT produce thick black smoke.

 WARNING
<p>FOR YOUR SAFETY Be careful when attempting to manually ignite this heater. Holding in the control knob for more than 10 seconds before igniting the gas will cause a ball of flame upon ignition.</p>

When Heater is ON:

Emitter screen will become bright red due to intense heat. The color is more visible at night. Burner will display tongues of blue and yellow flame. These flames should not be yellow or produce thick black smoke, indicating an obstruction of airflow through the burners. The flame should be blue with straight yellow tops. If excessive yellow flame is detected, turn off heater and consult "Troubleshooting" on page 15.

Re-Lighting:

Note: For your safety, control knob cannot be turned OFF without first depressing the control knob and then rotating to OFF.

1. Turn control knob to OFF.
2. Wait at least 5 minutes to allow gas to dissipate before re-lighting.
3. Repeat the "Lighting" steps as listed above.



FOR YOUR SAFETY

Heater will be hot after use. Handle with extreme care.

Shut Down:

1. Turn Control Knob clockwise to Pilot while depressing the knob (normally, burner will make a slight popping noise when extinguished.) Burner will extinguish but Pilot will remain lit.
2. To extinguish Pilot, press in Control Knob and continue to turn clockwise to OFF.
2. Turn cylinder valve clockwise to OFF and disconnect regulator when heater is not in use.

NOTE: After use, some discoloration of the emitter screen is normal.

Operation Checklist:

For a safe and pleasurable heating experience, perform this check before each use:

Before Operating:

1. I am familiar with entire owner's manual and understand all precautions noted.
2. All components are properly assembled, intact and operable.
3. No alterations have been made.
4. All gas connections are secure and do not leak.
5. Wind velocity is below 10 mph.
6. Unit will operate at reduced efficiency below 40 degrees F.
7. Heater is for use outdoors (outside any enclosure).
8. There is adequate fresh air ventilation.
9. Heater is away from gasoline or other flammable liquids or vapors.
10. Heater is away from windows, air intake openings, sprinklers and other water sources.
11. Heater is at least 36 in. on top and at least 24 in. on sides from combustible materials.
12. Heater is on a hard and level surface.
13. There are no signs of spider or insect nests in heater orifices.
14. All burner passages are clear.
15. All air circulation passages are clear.
16. Children and adults should be alerted to the hazards of high surface temperatures and should stay away to avoid burns or clothing ignition.
17. Young children should be carefully supervised when they are in the area of the heater.
18. Clothing or other protective material should not be hung from the heater, or placed on or near the heater.
19. Any guard or other protective device removed for servicing the heater must be replaced prior to operating the heater.
20. Installation and repair should be done by a qualified service person. The heater should be inspected before each use and at least annually by a qualified service person.
21. More frequent cleaning may be required as necessary. It is imperative that control compartment burner and circulating air passageways of the heater be kept clean and free of debris and/or spider or insect nests.

After Operation:

1. Gas Control Knob is in OFF position.
2. Gas tank valve is OFF.
3. Disconnect gas line.
4. Heater is in upright secure location.

WARNING
FOR YOUR SAFETY

- * Do NOT touch or move heater for at least 45 minutes after use.
- * Reflector is hot to the touch.
- * Allow reflector to cool before touching.

To enjoy years of outstanding performance from your heater, make sure you perform the following maintenance activities on a regular basis:

Keep exterior surfaces clean.

1. Use soapy water for cleaning. Never use flammable or corrosive cleaning agents.
2. While cleaning your unit, be sure to keep the area around the burner and control compartment dry at all times. Do not submerge the control valve assembly. If the gas control is submerged in water, do NOT use it. It must be replaced.
3. Air flow must be unobstructed. Keep controls, burner, and circulating air passageways clean. Signs of possible blockage include:
 - Gas odor with extreme yellow tipping of flame.
 - Heater does NOT reach the desired temperature.
 - Heater glow is excessively uneven.
 - Heater makes popping noise.
 - Spiders and insects can nest in burner or orifices. This dangerous condition can damage heater and render it unsafe for use. Clean burner holes by using a heavy-duty pipe cleaner. Compressed air may help clear away smaller particles.
 - Carbon deposits may create a fire hazard. Clean dome and burner screen with warm soapy water if any carbon deposits develop.

Note: In a salt-air environment (such as near an ocean), corrosion occurs more quickly than normal. Frequently check for corroded areas and repair them promptly.

TIP (FOR STAINLESS STEEL MODELS):

Use high-quality automobile wax to help maintain the appearance of your heater. Apply to exterior surfaces from the post down. DO NOT apply to emitter screen or domes.

Storage:

Between uses:

- Turn Control Knob OFF.
- Disconnect LP source.
- Store heater upright in an area sheltered from direct contact with inclement weather (such as rain, sleet, hail, snow, dust and debris).
- If desired, cover heater to protect exterior surfaces and to help prevent build-up in air passages. Never leave LP cylinder exposed to direct sunlight or excessive heat.

Note: *Wait until heater is cool before covering.*

Service:

Only a qualified service person should repair gas passages and associated components.

Caution: *Always allow heater to cool before attempting service.*

TROUBLESHOOTING

If you have any questions regarding this product, please call our customer service hotline at 1-866-985-7877, 9a.m. – 6 p.m. (EST), Monday – Friday, or email us at cservice@welltraveled.net.

PROBLEM	POSSIBLE CAUSE	CORRECTIVE ACTION
Pilot won't light. Note: Heater operates at reduced efficiency below 40°F (5°C)	Cylinder valve is closed	Open valve
	Blockage in orifice or pilot tube	Clean or replace orifice or pilot tube
	Air in gas line	Open gas line and bleed it (pressing control knob in) for not more than 1 - 2 minutes or until you smell gas
	Low gas pressure with cylinder valve fully open	Turn cylinder valve OFF and replace cylinder
	Igniter fails	Use match or stick lighter to light pilot; obtain new igniter and replace
Pilot won't stay lit	Dirt build up around pilot	Clean dirt from around pilot
	Connection between gas valve and pilot assembly is loose	Tighten connection and perform leak check
	Thermocouple is not operating correctly	Replace thermocouple
Burner won't light	Gas pressure is low	Turn cylinder valve OFF and replace cylinder
	Blockage in orifice	Clear blockage
	Control knob is not in ON position	Turn control knob to ON
Burner flame is low	Gas pressure is low	Turn cylinder valve OFF and replace cylinder
	Outdoor temperature is less than 40°F (5°C) and tank is less than 1/4 full	Use a full cylinder
	Supply hose is bent or kinked	Straighten hose
	Control knob fully ON	Check burner and orifices for blockage
Carbon build-up	Dirt or film on reflector and burner screen	Clean reflector and burner screen
Thick black smoke	Blockage in burner	Remove blockage and clean burner inside and outside

Distributed By:
Well Traveled Living
716 S 8th Street
Amelia Island, FL 32034
Toll Free: 866-WTL-SUPP
(866-985-7877)



Web: www.wtliving.com
Email: cservice@welltraveled.net

1 YEAR LIMITED WARRANTY – Customers in the Continental US

All components are warranted for a period of 1 year after date of purchase by the original owner against defects in materials and workmanship under normal use. This warranty does NOT cover normal wear and weathering, assembly and/or maintenance OR use in a commercial application if model is not designated as a commercial model. At Well Traveled Living's sole discretion, products under warranty will be repaired and/or replaced at no charge to the customer. Any returns sent back to Well Traveled Living must be sent via prepaid freight and in the original retail packaging.

For warranty service contact Well Traveled Living at the address, phone numbers or internet site and email listed in this owner's manual. Be sure to have your sales receipt, date of purchase and catalogue/model numbers available when calling. All warranty service will be coordinated by the Well Traveled Living's, Amelia Island, Florida service center.

This warranty is extended only to the original purchaser. Proof of purchase will be required before warranty service is rendered. The sales receipt is the only valid proof of purchase. This warranty only covers failures due to defects in materials or workmanship which occur during normal use. Failures and/or damage which result from accident, negligence, misuse, abuse, neglect, mishandling, alteration or modification, failure to maintain, improper assembly or maintenance, service by unauthorized agency or use of unauthorized components or damage that is attributable to acts of God are NOT covered.

*****THERE ARE NO EXPRESS WARRANTIES EXCEPT AS LISTED ABOVE*****

*****PURCHASER ASSUMES ALL RISKS IN THE ASSEMBLY AND OPERATION OF THIS UNIT*****

*****FAILURE TO FOLLOW WARNINGS AND OPERATIONAL INSTRUCTIONS CONTAINED IN THIS MANUAL CAN RESULT IN SEVERE PROPERTY DAMAGE AND/OR PERSONAL INJURY*****

IN NO EVENT WILL WELL TRAVELED LIVING, OR ITS DIRECTORS, OFFICERS OR AGENTS BE LIABLE TO THE PURCHASER OR ANY THIRD PARTY, WHETHER IN CONTRACT, IN TORT, OR ON ANY OTHER BASIS, FOR ANY INDIRECT, SPECIAL, PUNITIVE, EXEMPLARY, CONSEQUENTIAL, OR INCIDENTAL LOSS, COST, OR DAMAGE ARISING OUT OF OR IN CONNECTION WITH THE SALE, MAINTENANCE, USE, OR INABILITY TO USE THE PRODUCT, EVEN IF WELL TRAVELED LIVING OR ITS DIRECTORS, OFFICERS OR AGENTS HAVE BEEN ADVISED OF THE POSSIBILITY OF SUCH LOSSES, COSTS OR DAMAGES, OR IF SUCH LOSSES, COSTS, OR DAMAGES ARE FORESEEABLE. IN NO EVENT WILL WELL TRAVELED LIVING, OR ITS OFFICERS, DIRECTORS, OR AGENTS BE LIABLE FOR ANY DIRECT LOSSES, COSTS OR DAMAGES THAT EXCEED THE PURCHASE PRICE OF THE PRODUCT.

SOME JURISDICTIONS DO NOT ALLOW THE EXCLUSION OR LIMITATION OF INCIDENTAL OR CONSEQUENTIAL DAMAGES, SO THE ABOVE LIMITATION OR EXCLUSION MAY NOT APPLY TO THE PURCHASER.

This limited warranty gives you specific legal rights and you may also have other rights which vary from jurisdiction to jurisdiction. The provisions of the United Nations Convention on Contracts for the Sales of Goods shall not apply to this limited warranty or the sale of products covered by this limited warranty.

*****IMPORTANT NOTICE*****

-Do **NOT** return to place of purchase-
For customer service and warranty issues
contact our Customer Service Center at:

(866)-985-7877 OR

Email: cservice@welltraveled.net

Customer Service Hours: Mon. – Fri. 9:00 a.m. – 6:00 p.m.
(EST)

Fire Sense®, Mojave Sun®, and Well Traveled Living® are registered trademarks of Well Traveled Imports, Inc®. All assembly instruction presentations are the property of Well Traveled Imports, Inc.® and are protected by U.S. copyrights and trademarks. All rights reserved.