



Upright Freezer

Service Manual

Models: PFV1375MW/PFV1376MS

Features

- Energy efficiency
- Micro foam technology
- Low noise operation
- Thick insulation for energy efficiency
- Latest No. 2 micro-biological technology

CONTENT

CONTENT



1. Content.....	1
2. Product code illumination and Series Introduction...	2
3. Specifications.....	3
4. Safety precautions.....	4
5. Function Schedule.....	7
6. System Flow Chart.....	8
7. Circuit Diagram.....	9
8. Maintenance Service and Trouble Shooting.....	10
9. Exploded View.....	30
10. List of Parts.....	31

Specifications

Models	PFV1375MW/PFV1376MS
Net capacity (L)	391
Color	White/Silver
Power Supply (V/Hz)	115V/60HZ
Rated Input Power (W)	130
Power Consumption (kW·h/24h)	1.07
Net Weight (kg)	69
Gross Weight (kg)	75.4
Unit Dimension (D*W*H) (mm)	711x750x1550
Packing Dimension (D*W*H) (mm)	765*799*1646
Container Quantity 40'HQ (PCS)	66

Safety precautions

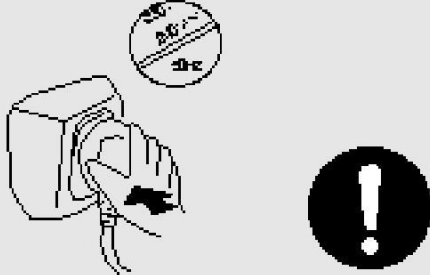
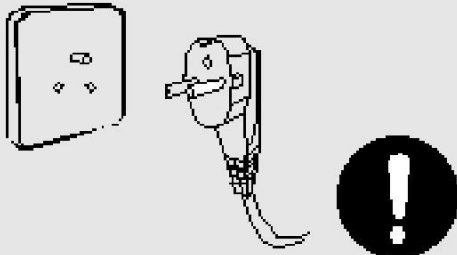
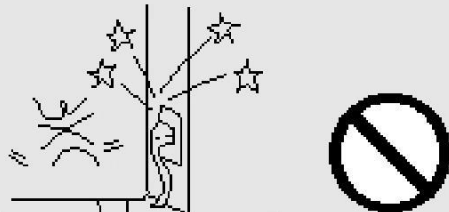
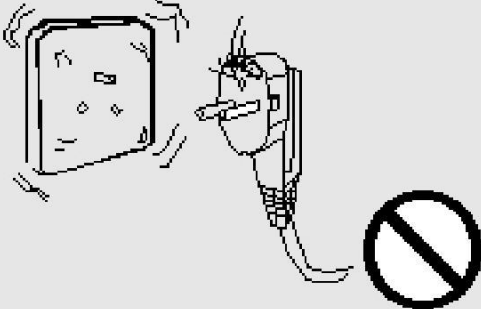
Safety precautions

<p>This appliance uses 115V/60Hz for power supply.</p> <p>Failure in operation and damage to the control panel, thermostat or the compressor will occur if voltage is</p> <p>Outside the range 97~126V unless a regulator with a capacity of over 700W or higher is installed</p> 	<p>It is required to use separate, dedicated outlet with securely grounding.</p> <p>The power cable of this appliance is fitted with three-core (grounding) plug complying with three-core (grounding) outlet. In no case, should the third plug pin (grounding) of the power cable be cut or removed</p> 
<p>Do not damage power cable</p> <ul style="list-style-type: none"> Be sure not to pull out the plug of the appliance by drawing the power cable. Be sure to directly pull out it of the outlet by firmly grasping the plug Do not cause the appliance body press the power cable, nor should any people tread on it When moving the appliance from wall, be careful not to roll or damage power cable 	<p>In case of damaged power cable</p> <p>When the power cable or plug has been worn, it is prohibited to continue to use it. In this case, it is required to replace it by factory authorized service shop</p> 
<p>When there is leakage of inflammable gas:</p> <ul style="list-style-type: none"> Close the valve of leaking gas Open doors and windows Neither try to drag nor insert any power plug for any electrical unit such as refrigerator 	<p>Please pull out power plug under the following situations:</p> <ul style="list-style-type: none"> Pull out power plug prior to cleaning or repairing When replacing damaged lamp, it is required to pull out power plug to prevent electrical shock 

Safety precautions

It is absolutely prohibited to put inside the appliance hazardous inflammable or explosive articles, strong corrosive acid, alkali, etc.



Do not keep medicine, vaccine, or chemical reagent in the appliance. This refrigerator is for household use, which cannot store item with strict requirement for temperature.



Do not store or use gasoline or other flammable article in the vicinity of the refrigerator to avoid fire.



Do not place any electrical plugs, regulators or microwaves on top of the refrigerator. Do not use electric appliances (Except those allowed by manufacturer) inside the refrigerator.



Do not play by hanging on its door, to prevent tilting the door or toppling the refrigerator to hurt person.



Do not place heavy or unstable articles or water containers on top of the refrigerator.



Safety precautions

When the refrigerator has started running, take care not to touch the cold surface of the freezer compartment with hand, especially with wet hand. Otherwise, your skin is liable to be stuck on the cold surface.



Do not spray water onto the refrigerator, or place it in wet area susceptible to be splashed with water, so as to avoid influencing the electric insulation performance of the appliance.



It is strictly prohibited to privately dismantle or change the appliance. For the repair of refrigerator, it can be carried out by professional only.



Do not put the bottled beer or beverage in the freezer compartment to prevent frost crack.



At no power supply or when carrying out cleaning, it is required to pull out the power plug, and to wait at least 5 minutes for switching on it again to prevent damaging its compressor by continuous starting.



When the appliance is to be discarded, dismantle its door, as well as its door gasket to avoid accident occurred when a child goes inside for playing.



Function Schedule

- **Energy efficiency**
- **Micro foam technology**
- **Low noise operation**
- **Thick insulation for energy efficiency**

System Flow Chart

System Flow Chart

1 Schematic diagram of System Flow Chart

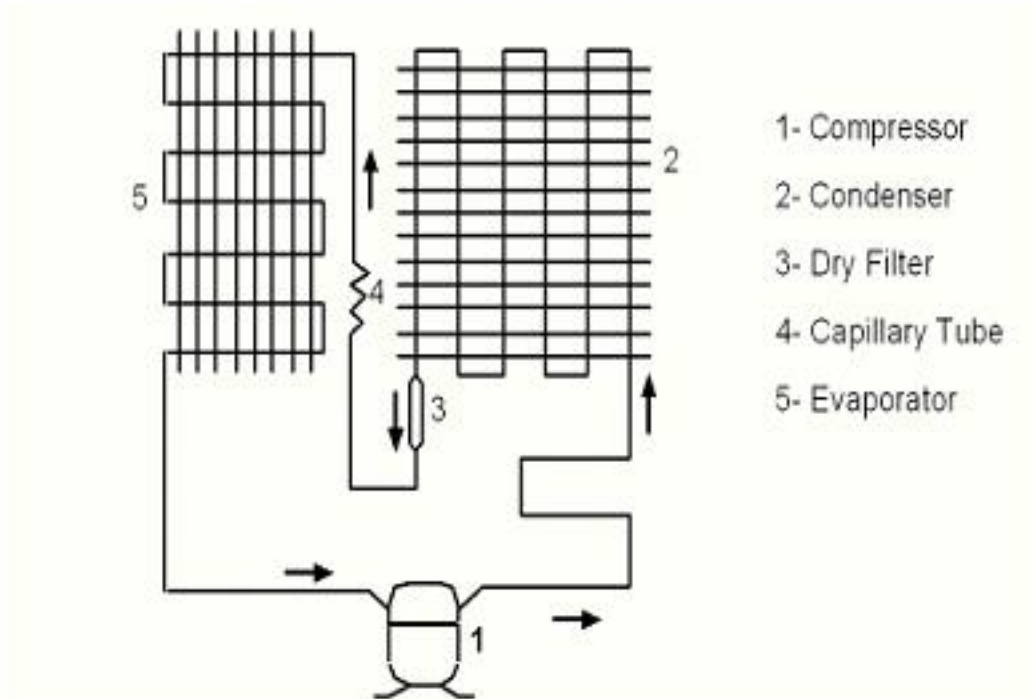

2 Brief Description of System Flow Chart

This model is a direct cooling single-system refrigerator.

When the refrigerator is just powered on, the refrigerant flows in the sequence: 1->2->3->4->5>1

Circuit Diagram 1 Schematic

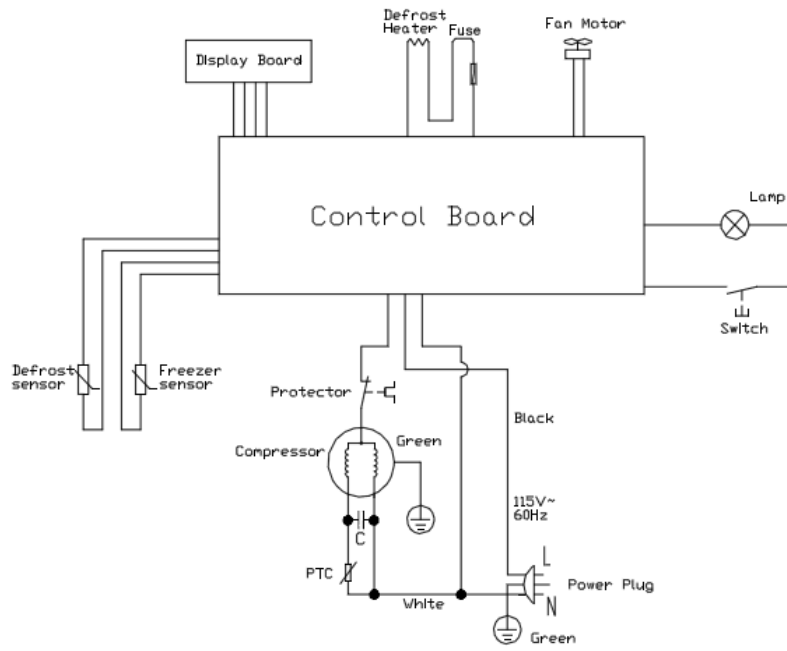

it Diagram

Brief Description of Control Principle
 This model is a No-frost Refrigerator-Freezer.

Maintenance Service and Trouble Shooting

1. No cooling

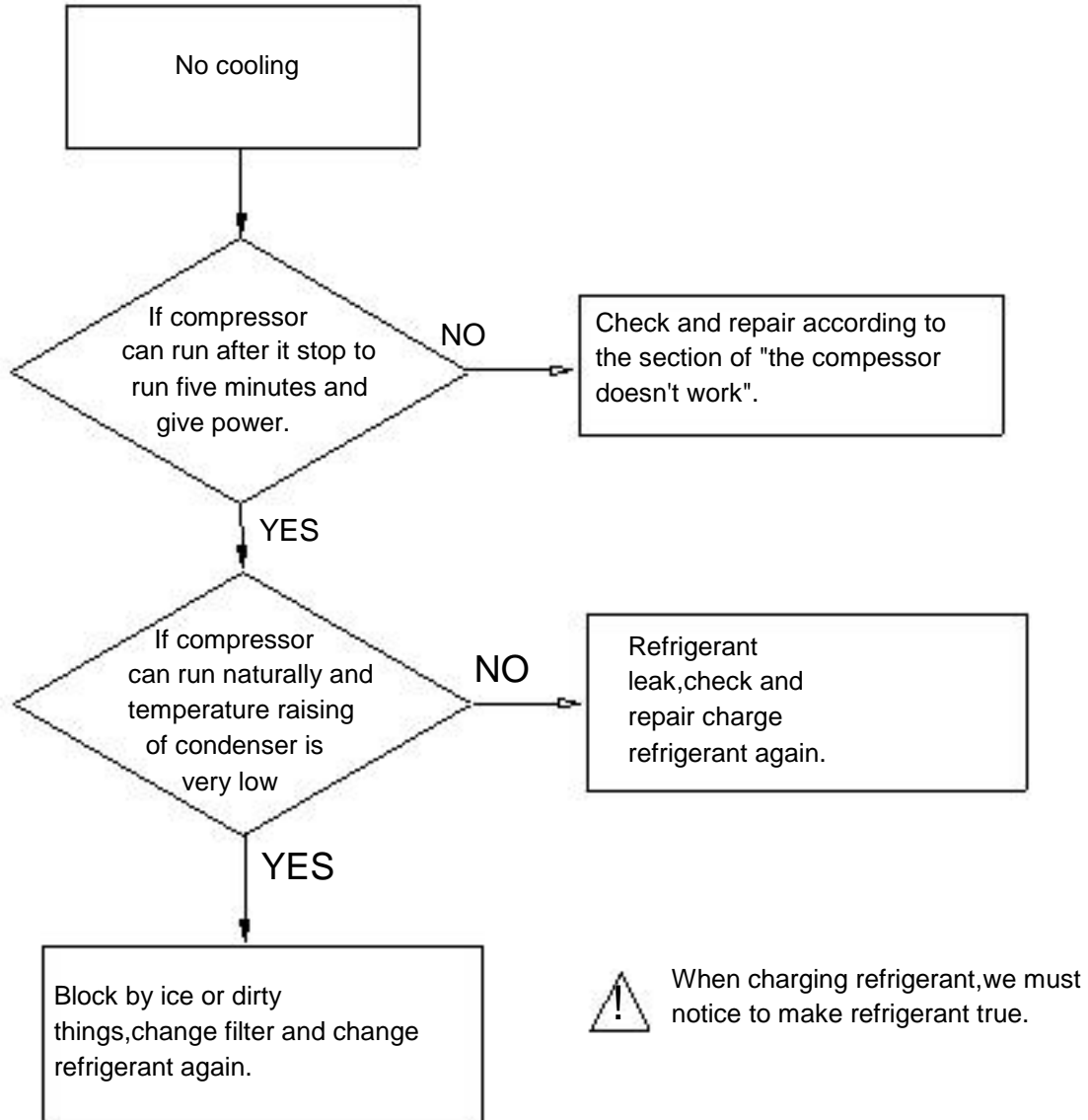

2 The compressor doesn't stop

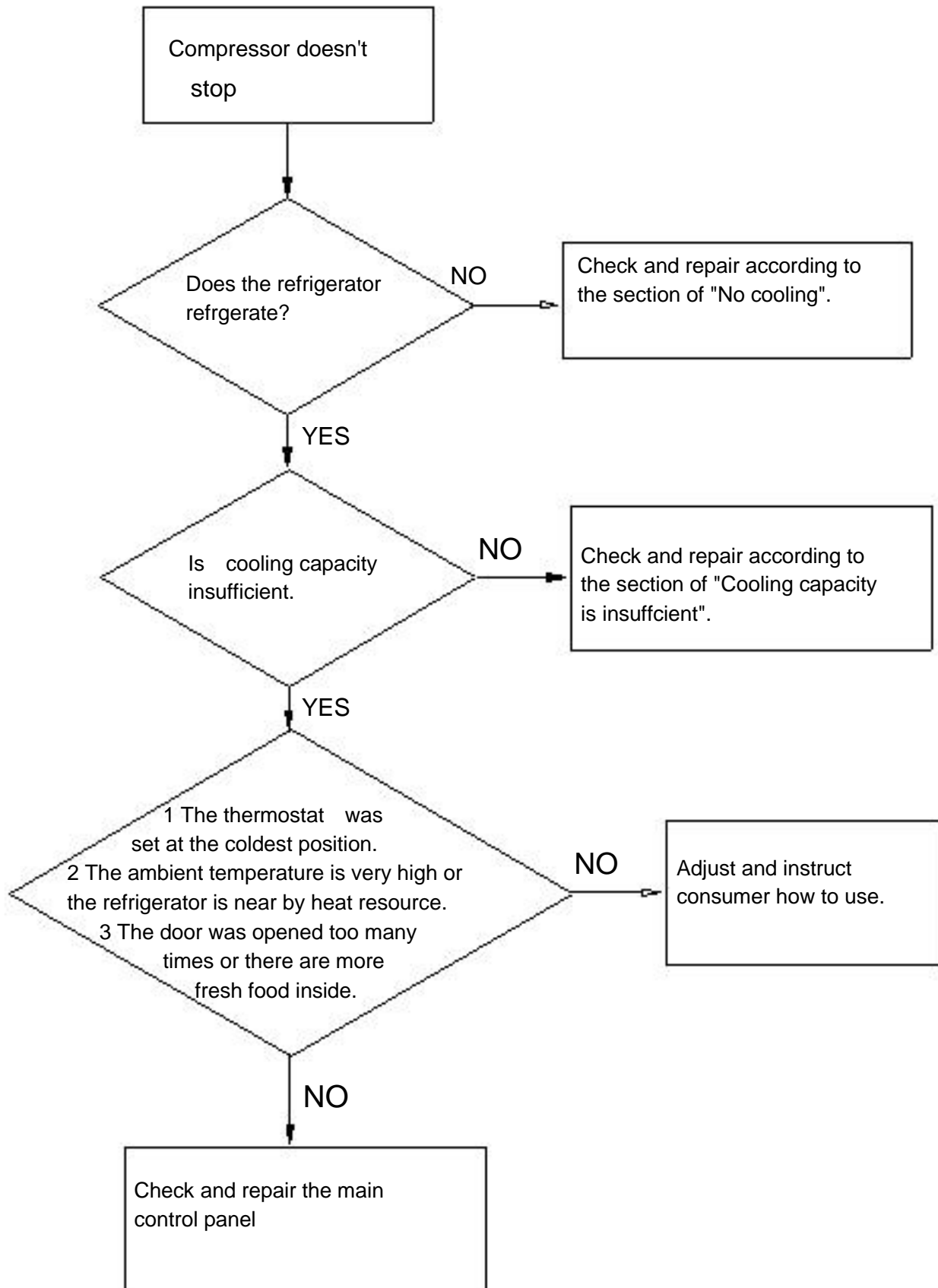

3 Cooling capacity is insufficient

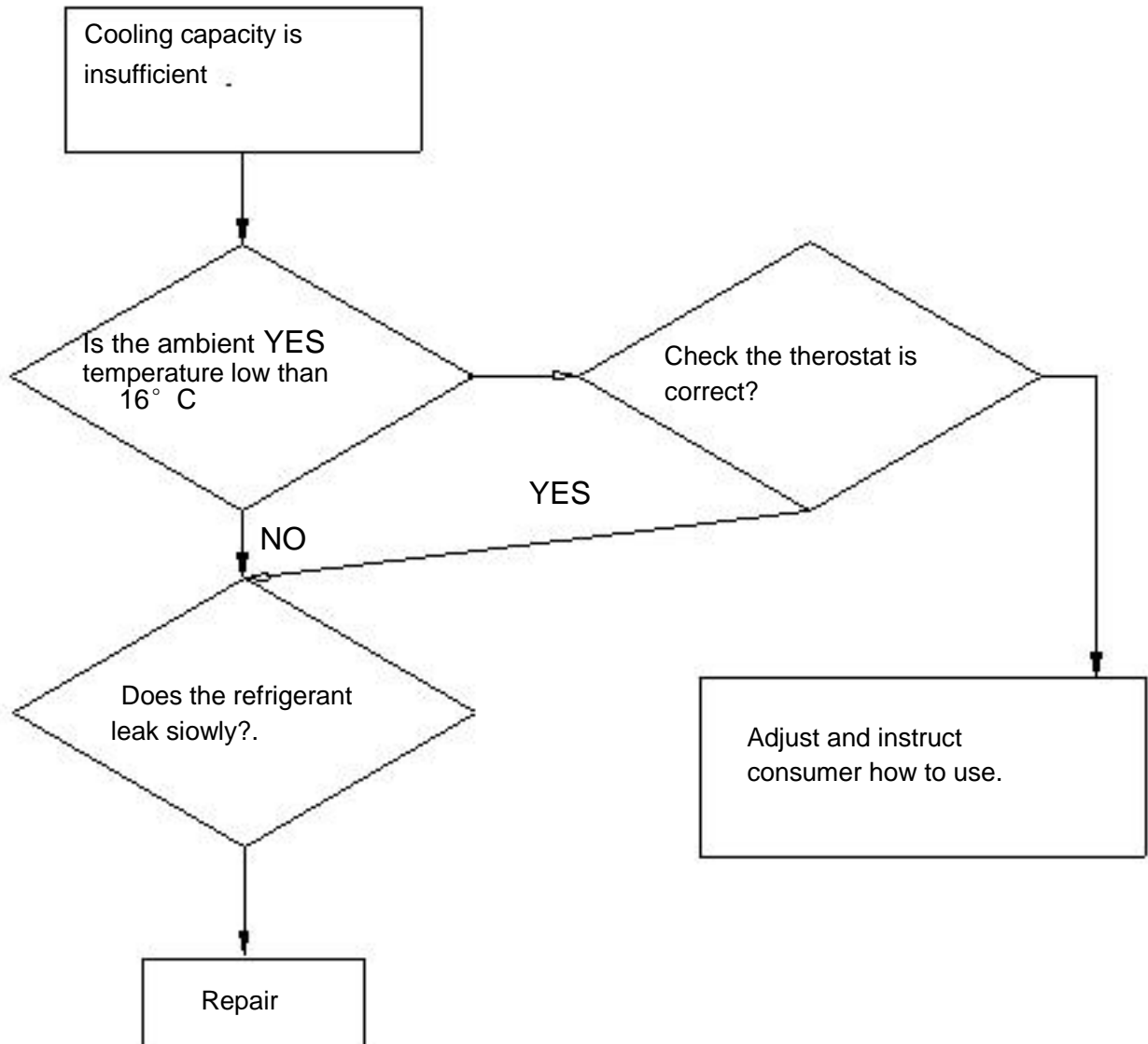

4 The compressor doesn't work

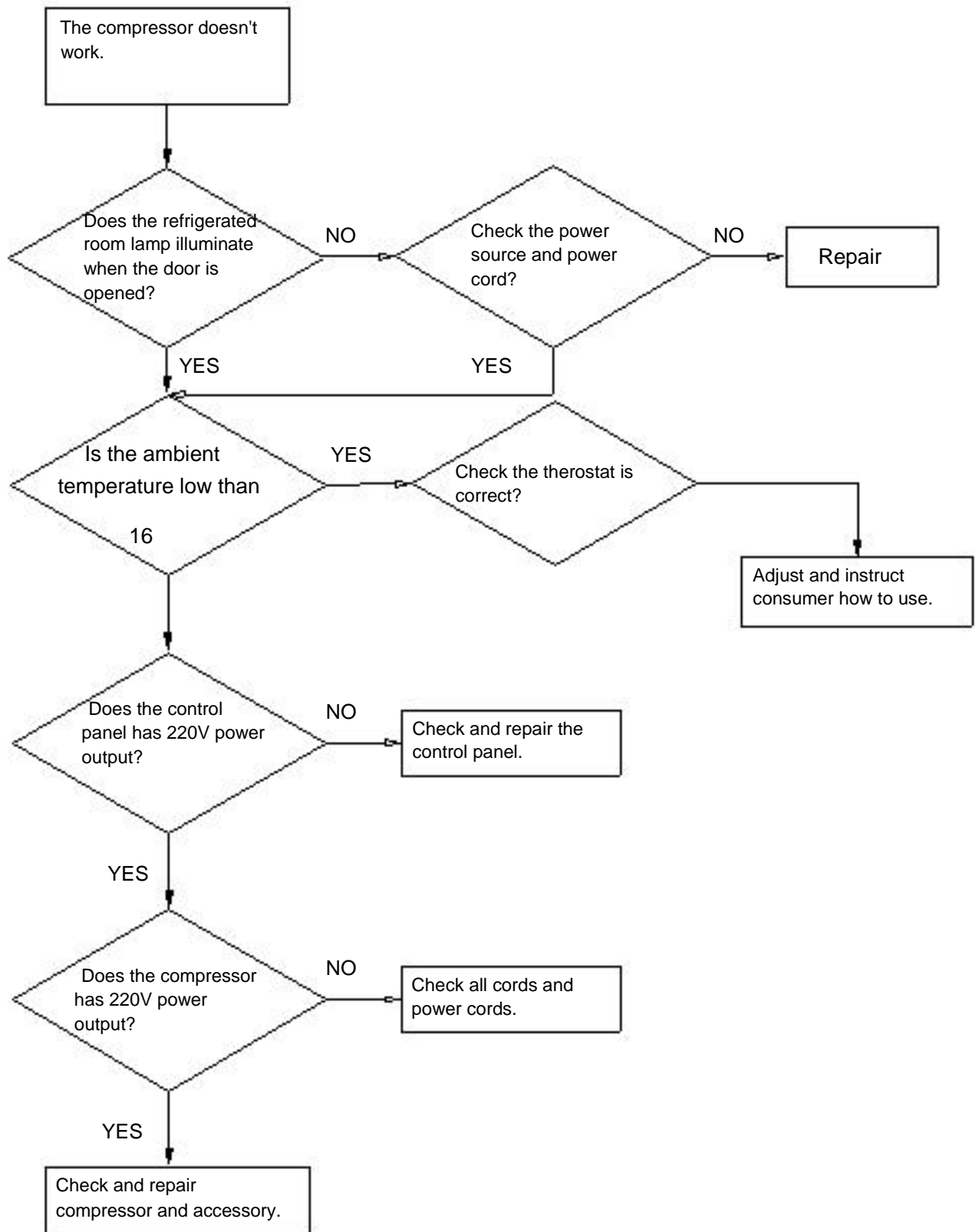

Maintenance Service and Trouble Shooting

5 Normal Phenomena—Not Troubles for Refrigerators

In a domestic refrigerator, there is not only a complicated electric control system, but also a refrigerating system that is difficult to discern whether it is in a good working condition. Both the systems are related and affect each other. If a certain part of a refrigerator works abnormally, its refrigerating efficiency will decrease, operation properties will become unstable, or even it cannot be used normally for those serious cases.

Refrigerators are generally of larger volume, once troubles appear, to send them to a service department is really a tough thing, if such is the case, the user will always be in suspense, sometimes, normal phenomena will be erroneously regarded as troubles. Therefore, before we deal with the topics of frequently occurring troubles of refrigerators and their remedies, we should firstly give a brief account of some normal phenomena which are not troubles. In case any one of such phenomena occurs, there is no need to worry about it, and the user can use it at total ease.

1). When the compressor of a refrigerator has just stopped running, a rumbling sound can be heard from inside its evaporator. This is a sound caused by the flowing of refrigerant in the evaporator tubing. Because the pressure difference is still greater after the compressor has just stopped running, the refrigerant will flow for a certain time, therefore, this sound is a normal phenomenon.

2). A click sound can often be heard from the refrigerator. This is a normal sound produced by the pull-in or release of the armature of a current deadweight start relay when starting the compressor. The compressor motor will produce a slight and uniform sound while it is running. This sound is not easy to be heard in the daytime, but of course it can be heard distinctly at night.

3). The compressor consists of an electric motor and a compressing apparatus. During its normal operation, the motor's stator core and windings will rise to a temperature in the range of 100°C ~ 110°C , and the temperature of the piston and cylinder of the compressing mechanism can also reach as above 100°C due to the heat produced when compressing refrigerant. Most of the heat radiates to the air through the compressor casing, therefore, its casing is generally at a temperature between 85°C ~ 90°C

, it is very hot, particularly in summer when the ambient temperature is higher. All these are normal phenomena.

4). For the direct cooling refrigerator, a kind of irregular crack sound can be often heard when the compressor is running for a certain period of time or has just stopped its running. This sound is caused by the stress relief due to expansion and contraction when temperature changes, and will not affect the normal application of refrigerator.

Maintenance Service and Trouble Shooting

6 Common Troubles in Refrigerators and Their Remedies

Causes for troubles occurring in refrigerators are closely related to the quality of components and workmanship in assembling by manufacturers as whether refrigerators are properly used and maintained. The parameters generally used to express the working conditions of a refrigerator include the temperature inside the refrigerator, operation rate, electric power consumption, noise level, and other functional indexes. If any one of these parameters is beyond its permissible range, this indicates that there is a fault or trouble in the refrigerator.

During the whole service life of a refrigerator, the probability of troubles occurring within a union time is called its failure rate. Making a comparison between the control circuit system of a refrigerator and its refrigerating system, we can find that the failure rate of the former is higher, and that of the thermostat is the highest. In troubleshooting, the first thing you must do is to determine where the trouble comes from --- the control system or the refrigerating system. There is general no trouble indicating instrument mounted on the domestic refrigerator, locations and natures of troubles should be determined according to their respective features, therefore, experience in servicing is very important to troubleshooting. Service technicians with rich experience can correctly locate them and take reasonable remedy measures based on their comprehensive analysis of trouble characteristics as well as operating conditions for various kinds of refrigerators.

Three Essentials for Checkup

1) Look

- a) Check the tubing of refrigerating system for cracks and various welding points for leaks; if leakage occurs, an oil stain can be seen definitely.
- b) Check the suction and exhaust pressure values (high pressure and low pressure) of compressor to see whether they are normal.
- c) Check the conditions of frost attached to its evaporator and gas return tube. It is abnormal if frost has formed on part of the evaporator or there is no frost attached to it.
- d) Pay attention to the speed of temperature drop inside freezer compartment. It is abnormal if the speed of temperature drop is obviously slower than the corresponding normal speed.
- e) Check the environment to see whether it is suitable for placing a refrigerator.
- f) Check refrigerator door seal, case, table surface and heat insulation layer.
- g) Look at the main control board to ascertain if various indication states are normal.

2) Listen

- a) Listen to the noises produced when the compressor is running

Maintenance Service and Trouble Shooting

Hums from a fully enclosed aggregate unit is the sound caused by overload indicating that the motor cannot be started normally ,meanwhile ,a clattering sound can be heard from inside the start relay ,which is produced because the start contacts cannot be released normally .A whistling sound is caused by the high pressure gas flowing out of the crack of the pressure tube inside the compressor ,and clucks are the sound of striking after the suspended spring inside the compressor has broken .

During the normal operation of compressor, a slight and uniform hum sound due to undulation of electric current can be heard generally ,this is a normal phenomenon .However ,if it sounds like "tong ,tong ...",i.e., an impact sound inside the compressor ,this means that a large quantity of wet vapour of refrigerant or refrigerating oil has come into the compressor cylinder ;if it sounds like "dang ,dang...", a striking sound of metal parts inside the compressor ,this means that some moving parts have loosened (note to differentiate this sound from those formed during starting or stopping the compressor).

b) Listen to the sound caused by the flowing of gas in the evaporator

Open the refrigerator door while the compressor is in operation, incline your ear and listen attentively the gas flow sound inside the evaporator .If it sounds like gentle whistling accompanied by a sound similar to water flowing ,this is the sound produced by the normal circulation of refrigerant within the evaporator .In case only the gas flowing sound can be heard and there is no water flowing sound ,this indicates that the refrigerant has already percolated .If neither the flowing sound nor the gas sounds from the evaporator can be heard ,this means that the filter or capillary has been clogged .

3)Touch and Feel

a) Feel the compressor when running ,its temperature should be generally less than 90° C in the normal state (it may exceed 90° C in case of running for a longer period of time).

b) After the compressor has operated normally for 5~10 minutes , touch and feel the condenser ,the temperature of its upper part should be higher than that of its lower part (or its right part is hotter than its left part ,depending on the type of condenser coil),this indicates that the refrigerant is circulating . If the condenser is not hot ,this means the leakage of refrigerant .In case the condenser radiates heat for only several minutes and then cools down ,this means that the filter and capillary have been clogged .As for the forced air cooling condenser ,hot air will be blown out of it ; this means that the system is out of order .

c) Feel the filter's temperature .During the normal operation of refrigerating system ,the temperature on the filter's surface should be a little higher than the ambient temperature ;if you touch it with your hand ,you will have a sense of slight heat .In case dew condensation appears due to the fact that its temperature is obviously lower than the

Maintenance Service and Trouble Shooting

ambient temperature ,this means that most meshes of its screen has been clogged ,resulting in an obstructed flowing of refrigerant ,thus causing a drop in temperature due to throttling .

d) Feel the temperature of exhaust gas from the refrigerating system .the exhaust gas should be very hot and this is the normal working state .For those refrigerator with enclosed type of compressor refrigerating system, no frost or dew drop will form on the gas suction tube ,otherwise ,there is something wrong in the system (Frosting and dew condensation may appear for a very short time period when just starting the machine ,this is a normal phenomenon).

Because a refrigerator is a combination of several components ,they are related and have influence on each other In case an abnormal phenomenon has been found through the above-mentioned checkups ,you need not to make a hasty conclusion based on only one abnormal phenomenon .It is advisable to find out two or more abnormal phenomenon ,or conduct troubleshooting comprehensively with the aid of instruments or other ways ,because several kinds of troubles may share a common abnormal phenomenon ,and two or more abnormal phenomena may occur simultaneously due to a certain trouble .With this method ,you can reject some suspicious troubles and finally make a correct judgment .

7 Analysis of Troubles and Troubleshooting

A. Poor Refrigerating Effect

The so-called "poor refrigerating effect " refers to the fact that the refrigerator can operate and refrigerator normally ,but the temperature in the refrigerator cannot drop to the prescribed value under the stipulated working conditions .In view of there are many causes for this phenomenon ,we are going to discuss and analyze it in the following 7 aspects :

1) Leakage of refrigerant

Analysis of Trouble

The leakage of refrigerant in the system will result in an insufficient refrigerating capacity ,the resulting phenomena are its lower gas suction pressure and exhaust pressure as well as higher exhaust gas temperature. The exhaust tube feels rather hot ,and a continuous gas flowing sound louder than usual can be heard at the outlet of the capillary ,and no frost or a smaller quantity of loose frost appears on the evaporator .After shut down ,the balance pressure in the system is usually lower than the saturation pressure corresponding to the same ambient temperature .

Remedy

In case there is leakage of refrigerant from the system ,do not hurry to recharge it with refrigerant ,manage to find out leak points immediately ,and make a note of from where it leaks ---welding points and parts .After having them repaired ,recharge refrigerant .

Maintenance Service and Trouble Shooting

There are so many joints and sealed surfaces in a refrigerator, accordingly, quite a lot of potential leak points do exist in the system. In troubleshooting, pay attention to those parts that are liable to leak, check main connection points for oil seepage and tubing for cracks. If there is no severer leak point, charge the system with nitrogen and detect leak points with the commonly adopted method, repair them, evacuate, charge the system with refrigerant, and then turn on the refrigerator to make a test run.

2) Too much refrigerant charged into the system

Analysis of Trouble

a) In case the amount of refrigerant charged into the system exceeds its nominal capacity, the superfluous refrigerant will of course take some space of the evaporator, thus reducing its heat-dissipation area and hence the refrigerating efficiency of the system. The abnormal phenomena caused by this reason are as follows: the gas suction and exhaust pressures are generally higher than their respective normal values, the temperature of its condenser is higher and the electric current of the compressor rises, loose frost forms on the evaporator, the refrigerator temperature drops slowly, and frost appears on the gas return tube.

b) In case excessive refrigerant has been charged, the liquid refrigerant that cannot evaporate in the evaporator will return to the compressor, and thus a phenomenon of "liquid striking" will occur. The liquid refrigerant evaporates and effervesces as soon as it flows into the refrigerating oil at the bottom of compressor. If the condition is severe, foams will fill all over inside the compressor housing and be sucked by the piston, causing damage to the components of compressor.

Remedy

According to the operating procedures, it is mandatory to turn the machine off, and several minutes later, open the refrigerant charging tube and let the refrigerant escape from it, replace the dry filter, recharge refrigerant after evacuating, and then seal the charging port.

3) There is air left in the refrigerating system

Analysis of Trouble

Residual air in the refrigerating system will reduce its refrigerating efficiency. The prominent phenomena are the increase in its gas suction and exhaust pressures (however, the gas exhaust pressure will not exceed its rated value), obvious increase in temperature in the segment from the compressor outlet to the condenser inlet. Because there is air in the system, both the gas exhaust pressure and temperature will rise, and moreover, the gas flowing sound is intermittent and obviously louder.

Remedy

After shut down for several minutes, open the tubing, evacuate it and then recharge the system with refrigerant.

4) Low efficiency of compressor

Maintenance Service and Trouble Shooting

Analysis of Trouble

Low efficiency of a refrigerating compressor refers to the actual reduction of gas discharge capacity ,and hence the corresponding reduction of refrigerating capacity ,under the condition that the refrigerant in the system is unchanged .This phenomenon occurs mostly when the compressor has been used for quite a long time ,its moving parts have worn to a considerable degree ,fit clearance between various parts have increased and sealing property of its gas valve has deteriorated ,resulting in an decrease in its actual gas discharge capacity .

Methods of Judgment

Measure the high and low pressures with pressure gauges to see whether they are normal .If an abnormal sound comes from the compressor or the temperature of its causing is too high ,Cut the discharge port open and operate the compressor ,feel it if there is pressure at the discharge port with your finger (For a normal compressor ,its discharge port is difficult to be blocked with your finger if you just apply a little effort).

5) Too thick frost layer formed on evaporator

Analysis of Trouble

If a direct cooling refrigerator is to be used for a prolonged period of time ,be sure to defrost its evaporator regularly ;if you fail to do so ,the frost layer on the evaporator tubing will become thicker and thicker .Heat conduction will be severely affected when the whole tubing is wrapped with a transparent ice layer ,and finally the temperature in the refrigerator cannot drop down to the prescribed range .

Remedy

Turn the refrigerator off , and make preparations for defrosting ,open the refrigerator door to let the air come in ,or use a fan to speed up air flowing so as to shorten the time needed for defrosting .Never strike the frost layer with any iron tools or wood stick in order to avoid damage to the evaporator tubing .

6) Refrigerating oil left in evaporator tubing

Analysis of Trouble

During the process of refrigerating cycles , a little refrigerating oil may remain in the evaporator tubing ,and after a longer time of operation ,if there is considerable refrigerating oil left in the evaporator ,the heat conduction effect will be severely affected ,thus causing a poor refrigerating effect .

Remedy

It is quite difficult to determine whether this trouble is caused by the refrigerating oil left in the evaporator tubing ,because this kind of phenomenon and other several trouble are tends to be confused .Generally speaking ,you can make a judgment based on the frost formed on the evaporator .If the frost does not cover the evaporator , and moreover ,it is loosely formed ,you can make a judgment that the deterioration of

refrigerating effect is due to the accumulation of refrigerating oil left in the evaporator tubing in case no other troubles have been found . To clear off refrigerating oil left in the evaporator ,dismantle the evaporator ,purge it thoroughly and then dry it .In case it is difficult to dismantle it ,charge refrigerant from the evaporator inlet to wash it several times ,then purge and dry it with nitrogen .

7) Flowing obstructed in refrigerating system

Analysis of Trouble

Because the refrigerating system was originally not purged thoroughly ,some of the filter screen meshes have been clogged by dirt accumulated in the filter after using it for a certain time of period ,thus resulting in a decrease in flow rate ,and hence a poorer refrigerating effect .

The abnormal phenomena caused by this kind of slight clogging in the system are as follows: the gas discharge pressure is lower ,the temperature of discharged gas drops down ,the position clogged has a temperature lower than that in normal conditions ,and for a severe clogging ,even dew condensation as frosting may appear .

Remedy

Purge the tubing , and after replacing the dry filter with a new one or clearing it thoroughly ,recharge the system with refrigerant and seal the charging port .

B. No Refrigerating

The phenomenon that the compressor runs normally , but no frost (or only a little frost) appears on the evaporator ,and the refrigerator temperature does not drop down is called "no refrigerating". There are many causes for this trouble and it is relatively complicated , too . In servicing ,special attention to finding direct causes for this phenomenon .Three main potential causes for this trouble are analyzed below :

1) All refrigerant in the system has leaked out

Analysis of Trouble

Leak points in the refrigerating system have not been found and repaired timely ,thus resulting in the total escape of refrigerant .There are two kinds of leakage :i) **slow leakage** for instance ,when we want to use a refrigerator that has been put out of quite a long time ,we find the leakage of refrigerant ,or in the course of its operation ,we have found that the refrigerator is gradually becoming not so cold and finally no refrigerating can be achieved ; ii) **fast leakage** in that case ,all the refrigerant will escape swiftly due to abrupt rupture of system tubing .

Symptoms of total leakage of refrigerant are mainly as follows : the compressor can be started easily (if there is no damage to the compressor parts) and its operating current becomes low ,its gas suction pressure is high and discharge pressure is lower ,the gas discharge tube feels rather cold ,no sound of gas eruption from the liquid in the evaporator can be

Maintenance Service and Trouble Shooting

heard ,and no will gush out of the process tube if you cut it open after shutdown .

Remedy

Check the whole machine , particularly those locations which are liable to leak .After leak points have been found ,repair them or replace them with new parts according to specific circumstances ,then evacuate the system and finally charge refrigerant.

2) Refrigerating system has been clogged

a) Clogged with Ice

Analysis of Trouble

The dryness treatment for the major parts in the refrigerating system has been performed improperly, the effect of air purging for the whole system is not good ,or the water content in the refrigerant is out of standard ,all these will cause the expansion valve to be clogged with ice .The symptom for this trouble are as follows :the refrigerator sometimes can refrigerate and sometimes cannot :the refrigerator compartment works normally at the beginning ,but after working for a certain period of time ,frosting begins at the clogged position ,evaporation temperature reaches below 0°C , water will accumulate at the narrow part of the capillary and clog it gradually ,then frost begins to melt at the evaporator ,no gas flowing sound can be heard ,and the gas suction pressure assumes a state of vacuum .Note that these phenomena will appear intermittently ; sometimes ,the refrigerator works well ,and sometimes not well .In order to determine whether it is clogged with ice ,heat the suspicious points with hot water to make ice melt ,and after a while if a gas flowing sound resulting from an abrupt gush is heard and the gas suction pressure rises as well ,it can be confirmed that the trouble is caused by ice clogging .

Remedy

If there is too much moisture in the refrigerating system, it is advisable to release the refrigerant, purge the tubing with nitrogen, and then charge the system with the filtered refrigerant. However, the commonly adopted method is to connect a filter with moisture absorbers (such as silica-gel, anhydrous calcium chloride) to the refrigerating system so as to filter out the moisture from the system, then replace the filter, evacuate it again and finally charge the system with refrigerant.

b) Clogged with dirt in capillary

Analysis of Trouble

The capillary inlet is a place where coarse-grained dirt or refrigerant oil in the system will tend to settle down and clog it. In case considerable dirt accumulates there, the whole filter screen may be blocked totally, making the refrigerant unable to go through. Clogging with dirt exhibits the same symptoms as that with ice, namely, higher gas suction pressure, lower temperature of discharged gas, and no gas flowing sound from the evaporator. The difference between the both is as follows: if the clogging is

Maintenance Service and Trouble Shooting

caused by dirt , tapping the suspicious clogged point (generally in the capillary or the connection joint of the filter) may cause the refrigerant to flow through partially, resulting in some corresponding change, whereas in that case if you heat it with a hot towel, no reaction will happen, no flowing sound can be heard, moreover, there is no periodic change. After rejecting the possibility of ice clogging, it can be generally considered as the clogging due to dirt .

Remedy

Dismantle the system, remove the dry filter from it, purge the tubing with nitrogen, install a new filter, then evacuate it and finally charge it with refrigerant.

C) Clogging in filter

Analysis of Trouble

Total clogging of a filter is rarely to occur. This trouble is mostly caused by the paste-like matter formed from the substances filled into the system or other dust after the refrigerator has been used for a longer time, or by the dirt accumulated gradually inside the filter. Sometimes, tapping the filter may cause a passage for flowing, Touching it with your hand, you will feel that it is cooler compared with its temperature in the normal state.

Remedy

The same as described in the capillary clogging with dirt.

3) Troubles of Compressor

a) Breakage of gas suction and discharge valve blocks

Analysis of Trouble

The compressor works by means of the opening and closing of gas suction valve and discharge valve to suck and discharge the refrigerant. If the valve block is broken, the refrigerant can not be discharged, and hence no refrigerating can be achieved.

Method for making judgement

It is quite difficult to differentiate this trouble from others because they often have similar symptoms. In repairing, firstly, hear attentively if there is some abnormal sound coming from the compressor (sometimes , the broken pieces of valve block may strike against the cylinder), and feel the compressor casing with your hand to ascertain whether it is too hot, this is also helpful to the troubleshooting; secondly, measure the pressures at the high and low pressure ports of the compressor with pressure gauges, if the gas suction valve block is broken, the suction pressure gauge pointer will swing violently and the suction pressure is very high, whereas when the gas discharge valve block is broken , the discharge pressure gauge pointer will swing drastically and the discharge pressure is very high. In the both cases, stop the compressor at once, and if technique is available, open the cylinder cover and check up the valve block, repair it, or replace it with a new one,

C. Sudden stop of Compressor during Its Running

Maintenance Service and Trouble Shooting

The cause of sudden stop of a compressor during its running is mostly that the gas suction pressure and/or discharge pressure exceed their respective prescribed ranges, thus making a pressure-operated protective relay shut off the power to the compressor and stop it. In the following we discuss mainly the reasons for causing excessively high gas discharge pressure and low suction pressure.

- 1) Stoppage due to excessively high gas discharge pressure
 - A) Too much refrigerant charged into the system

Analysis of Trouble

The phenomenon, such as loose frosting and poor refrigerating effect, may occur if excessive refrigerant has been charged into the system. Superfluous refrigerant will occupy a certain space of the evaporator, thus reduce its heat dissipating area, and the phenomenon of "liquid striking" may occur, too. Meanwhile, dew or frost condensation may occur on the gas return tube, and the gas discharge pressure will obviously rise, when it reaches the threshold value, the protective relay will actuate and shut off the power supply to the compressor.

Remedy

Open the tubing, re-evacuate and then charge the system with a proper quantity of refrigerant.

- b) Air left in the system

Analysis of Trouble

The residual air in the system will circulate together with the refrigerant in the system. The major symptoms caused by this residual air is higher gas discharge pressure, higher discharged gas temperature (the gas discharge tubing is considerably hot when you feel it with your hand), and poorer refrigerating effect. Furthermore, the gas discharge pressure will exceed its normal value when the compressor has run for a period not too long, thus making the protective relay actuate and bring to a stoppage.

Remedy

Check up how the air has been left in the refrigerating system. Generally, there are two possibilities: one is that the air has been sucked into the system when repairing due to carelessness, or it has not been purged out totally when evacuating the system; the other is that there are leak points at the low pressure end of the refrigerating system. Leak points appear mostly in those low temperature parts or assemblies, because the evaporation temperature is lower for such low temperature devices, especially at the low pressure end, it is easier for the air goes into the system. Once it has been ascertained that air does exist in the system, you have to open the tubing, re-evacuate it and then charge it with refrigerant.

- 2) Stoppage due to electric troubles
 - a) Thermostat is out of control

Analysis of Trouble

In case the thermostat does not work in its good order or its

Maintenance Service and Trouble Shooting

temperature sensor has not been installed properly, frequent stoppage is also likely to occur.

Remedy

Try to adjust the temperature sensor's position until the compressor can be started and stopped normally. If this cannot be achieved, and the stoppage still occurs repeatedly, it is most likely that the mechanical parts or contacts are out of order, disassemble the thermostat, make a thorough checkup and repair it.

b) Overload of electric motor

Analysis of Trouble

Probably, too many things have been put into the refrigerator, and hence the thermal load exceeds its refrigerating capacity ; or in case the power supply voltage drops considerably, the current flowing through the motor will increase drastically making the thermal protector actuate and the fuse blown , and hence the motor stops running. If the motor is still running continuously in such a case , its windings will be burned out .

Remedy

Reduce the thermal load, pay attention to the variation in voltage of the power supply.

c) Abnormal thermal protection

Analysis of Trouble

The compressor current is within its normal range, but the thermal protector actuates repeatedly.

Remedy

Replace the thermal protector with a new one.

3) Sudden stoppage due to other causes

Normal Stoppage

Start and stop of the compressor is generally controlled by a thermostat . When the temperature in the refrigerator reaches its desired value, the thermostat will shut down the compressor automatically. Never take this normal operation as a trouble, care should be taken to differentiate it from other real troubles in servicing.

D. Compressor won 't start

In case the compressor cannot be started, you must find out the origins of this trouble through checkup step by step, because probably there are many causes, including those electrical and mechanical.

1) Inspect the power supply to see whether it is connected to the compressor circuit.

Analysis of Trouble

In case the compressor cannot be started, this will generally exhibit in the power supply circuit, for instance, power failure, poor contact of switch, and blown fuse. Make a comprehensive analysis of these phenomena, fine out its real cause and take correct measures to remove this trouble.

Remedy

Maintenance Service and Trouble Shooting

a) Check the input power circuit to see whether where is voltage of the power supply, namely, the circuit which is connected to the knife switch. This can be determined with an avometer or a test pencil. If a blown fuse is found, ascertain and remove its cause, then replace it with a new one of the same specifications.

b) Check the compressor accessories, including its thermal protector and relay. In case the thermal protector is damaged, the compressor cannot be powered on. If the relay is out of order, the motor will not run and hum sound can be heard from it after the compressor is turned on, in that case, shut it down immediately, otherwise, the motor windings will be burned out in case this condition lasts longer.

c) Check the relay contacts and plugs to see if they are perfect and work reliably. Poor contact may cause the motor not running or humming.

2) Check the circuit voltage to see whether it is normal.

Analysis of trouble

If the circuit voltage is obviously lower than its rated value, it will be difficult to start the motor, and a hum sound can be heard from it.

Remedy

Measure the voltage with a voltmeter, if it is really too low, give directions to the user for buying a stabilizer so as to step up the voltage, thus normal operation can be achieved.

3) Check the thermal relay to see whether its contacts are closed.

Analysis of Trouble

The contacts of thermal relay sometimes may be open due to the leakage of temperature sensing agent from the temperature sensor.

Remedy

Remove the relay cover to check up its contacts, if they are open, this means that the original setting is not properly set or temperature sensing agent has leaked out of the temperature sensor. Try to turn the adjusting stem of this value in the direction of the lower temperature graduation, then check the contacts to see whether they are closed. If they are still not closed, dismantle the temperature sensing disc and then immerse it into warm water to see whether the contacts actuate, if not, it can be preliminarily determine that temperature sensing agent has leaked out, and it must be replaced with a new thermostat.

4) Motor troubles and other electric faults

a) Motor windings have been burned or short-circuited between turns

Analysis of Trouble

When motor windings have been burned or short-circuited between turns, the fuse will be blown repeatedly, and the blowout occurs particularly at the instant when you close the knife switch.

Remedy

Check the terminals and the outer casing to see whether they are short-circuited, and measure the resistance of each phase with an

Maintenance Service and Trouble Shooting

avometer. If short circuit occurs or the resistance of a certain phase is low, this means that short circuit does exist in the windings and/or between turns, and insulation layers have been burned or deteriorated. A megameter can be used in this inspection, too. If the insulation resistance is lower than $2\text{ M}\Omega$, this means that the insulation layer is already breakdown. If the motor has been burned, repair it or replaced it with a new one.

b) Fault of control relay

Analysis of Trouble

Overheat, burnout or wear of control relay contacts may occur generally. All these will cause poor contact in electricity.

Remedy

Dismantle it to repair, or replace it with a new one.

c) Poor electric contactor in thermostat

Analysis of Trouble

Burnout of contactor and leakage of temperature sensing agent may occur generally.

Remedy

Replace the old with a new one.

d) Check the terminals for loose connection and electric circuits for other abnormal phenomena.

5) Mechanical faults of compressor

a) Seizing of shaft

This phenomenon is caused mostly by poor lubrication, such as insufficient quantity of lubricant, clogging in the lubricant oil line, or intermittent lubricant oil supply. Dirt and other impurities in the lubricant oil will increase its viscosity and cause the shaft to be seized. Copper plating may also result in seizing of shaft.

b) Seizing of piston

This is caused by too small fit clearance between the piston and cylinder or expansion due to heat.

Judgement of seizing shaft and piston: After the refrigerator has been powered on, the compressor will not start and run, but a slight hum sound can be heard, and several seconds later, thermal protective relay will actuate and make the contacts open; this process will occur repeatedly, but the compressor cannot be started.

E. Compressor won't stop

Sometimes, the compressor will run continuously (for several hours or run without end), If the food placed in the refrigerator is not too much, there may be the following two situations: i) the refrigerator very low, this means that the control system is probably out of order; ii) the control system works normally, and there are troubles in the refrigerating system or other parts.

1) Temperature is set improperly

a) The temperature control knob is set to the "coldest" position. This

Maintenance Service and Trouble Shooting

position is to be used for fast freezing or continuous running, its temperature for power off is too low, therefore, the compressor won't stop and the temperature in the refrigerator becomes lower and lower .

b) Inspection method: check the temperature control knob to see whether it is set in the position "coldest".

2) Thermostat is malfunctioning and makes the compressor running continuously

Analysis of Trouble

When the thermostat doesn't work normally, it will make the compressor run continuously, and hence very low temperature will be achieved in the refrigerator. The fault is generally due to the fact that the contacts of the thermostat cannot be released.

Remedy

Dismantle the thermostat and make a through checkup, if it is totally out of functioning, replace it with a new one.

3) evaporation temperature is too high in refrigerating system, resulting in lower refrigerating capacity and hence continuous running of compressor

Analysis of Trouble

Leakage of refrigerant and clogging in a refrigerating system will directly affect its refrigerating capacity. Due to the reduction in its refrigerating capacity, the refrigerator temperature cannot reach its rated value, the thermostat won't work, thus the compressor runs continuously. When the evaporation temperature in the system is too high, the temperature sensing agent in the temperature sensor is also hotter, therefore, the thermostat is unable to cut off the power supply to the compressor and stop it.

Remedy

If it has been found that the refrigerant in the system is insufficient in quantity, recharge it with refrigerant. In case clogging occurs, disassemble the part where it is blocked. If the evaporation temperature is too high, settle this problem with an appropriate quantity of refrigerant.

4) No stoppage of compressor due to damaged heat-insulation layer inside case body and/or door seal

Analysis of Trouble

When the heat-insulation layer inside the case body deteriorates or the door seal is not closely touches the door frame, the temperature in the refrigerator will rise and makes the compressor running continuously.

Remedy

Check the heat-insulation layer for its damaged parts, repair it to improve its heat-insulation property. If the door has deformed or the door seal is not tightly sealed against the case body, repair them, respectively.

5) Too much food is placed in the refrigerator, or is placed too densely, resulting in poor ventilation or poor conditions for temperature sensing, and hence no stoppage of the compressor.

6) Too high ambient temperature, poorer ventilation and heat

Maintenance Service and Trouble Shooting

dissipation make the compressor running without stop.

F. Electric leakage of refrigerator

1) Slight electric leakage

Electric insulation has deteriorated due to being affected with damp, thus resulting in slight electric leakage.

2) Serious electric leakage

Refrigerator case has become live due to faults occurred in some electric devices or the erroneous wiring in installing power cord plug or outlet by the user. This is very dangerous.

3) Electric leakage test

a) Slight electric leakage

A tingle sense will be experienced as soon as you touch the metal parts of the refrigerator with your hand .When you test them with a test pencil ,its neon lamp will come on .In that case ,the first thing you need to do is to determine whether the grounding is perfect .If the grounding is no problem ,turn off the refrigerator immediately ,then check the insulation of electric circuits with an avometer .

b) Serious electric leakage

Never touch the case body of the refrigerator ,its door handle or other metal parts with your hand .Test the refrigerator with a test pencil ,it will light up intensively ;measure the resistance between the power cord plug and the case body with an avometer ,the reading will be zero (0Ω); in the worst case ,the fuse will be blown .Check the 3-prong outlet to see whether the live wire and the null line are inversely connected ,this makes the ground protection lead-out from the power cord plug being connected to the live wire .Another possibility is that the live wire and null line of the outdoor power supply circuit have been inversely connected accordingly ,this makes the null line become a live wire .

G .Stronger vibration and loader noise

1) Refrigerator placed improperly

a) Uneven ground

Uneven ground will cause there frigerator to be placed unsteadily ,causing stronger vibration and noise during its operation .

b) Leveling screws not properly adjusted

If the leveling screws on refrigerator legs have not been adjusted properly ,vibration and noise will still occur even if the refrigerator has been placed on a level ground .

2) Abnormal noise from compressor

Three suspended spring inside the compressor case are out of balance ,and strike against the case ,moreover ,the wear of compressor parts may cause noise sometimes .

3) Resonance of tubing and loosening of parts

Improper and compact laying of tubes or the loosening of parts may cause vibration and noise .

Maintenance Service and Trouble Shooting

4) Inspection method

To find the sources of noise, press the vibration spot with your hand while the refrigerator is in operation and listen attentively whether the vibration becomes weaker or vanishes. If the refrigerator has not been levelly placed, put a level meter on its top table and adjust the leveling screws on its legs. In case noise occurs from the compressor, strike different locations on the side surface of its case using a rubber hammer or hand hammer with a wood block in-between so as to determine whether the suspended springs are out of balance or being seized.

